

# RADIANT COOKTOP 600 SERIES 30"







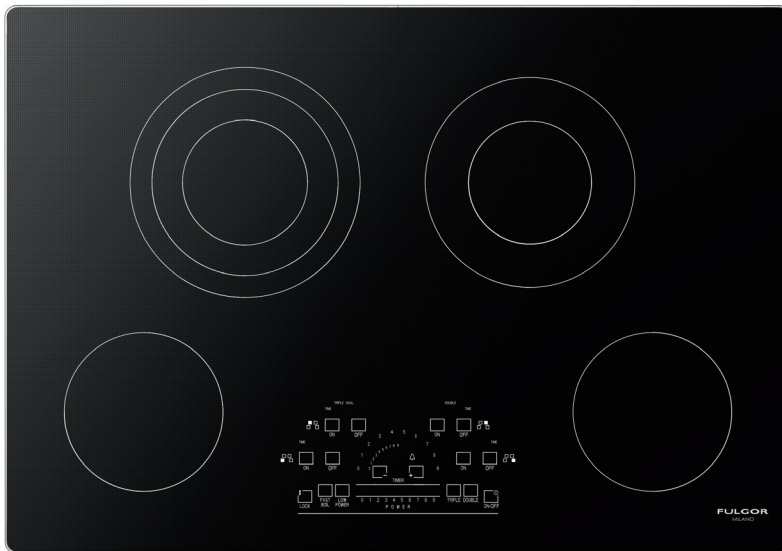

CODE ID

30" RADIANT COOKTOP WITH TOUCH CONTROL WITH BRUSHED ALUMINUM TRIM

**F6RT30S2**



-  Easy Clean Ceramic Glass
-  Slide Touch Control
-  Double Radiant
-  Triple Radiant
-  Timer
-  Residual Heat Sensor
-  Frame Creative

## RADIANT COOKTOP

Digital Display for Power Level  
Low Power Scale for Delicate Cooking  
Control Display Lock  
Automatic Fast Boil Function  
Power and Hot surface Indication  
Timer Functions  
Timer Display  
Acoustic Buzzer  
Independent timer for each zone.  
Booster function for each cooking zone  
Failure Codes Indication



This product meets ADA (Americans with Disabilities Act) requirements. Please check with your local municipality's codes and stipulations for additional details to ensure compliance.

# DISTINTO

30" RADIANT COOKTOP WITH TOUCH CONTROL WITH BRUSHED ALUMINUM TRIM

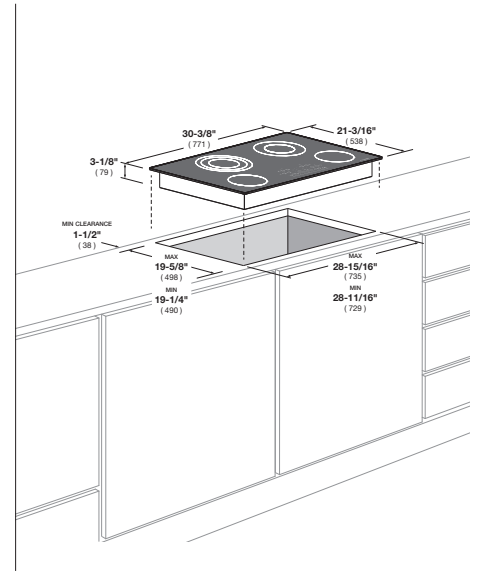

CODE ID		F6RT30S2 - 36" RADIANT COOKTOP WITH TOUCH CONTROL WITH BRUSHED ALUMINUM TRIM	
Series and Finish	600 Series - Ceramic glass with aluminum frame		
<b>CONTROL PANEL</b>			
Control Type	Touch Control		
<b>COOKTOP</b>			
Type	RADIANT		
Cooking Surface	Ceramic Glass		
<b>RADIANT COOKTOP FEATURES</b>			
Power Setting	Peacock Slider Touch Control		
Digital Display for Power Level	4		
Low Power Scale for Delicate Cooking	•		
Control Display Lock	•		
Automatic Fast Boil Function	•		
Hot Surface Indication	•		
Timer Functions	1+5		
Timer Display	•		
Acoustic Buzzer	•		
Failure Codes Indication	•		
Cooking Zones	4		
Burners types (Front-L) - Power	6"	(153 mm)	1200W
Burners types (Rear-L) - Power	9" / 7" / 5"	(230 mm / 180 mm / 127 mm)	2500W / 1600W / 800W
Burners types (Rear-R) - Power	8" / 5"	(203 mm / 127 mm)	2200W / 800W
Burners types (Front-R) - Power	6"	(153 mm)	1200W
<b>DIMENSIONS/WEIGHT</b>			
Overall dim - Width	30 - 3/8"	(771 mm)	
Overall dim - Height	3 - 5/16" + conduit 15/16"	(84 mm) + conduit (24 mm)	
Overall dim - Depth	21 - 3/16"	(538 mm)	
Cut-out - Width (min - max)	28 - 11/16", 28 - 15/16"	(729 mm) - (735 mm)	
Box - Height	3 - 1/16" + conduit 15/16"	(78 mm) + conduit (24 mm)	
Cut-out - Depth (min - max)	19 - 1/4", 19 - 5/8"	(490 mm) - (498 mm)	
Gross Weight	36 lbs	(16 kg)	
<b>POWER / RATINGS (208/240 V, 60 HZ)</b>			
kW / Amps rating at 240V, 60Hz	7.10kW - 29.6A		
kW / Amps rating at 208V, 60Hz	5.33kW - 25.6A		
Power Cable	Conduit		
<b>INSTRUCTIONS FOR USE</b>			
Use & Care Manual / Installation Manual	English / French / Spanish		