

ASSEMBLY INSTRUCTIONS

1015-3 FULL / FULL MISSION BUNK BED



Thank you for purchasing this quality product. Be sure to check all packing materials carefully. For small parts which may have come loose inside the carton during shipment. Separate, identify and count all parts and hardware. Compare with the parts list to be sure all parts are present.

**“DO NOT TIGHTEN SCREWS
UNTIL COMPLETELY ASSEMBLED”**

SIZE OF MATTRESS AND FOUNDATION (SUPPORT)

This bed is designed to use a full mattress (53 ½”-54 ½”x 74-75”) and bunkie board (53 ½”x 74”).

The total thickness must not exceed 9” inches. Do not use mattress without the proper bunkie board of safe foundation.

Note: There must be at least 5” inches from top surface of mattress to top edge of guardrails.

REPLACEMENT PARTS.

Replacement parts, including additional guardrails, may be obtained from place of purchase or original distributor.

TO OBTAIN PARTS, PLEASE CONTACT: **DONCO TRADING COMPANY - FORT WORTH, TEXAS**

SAFETY WARNINGS!

- 1-Follow the information on the warning label appearing on the upper bunk end structure and on the carton. Do Not remove warning label from bed.
- 2-Always use the recommended size mattress or mattress support, or both, to help prevent the likelihood of entrapment or falls.
- 3-Surface of mattress must be at least 5 inches below the upper edge of guardrails.
- 4-Do not allow children under 6 years of age to use the upper bunk.
- 5-Prohibit more than one person on upper bunk.
- 6-Periodically check and ensure that the guardrail, ladder and other components are in their proper position, free from damage, and that all connectors are tight.
- 7-Do not allow horseplay on or under the bed and prohibit jumping on the bed.
- 8-Always use the ladder for entering and leaving the upper bunk.
- 9-Do not use substitute parts. Contact distributor or dealer for replacement parts.
- 10-Use of night light may provide added safety precaution for a child using the upper bunk.
- 11-If the bunk bed will be placed next to a wall, the guard rail that runs the full length of the bed should be placed against the wall to prevent entrapment between the bed and the wall.
- 12-Always use guardrails on both long sides of the upper bunk.
- 13-The use of water or sleep flotation mattresses is prohibited.
- 14-Keep these instructions for future reference.
- 15-Strangulation Hazard-Never attach or hang items to any part of the bunk bed that are not designed for use with the bed: for example, but not limited to, hooks, belts, and jump ropes, etc.



IMPORTANT: PLEASE READ INSTRUCTIONS BEFORE STARTING THE ASSEMBLY

ASSEMBLY INSTRUCTIONS

1015-3 FULL FULL MISSION BUNK BED

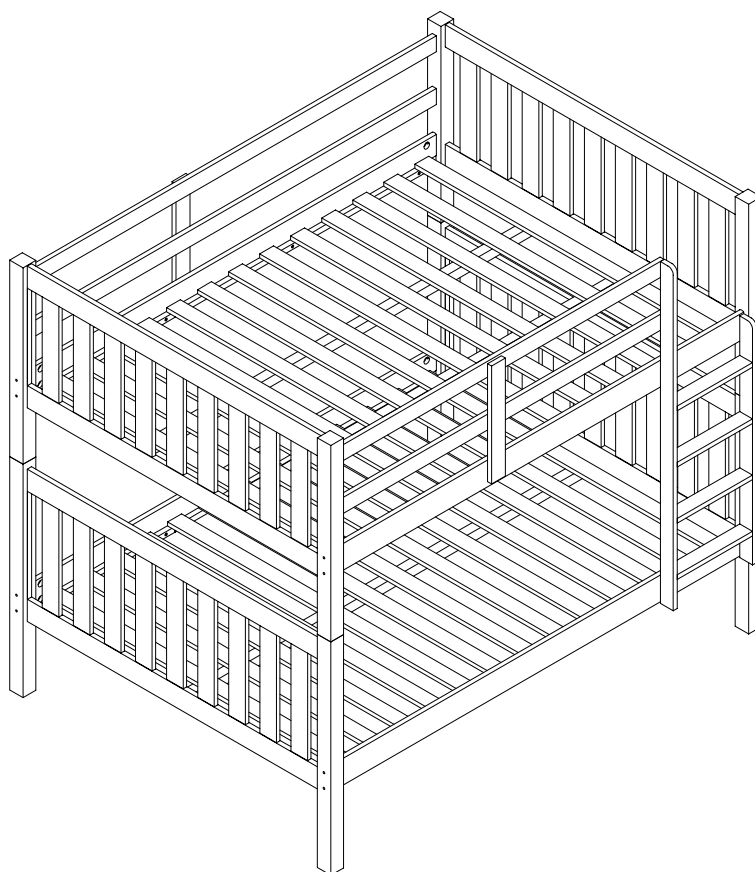

Thank you for purchasing this quality product. Be sure to check all packing material carefully for small parts which may have come loose inside the carton during shipment. Separate, identify and count all parts and hardware. Compare with the parts list to be sure all parts are present.
"DO NOT TIGHTEN SCREWS UNTIL COMPLETELY ASSEMBLED"



* Use of power tool to assemble this product will invalidate any claim and damage this product making unsafe !!!
* Please assemble on a clean soft surface to avoid damage.



Tool Required



(Phillips Key) (Hammer)
(Not Includ) (Not Includ)

IMPORTANT:
PLEASE READ INSTRUCTION BEFORE STARTING THE ASSEMBLY

Part List: 1015-3 FULL FULL MISSION BUNK BED

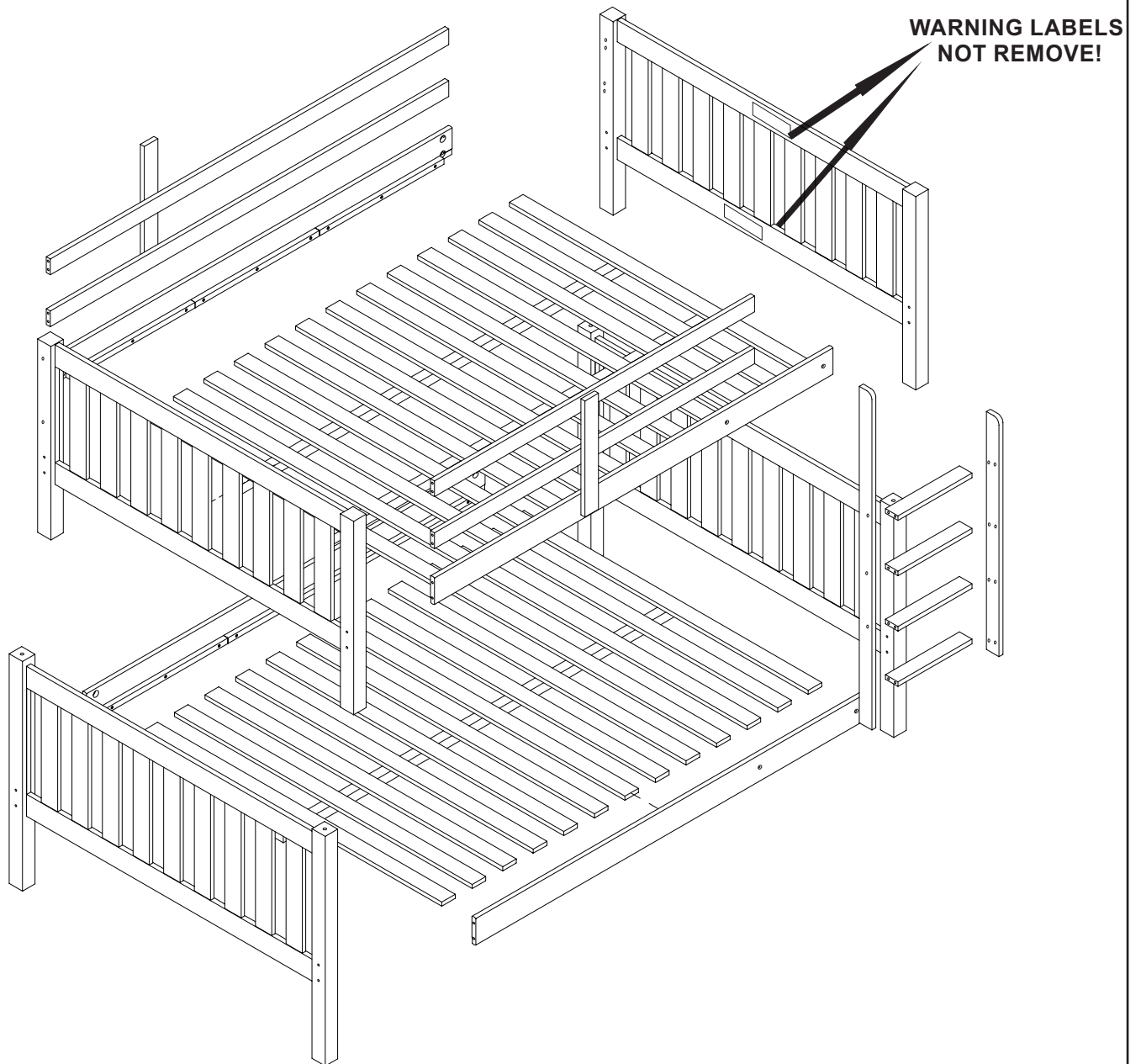

Identifying the Hardware/part list - Identify the hardware using the illustrations below.

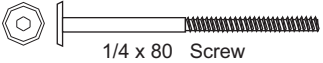
A  Qty **16**
1/4 x 80 Screw

B  Qty **16**
1/4" Half Moon

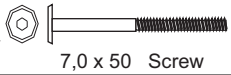
C  Qty **14**
7,0 x 50 Screw

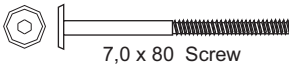
D  Qty **06**
7,0 x 80 Screw

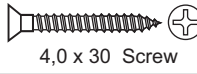
E  Qty **34**
4,0 x 30 Screw

F  Qty **01**
Allen Key

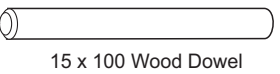
G  Qty **04**
15 x 100 Wood Dowel

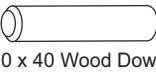
H  Qty **22**
10 x 40 Wood Dowel

I  Qty **06**

J  Qty **36**
3,5 x 16 Screw

01

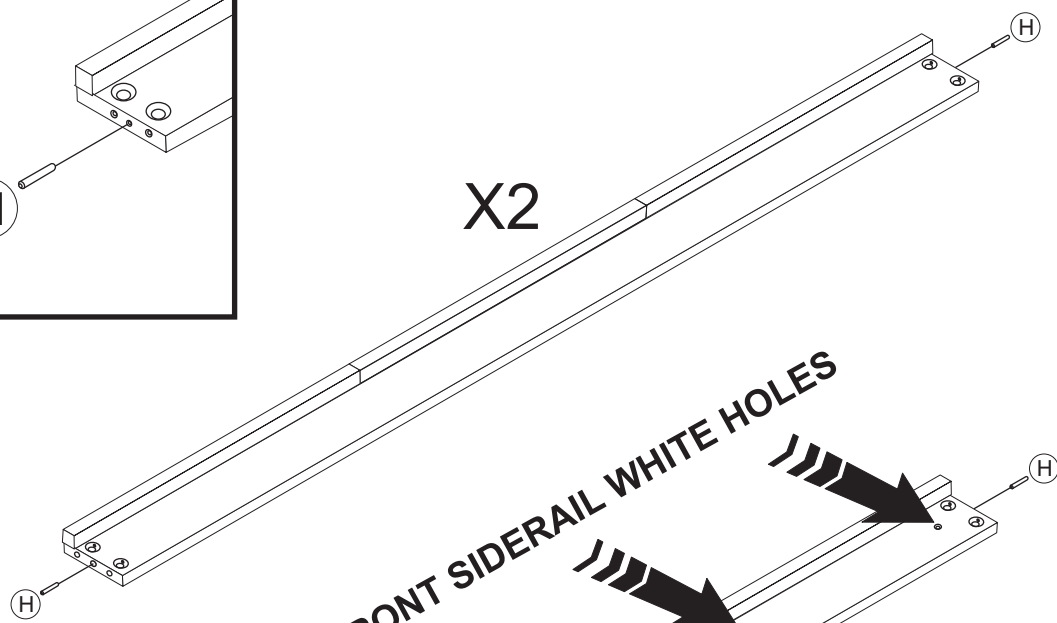
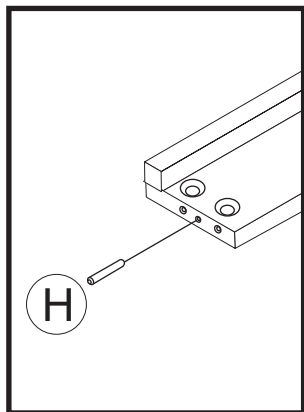

FRONT SIDERAIL WHITE HOLES

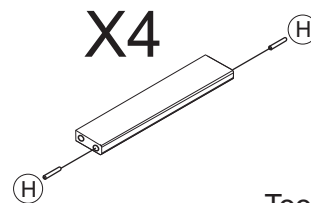
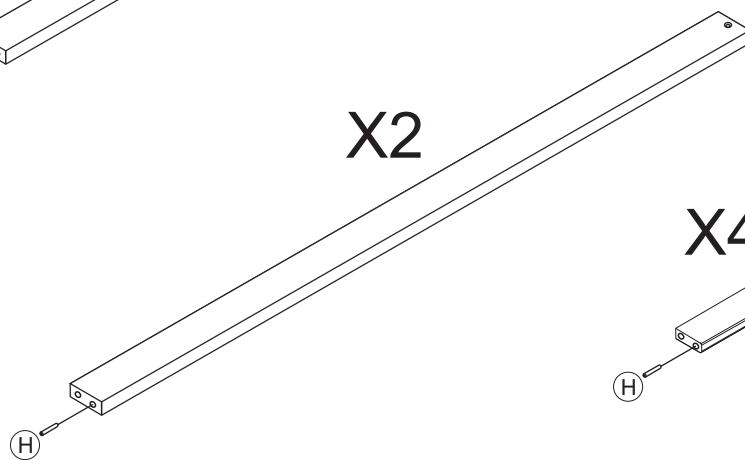
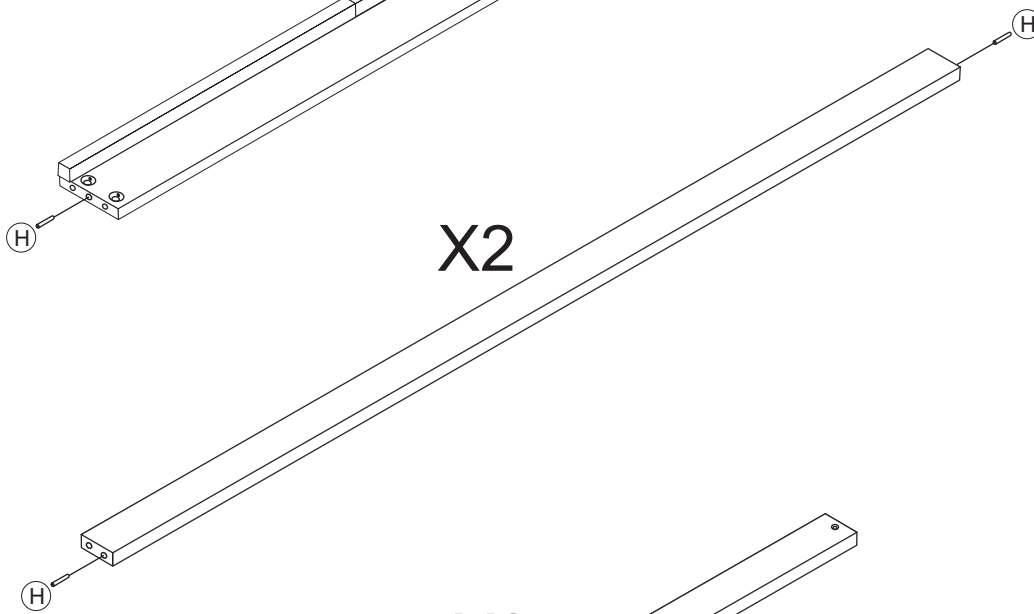
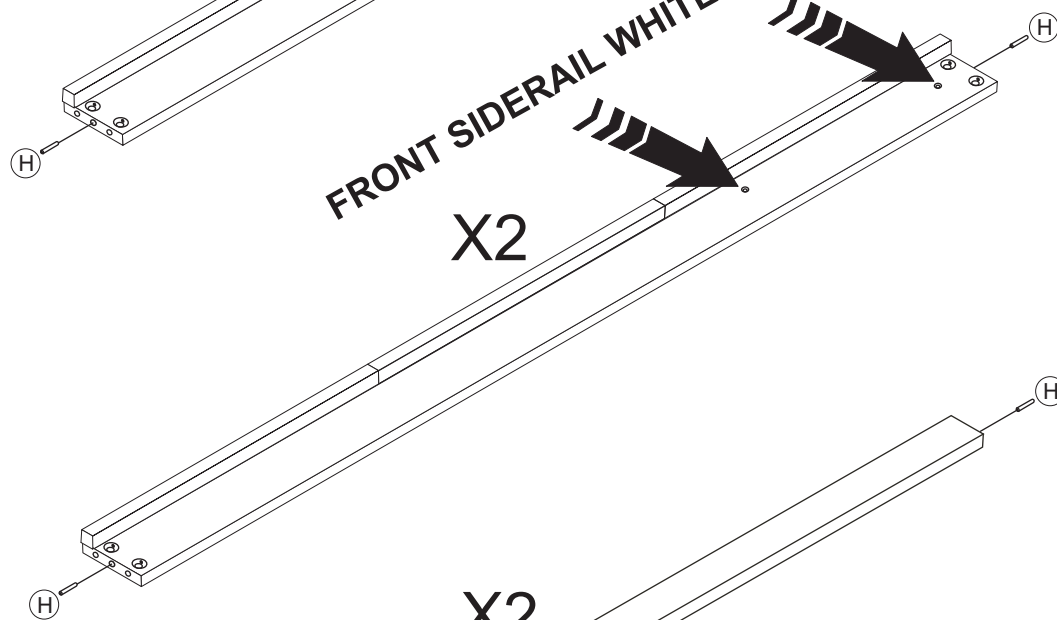

Tool Required

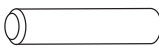

H		Qty
	10 x 40 Wood Dowel	22

02 BOTTOM BED

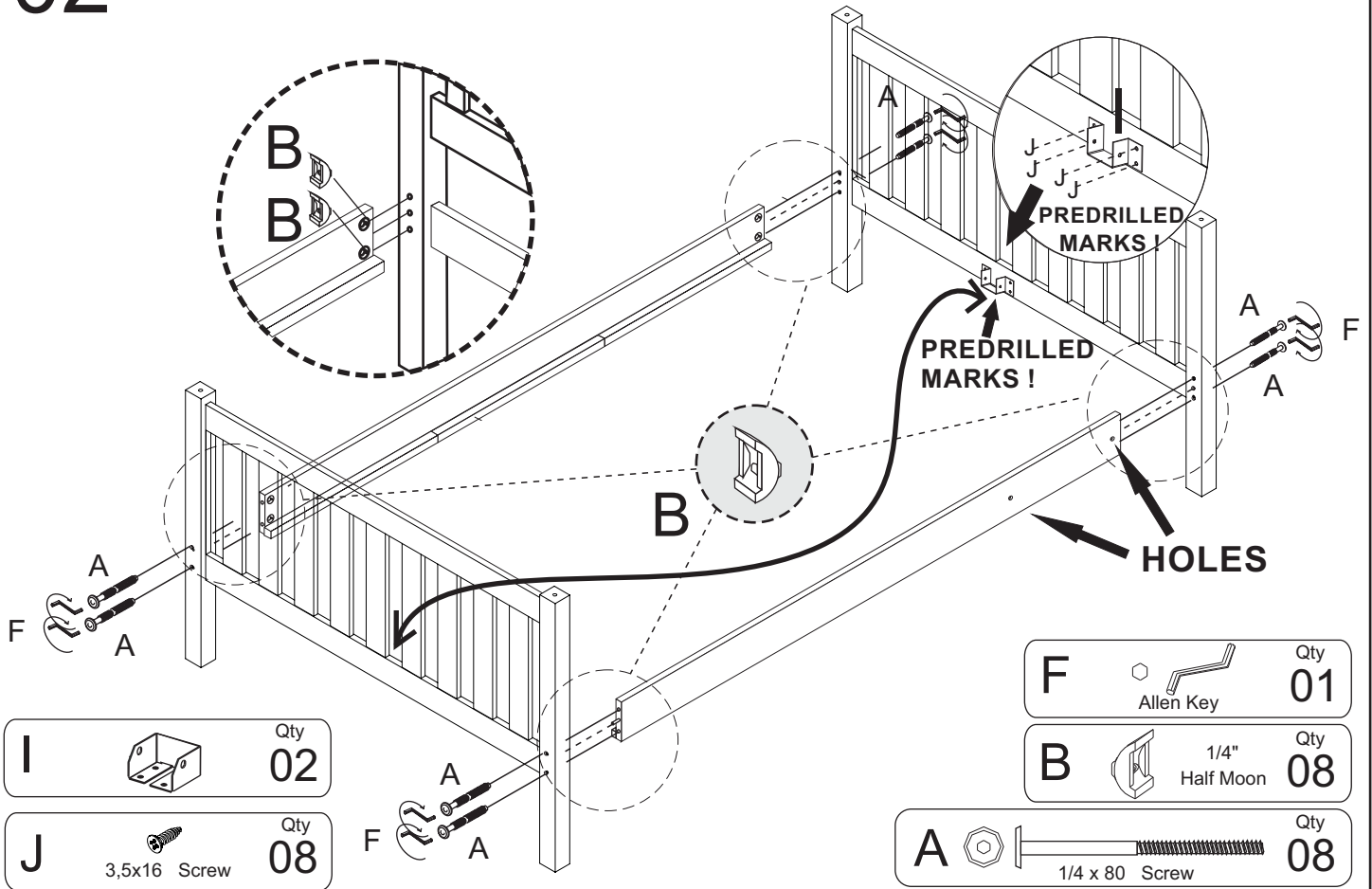

03

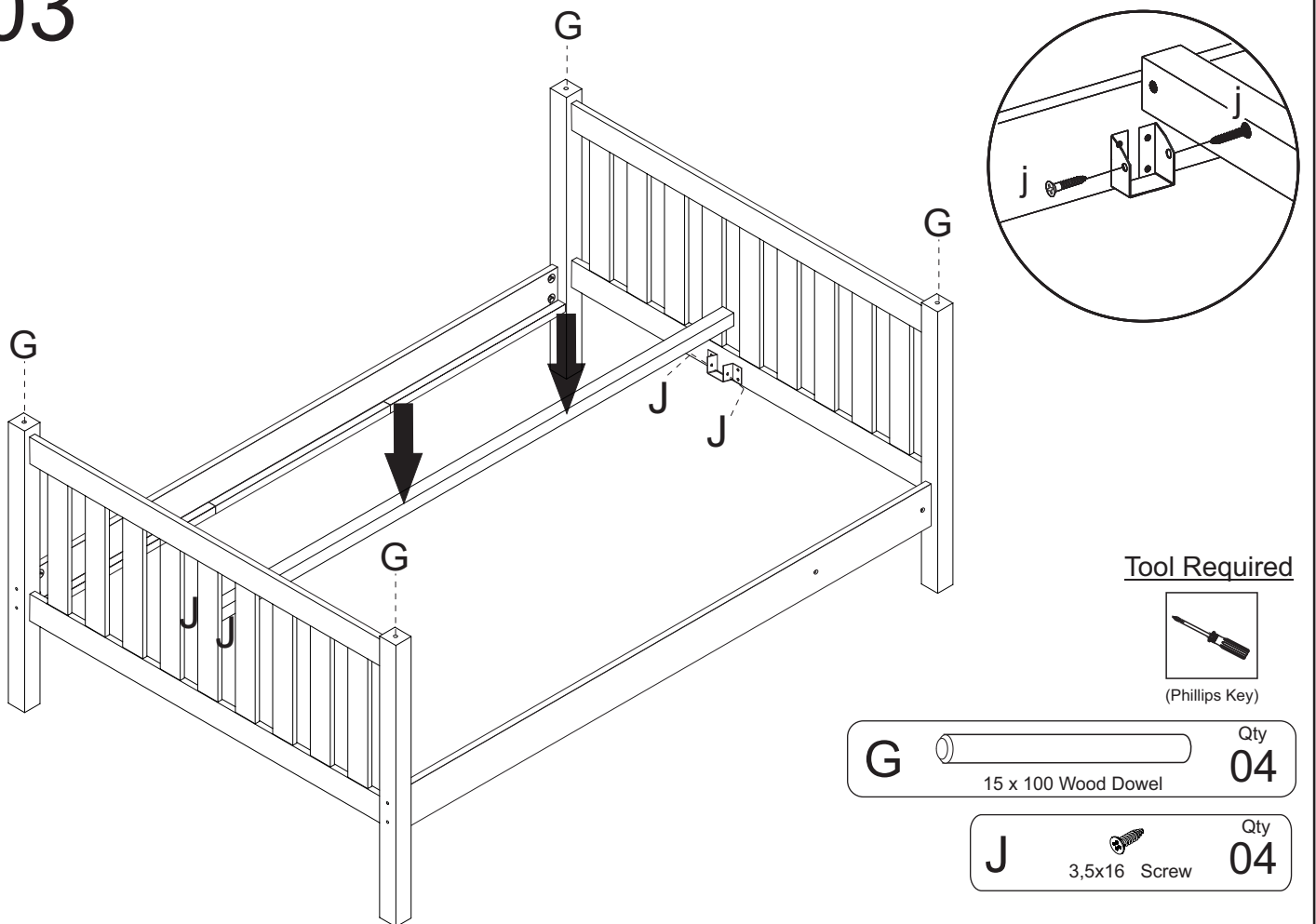

04

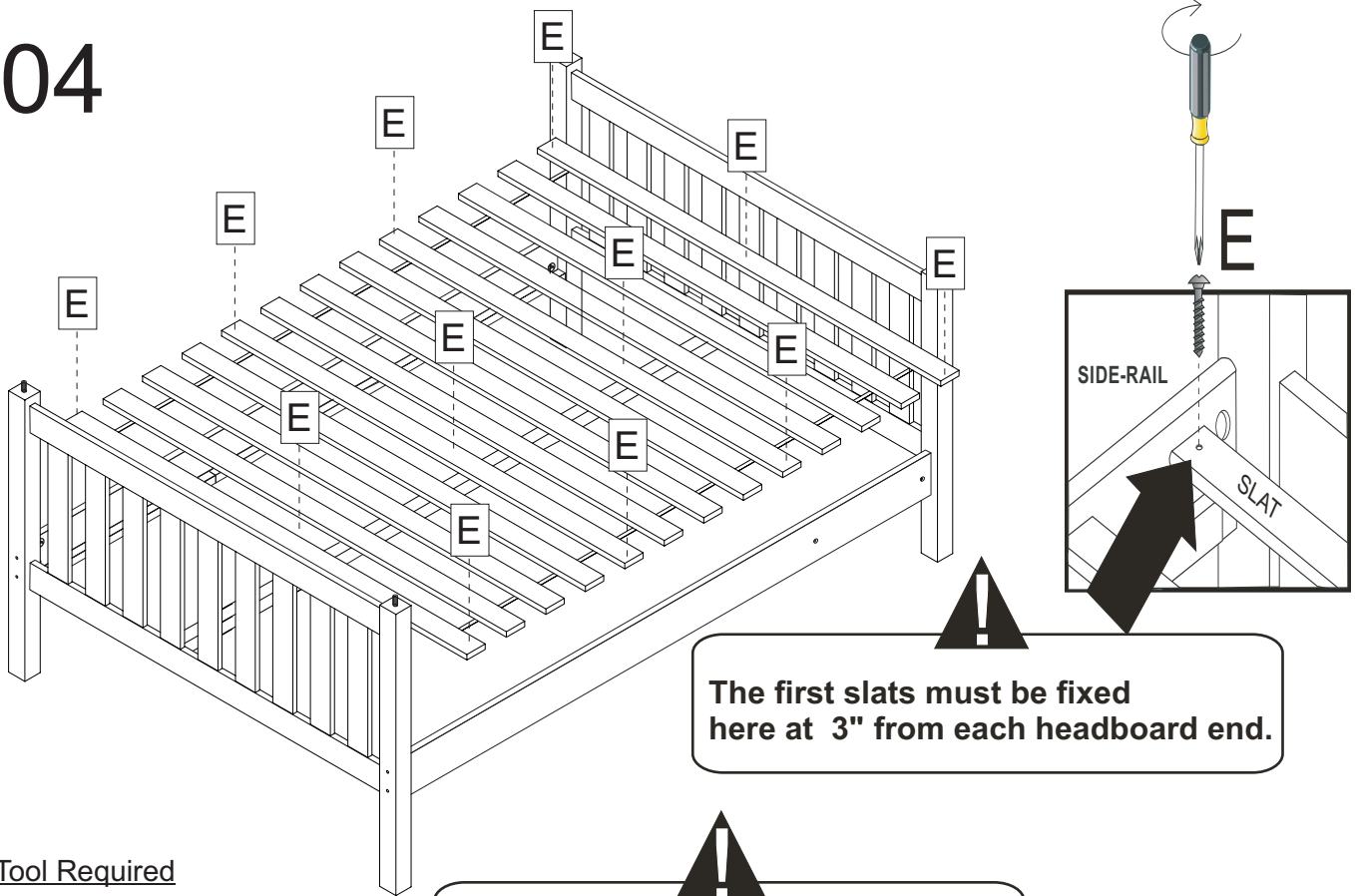

The first slats must be fixed here at 3" from each headboard end.

Tool Required



(Phillips Key)

“INSTALL SLAT KIT WITH SPACER TAPE ON TOP (FACING UP)”

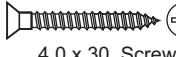
E  Qty **12**
4,0 x 30 Screw

05 TOP BED

Tool Required



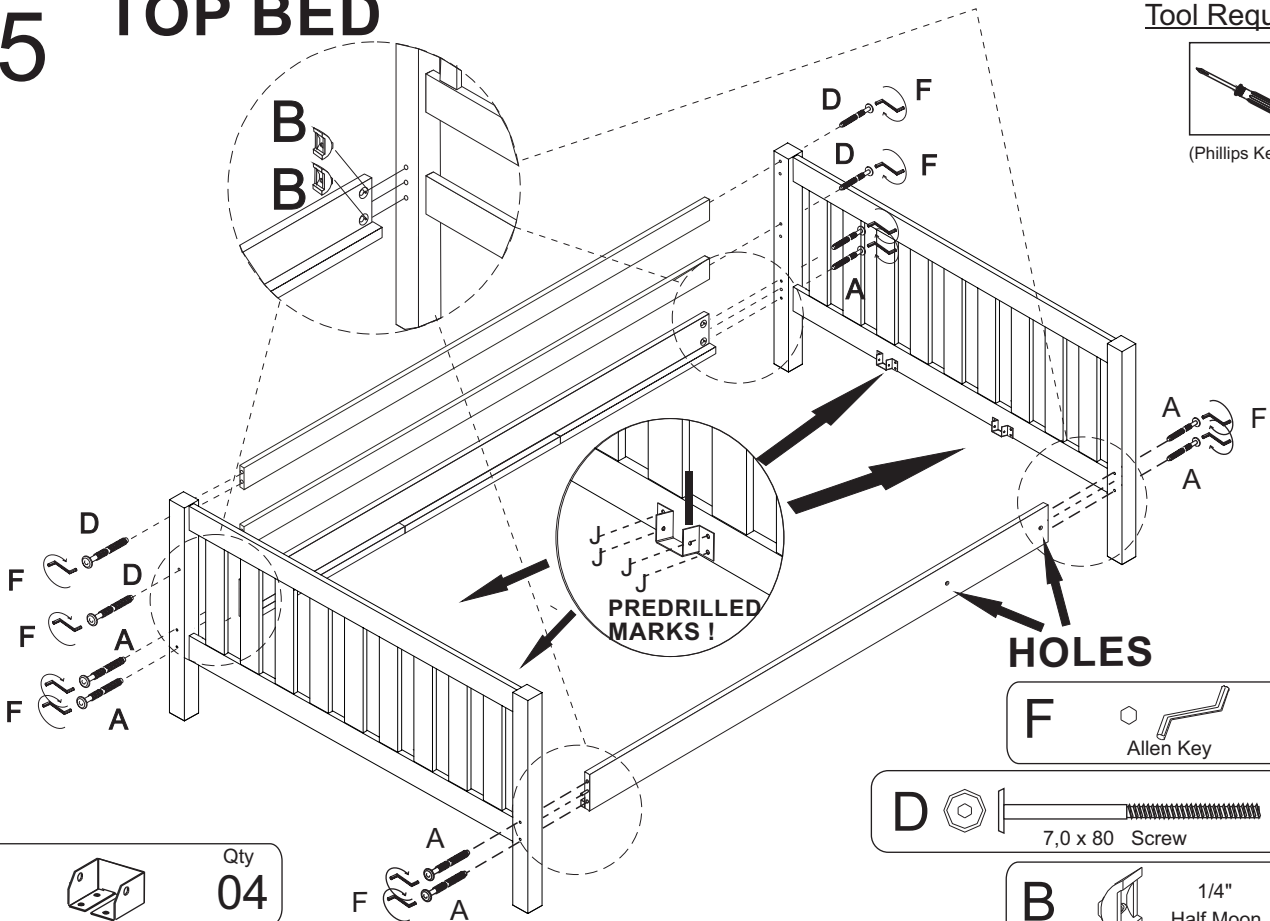

(Phillips Key)



I  Qty **04**

J  Qty **16**
3,5x16 Screw

F  Qty **01**
Allen Key

D  Qty **04**
7,0 x 80 Screw

B  Qty **08**
1/4" Half Moon

A  Qty **08**
1/4 x 80 Screw

06

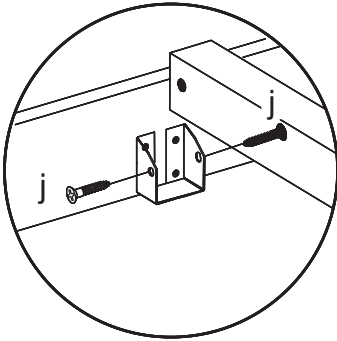
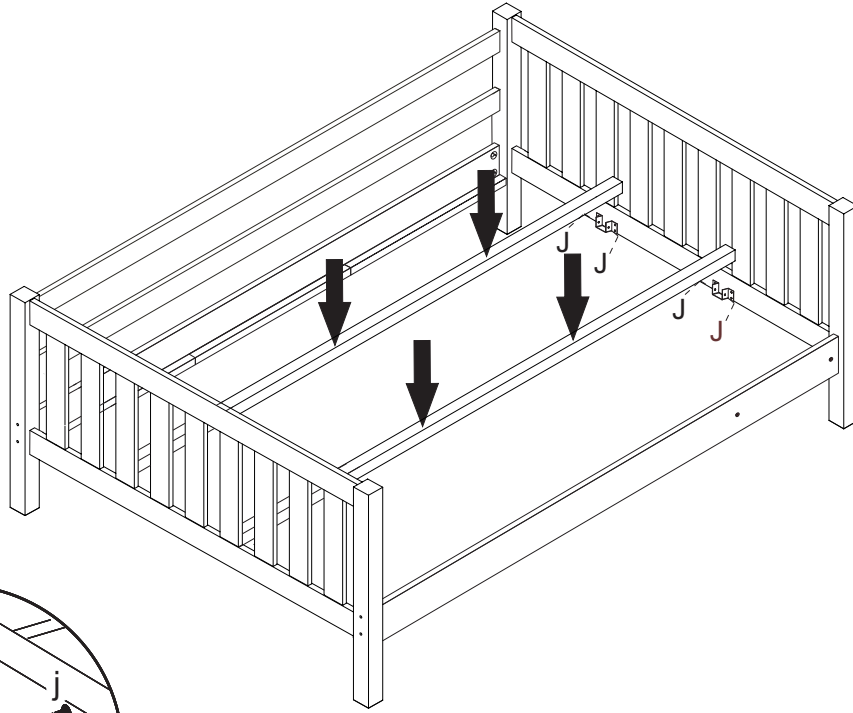

Tool Required



(Phillips Key)

J

3,5x16 Screw

Qty
08

07

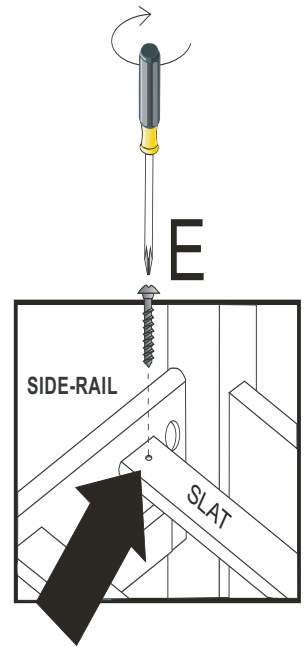
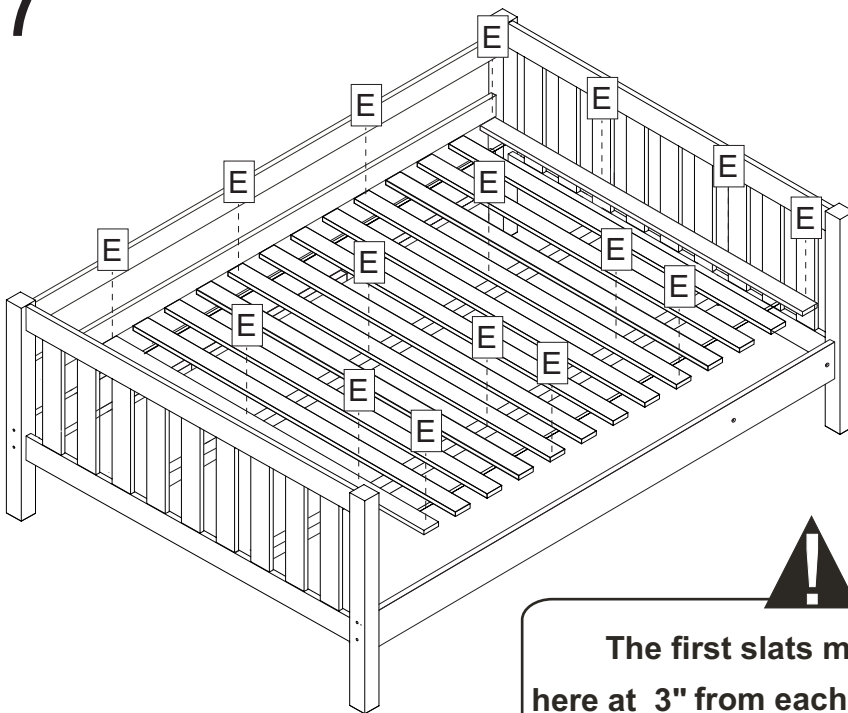

Tool Required



(Phillips Key)

E

4,0 x 30 Screw

Qty
16

INSTALL SLAT KIT WITH SPACER TAPE ON TOP (FACING UP)

08

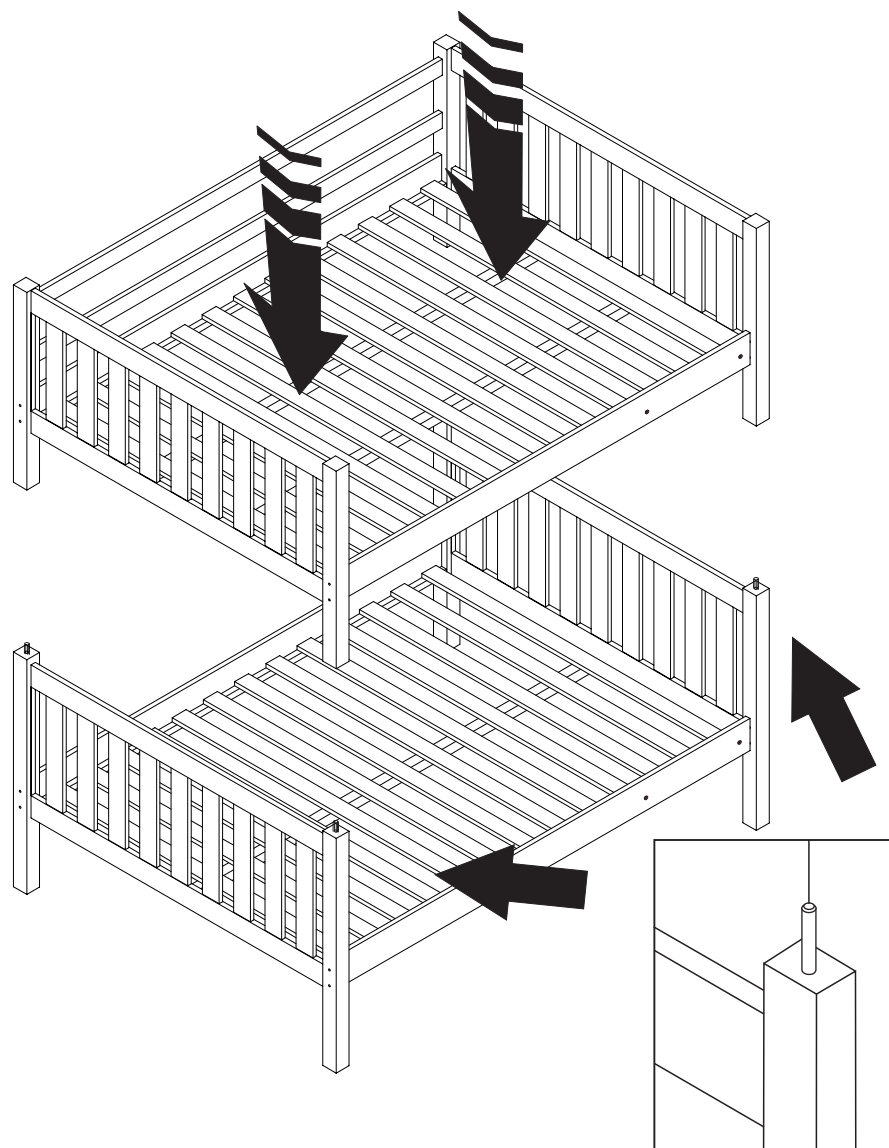

09

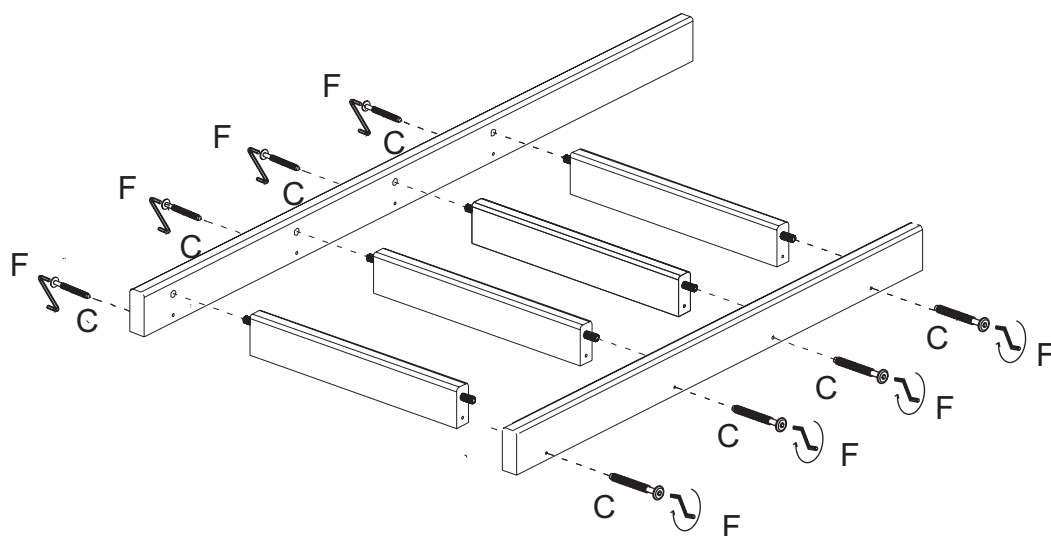

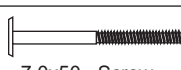

F  Qty **01**
Allen Key

C  Qty **08**
7,0x50 Screw

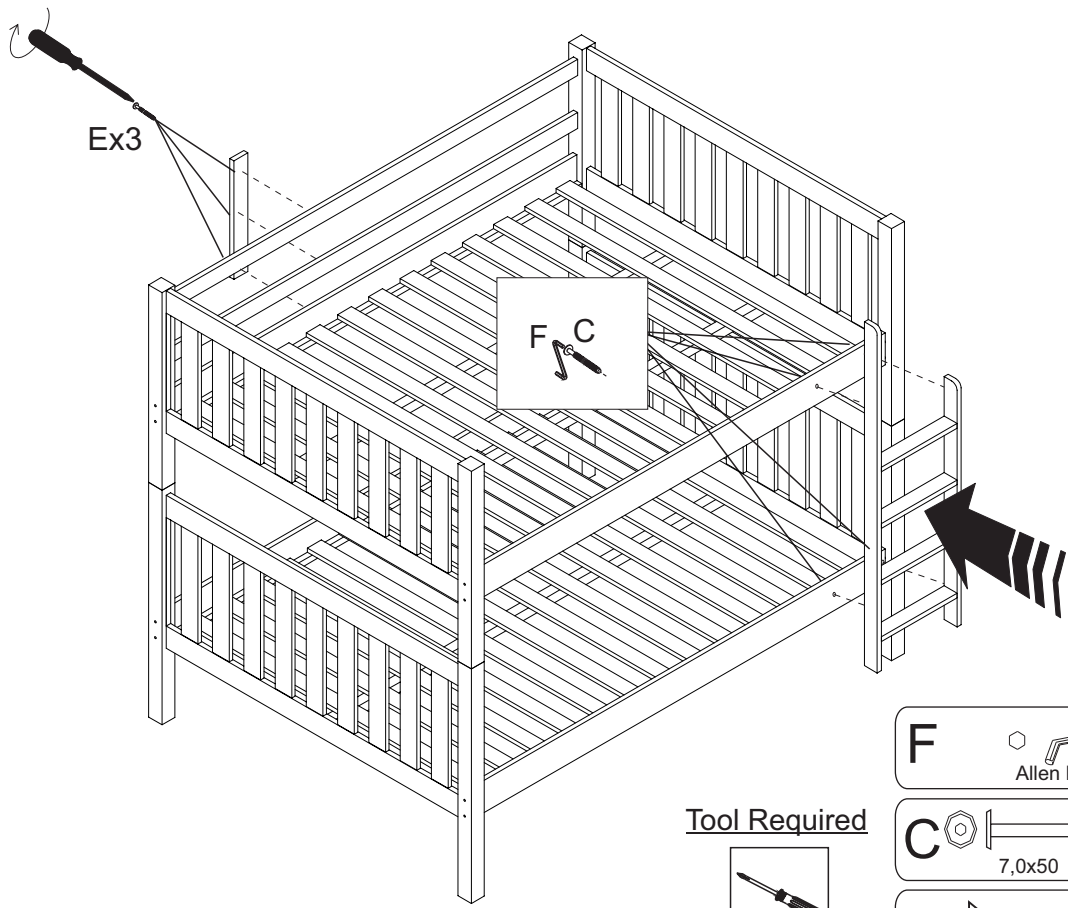
10



F		Qty
	Allen Key	01

C		Qty
	7,0x50 Screw	04

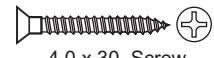
E		Qty
	4,0 x 30 Screw	03

Tool Required



(Phillips Key)

11

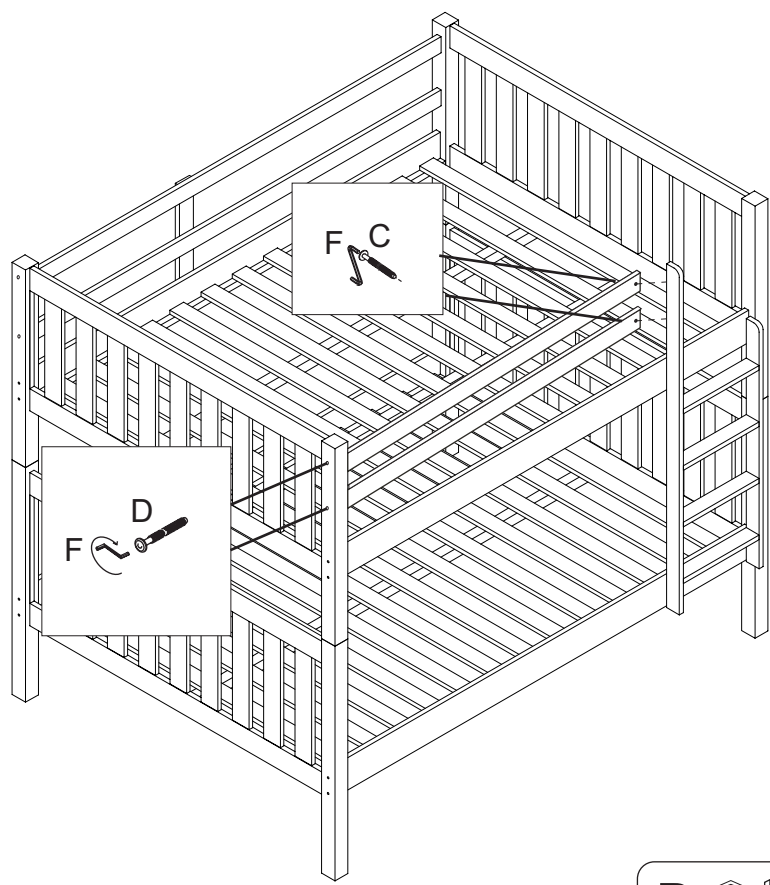

C		Qty
	7,0x50 Screw	02

F		Qty
	Allen Key	01

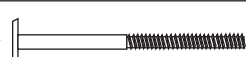
D		Qty
	7,0x80 Screw	02

12

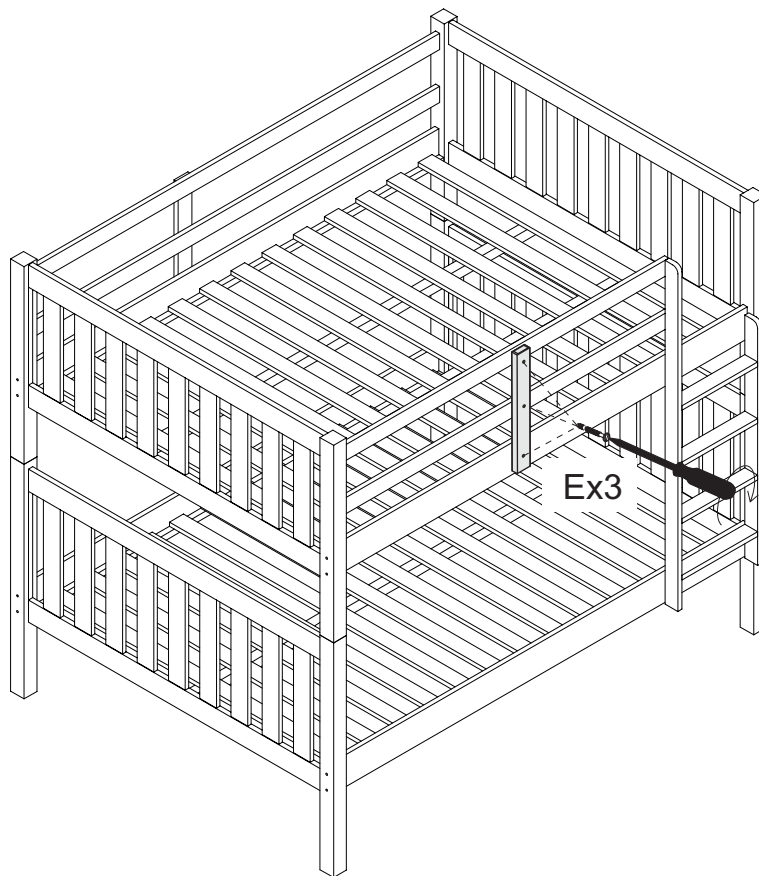

Tool Required



(Phillips Key)

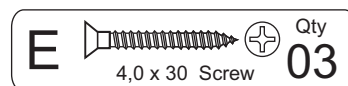

13

