

ATH-M20xBT

Wireless Headphones
ワイヤレスヘッドホン

Quick Start Guide クイックスタートガイド

Support

For more information on how to use this product and troubleshoot any problems, refer to the user manual on the Audio-Technica website.
<https://www.audio-technica.com>



サポート

本製品の詳しい使いかたの確認、接続できない、充電できないなど困ったときの解決方法については、当社ホームページ掲載の取扱説明書やよくあるご質問 (FAQ) をご確認ください。
<https://www.audio-technica.co.jp/support/>



Check / はじめに確認

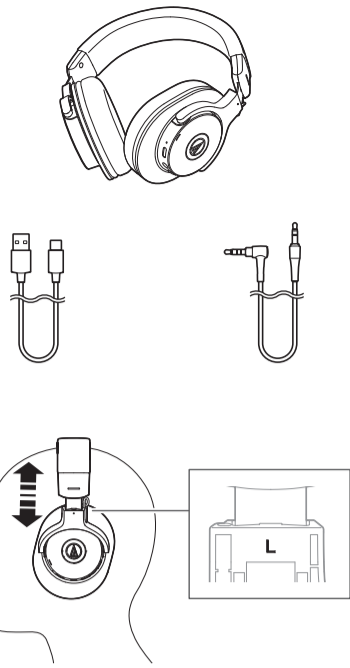

Charging / 充電する

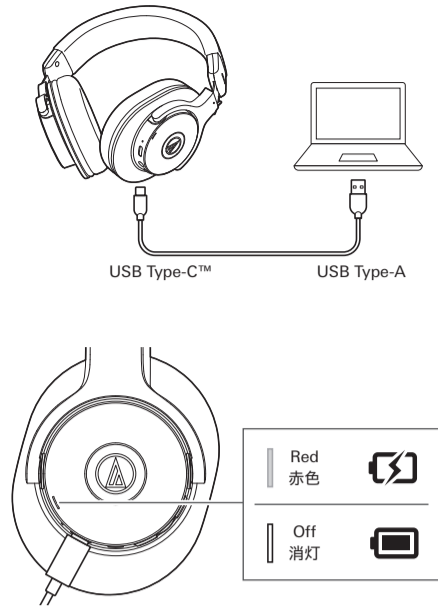

Pairing / ペアリングする

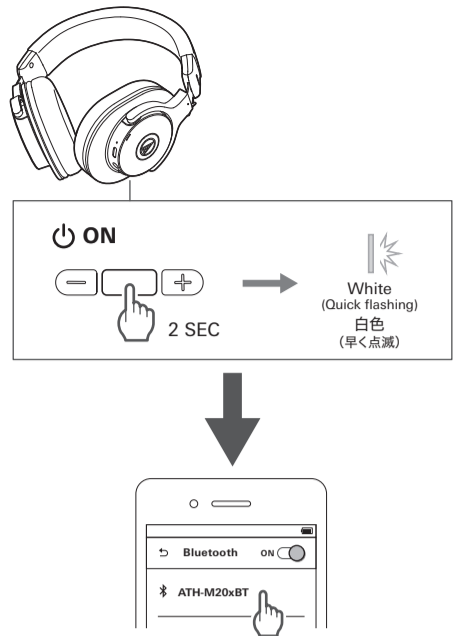

Fast Pair



In one touch, the ATH-M20xBT enables quick, effortless Bluetooth pairing with your Android devices. You can even check to see where you last placed it. Turn on the Bluetooth function on any Android device signed into your Google account, and turn on the headphones and bring them close to the device. A pairing notification will be displayed.

ATH-M20xBTはAndroidデバイスとワンタッチで素早く簡単にペアリング設定できます。最後に置いた場所の確認もできます。Googleアカウント設定済みのAndroidデバイスでBluetooth機能をONにしたあと、ヘッドホンの電源をONにしてデバイスに近づけると通知が表示されます。

Power ON/OFF / 電源 ON/OFF

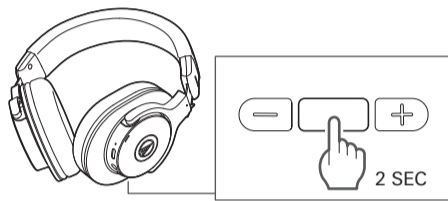

Music / 聴く

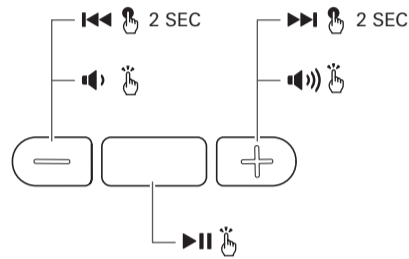

Low latency mode / 低遅延モード

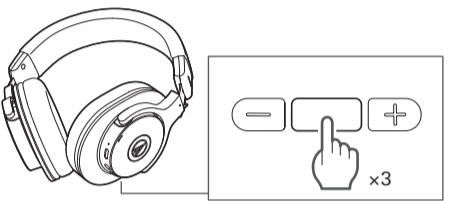

When you play games or watch videos, you can play them with less delay. (Bluetooth communication may be easily interrupted due to obstacles or radio wave conditions. Turn this mode off in such cases.) ゲームや動画視聴をする際に、音の遅延の少ない再生ができます。(障害物や電波状況により、Bluetooth通信が途切れやすくなる場合があります。その場合は、本モードをOFFにしてください。)

- The **Bluetooth®** word mark and logos are registered trademarks owned by Bluetooth SIG, Inc., and any use of such marks by Audio-Technica Corporation is under license.
- Other trademarks and trade names are those of their respective owners.
- USB Type-C™ is a trademark of USB Implementers Forum.
- Siri is trademark of Apple Inc., registered in the U.S. and other countries.
- Google and Android are trademarks of Google LLC.

Siri/Google Assistant

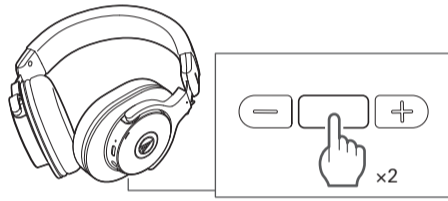

Phone / 通話

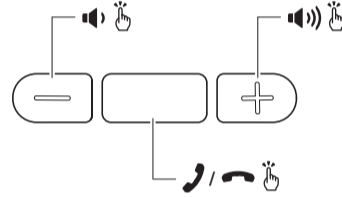

Français / Deutsch / Italiano

Casque sans fil
Kabellose Kopfhörer
Cuffie wireless

Guide de démarrage rapide Kurzanleitung Guida rapida

Support

Pour plus d'informations sur l'utilisation de ce produit et la résolution de problèmes, reportez-vous au manuel de l'utilisateur sur le site Web d'Audio-Technica.

Unterstützung

Weitere Informationen zum Gebrauch dieses Produkts und zur Behebung eventueller Probleme entnehmen Sie bitte der Bedienungsanleitung auf der Website von Audio-Technica.

Assistenza

Per maggiori informazioni sull'utilizzo del presente prodotto e per la risoluzione di eventuali problemi, fare riferimento al manuale dell'utente sul sito Audio-Technica.

<https://www.audio-technica.com>



Contrôle / Kontrolle / Controllo

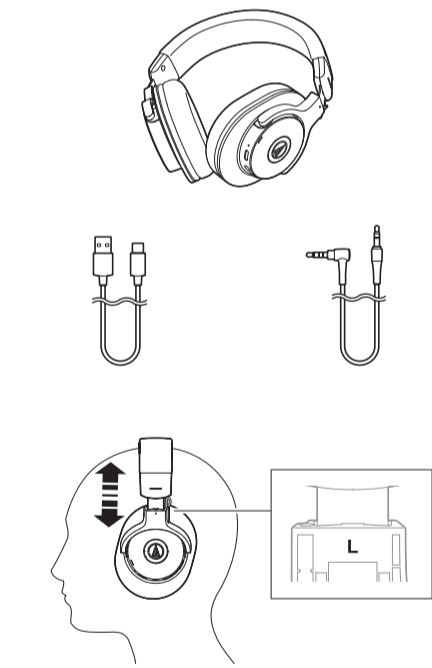

Charge / Laden / Carica

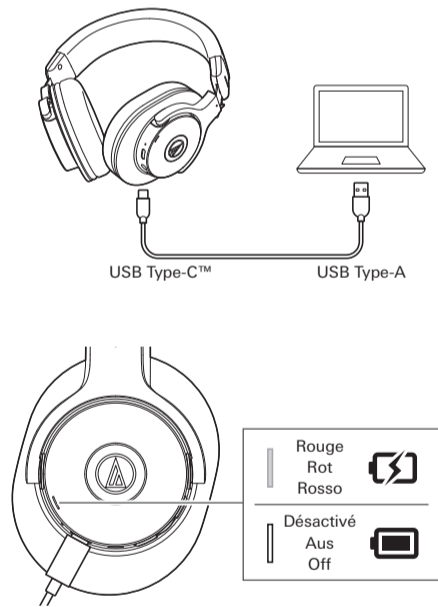

Appairage / Paarung / Associazione

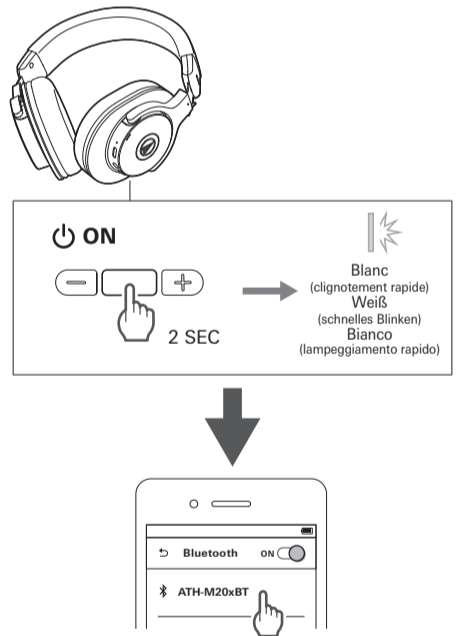

Fast Pair



D'une seule touche, l'ATH-M20xBT permet un appairage Bluetooth rapide et sans effort avec vos appareils Android. Vous pouvez même vérifier où vous l'avez laissé la dernière fois. Activez la fonction Bluetooth sur tout appareil Android connecté à votre compte Google, puis allumez le casque et rapprochez-le de l'appareil. Une notification d'appairage s'affichera.

Die ATH-M20xBT-Kopfhörer ermöglichen eine schnelle, mühelose Bluetooth-Paarung mit Ihren Android-Geräten mit nur einer Berührung. Sie können sogar überprüfen, an welchem Ort Sie das Gerät zuletzt abgelegt haben. Aktivieren Sie die Bluetooth-Funktion auf einem beliebigen Android-Gerät, das auf Ihrem Google-Konto angemeldet ist, schalten Sie anschließend die Kopfhörer ein und bringen Sie sie in die Nähe des Geräts. Es wird eine Paarungsbenachrichtigung angezeigt.

Con un solo tocco, l'ATH-M20xBT consente l'associazione Bluetooth pratico e veloce con i dispositivi Android. È possibile controllare anche dove è stato lasciato il dispositivo l'ultima volta. Attivare la funzione Bluetooth su qualsiasi dispositivo Android connesso al proprio account Google, accendere le cuffie e avvicinarle al dispositivo. Comparirà una notifica di associazione.

Mise sous tension/hors tension / Stromversorgung EIN/AUS / Accensione/spengimento

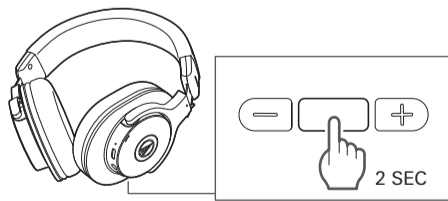

Musique / Musik / Musica

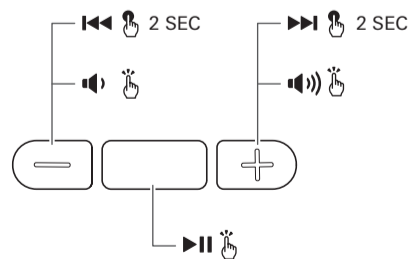

Mode latence faible / Modus mit geringer Latenz / Modalità a bassa latenza

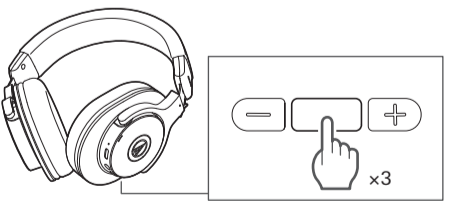

Lorsque vous jouez à des jeux ou regardez des vidéos, vous pouvez le faire avec moins de latence. (La communication Bluetooth peut s'interrompre facilement à cause des obstacles ou en présence d'ondes radio. Arrêtez ce mode le cas échéant.)

Wenn Sie Spiele spielen oder Videos ansehen, nutzen Sie diesen Modus um diese mit weniger Verzögerung abzuspielen. (Die Bluetooth-Kommunikation kann in diesem Modus, aufgrund von Hindernissen oder Funkwellen, leichter unterbrochen werden. Schalten Sie diesen Modus in solchen Fällen aus.)

Quando si gioca o si guardano video, il ritardo è minore. (La comunicazione Bluetooth può essere facilmente interrotta dalla presenza di ostacoli o onde radio. In questi casi disattivare questa modalità.)

Siri/Google Assistant

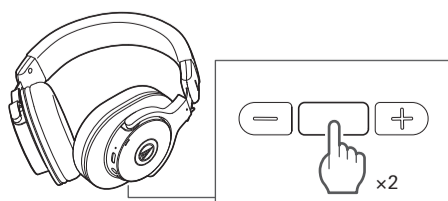

Téléphone / Telefon / Telefono

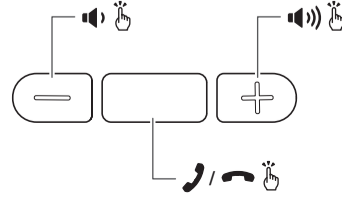

Auriculares inalámbricos
Fones de ouvido sem fio
Беспроводные наушники

Guía de inicio rápido
Guia de início rápido
Краткое руководство по установке

Asistencia

Para más información sobre el uso de este producto y la resolución de problemas, consulte el manual de usuario en el sitio web de Audio-Technica.

Suporte

Para obter mais informações sobre como usar este produto e solucionar qualquer problema, consulte o manual do usuário no site da Audio-Technica.

Техническая поддержка

Для получения дополнительной информации о том, как использовать этот продукт и устранять любые неисправности, обратитесь к руководству пользователя на веб-сайте Audio-Technica.

<https://www.audio-technica.com>

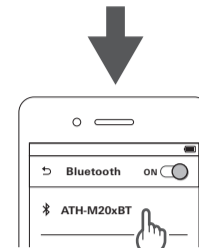
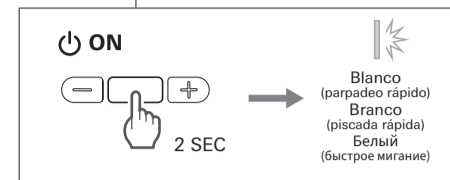
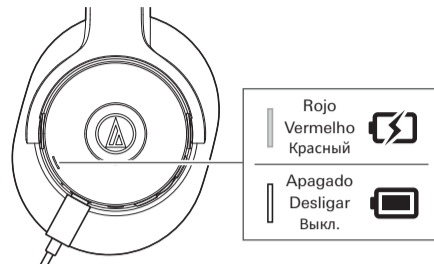
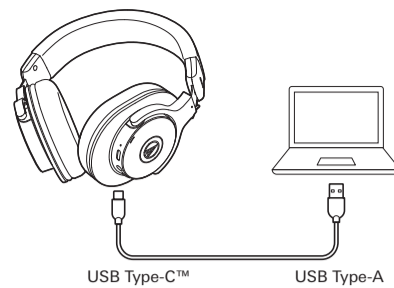
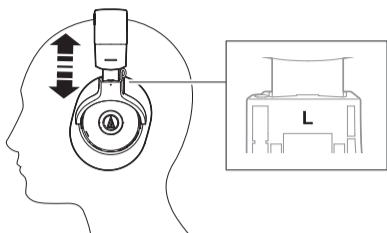
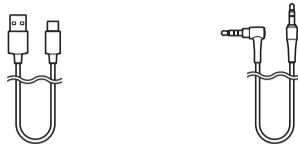

Fast Pair



Con una sola pulsación, el ATH-M20xBT permite el emparejamiento rápido y sin esfuerzo del Bluetooth con sus dispositivos Android. Incluso puede comprobar dónde lo colocó por última vez. Active la función Bluetooth en cualquier dispositivo Android que haya iniciado sesión en su cuenta de Google, encienda los auriculares y acérquelos al dispositivo. Se mostrará una notificación de emparejamiento.

Em um só toque, o ATH-M20xBT permite o emparelhamento rápido e sem esforço do Bluetooth com os seus dispositivos Android. Você pode até mesmo verificar onde o colocou pela última vez. Ative a função Bluetooth em qualquer dispositivo Android conectado à sua conta do Google, ligue os fones de ouvido e os traga para perto do dispositivo. Será exibida uma notificação de emparelhamento.

ATH-M20xBT обеспечивает быстрое и беспрблемное сопряжение с вашим устройством Android через Bluetooth. Вы даже сможете найти его. Включите Bluetooth на любом устройстве Android, зарегистрированном в вашем аккаунте Google, включите наушники и поднесите их близко к устройству. Появится сообщение о сопряжении.

Encendido y apagado / Ligado/Desligado / Включение/выключение питания

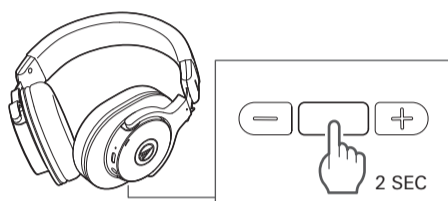

Música / Música / Музыка

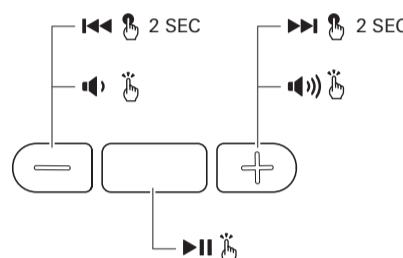

Modo de baja latencia / Modo de baixa latência / Режим низкой задержки

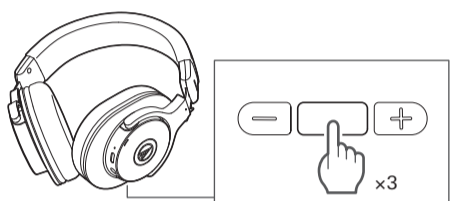

Al jugar o ver videos, se puede jugar con menos retraso. (A comunicação por Bluetooth puede interrumpirse fácilmente debido a obstáculos o propagación de ondas de radio. Desactive este modo en estos casos.)

Quando você joga ou assiste a vídeos, pode fazê-lo com menos atraso. (A comunicação por Bluetooth pode ser facilmente interrompida devido a obstáculos ou condições de ondas de rádio. Desative este modo nesses casos.)

Вы можете уменьшить время задержки во время игр или просмотра видео. (Связь через Bluetooth может быть легко прервана препятствиями или радиоволнами. В таких случаях отключите этот режим.)

Siri/Google Assistant

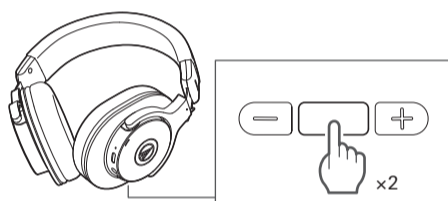

Teléfono / Telefone / Телефон

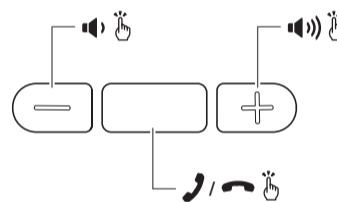

头戴式无线耳机
無線耳機
무선 헤드폰

快速启动指南
快速入門指南
간편 사용 설명서

支持信息

关于如何使用本产品及解决各种问题的详细信息, 请参阅“铁三角”网站上的用户手册。

支援資訊

有關本產品的使用方法以及各種問題的故障排除方法, 請參閱「鐵三角」網站上的使用說明書。

지원

본 제품의 사용법 및 문제 해결에 관한 자세한 사항은 Audio-Technica 웹사이트의 사용자 설명서를 참조하십시오.

<https://www.audio-technica.com>

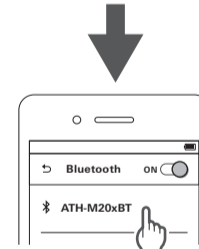
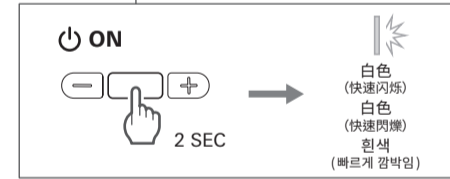
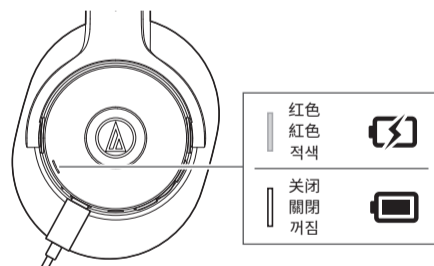
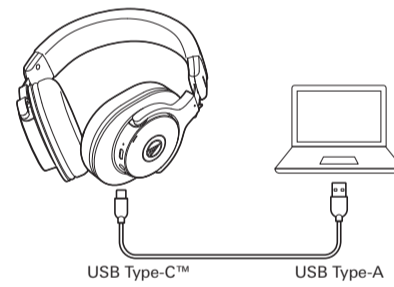
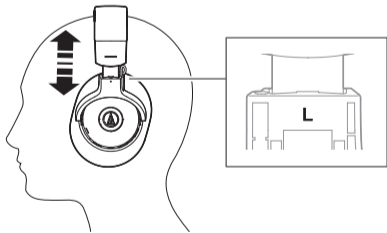
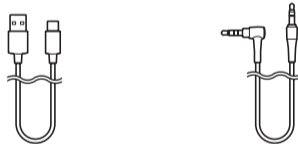

Fast Pair



只需轻轻一触, ATH-M20xBT 即可迅速轻松地与您的 Android 设备进行蓝牙配对。您也可以找寻最后将它放在何处。在登录 Google 帐户的任何 Android 设备上开启蓝牙功能, 然后将耳机开机并靠近设备。这样会显示配对通知。

只需輕觸一次, ATH-M20xBT 即可與您的 Android 裝置進行快速、輕鬆的藍牙配對。您也可以查看耳機最後放置的位置。在任何登入 Google 帳戶的 Android 裝置開啟藍牙功能, 然後開啟耳機並將其靠近該裝置。此時會顯示配對通知。

ATH-M20xBT 는 한 번의 터치로 Android 장치와 빠르고 쉽게 페어링 할 수 있습니다. 마지막으로 놓아둔 장소까지 확인 가능합니다. 사용자 Google 계정에 로그인되어 있는 Android 장치의 Bluetooth 기능을 켜 다음, 헤드폰을 켜 장치 근처로 가져옵니다. 페어링 알림이 화면에 나타납니다.

电源 ON / OFF / 電源開啟 / 關閉 / 전원 ON/OFF

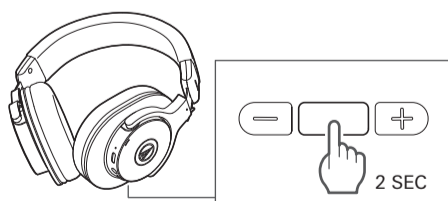

音乐 / 音樂 / 음악

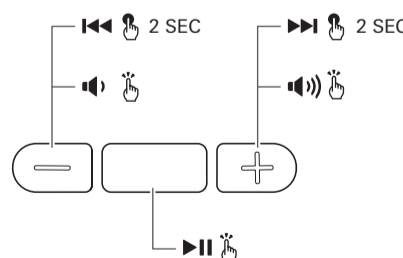

低延迟模式 / 低延遲模式 / 저지연 모드

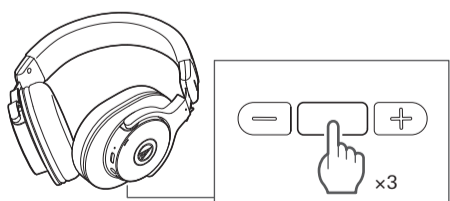

当您玩游戏或观看视频时, 可以减少延迟。(由于障碍物或无线电波影响, 蓝牙通信可能容易中断。在这种情况下, 请关闭此模式。)

玩遊戲或觀看影片時, 可以減少延遲。(如因障礙物與無線電波的影響, 導致藍牙通訊容易中斷時, 請將此模式關閉。)

게임을 하거나 비디오를 볼 때 지연을 줄일 수 있습니다. (장애물이나 무선 전파로 인해 Bluetooth 통신이 쉽게 중단될 수 있습니다. 이러한 경우 이 모드를 종료해 주십시오.)

Siri/Google Assistant

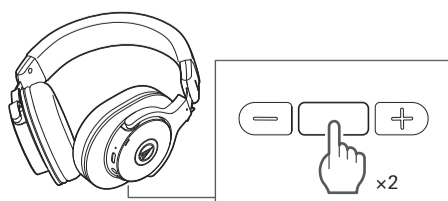

电话 / 電話 / 전화

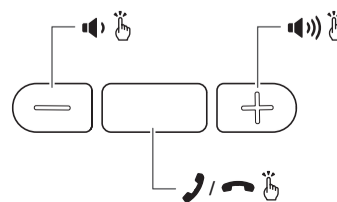

株式会社オーディオテクニカ
〒194-8666 東京都町田市西成瀬2-46-1
www.audio-technica.co.jp
Audio-Technica Corporation
2-46-1 Nishi-naruse, Machida, Tokyo 194-8666, Japan
Global Support Contact: www.at-globalsupport.com
©2021 Audio-Technica Corporation
132513440-01-01