

ELICA PRO SERIES CERVINIA

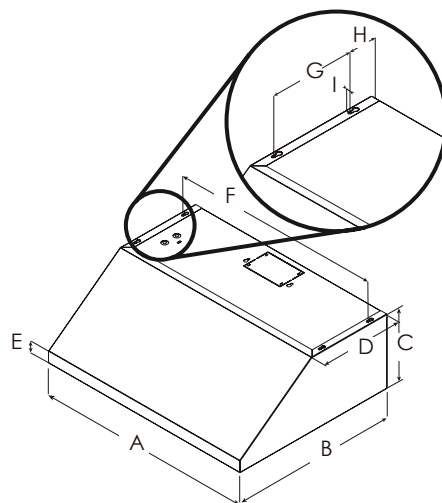

ELICA'S EXCLUSIVE PLUS FEATURES

Available in 30" and 36" widths and only 10" high, the Cervinia is a streamlined version of the full-size Calabria model. This hood features professional styling, seamless welded corner craftsmanship, a powerful 600 CFM blower with high airflow, heavy duty stainless steel baffle grease filters, Replaceable LED lighting, plus backlit hidden metallic in/out knobs for convenience and safety. Cervinia also delivers higher efficiency and easy maintenance for a cleaner kitchen.



	ECV630S3	ECV636S3
A	30" (76 cm)	36" (91.54 cm)
B	23" (58.4 cm)	
C	11 1/32" (27.9 cm)	
D	11 1/16" (29.7 cm)	
E	2 19/32" (6.6 cm)	
F	29" (73.3 cm)	35" (88.9 cm)
G	7 1/2" (19 cm)	
H	2 9/16" (6.5 cm)	
I	3/8" (1 cm)	



MOUNTING HEIGHT RANGE

≥ 24" ≥ 30"

ELICA PRO SERIES CERVINIA









SPECIFICATIONS

	30" Unit	36" Unit
Model: Dimensions: Blower Type(internal): Blower Performance: Speed 1 Speed 2 Speed 3 Speed 4 Noise (sones): Working Speed Finish: Controls: Illumination: (replaceable lamps 1 intensity) Filter Type: Angled Baffle Filters: Duct Transition: Installation Type: Electrical:	ECV630S3 30"W x 23"D x 11 1/32"H 600 CFM (4 -speed) 170 CFM 280 CFM 440 CFM 600 CFM Min: 2.34, Max: 7 Stainless Steel Fully retractable rotating knobs with blue backlighting 2 LED, 7.5 W 2 Dishwasher-Safe, 2 Professional Stainless Steel, Angled Baffle Filter z Rectangular 3" 1/4 x 10" (top and rear) Ducted Installation Only 120V - 60 Hz	ECV636S3 36"W x 23"D x 11 1/32"H 600 CFM (4 -speed) 170 CFM 280 CFM 440 CFM 600 CFM Min: 2.34, Max: 7 Stainless Steel Fully retractable rotating knobs with blue backlighting 2 LED, 7.5 W 2 Dishwasher-Safe, 2 Professional Stainless Steel, Angled Baffle Filter z Rectangular 3" 1/4 x 10" (top and rear) Ducted Installation Only 120V - 60 Hz
KITS: Long Chimney Extension Kit 6": Long Chimney Extension Kit 12": Back Splash Kit:	KIT2159 KIT2160 KIT0142864	KIT2158 KIT2161 KIT0142867
CONSUMABLE PARTS: Replacement Grease Filter (1): Replacement Light Bulb (1):	GF044A LMP0131098	GF03ZA LMP0131098

*Consumable parts are sold in units of one (1). Order accordingly

PLUS FEATURES

- 
HUSH SYSTEM - An exclusive sound deadening technology that effectively reduces sound levels by over 35%
- 
LED CONSUMER REPLACEABLE BULB - High quality LED lighting usually requires a skilled technician to replace lamps. Avoid this expense with Elica's new LED lamps that enable homeowners to replace in seconds
- 
SEAMLESS CRAFTSMANSHIP - Heavy gauge stainless steel "Seamless" construction that delivers refined elegance.
- 
STAINLESS STEEL BAFFLE FILTERS WITH GREASE COLLECTORS - Designed for high airflow cooking, the "S" shape design traps high volumes of grease
- 
PROFESSIONAL PERFORMANCE - Special features and high performances for models with aspiration capacity between 600 and 1200 CFM's
- 
HEAT GUARD - Senses extreme temperatures (>158 degrees) and automatically adjusts the blower speed to HIGH