

# SAMSUNG

## Product Guide

# Bespoke 28 cu. ft. Side-by-side Refrigerator with Beverage Center™

RS28CB7600

Available in:

Bespoke White Glass

Fingerprint Resistant Stainless Steel



# Table of Contents

## Product Overview

Product Overview	4
Carousel Image Order	5

## Product Messaging

Features and Benefits	8
Lifestyle Images	13
Videos	14

## Product Specs

Spec Sheet	16
<i>Will It Fit?</i> Guide	17
Energy Guide and User Manual	18
Warranty	19

## Feature Icons

21

# Product Overview

---

**RS28CB7600 – Bespoke Side-by-side 28 cu. ft. Refrigerator  
with Beverage Center™**

# Product Overview

## Product Title

Bespoke Side-by-Side Refrigerator 28 cu. ft. with Beverage Center™ & Dual Ice Maker

## Product Description (Paragraph)

Add style to your kitchen with the Bespoke side-by-side white glass or stainless steel refrigerator. The Beverage Center includes a dispenser and AutoFill Water Pitcher with the option to infuse with a flavor. The Dual Auto Ice Maker lets you choose from cubed ice or Ice Bites™ that chill your drink faster.\* The Auto Open Door makes it even easier to open the door\*\*, with a light touch over the sensor.

\*Compared to cubed ice.

\*\*The door automatically opens about 25 mm.

## Product Description (Bullets)

- Add style to your kitchen with the Bespoke side-by-side white glass or stainless steel refrigerator.
- Convenient access to refreshingly cool, filtered water is always in reach.
- The Beverage Center™ includes a dispenser and AutoFill Water Pitcher with the option to infuse with a flavor.
- Choose from cubed ice or Ice Bites™ that chill your drink faster.\*
- The Auto Open Door makes it even easier to open the door\*\*, with a light touch over the sensor.”

\*Compared to cubed ice.

\*\*The door automatically opens about 25 mm.

## Easy Ads Links

**White Glass:** <https://dam.gettyimages.com/p/z0c3461/digital-appliances?o=AND&q=RS28CB760012>

**Stainless Steel:** <https://dam.gettyimages.com/p/z0c3461/digital-appliances?o=AND&q=RS28CB7600QL>

## Available Colors



**Bespoke White Glass**

RS28CB760012



**Fingerprint Resistant Stainless Steel**

RS28CB7600QL





# RS28CB760012 Carousel Image Order

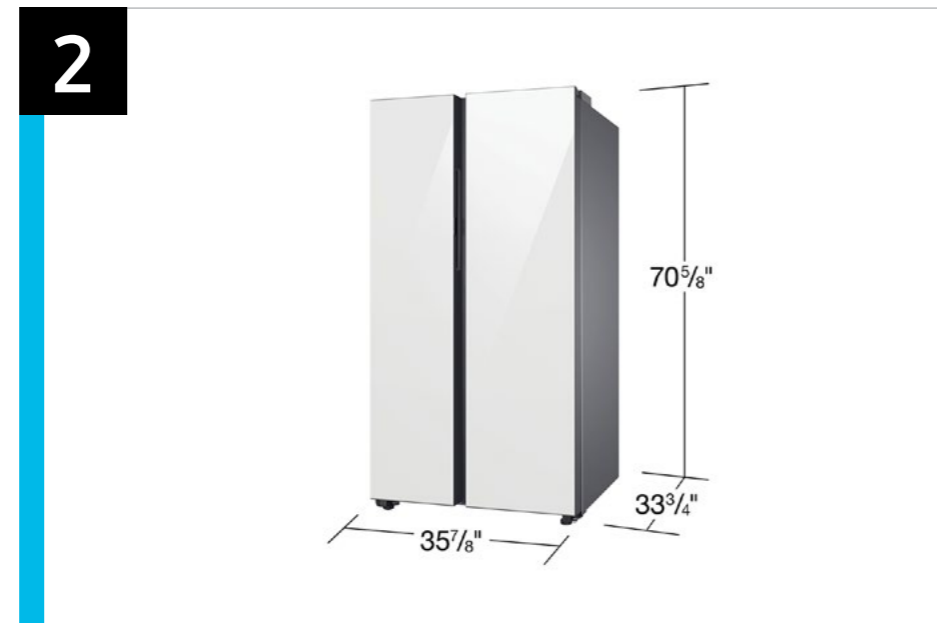



# RS28CB7600QL Carousel Image Order





# Product Messaging



---

RS28CB7600 – Bespoke Side-by-side 28 cu. ft. Refrigerator  
with Beverage Center™





Features and Benefits – RS28CB7600				
Overall Product Headline	Feature Name	Long Body Copy	Short Body Copy	Associated Image
<b>Designed for you</b>	<b>Bespoke Design</b>	Create a stylish kitchen with your choice of color and finish: Bespoke White Glass or fingerprint-resistant Stainless Steel.	Add style to your kitchen with your choice of finish.	
<b>Water two ways</b>	<b>Beverage Center™</b>	Convenient access to refreshingly cool, filtered water is always in reach. The Beverage Center™ includes a dispenser and AutoFill Water Pitcher with the option to infuse with a flavor.	Refreshing cold water is always within reach.	
<b>Ice your way</b>	<b>Dual Auto Ice Maker</b>	Choose from cubed ice or Ice Bites™ that chill your drink faster.* <small>*Compared to cubed ice</small>	Get ice two ways, cubed or Ice Bites.™	

## Features and Benefits – RS28CB7600

Overall Product Headline	Feature Name	Long Body Copy	Short Body Copy	Associated Image
<p><b>Open doors effortlessly</b></p>	<p><b>Auto Open Door</b></p>	<p>Auto Open Door makes it even easier to open the door, with just a light touch.*                      *Door automatically opens about 25 mm.</p>	<p>Open doors with a light touch.</p>	
<p><b>Store more inside</b></p>	<p><b>Extra Large Capacity</b></p>	<p>Store more in the extra spacious 28 cu. ft. interior* with SpaceMax™ technology, for the best use of your kitchen space.                      *Free standing model capacity is 28 cu. ft.; counter-depth model capacity is 23 cu. ft.</p>	<p>More storage with SpaceMax™ technology.</p>	
<p><b>A spacious and stylish interior</b></p>	<p><b>Premium Interior Design</b></p>	<p>The adjustable slide-in shelves are flexibly designed to be able to fit in just half of the fridge, so you can slide them back to create more room for tall and bulky items. A silver accent on the edge of the shelves adds a premium look throughout the interior.</p>	<p>Adjustable slide-in shelves store it all, short and tall, and silver-accented shelves add a premium look to the interior.</p>	



## Features and Benefits – RS28CB7600 (Continued)

Overall Product Headline	Feature Name	Long Body Copy	Short Body Copy	Associated Image
<p><b>Energy management at your fingertips</b></p>	<p><b>SmartThings Energy</b></p>	<p>SmartThings Energy* lets you easily check that your power consumption is within preset targets, so that you can adjust if needed.</p> <p><small>*Available on Android and iOS devices. A Wi-Fi connection and a Samsung account are required.</small></p>	<p>SmartThings Energy* monitors and helps you optimize your energy consumption to save money.</p> <p><small>*Available on Android and iOS devices. A Wi-Fi connection and a Samsung account are required.</small></p>	
<p><b>Even cooling from corner to corner</b></p>	<p><b>All-Around Cooling</b></p>	<p>Keep items at the same temperature throughout the interior, so that everything stays fresher, longer. All-Around Cooling uses evenly spaced vents and continual temperature monitoring to ensure consistent cooling from corner to corner.</p>	<p>Cools evenly from corner to corner, so food stays fresher, longer.</p>	
<p><b>Easy-to-reach controls for everyone</b></p>	<p><b>ADA-Compliant Display</b></p>	<p>Enjoy a stylish and easy way to access the controls. The display enhances the minimalist design as it is discreetly hidden inside. It is also compliant with the standards of the Americans with Disabilities Act (ADA), as the controls are all within arm's reach and can be used with just one hand.</p>	<p>Provides seamlessly stylish easy access to controls, even if you have restricted movement.</p>	

## Features and Benefits – RS28CB7600 (Continued)

Overall Product Headline	Feature Name	Long Body Copy	Short Body Copy	Associated Image
<p><b>Eco-friendly and energy-efficient</b></p>	<p><b>ENERGY STAR® Certified</b></p>	<p>Save energy and money, while protecting the planet by reducing harmful carbon emissions. This refrigerator is ENERGY STAR® certified for its outstanding energy efficiency. Proven to use less power, without sacrificing performance or functionality.</p>	<p>Save energy and money, while protecting the environment.</p>	

# Lifestyle Images

---

RS28CB7600 – Bespoke Side-by-side 28 cu. ft. Refrigerator  
with Beverage Center™



# Lifestyle Images



Bespoke White Glass



Bespoke White Glass – For Kitchen Promotion Use Only



Bespoke White Glass Alternate



Stainless Steel



Stainless Steel



# Videos



Bespoke Side-by-Side Refrigerator (Full Video)

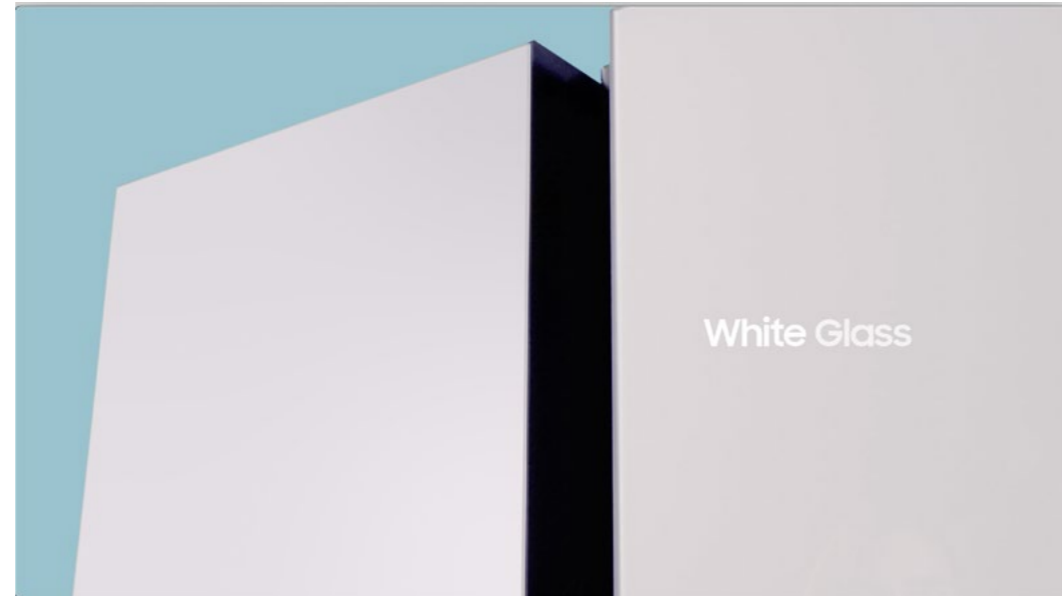

Bespoke Design

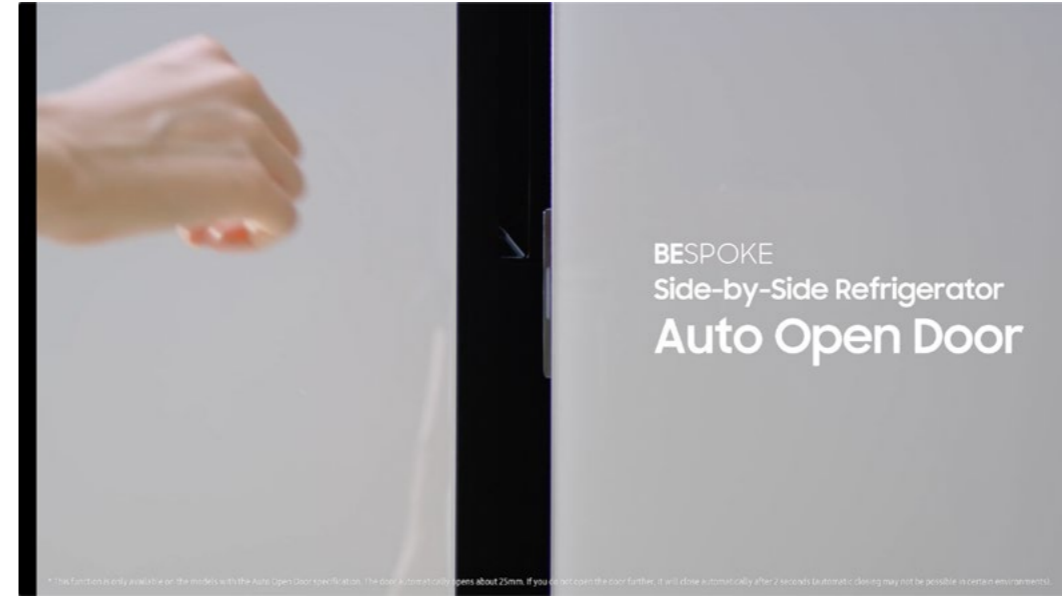

Auto Open Door



Beverage Center™



AutoFill Water Pitcher



Dual Auto Ice Maker



Space Max™ Technology



All-Around Cooling

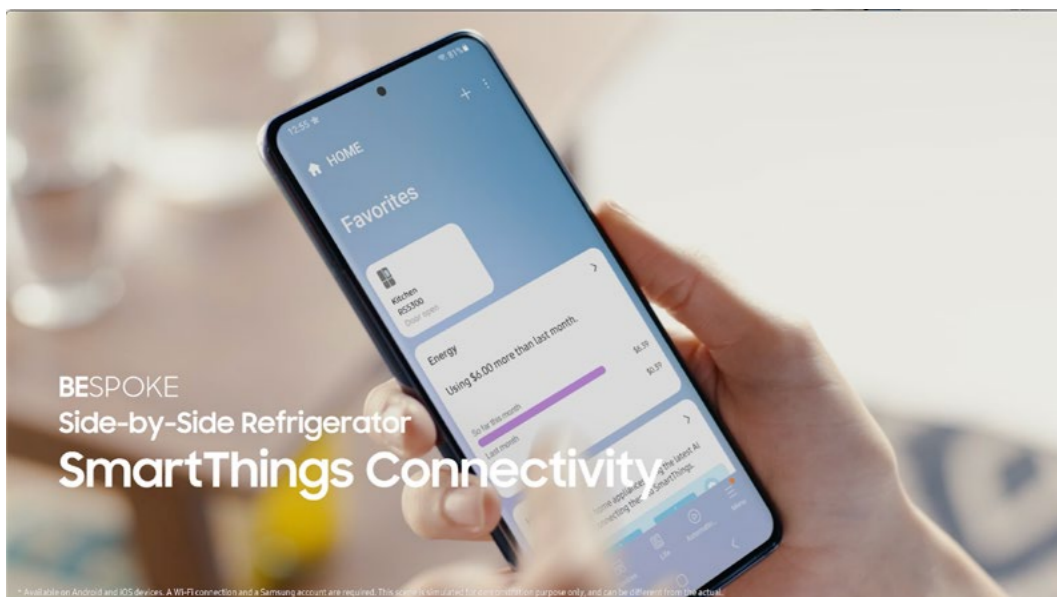

SmartThings Connectivity

# Product Specs

---

**RS28CB7600 – Bespoke Side-by-side 28 cu. ft. Refrigerator  
with Beverage Center™**



# Spec Sheet

## RS28CB760012

Bespoke 28 cu. ft. Smart Side-by-Side Refrigerator with Beverage Center™

SAMSUNG



### Signature Features

**Bespoke Design**  
Create a stylish kitchen with your choice of finishes: White Glass or fingerprint resistant Stainless Steel. Crafted from quality materials to blend seamlessly with your space.

**Beverage Center™**  
Convenient access to refreshingly cool, filtered water is always in reach. The Beverage Center™ includes a dispenser and AutoFill Water Pitcher—with the option to infuse with a flavor.

**Dual Auto Ice Maker**  
Choose from cubed ice or Ice Bites™ that chill your drink faster.

**Power Touch Sensor**  
The Power Touch Sensor allows you to open the doors effortlessly. Simply place your hand over the sensors and the door will softly nudge open automatically.  
\*The door automatically opens about 25 mm. If you do not open the door further, it will close automatically after 2 seconds. Automatic closing may not be possible in certain environments.



Bespoke Design



Beverage Center™

**Available Colors**

- White Glass (shown)
- Fingerprint Resistant Stainless Steel

**Design**

- Bespoke Design
- Beverage Center™
- Slide-In Shelf
- Silver-Accent Shelving
- LED Lighting
- 3 Gallon Door Bins
- Adjustable Top Freezer Shelf

**Technology**

- Wi-Fi Enabled
- Power Touch Sensor
- Power Cool & Power Freeze
- Door Alarm
- Water Filter Indicator
- Sabbath Mode

**Performance**

- Dual Auto Ice Maker with Ice Bites™
- SmartThings Energy\*
- All-Around Cooling

\*Available on Android and iOS devices. Wi-Fi, refrigerator and a Samsung account are required.

**Rating**



ENERGY STAR® rated:  
655 kWh/yr



SmartThings



ADA Compliant

## RS28CB760012

Bespoke 28 cu. ft. Smart Side-by-Side Refrigerator with Beverage Center™

SAMSUNG

### Installation Specifications

1. Measure the height, width and depth of the opening, making sure to include baseboards, molding, tile, countertop overhang, etc. Check to be sure there is enough room to open the door (consider walls, islands or other obstacles when measuring).
2. Refer to illustration below to determine dimensions.
3. Allow 2.5" of clearance on hinge side of refrigerator when installing next to a wall where handle may make contact.
4. Allow 1" minimum clearance at rear for proper air circulation and water/electrical connections. Allow a 3/8" minimum clearance at sides and top for ease of installation.
5. Ensure each door and entryway in the home is wide enough for the refrigerator to be moved through easily.

For optimal usage and ability to open refrigerator doors completely, do not install next to a wall.  
Please note: The following dimension and cutout information is for planning purposes only. For complete installation details, consult manual packed with product or download manual online at [samsung.com](http://samsung.com).

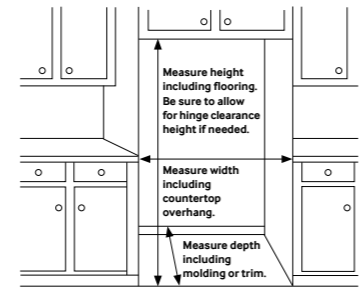

### Dimensions

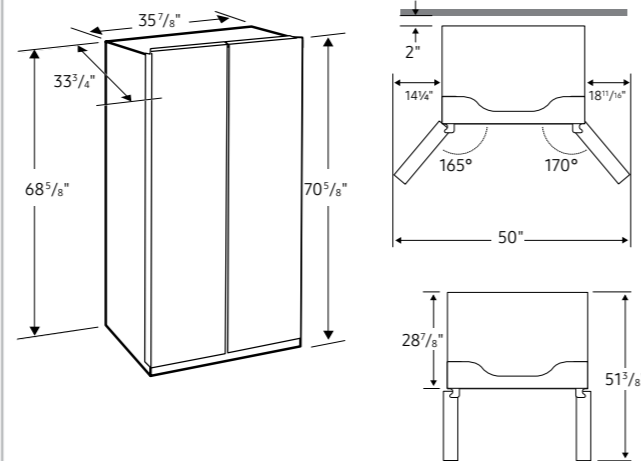

**Total Capacity: 28.0 cu. ft.**

**Refrigerator: 17.9 cu. ft.**

- 4 Tempered Glass Shelves
- Slide-In Shelf
- 2 Drawers
- 5 Door Bins
  - 3 Gallon Bins
  - 2 Door Bins
- Top LED Lighting

**Freezer: 10.1 cu. ft.**

- Dual Ice Maker in Freezer (Cubed Ice AND Ice Bites)
- Adjustable Top Freezer Shelf
- 4 Tempered Glass Shelves
- 2 Drawers
- 5 Door Bins
- Top LED Lighting

**Accessories**

Water Filter: HAF-QIN

**Warranty**

One (1) Year Parts and Labor on Refrigerator  
Five (5) Years Parts and Labor on Sealed Refrigeration System Only\*  
Ten (10) Years Parts and Five (5) Years Labor on Digital Inverter Compressor  
\*Compressor, evaporator, condenser, drier and connecting tubing.

**Product Dimensions & Weight**

Dimensions (WxHxD with hinges, recessed handles, and doors): 35 7/8" x 70 3/4" x 33 1/4"

Dimensions (WxHxD without hinges and door): 35 1/8" x 68 3/8" x 28 7/8"

Weight: 263 lbs

**Shipping Dimensions & Weight (WxHxD)**

Dimensions: 37 1/4" x 75 1/8" x 35"

Weight: 271 lbs

Color	Model #	UPC Code
White Glass	RS28CB760012	887276715902
Fingerprint Resistant Stainless Steel	RS28CB7600QL	887276715919

Actual color may vary. Design, specifications, and color availability are subject to change without notice. Non-metric weights and measurements are approximate.  
©2023 Samsung Electronics America, Inc., 85 Challenger Road, Ridgefield Park, NJ 07660. Tel: 800-SAMSUNG. [samsung.com](http://samsung.com). Samsung is a registered trademark of Samsung Electronics Co., Ltd.

Spec Sheet - front

Spec Sheet - back

# Will It Fit? Guide

28 cu. ft. Side-by-Side
SAMSUNG

MODEL RS28CB7600 DIMENSIONS

**Be sure your new fridge will fit**  
 Don't wait until delivery to be sure your new refrigerator will fit – both in your kitchen and through all doorways. This guide includes all pertinent measurements and clearances so you can buy with confidence.

**Standard-Depth Refrigerator**  
 Standard-depth refrigerators typically measure 30 to 35 inches in depth, as opposed to counter-depth refrigerators that sit flush with cabinetry.

**Installation clearances**

- ✓ Allow 3.75" of clearance when installing along a wall. This will allow for the door to open 90 degrees without contacting the wall.
- ✓ Allow 2" minimum clearance at rear for proper air circulation and water/electrical connections.
- ✓ Allow a 3/8" minimum clearance at sides and top for ease of installation.

**For optimal usage and ability to open refrigerator doors completely, do not install next to a wall.**

Please note: The above dimensions and cutout information is for planning purposes only. For complete installation details, consult manual packed with product, or download manual online at [samsung.com](http://samsung.com).

**Walk the delivery route**

- ✓ Identify the narrowest opening that the appliance will travel, from outside the home to the location where it will be installed.
- ✓ Appliance depth or width must be smaller than the width of the narrowest opening.

Will It Fit? Guide

# Energy Guide and User Manual

U.S. Government Federal law prohibits removal of this label before consumer purchase.

# ENERGYGUIDE

Refrigerator-Freezer

- Automatic Defrost
- Side-Mounted Freezer
- No Through-the-Door Ice

Samsung  
Model RS28CB7600\*\*  
Capacity: 28.0 Cubic Feet

Compare **ONLY** to other labels with yellow numbers.  
Labels with yellow numbers are based on the same test procedures.

Estimated Yearly Energy Cost  
**\$92**

Models with similar features	\$91	\$113
All models	\$67	\$122

**656 kWh**  
Estimated Yearly Electricity Use

- Your cost will depend on your utility rates and use.
- Both cost ranges based on models of similar size capacity.
- Models with similar features have automatic defrost, side-mounted freezer, and no through-the-door ice.
- Estimated energy cost based on a national average electricity cost of 14 cents per kWh.

ftc.gov/energy



Energy Guide

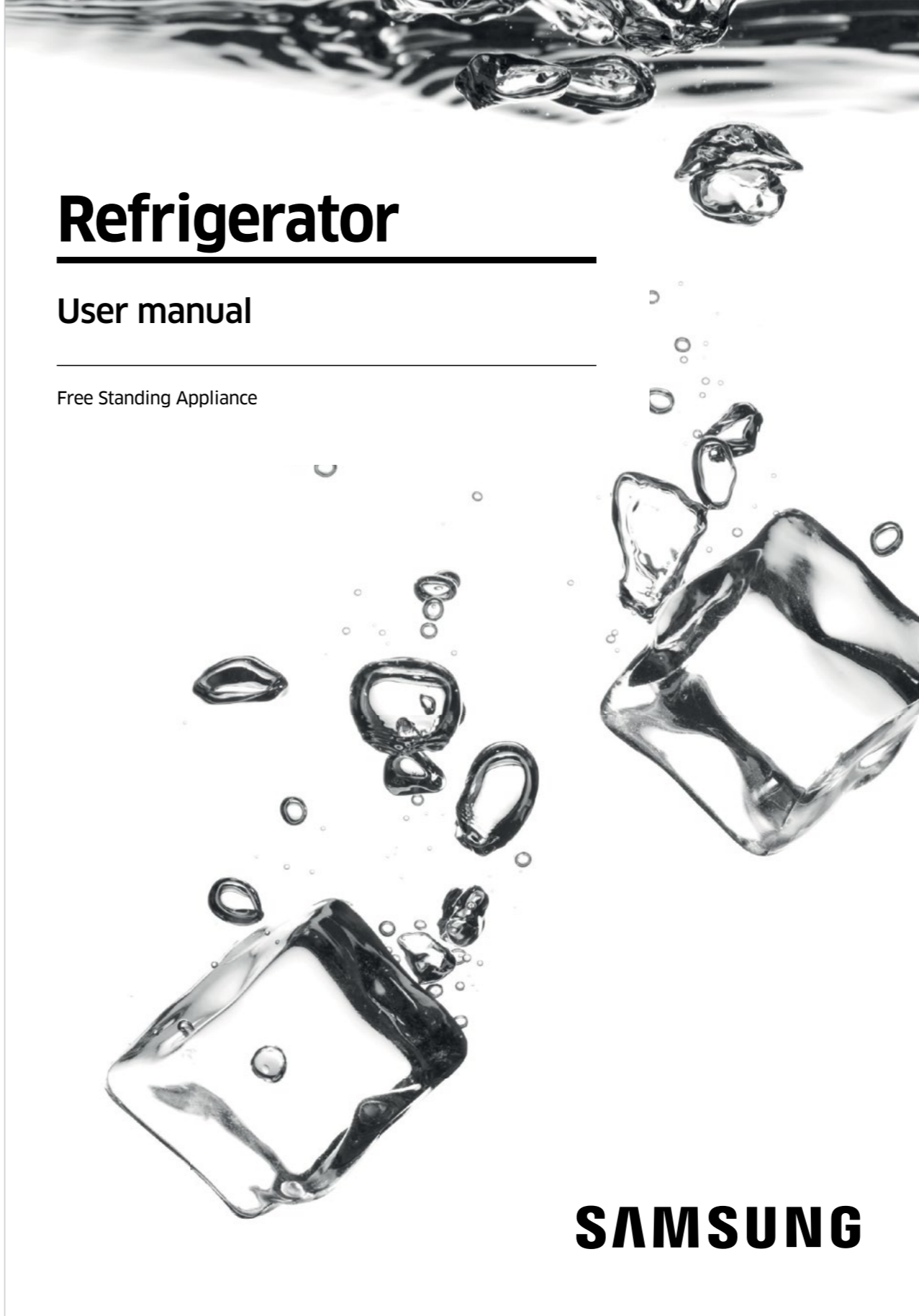

# Refrigerator

## User manual

Free Standing Appliance

**SAMSUNG**

User Manual

# Warranty

## LIMITED WARRANTY (U.S.A.) – SAMSUNG REFRIGERATOR

### Models:

RS28CB760012  
RS28CB7600QL

### LIMITED WARRANTY TO ORIGINAL PURCHASER WITH PROOF OF PURCHASE

This SAMSUNG brand product, as supplied and distributed by Samsung Electronics America, Inc. (SAMSUNG) and delivered new, in the original carton to the original consumer purchaser, is warranted by SAMSUNG against manufacturing defects in materials or workmanship for the limited warranty period of:

#### One (1) year parts and labor

#### Five (5) years parts and labor on Sealed Refrigeration System Only

#### (Compressor, Evaporator, Condenser, Drier, and Connecting Tubing)

#### Ten (10) years part and Five (5) years labor on Digital Inverter Compressor Only

This limited warranty is valid only on products purchased and used in the United States that have been installed, operated, and maintained according to the instructions attached to or furnished with the product. To receive warranty service, the purchaser must contact SAMSUNG at the address or phone number provided below for problem determination and service procedures. Warranty service can only be performed by a SAMSUNG authorized service center. The original dated bill of sale must be presented upon request as proof of purchase to SAMSUNG or SAMSUNG's authorized service center to receive warranty service.

SAMSUNG will provide in-home service within the contiguous United States during the warranty period at no charge, subject to availability of SAMSUNG authorized servicers within the customer's geographic area. If in-home service is not available, SAMSUNG may elect, at its option, to provide transportation of the product to and from an authorized service center. If the product is located in an area where service by a SAMSUNG authorized servicer is not available, you may be responsible for a trip charge or required to bring the product to a SAMSUNG authorized service center for service.

To receive in-home service, product must be unobstructed and accessible to the service agent.

During the applicable warranty period, a product will be repaired, replaced, or the purchase price refunded, at the sole option of SAMSUNG. SAMSUNG may use new or reconditioned parts in repairing a product, or replace the product with a new or reconditioned product. Replacement parts and products are warranted for the remaining portion of the original product's warranty or ninety (90) days, whichever is longer. All replaced parts and products are the property of SAMSUNG and you must return them to SAMSUNG.

This limited warranty covers manufacturing defects in materials or workmanship encountered in normal household, noncommercial use of this product and shall not cover the following: damage that occurs in shipment, delivery, installation, and uses for which this product was not intended; damage caused by unauthorized modification or alteration of the product; product where the original factory serial numbers have been removed, defaced, changed in any way, or cannot be readily determined; cosmetic

damage including scratches, dents, chips, and other damage to the product's finishes; damage caused by abuse, misuse, pest infestations, accident, fire, floods, or other acts of nature or God; damage caused by use of equipment, utilities, services, parts, supplies, accessories, applications, installations, repairs, external wiring or connectors not supplied or authorized by SAMSUNG; damage caused by incorrect electrical line current, voltage, fluctuations and surges; damage caused by failure to operate and maintain the product according to instructions; in-home instruction on how to use your product; and service to correct installation not in accordance with electrical or plumbing codes or correction of household electrical or plumbing (i.e., house wiring, fuses, or water inlet hoses). The cost of repair or replacement under these excluded circumstances shall be the customer's responsibility.

Visits by an authorized servicer to explain product functions, maintenance or installation are not covered by this limited warranty. Please contact SAMSUNG at the number below for assistance with any of these issues.

### EXCLUSION OF IMPLIED WARRANTIES

IMPLIED WARRANTIES, INCLUDING THE IMPLIED WARRANTIES OF MERCHANTABILITY OR FITNESS FOR A PARTICULAR PURPOSE, ARE LIMITED TO ONE YEAR OR THE SHORTEST PERIOD ALLOWED BY LAW. Some states do not allow limitations on how long an implied warranty lasts, so the above limitations or exclusions may not apply to you. This warranty gives you specific rights, and you may also have other rights, which vary from state to state.

### LIMITATION OF REMEDIES

YOUR SOLE AND EXCLUSIVE REMEDY IS PRODUCT REPAIR, PRODUCT REPLACEMENT, OR REFUND OF THE PURCHASE PRICE AT SAMSUNG'S OPTION, AS PROVIDED IN THIS LIMITED WARRANTY. SAMSUNG SHALL NOT BE LIABLE FOR SPECIAL, INCIDENTAL OR CONSEQUENTIAL DAMAGES, INCLUDING BUT NOT LIMITED TO TIME AWAY FROM WORK, HOTELS AND/OR RESTAURANT MEALS, REMODELING EXPENSES, LOSS OF REVENUE OR PROFITS, FAILURE TO REALIZE SAVINGS OR OTHER BENEFITS REGARDLESS OF THE LEGAL THEORY ON WHICH THE CLAIM IS BASED, AND EVEN IF SAMSUNG HAS BEEN ADVISED OF THE POSSIBILITY OF SUCH DAMAGES. Some states do not allow exclusion or limitation of incidental or consequential damages, so the above limitations or exclusions may not apply to you. This warranty gives you specific rights, and you may also have other rights, which vary from state to state.

SAMSUNG does not warrant uninterrupted or error-free operation of the product.

No warranty or guarantee given by any other person, firm, or corporation with respect to this product shall be binding on SAMSUNG.

To obtain warranty service, please contact SAMSUNG at:

Samsung Electronics America, Inc.  
85 Challenger Road  
Ridgefield Park, NJ 07660  
1-800-SAMSUNG (726-7864) and [www.samsung.com/us/support](http://www.samsung.com/us/support)



# Feature Icons

---

RS28CB7600 – Bespoke Side-by-side 28 cu. ft. Refrigerator  
with Beverage Center™



# Feature Icons

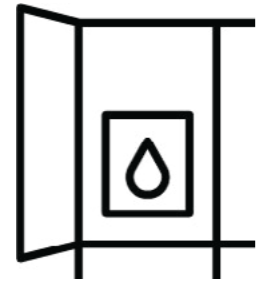

Beverage Center™

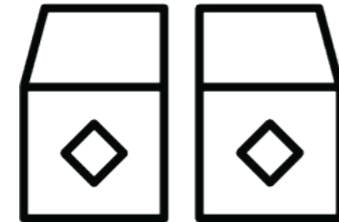

Dual Ice Maker

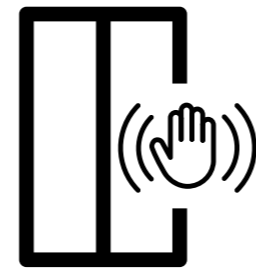

Auto Open Door

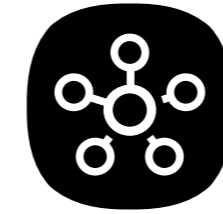

Smart Things

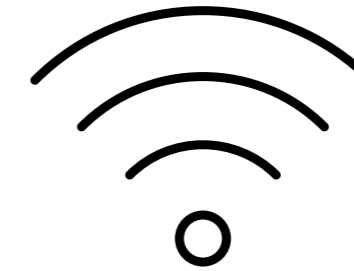

Wi-Fi Connectivity



10-Year Motor Warranty\*

\*10 years of warranty coverage on the compressor.

**SAMSUNG**