

SAMSUNG

Product Guide

1.1 cu. ft. Bespoke Smart SLIM Over-the-Range Microwave with 400 CFM Hood Ventilation, Wi-Fi & Voice Control

ME11CB751012

ME11A7510DS

ME11A7510DG

Available in:

Bespoke White Glass

Stainless Steel

Black Stainless Steel



Table of Contents

1.1 cu. ft. Bespoke Smart SLIM Over-the-Range Microwave with 400 CFM Hood Ventilation, Wi-Fi & Voice Control

Product Overview

Product Overview	4
Carousel Image Order	5

Product Messaging

Features and Benefits	8
Lifestyle Images	13
Product Videos	15

Product Specs

Review Mapping and Related Products	17
Spec Sheet	18
Manuals and Warranty	19

Feature Icons	21
---------------	----

Product Overview

**1.1 cu. ft. Bespoke Smart SLIM Over-the-Range Microwave
with 400 CFM Hood Ventilation, Wi-Fi & Voice Control**

Product Overview

Bespoke White Glass Product Title

1.1 cu. ft. Bespoke Smart SLIM Over-the-Range Microwave with 400 CFM Hood Ventilation, Wi-Fi & Voice Control

Product Description (Paragraph)

Free up space above your cooktop with the new, beautifully designed Smart SLIM Microwave. This combination microwave with hood packs powerful performance and the technology you love into a slim, space-efficient size. Bespoke is Samsung's premium line of home appliances that leads the way in design, technology, and connectivity.

Product Description (Bullets)

- Free up space above your cooktop with the new, beautifully designed Smart SLIM Microwave.
- This combination microwave with ventilation hood fits into the same space as an under-the-cabinet hood, and despite its slim size, has a 1.1 cu. ft. capacity.
- The SLIM Microwave packs the powerful performance you need with all the technology that you love into a slim, space-efficient size.
- Bespoke is Samsung's premium line of home appliances, leading the way in design, technology, and connectivity.

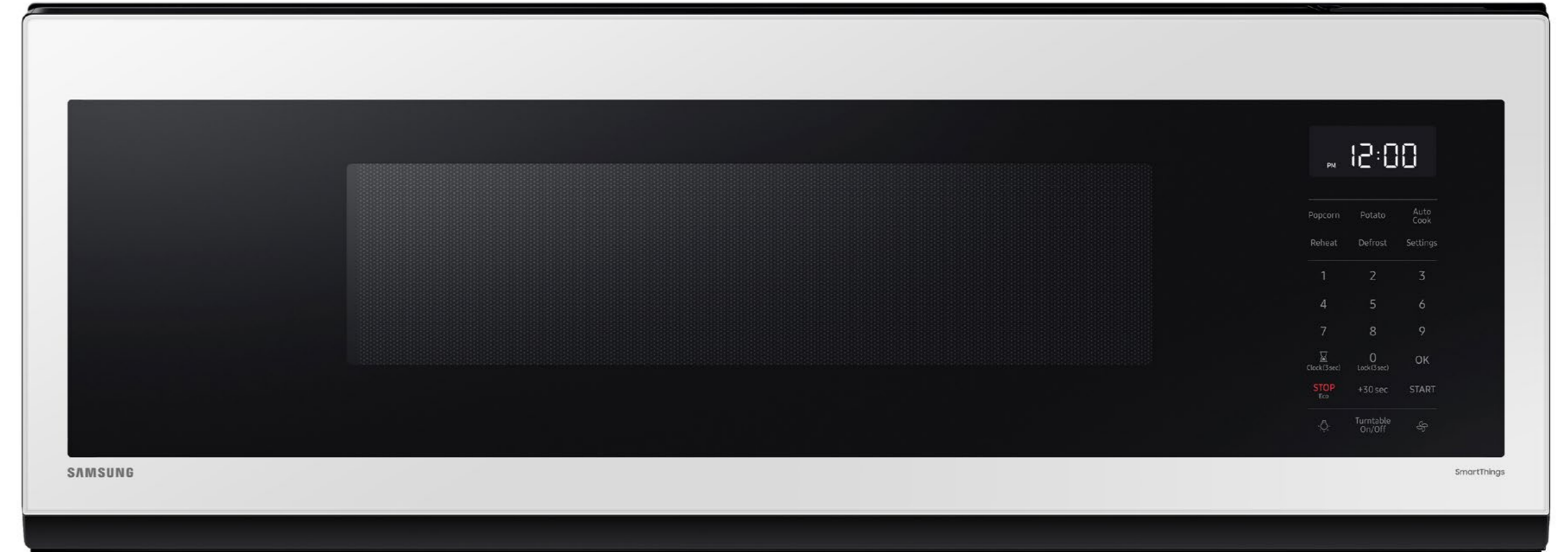

Easy Ads Links

Bespoke White Glass: <https://dam.gettyimages.com/p/z0c3461/digital-appliances?o=AND&q=ME11CB751012>

Note: Bespoke White Glass is a new SKU that requires product setup. Stainless Steel and Black Stainless Steel have already been set up.

Available Colors

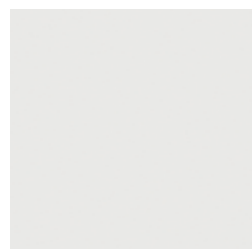

Bespoke White Glass
ME11CB751012



Fingerprint Resistant Stainless Steel
ME11A7510DS



Fingerprint Resistant Black Stainless Steel
ME11A7510DG

Carousel Image Order (Bespoke White Glass)



Available in fractions and decimals.

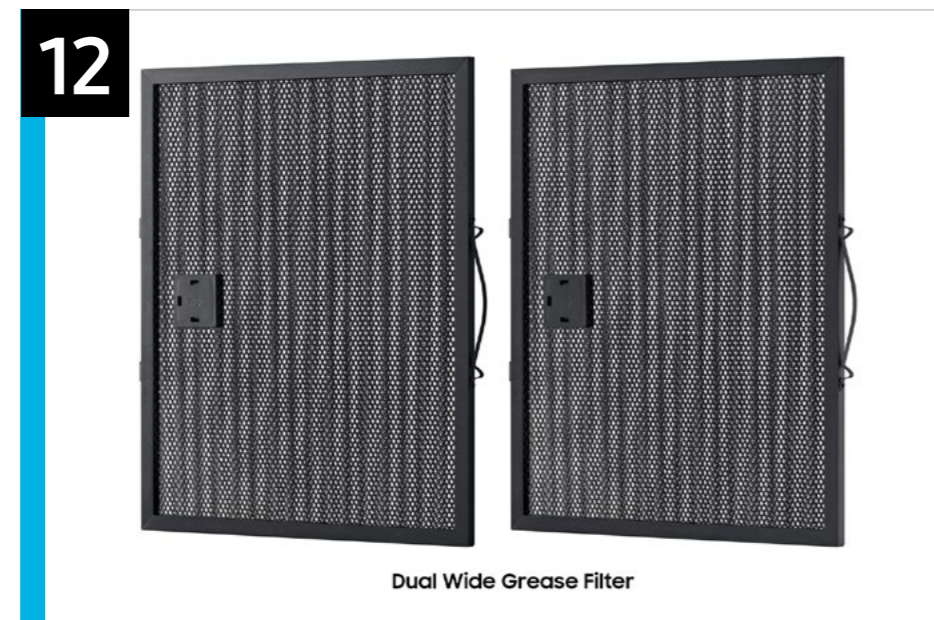



Carousel Image Order



Product Messaging

**1.1 cu. ft. Bespoke Smart SLIM Over-the-Range Microwave
with 400 CFM Hood Ventilation, Wi-Fi & Voice Control**



Features and Benefits – ME11*7510

Product Headline	Feature Name	Long Body Copy	Short Body Copy	Associated Image
<p>Style & space</p>	<p>Bespoke Design</p>	<p>Bespoke is Samsung’s premium line of home appliances, leading the way in design, technology, and connectivity. Create a kitchen that expresses your personal style.</p>	<p>Create a kitchen that expresses your personal style with Bespoke kitchen appliances.</p>	 <p>Note: Available only on ME11CB751012</p>
<p>Powerful ventilation</p>	<p>400 CFM Hood Ventilation</p>	<p>Even with its slim size, this hood has a powerful 400 CFM ventilation system that quickly removes steam and odors that result from cooking.</p>	<p>This hood has a powerful 400 CFM ventilation system that quickly removes steam and odors that result from cooking.</p>	 <p>Asset available as .gif file only.</p>
<p>Make cooking simple with smart technology</p>	<p>Wi-Fi and Voice Control</p>	<p>Using a voice assistant with the SmartThings App, like Samsung Bixby, Amazon Alexa, or Google Assistant, you can tell your microwave what you want it to do.* The SmartThings App lets you monitor and adjust settings or control the ventilation and lighting from anywhere.</p> <p><small>*Available on Android & iOS devices. A Wi-Fi connection and a Samsung account are required. Bixby is Samsung’s brand of Artificial intelligence (AI), Amazon Alexa and all related logos are trademarks of Amazon.com, Inc. or its affiliates. Google is a trademark of Google LLC.</small></p>	<p>Adjust settings with your voice or with your smartphone by using the SmartThings App. Using a voice assistant, like Samsung Bixby, Amazon Alexa, or Google Assistant, you can tell your microwave what you want it to do.*</p> <p><small>*Available on Android & iOS devices. A Wi-Fi connection and a Samsung account are required. Bixby is Samsung’s brand of Artificial intelligence (AI), Amazon Alexa and all related logos are trademarks of Amazon.com, Inc. or its affiliates. Google is a trademark of Google LLC.</small></p>	

Features and Benefits – ME11*7510 (Continued)

Product Headline	Feature Name	Long Body Copy	Short Body Copy	Associated Image
<p>Easy to keep clean</p>	<p>Ceramic Enamel Interior</p>	<p>A beautiful ceramic blue interior is easy to keep clean.</p>	<p>A beautiful ceramic blue interior is easy to keep clean.</p>	
<p>All shine</p>	<p>Fingerprint Resistant Finish</p>	<p>Fingerprint resistant for an everyday beautiful finish.</p>	<p>Fingerprint resistant, beautiful finish.</p>	 <p>Fingerprint resistant</p> <p>Note: Image should be customized by finish color for the respective model. Only available on stainless steel finish.</p>
<p>More power. Saves you time*</p> <p><small>*As compared to other Samsung Over-the-Range Microwave oven models.</small></p>	<p>1100 Watt Output Power</p>	<p>Save time with impressive 1100W output power that enables you to cook quickly and evenly. Larger dishes are cooked more thoroughly when the microwave has greater power performance.</p>	<p>Save time with impressive 1100W output power that enables you to cook quickly and evenly.</p>	

Features and Benefits – ME11*7510 (Continued)

Product Headline	Feature Name	Long Body Copy	Short Body Copy	Associated Image
<p>A hood that helps clean the air</p>	<p>Dual Wide Grease Filter</p>	<p>Improve hood performance by trapping more airborne particles such as oil and grease with the large dual wide grease filter built into the hood.</p>	<p>Improve hood performance by trapping more airborne particles with the dual wide grease filter.</p>	
<p>Brighten up your cooktop</p>	<p>Halogen Cooktop Light</p>	<p>Halogen lighting illuminates evenly over your entire cooktop.</p>	<p>Halogen lighting illuminates your cooktop.</p>	
<p>Fits your cooking essentials</p>	<p>1.1 cu. ft. Oven Capacity</p>	<p>This microwave oven cavity has a sizeable 1.1 cu. ft. capacity that can hold larger-sized cookware.</p>	<p>This microwave oven has a 1.1 cu. ft. capacity that can hold larger-sized cookware.</p>	 <p>Note: Asset is an MP4 file.</p>

Features and Benefits – ME11*7510 (Continued)

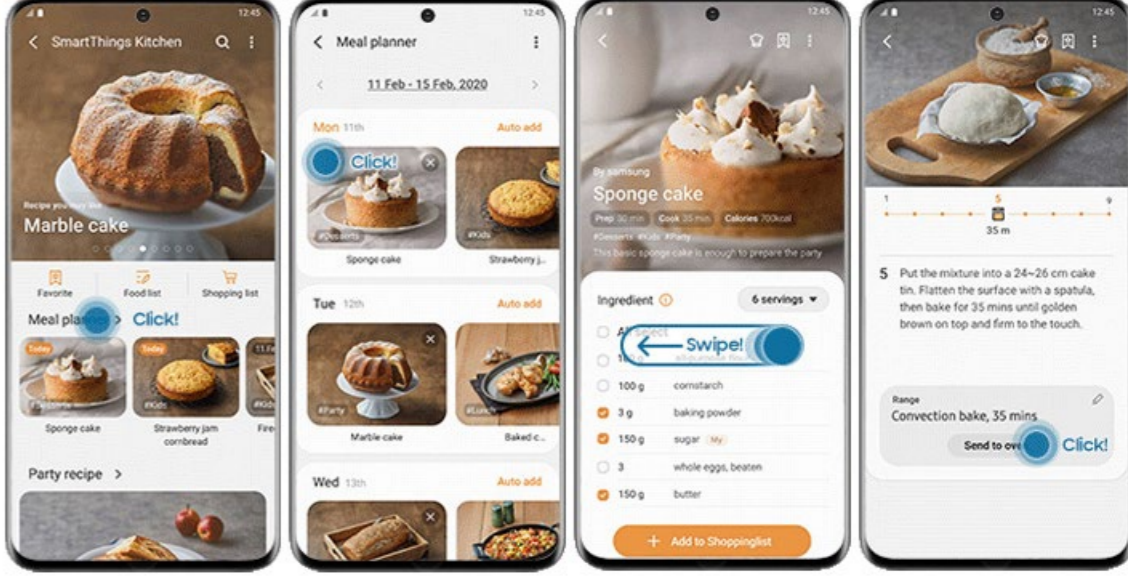
Product Headline	Feature Name	Long Body Copy	Short Body Copy	Associated Image
<p>Cooking with a personalized touch</p>	<p>SmartThings Cooking</p>	<p>Samsung’s SmartThings Cooking service makes meal planning a seamless process. Search, plan, purchase and prep weekly meals via the SmartThings App on your Family Hub™ refrigerator or smartphone.* SmartThings Cooking recommends personalized recipes based on preferences, shows what’s on hand, and tracks recipe search history so you can plan meals for your family more efficiently. Download the SmartThings App to create shopping lists and add missing ingredients directly to your grocery cart for at-home delivery.</p> <p><small>* Available on Android and iOS devices. A Wi-Fi connection and a Samsung account are required.</small></p>	<p>Search recipes, plan meals, and add any missing ingredients to your grocery cart for at-home delivery with SmartThings Cooking.*</p> <p><small>* Available on Android and iOS devices. A Wi-Fi connection and a Samsung account are required.</small></p>	

Lifestyle Images

**1.1 cu. ft. Bespoke Smart SLIM Over-the-Range Microwave
with 400 CFM Hood Ventilation, Wi-Fi & Voice Control**

Lifestyle Images



Product Videos

**1.1 cu. ft. Bespoke Smart SLIM Over-the-Range Microwave
with 400 CFM Hood Ventilation, Wi-Fi & Voice Control**

Product Videos

Product Video



Feature Videos

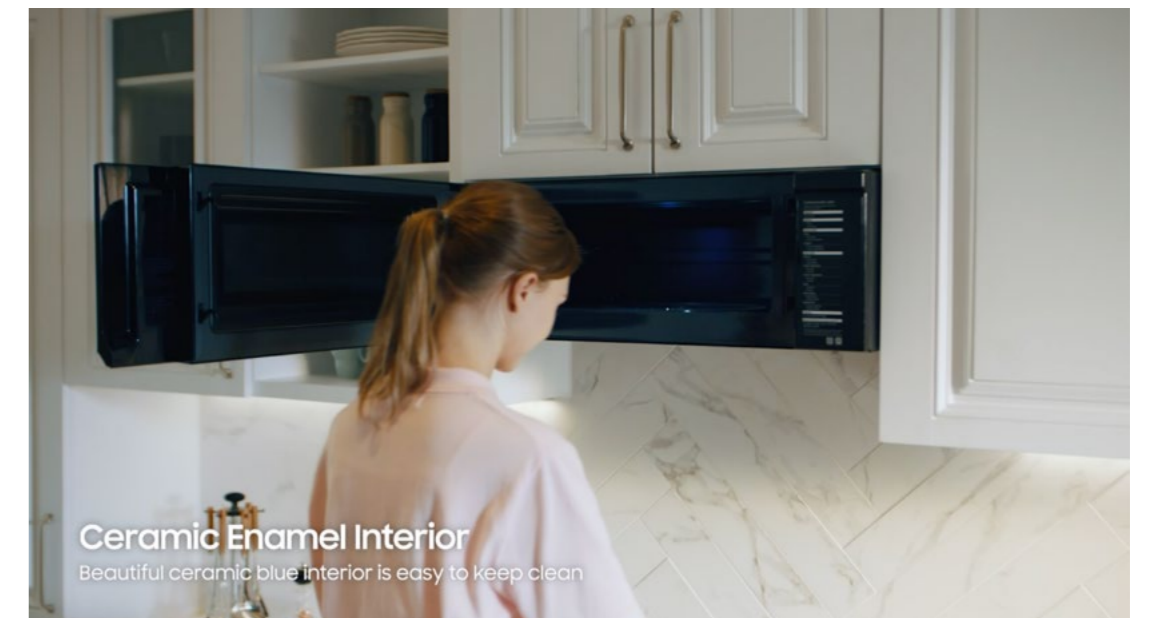
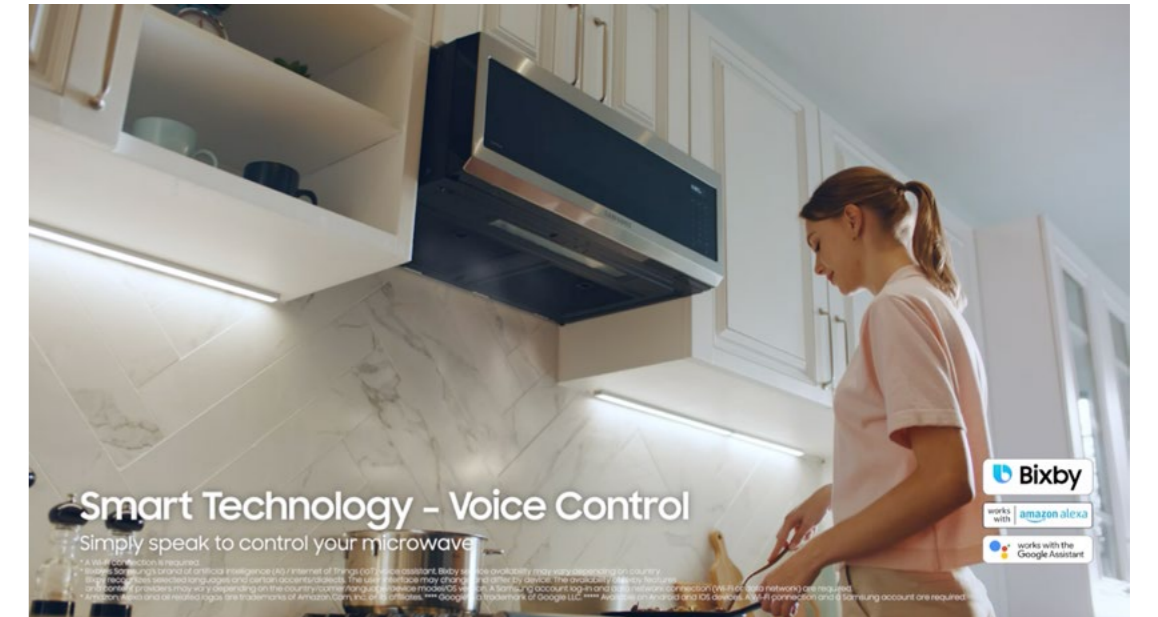
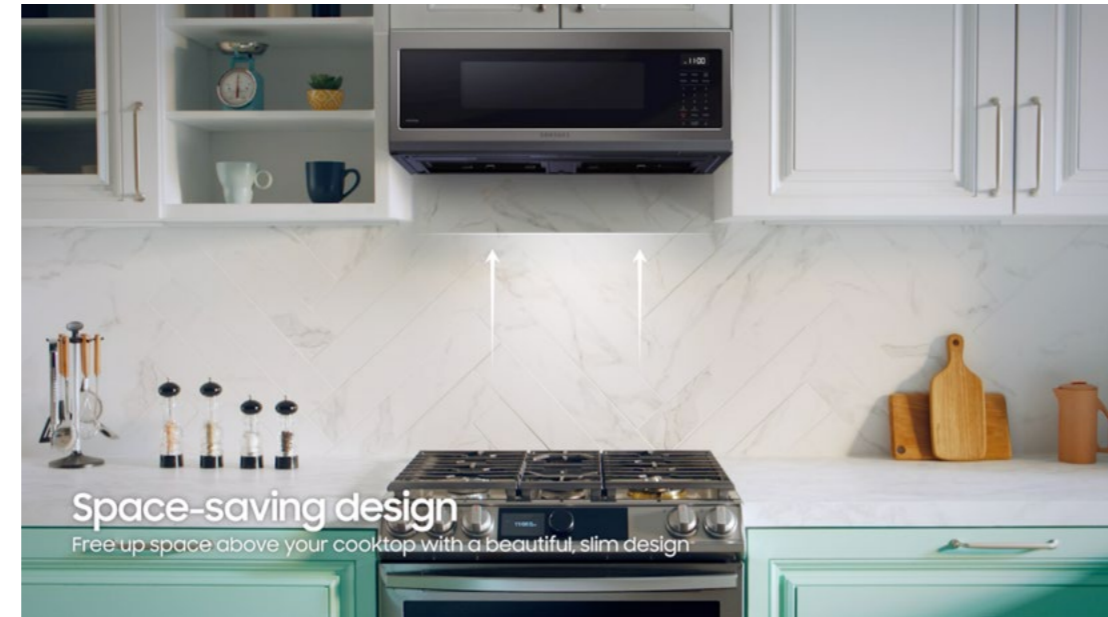

Product Specs

**1.1 cu. ft. Bespoke Smart SLIM Over-the-Range Microwave
with 400 CFM Hood Ventilation, Wi-Fi & Voice Control**

Review Mapping

Model #	Type	Color
ME11CB751012	SLIM Over-the-Range Microwave	Bespoke White Glass
ME11A7510DS	SLIM Over-the-Range Microwave	Fingerprint Resistant Stainless Steel
ME11A7510DG	SLIM Over-the-Range Microwave	Fingerprint Resistant Black Stainless Steel

Related Products

COLOR	PRODUCT	MODEL
Bespoke White Glass	29 cu. ft. Smart Bespoke 4-Door Flex™ Refrigerator with Customizable Panel Colors	RF29A9675AP
	23 cu. ft. Smart Counter Depth Bespoke 4-Door Flex™ Refrigerator with Customizable Panel Colors	RF23A9675AP
	Bespoke 4-Door Flex™ Refrigerator Panel in Bespoke White Glass - Top Panel	RA-F18DUU35
	Bespoke 4-Door Flex™ Refrigerator Panel in Bespoke White Glass - Bottom Panel	RA-F18DBB35
	6.3 cu. ft. Smart Bespoke Slide-in Electric Range in Bespoke White Glass	NE63BB871112
	6.0 cu. ft. Smart Bespoke Slide-in Gas Range in Bespoke White Glass	NX60BB871112
	30" Smart Induction Cooktop with Wi-Fi in Black	NZ30A3060UK
	Smart Bespoke Dishwasher with StormWash+™ 42dBA with Smart Dry	DW80BB707012

Spec Sheet

Easy Ads link

https://dam.gettyimages.com/p/z0c3461/external?o=AND&q=ME11A7510D*%20Spec%20sheet

ME11CB751012

1.1 cu. ft. Bespoke Smart SLIM Over-the-Range Microwave with 400 CFM Ventilation, Wi-Fi & Voice Control

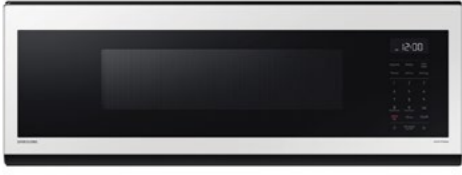

Signature Features

Slim Design

- Open up space above your cooktop with the new, beautifully designed Smart SLIM Over-the-Range Microwave. This combination microwave and hood packs in powerful performance and technology you love in a slim, space-efficient size.

Samsung SmartThings

- Adjust settings with your voice or with your smartphone by using the SmartThings App.* Using a voice assistant, like Samsung Bixby, Amazon Alexa, or Google Assistant, you can tell your microwave what you want it to do.

*Available on Android & iOS devices. A Wi-Fi connection and a Samsung account are required. Bixby is Samsung's brand of artificial intelligence (AI). Amazon Alexa and all related logos are trademarks of Amazon.com, Inc. or its affiliates. Google is a trademark of Google LLC. This app also supports iOS 7 or later for iPhone models. SmartThings App available in App Store and Play Store.

400 CFM Hood Ventilation with Hood Connectivity

- This hood has a powerful 400 CFM ventilation system that quickly removes steam, grease and odors that result from cooking.

SAMSUNG

Available Colors

- White Glass
- Fingerprint Resistant Stainless Steel
- Fingerprint Resistant Black Stainless Steel



Wi-Fi and Voice Control



400 CFM Hood Ventilation

Features

- Slim Design
- Wi-Fi and Voice Control
- 400 CFM Ventilation System
- Ceramic Enamel Interior
- SmartThings Cooking*
- 1.1 cu. ft. Oven Capacity
- Glass Touch Controls
- 1100 Watts of Cooking Power
- 10 Power Levels

Convenience

- Auto Defrost/Power
- Auto Cook
- Recessed Handle
- Change Filter Reminder
- LED Display
- Clock (12 hr/24 hr) with Daylight Saving Time Adjustment
- Kitchen Timer
- Weight Option
- End Signal
- Interior Light: LED
- Cooktop Lighting: Halogen
- Vent Fan Control: Boost/Hi/Mid/Lo/Off
- Child Safety Lock
- Sound On/Off
- Eco Mode (Reduces Standby Power)
- Wide Grease Filters (2)

ME11CB751012

1.1 cu. ft. Bespoke Smart SLIM Over-the-Range Microwave with 400 CFM Ventilation, Wi-Fi & Voice Control

Dimensions

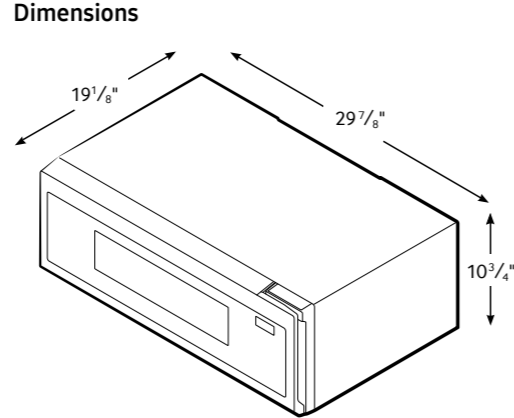

Specifications

- Oven Cavity: 1.1 cu. ft.
- Power Output: 1100W
- Power Consumption: 1500 W/14.5 Amps
- Power Source: 120 V/60 Hz
- Control Method: Glass Touch
- Bespoke Finish Display: White LED
- Standard Finish Display: Ice Blue LED
- Cooking Control: 10 Power Levels, Including Defrost
- Cooking Timer: Digital, up to 99 Minutes, 99 Seconds
- Microwave Distribution System: Turntable
- Glass Turntable Diameter: 11 1/2"
- Vent Fan: 4-Speed/400 CFM
- Vent Fan Control: Boost/Hi/Mid/Lo/Off
- Interior Light: LED
- Cooktop Lighting: Halogen

Warranty

One (1) Year Parts and Labor
Ten (10) Years Parts on Magnetron

Product Dimensions & Weight (WxHxD)

Cavity Dimensions: 18 1/2" x 6 9/16" x 14 15/16"
Outside Net Dimensions: 29 7/8" x 10 3/4" x 19 1/8"
Weight: 56.7 lbs

Shipping Dimensions & Weight (WxHxD)

Dimensions: 33 7/8" x 15 1/16" x 22 7/8"
Weight: 63.1 lbs

Bespoke Finish	Model #	UPC Code
White Glass	ME11CB751012	887276760582
Fingerprint Resistant Stainless Steel	ME11A7510DS	887276551449
Fingerprint Resistant Black Stainless Steel	ME11A7510DG	887276577401

Standard Finishes

Fingerprint Resistant Stainless Steel
Fingerprint Resistant Black Stainless Steel

Installing Your Microwave

- This microwave oven is designed for adaptation to the following three types of ventilation:
 - Outside Top Exhaust (Vertical Duct)
 - Recirculating (Non-vented Ductless)
 - Outside Back Exhaust (Horizontal Duct)
- The space between the cabinets must be 30" wide and free of obstructions.
- This microwave oven is for installation over ranges up to 36" wide.
- The microwave must be level. Use a level to make sure the cabinet bottom is level. If the cabinets have a front overhang only, with no back or side frame, install the mounting plate down the same distance as the front overhang depth. This will keep the microwave level.

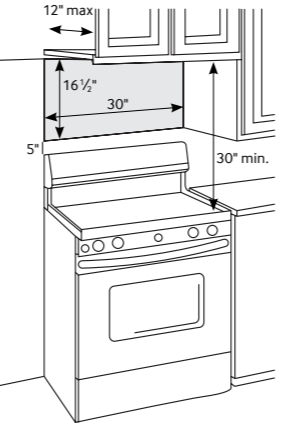

FOR EASIER INSTALLATION AND PERSONAL SAFETY, WE RECOMMEND THAT TWO PEOPLE INSTALL THIS MICROWAVE OVEN. IMPORTANT: Do not grip or use handle during installation.

NOTE: If your cabinet is metal, use the nylon grommet around the power cord hole to prevent cutting of the cord.

NOTE: We recommend using filler blocks if the cabinet front hangs below the cabinet bottom shelf.

IMPORTANT: If filler blocks are not used, case damage may occur from overtightening screws.

NOTE: When mounting the microwave oven, thread power cord through hole in bottom of top cabinet. Do not pinch cord or lift oven by pulling cord.

Actual color may vary. Design, specifications, and color availability are subject to change without notice. Non-metric weights and measurements are approximate.
©2023 Samsung Electronics America, Inc., 85 Challenger Road, Ridgefield Park, NJ 07660. Tel: 800-SAMSUNG. samsung.com. Samsung is a registered trademark of Samsung Electronics Co., Ltd.

Spec Sheet - front

Spec Sheet - back

User Manual and Warranty Information

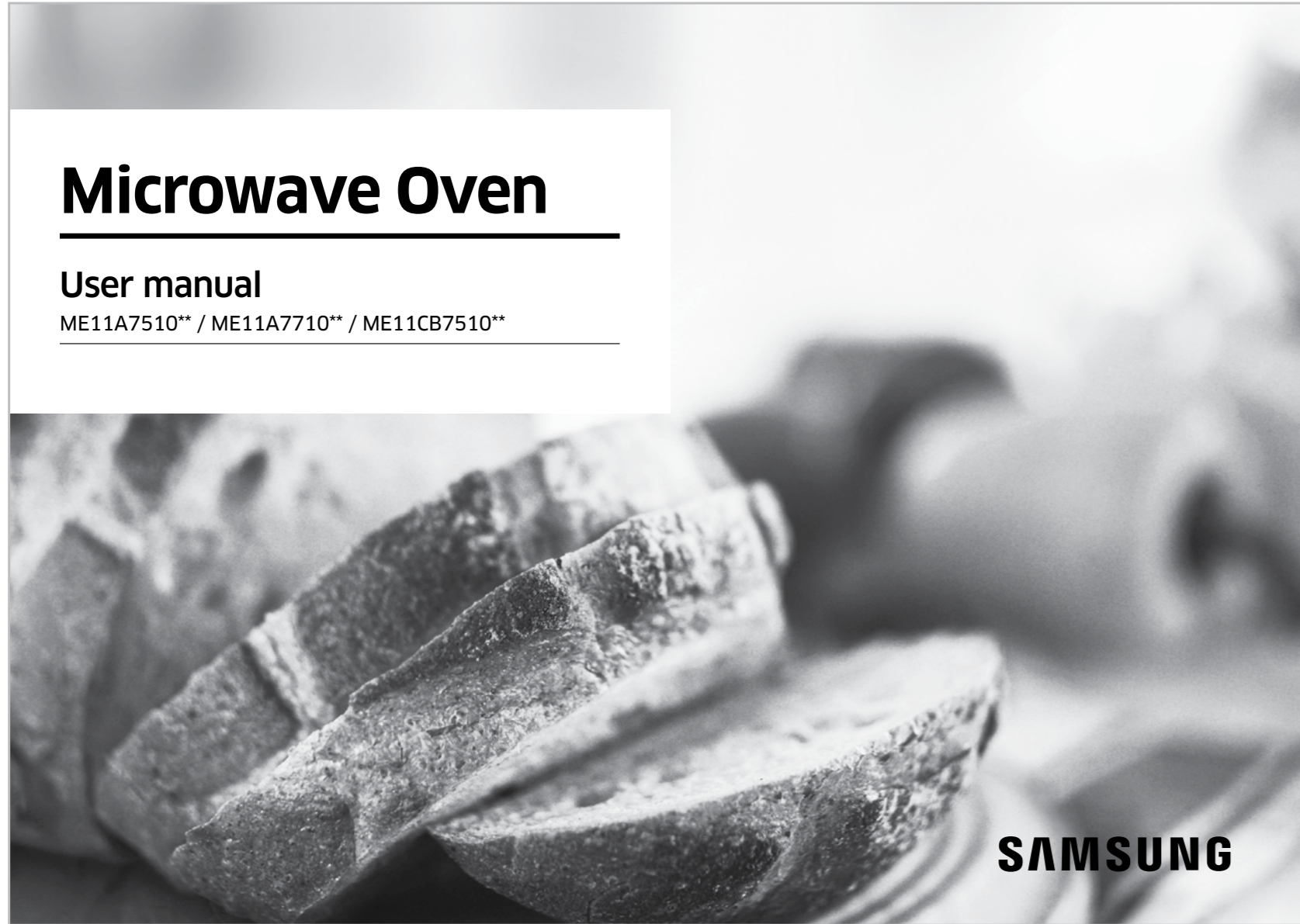

User Manual



Installation Manual

LIMITED WARRANTY (U.S.A.) – SAMSUNG Over-the-Range (OTR) Microwave Oven

Models:
ME11CB751012
ME11A7510DS
ME11A7510DG

LIMITED WARRANTY TO ORIGINAL PURCHASER WITH PROOF OF PURCHASE

This SAMSUNG brand product, as supplied and distributed by SAMSUNG ELECTRONICS AMERICA, INC. (SAMSUNG) and delivered new, in the original carton to the original consumer purchaser, is warranted by SAMSUNG against manufacturing defects in materials or workmanship for the limited warranty period, starting from the date of original purchase, of:

One (1) Year Parts and Labor
Ten (10) Years Magnetron Part (Part Only)

This limited warranty is valid only on products purchased and used in the United States that have been installed, operated, and maintained according to the instructions attached to or furnished with the product. To receive warranty service, the purchaser must contact SAMSUNG at the address or phone number provided below for problem determination and service procedures. Warranty service can only be performed by a SAMSUNG authorized service center. The original dated bill of sale must be presented upon request as proof of purchase to SAMSUNG or SAMSUNG's authorized service center to receive warranty service.

SAMSUNG will provide in-home service within the contiguous United States during the warranty period at no charge, subject to availability of SAMSUNG authorized servicers within the customer's geographic area. If in-home service is not available, SAMSUNG may elect, at its option, to provide transportation of the product to and from an authorized service center. If the product is located in an area where service by a SAMSUNG authorized servicer is not available, you may be responsible for a trip charge or required to bring the product to a SAMSUNG authorized service center for service.

To receive in-home service, product must be unobstructed and accessible to the service agent.

During the applicable warranty period, a product will be repaired, replaced, or the purchase price refunded, at the sole option of SAMSUNG. SAMSUNG may use new or reconditioned parts in repairing a product, or replace the product with a new or reconditioned product. Replacement parts and products are warranted for the remaining portion of the original product's warranty or ninety (90) days,

Warranty

Feature Icons

**1.1 cu. ft. Bespoke Smart SLIM Over-the-Range Microwave
with 400 CFM Hood Ventilation, Wi-Fi & Voice Control**

Feature Icons

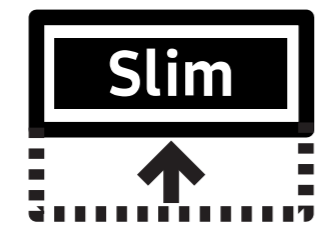

Space Efficient Size

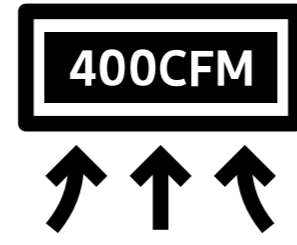

400 CFM Hood Ventilation

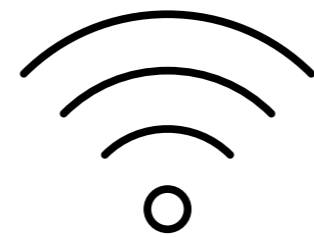

Wi-Fi Connectivity



Fingerprint Resistant Finish
*Only available on stainless steel finish.

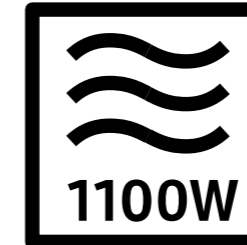

1100 Watt Output Power



Halogen Cooktop Light

SAMSUNG