



# OWNER'S MANUAL

# WASHING MACHINE

---

Read this owner's manual thoroughly before operating the appliance and keep it handy for reference at all times.

**ENGLISH**

WD300C\*



MFL71887217  
Rev.00\_062322

[www.lg.com](http://www.lg.com)

Copyright © 2022 LG Electronics Inc. All Rights Reserved.

# TABLE OF CONTENTS

## 3 IMPORTANT SAFETY INSTRUCTIONS

---

- 3 READ ALL INSTRUCTIONS BEFORE USE
- 3 WARNING STATEMENTS
- 7 CAUTION STATEMENTS

## 8 PRODUCT OVERVIEW

---

- 8 Product Features

## 10 INSTALLATION

---

- 10 Before Installing
- 10 Choosing the Proper Location
- 11 Stacking Pedestal Washer and Front-Loading Washer
- 12 Connecting the Water Inlet Hoses
- 14 Connecting the Drain Hose
- 15 Leveling the Washer

## 17 OPERATION

---

- 17 Before Use
- 18 Sorting Laundry & Loading the Washer
- 19 Adding Cleaning Products
- 21 Control Panel and Wash Cycles
- 24 Options
- 24 Setting

## 26 SMART FUNCTIONS

---

- 26 Using LG ThinQ Application
- 28 Smart Diagnosis<sup>TM</sup> Function

## 30 MAINTENANCE

---

- 30 Regular Cleaning
- 30 Periodic Maintenance

## 34 TROUBLESHOOTING

---

- 34 Before Calling for Service

## 41 LIMITED WARRANTY

---

- 41 USA
- 45 CANADA

# IMPORTANT SAFETY INSTRUCTIONS

## READ ALL INSTRUCTIONS BEFORE USE

### Safety Messages

**Your safety and the safety of others are very important.**

We have provided many important safety messages in this manual and on your appliance. Always read and follow all safety messages.



This is the safety alert symbol.

This symbol alerts you to potential hazards that can kill or injure you and others. All safety messages will follow the safety alert symbol and either the word WARNING or CAUTION.

These words mean:



### **WARNING**

You may be killed or seriously injured if you do not follow instructions.



### **CAUTION**

You may be injured or cause damage to the product if you do not follow instructions.

All safety messages will tell you what the potential hazard is, tell you how to reduce the chance of injury, and tell you what may happen if the instructions are not followed.

## WARNING STATEMENTS

### **! WARNING**

- To reduce the risk of explosion, fire, death, electric shock, scalding or injury to persons when using this product, follow basic precautions, including the following:

### **Installation**

- Adhere to all industry recommended safety procedures including the use of long-sleeved gloves and safety glasses.
- Never attempt to operate this appliance if it is damaged, malfunctioning, partially disassembled, or has missing or broken parts, including a damaged cord or plug.
- Before use, the appliance must be properly installed as described in this manual.
- To reduce the risk of severe injury or death, follow all installation instructions.
- Refer to the INSTALLATION INSTRUCTIONS for detailed grounding procedures. Installation instructions are packed with the appliance for the installer's reference. If the appliance is moved to a new location, have it checked and reinstalled by qualified service personnel.
- Moving or installation of the appliance requires two or more people.
- Do not install the appliance in humid spaces.
- Store and install the appliance where it will not be exposed to temperatures below freezing or exposed to outdoor weather conditions.
- This appliance is not designed for maritime use or for mobile installations such as in RVs, trailers, or aircraft.
- Keep packing materials out of the reach of children. Packaging material can be dangerous for children. There is a risk of suffocation.

## 4 IMPORTANT SAFETY INSTRUCTIONS

---

- Destroy the carton, plastic bag, and other packing materials after the appliance is unpacked. Children might use them for play. Cartons covered with rugs, bedspreads, or plastic sheets can become airtight chambers.
- The appliance must be installed and electrically grounded by qualified service personnel in accordance with local codes.
- When installing or moving the appliance, be careful not to pinch, crush, or damage the power cord.
- Connect to a properly rated, protected, and sized power circuit to avoid electrical overload.
- This appliance must be positioned near to an electrical power supply.
- Disconnect the power cord, house fuse or circuit breaker before installing or servicing the appliance.
- The power cord of this appliance is equipped with a 3-prong (grounding) plug which mates with a standard 3-prong (grounding) wall outlet to minimize the possibility of electric shock from this appliance.
- Do not, under any circumstances, cut or remove the third (ground) prong from the power cord.
- Use new hoses when connecting the washer to the water supply. Do not reuse old hoses.
- If installing the pedestal washer with an LG front-loading washer and an LG gas dryer, and insufficient outlets are available, an extension cord rated at no less than the branch circuit may be used.
- The pedestal washer is for installation and use only underneath an LG front-loading washer manufactured after 2009. A special kit is also available to allow use under an LG top-load-matching dryer manufactured in 2016 or later. Do not use the pedestal washer as a standalone unit, under an LG top-loading washer, or under any other washer or dryer.

### Operation

- Read all instructions before using the appliance and save these instructions.
- Use this appliance only for its intended purpose.
- If the product has been submerged in water, sitting in standing water, or waterlogged, do not come in contact with the product and immediately contact an LG Electronics Customer Information Center for instructions before resuming use.
- If you detect a strange sound, a chemical or burning smell, or smoke coming from the appliance, unplug it immediately, and contact an LG Electronics Customer Information Center.
- Under certain conditions, hydrogen gas may be produced in a hot-water system that has not been used for two weeks or more. HYDROGEN GAS IS EXPLOSIVE. If the hot-water system has not been used for such a period, before using the appliance, turn on all hot water faucets and let the water flow from each for several minutes. This will release any accumulated hydrogen gas. As the gas is flammable, do not smoke or use an open flame during this time.
- Do not reach into the washer if the tub or drum, agitator, or any interior parts are moving. Before loading, unloading, or adding items, press Start/Pause and allow the tub or drum to coast to a complete stop before reaching inside.
- This appliance is not intended for use by persons (including children) with reduced physical, sensory or mental capabilities, or lack of experience and knowledge, unless they have been given supervision or instruction concerning the use of the appliance by a person responsible for their safety.
- Do not allow children or pets to play on, in or with the appliance. Close supervision is necessary when the appliance is used near children or pets.
- Keep laundry products out of children's reach. To prevent injury to persons, observe all warnings on product labels.
- Repair or immediately replace all power cords that have become frayed or otherwise damaged. Do not use a cord that shows cracks or abrasion damage along its length or at either end.
- Never unplug the appliance by pulling on the power cord. Always grip the plug firmly and pull straight out from the outlet.
- Do not use an extension cord or adapter with this appliance.
- Do not grasp the power cord or touch the appliance controls with wet hands.

- Do not modify or extend the power cord.
- If the electrical supply cord is damaged, it must only be replaced by the manufacturer or its service agent or a similar qualified person in order to avoid a hazard.
- Do not put oily or greasy clothing, candles or flammable materials on top of the appliance.
- Keep the area underneath and around your appliances free of combustible materials (lint, paper, rags, etc.), gasoline, chemicals and other flammable vapors and liquids.
- Do not store or use gasoline or other flammable vapors and liquids in the vicinity of this or any other appliance.
- Do not mix chlorine bleach with ammonia or acids such as vinegar. Follow package directions when using laundry products. Incorrect usage can produce poisonous gas, resulting in serious injury or death.
- Never use harsh chemicals, abrasive cleaners, or solvents to clean the washer. They will damage the finish.
- Do not wash laundry that has been previously cleaned in, washed in, soaked in, or spotted with gasoline, dry-cleaning solvents, vegetable or cooking oil, or other flammable or explosive substances, as they give off vapors that could ignite or explode.
- Do not add gasoline, dry cleaning solvents, or other flammable or explosive substances to the wash water. These substances give off vapors that could ignite or explode.
- In the event of a gas leak (propane gas, LP gas, etc.), do not operate this or any other appliance. Open a window or door to ventilate the area immediately.
- Fix the drain hose securely in place to avoid flooding.
- Always check the inside of the appliance for foreign objects.
- Do not allow water, bleach or other liquids to sit in the drum for extended periods. Doing so can corrode the drum or cause mildew or odors.
- Do not wash rugs, mats, shoes, pet bedding, or any items other than clothes or sheets, in this washer.
- Do not tamper with controls and the stacking switch.
- Do not operate the pedestal washer with two or more pedestal washers stacked.
- Keep hands and foreign objects clear of the lid and latch area when closing the lid.
- To avoid breaking the lid glass, do not push too hard on the lid when closing.
- Do not open or close the lid by foot. Do not step on the pedestal washer.

## Maintenance

- Do not repair or replace any part of the appliance. All repairs and servicing must be performed by qualified service personnel unless specifically recommended in this owner's manual. Use only authorized factory parts.
- Disconnect this appliance from the power supply before cleaning and attempting any user maintenance. Turning the controls to the OFF position does not disconnect this appliance from the power supply.
- Remove any dust or foreign matter from the power plug pins.
- Do not disassemble or repair the appliance by yourself.
- Remove the lid before the appliance is removed from service or discarded to avoid the danger of children or small animals getting trapped inside.

## Grounding Instructions

- Improper connection of the equipment-grounding conductor can result in a risk of electric shock. Check with a qualified electrician or service personnel if you are in doubt whether the appliance is properly grounded. Do not modify the plug provided with the appliance; if it will not fit the outlet, have a proper outlet installed by a qualified electrician.

## 6 IMPORTANT SAFETY INSTRUCTIONS

---

- The appliance must be grounded. In the event of a malfunction or breakdown, grounding will reduce the risk of electric shock by providing a path of least resistance for electric current. The appliance is equipped with a cord having an equipment-grounding conductor and a grounding plug. The plug must be plugged into an appropriate outlet that is installed and grounded in accordance with all local codes and ordinances.

---

## CAUTION STATEMENTS

---

### CAUTION

- To reduce the risk of minor or moderate injury to persons, malfunction, or damage to the product or property when using this product, follow basic precautions, including the following:
- 

### Installation

- Install the product on a firm and level floor.

### Operation

- Do not place objects on top of the appliance.
- Turn off the water faucets and unplug the appliance if the appliance is to be left for an extended period of time, such as during vacations.
- ALWAYS follow the fabric care instructions supplied by the garment manufacturer.
- Use fabric softeners or products to eliminate static only as recommended by the manufacturer.
- Do not combine laundry products for use in one load unless specified on the label.
- Do not touch draining water which may be hot.
- If the drain hose and the water inlet hose are frozen in winter, defrost them before using the appliance.
- Do not store or spill liquid detergents, cleaners, or bleaches (chlorine bleach, oxygen bleach) on the appliance. Doing so may result in corrosion, discoloration or damage to the surface of the appliance.

**SAVE THESE INSTRUCTIONS**

# PRODUCT OVERVIEW

## Product Features

The images in this guide may be different from the actual components and accessories, which are subject to change by the manufacturer without prior notice for product improvement purposes.

### ⚠ WARNING

- For your safety and for extended product life, use only authorized components. The manufacturer is not responsible for product malfunction, property damage or bodily injury caused by the use of separately purchased unauthorized components, parts, or non-LG products.

### Front View

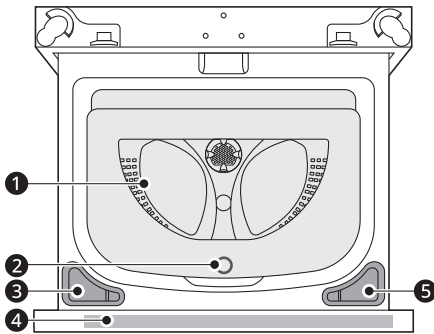

- ❶ Drum
- ❷ Lid Open/Close Button
- ❸ Liquid Detergent Dispenser
- ❹ Control Panel
- ❺ Liquid Softener Dispenser

### Rear View

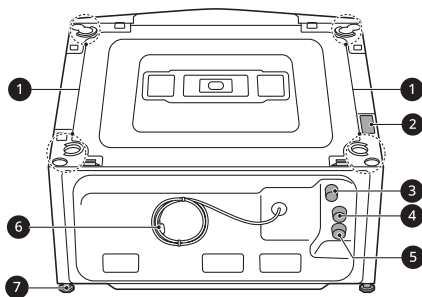

- ❶ Main Washer Legs
- ❷ Stacking Switch
- ❸ Drain Outlet
- ❹ Cold Water Inlet
- ❺ Hot Water Inlet

- ❻ Power Plug
- ❼ Levelling Feet

### Accessories

#### Included Accessories

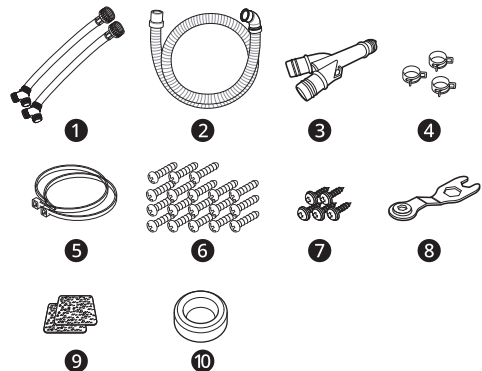

- ❶ Connecting Supply Hoses (2EA)
- ❷ Water Drain Hose
- ❸ Water Drain Hose Connector
- ❹ Band Clamps (3 EA)
- ❺ Cable Ties (2 EA)
- ❻ Long Sheet Metal Screws (18 EA)
- ❼ Short Sheet Metal Screws (5 EA)
- ❽ Wrench
- ❾ Non-skid Pads (2EA)
- ❿ Detergent Dispenser



## Required Accessories

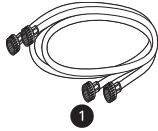

- ❶ Cold and Hot Water Supply Hoses

### NOTE

- Contact LG Customer Service at 1-800-243-0000 (1-888-542-2623 in Canada) if any accessories are missing or to purchase accessories. For a list of LG front-loading washers which are compatible with the pedestal washer, visit the LG website at [www.lg.com](http://www.lg.com)

## Product Specifications

| Model                                  | WD300C*   |
|--|---|
| Electrical Requirements                | 120 V~, 60 Hz   |
| Min. / Max. Water Pressure             | 20 psi - 120 psi (138 kPa - 827 kPa)  |
| Dimensions<br>(Width X Height X Depth) | 27" (W) x 14 1/8" (H) x 30 3/4" (D), 50 1/2"(D when open)<br>68.9 cm (W) x 36.5 cm (H) x 77.0 cm (D), 128.3 cm(D when open) |
| Net Weight                             | 105 lb (47.8 kg)  |
| Max. Spin Speed                        | 700 RPM   |

# INSTALLATION

## Before Installing

### Tools Needed



- ❶ Pliers
- ❷ Flat-Blade Screwdriver
- ❸ Level

### NOTE

- For instructions on stacking under a top-load-matching dryer, see the instructions in the dryer stacking kit which is available on LG.com.

Scan the QR code to link directly to an install video tutorial.



## Installation Overview

Please read the following installation instructions first after purchasing this washer or transporting it to another location.

- ❶ Choosing the Proper Location
- ❷ Stacking Pedestal Washer and Front-Loading Washer
- ❸ Connecting the Inlet Hoses
- ❹ Connecting the Drain Hose
- ❺ Leveling the Washer

### ⚠ WARNING

- Moving or installation of the appliance requires two or more people. Failure to follow these instructions may result in injury.
- Store and install the appliance where it will not be exposed to temperatures below freezing or exposed to outdoor weather conditions. Failure to follow this warning can cause product or part failure, serious injury, fire, electric shock, or death.

- Properly ground the washer to conform with all governing codes and ordinances. Failure to follow this warning can cause serious injury, fire, electric shock, or death.
- To ensure proper airflow, do not block the large opening on the bottom of the washer with carpeting or other materials.
- Do not remove the ground prong from the power cord. Do not use an adapter or extension cord. Plug into a grounded 3-prong outlet. Failure to follow this warning can cause serious injury, fire, electric shock, or death.
- Certain internal parts are intentionally not grounded and may present a risk of electric shock only during servicing. Service personnel- Do not contact the following parts while the appliance is energized: pump, valve, motor, control board.
- The pedestal washer is for installation and use only underneath an LG front-loading washer manufactured after 2009. A special kit is also available to allow use under an LG top-load-matching dryer manufactured in 2016 or later. Do not use the pedestal washer as a standalone unit, under an LG top-loading washer, or under any other washer or dryer.

### NOTE

- The pedestal washer's width must match the stacked LG appliance's width.
- The pedestal washer will not work as a standalone unit.
- The pedestal washer must be stacked under an LG brand appliance in order to operate properly.

## Choosing the Proper Location

Check the following requirements for the install location before installing the washer.

- Allow for sufficient space between the walls and the washer for installation.
- Make sure that the floor is clean, dry and free of dust, dirt, water and oil so the leveling feet cannot slide easily. Leveling feet that can move or slide on the floor can contribute to excess vibration and noise.

- If the floor has too much flex, reinforce it to make it more rigid. If the floor is not solid, it may cause severe vibration and noise.

### Power Outlet

- The power outlet must be within **60 inches (1.5 m)** of either side of the washer.
- Position the washer so that the outlet and plug are easily accessible.
- Do not overload the outlet with more than one appliance.
- The outlet must be grounded in accordance with current electrical wiring codes and regulations.
- Use a time-delay fuse or circuit breaker.
- It is the personal responsibility and obligation of the washer owner to have a proper outlet installed by a qualified electrician.

### Flooring

- To minimize noise and vibration, install the washer on a level, solidly constructed floor capable of supporting the washer without flexing or bouncing.
- The washer must be installed on firm flooring to minimize vibration during the spin cycle. Concrete flooring is best, but a wood floor is sufficient, provided it is built to FHA standards.
- The floor under the washer must not slope more than 1 inch (2.5 cm) from front to back or side to side.
- Installing on carpeting and soft tile surfaces is not recommended.
- Never install the washer on a platform or weakly supported structure.

### Floor Installation

To ensure sufficient clearance for water inlet hoses, drain hose and airflow, allow minimum clearances of at least **1 inch (2.5 cm)** at the sides and **4 inches (10 cm)** behind the washer. Be sure

to allow for wall, door, or floor moldings that may increase the required clearances.

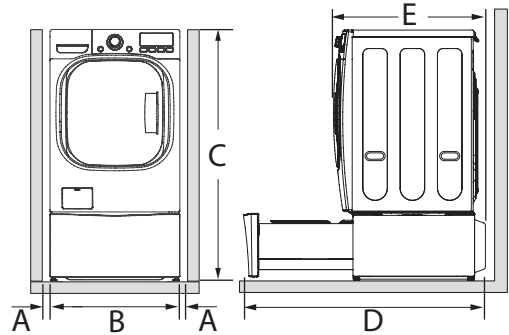

| Dimensions and Clearances |   |
|---------------------------|---|
| A                         | 1" (2.5 cm)                               |
| B                         | 27" (68.9 cm) or 29" (73.7 cm)            |
| C                         | 52 5/16" (132.9 cm) or 54 1/4" (137.8 cm) |
| D†                        | 50 1/2" (128.3 cm) or 52 3/4" (134 cm)    |
| E                         | 29 3/4" (75.6 cm) or 32" (82.1 cm)        |

† 20" (50.8 cm) additional needed for service

### NOTE

- Refer to the instructions packaged with the optional pedestal kit before stacking appliance on pedestal.
- Do not use a drain pan with a pedestal or pedestal washer installation as it can block the drawer. Using a drain pan may result in increased vibration and noise during operation.

## Stacking Pedestal Washer and Front-Loading Washer

### Unpacking and Removing Packing Materials

- 1 After removing the carton and shipping material, lift the pedestal washer off the foam base.
  - Make sure the plastic tub support comes off with the base and is not stuck to the bottom of the pedestal washer.

## 12 INSTALLATION

- Remove and save the foam block for future use.
  - If the pedestal washer must be moved in the future, the foam block will help prevent damage to the pedestal washer during transportation.
  - To prevent damage, do not remove the foam block until the pedestal washer is at the final location.

- Turn the top cover about 180 degrees, cover the opening in the top with the top cover and install 4 short sheet metal screws.

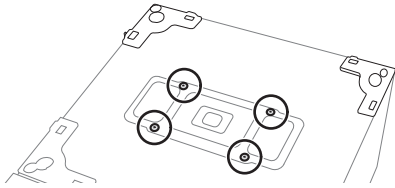

### Stacking the Front-Loading Washer on the Pedestal Washer

- Place the pedestal washer in the final location and adjust the leveling legs on the pedestal washer to level it. Fully retract the legs of the front-loading washer.
- Place the front-loading washer on top of the pedestal washer.
  - Place the leveling feet of the front-loading washer inside the bracket openings on the pedestal washer, and align the bracket screw holes.

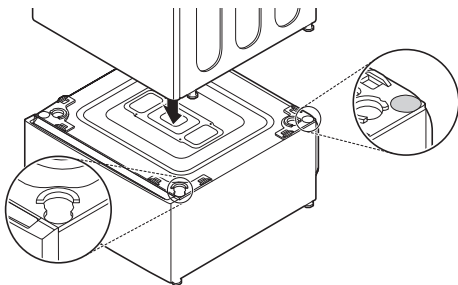

- Securely attach the two washers at the corners using screws.
  - First, insert screws on each side. Then insert screws on the front and back side.

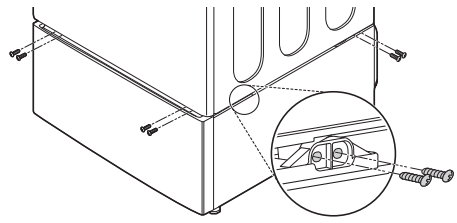

#### NOTE

- For best results, level the pedestal washer before stacking the front-loading washer on top of it, and insert the screws in the recommended order.

- Extend the feet of the front-loading washer slightly until the two washers are snug up against each other. To extend the adjustable feet, turn them clockwise for a half turn with a wrench. Then tighten the four lock nuts. All lock nuts must be tightened.

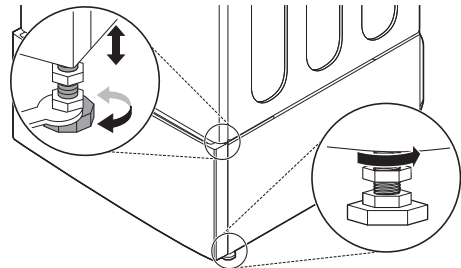

#### NOTE

- The pedestal washer will not work as a standalone unit.

### Connecting the Water Inlet Hoses

To avoid the risk of costly water damage, purchase and install new water inlet hoses when installing the washer.

#### ⚠ WARNING

- Do not overtighten the hoses or cross-thread the hose fittings. Overtightening or cross-threading can damage the valves or couplings, resulting in leaking and property damage.
- Do not reuse old hoses. Use only new hoses when installing the washer. Old hoses could leak or burst causing flooding and property damage.

Contact an LG Customer Information Center for assistance in buying hoses.

**NOTE**

- Periodically check the hoses for cracks, leaks, and wear, and replace the hoses every five years.
- Do not stretch the water hoses intentionally, and make sure that they are not pinched, crushed or kinked by other objects.
- Water supply pressure must be between **20 psi** and **120 psi (138 - 827 kPa)**. If the water supply pressure is more than **120 psi**, a pressure reducing valve must be installed.
- Your hot water heater should be set to deliver water at **120-135 °F (48-57 °C)** to allow the washer to properly control wash temperatures.
- Do not store or install the washer in a location subject to freezing temperatures. Damage to the water inlet hoses and internal mechanisms of the washer can result. If the washer was exposed to freezing temperatures prior to installation, allow it to stand at room temperature for several hours before use and check for leaks prior to operation.
- Do not use flood-preventing hoses with auto shut off devices. The devices can be tripped during fill and prevent the washer from filling properly.

**Overview of Connections**

† Required water inlet accessories

**Front-Loading Washer and Pedestal Washer with Dryer**

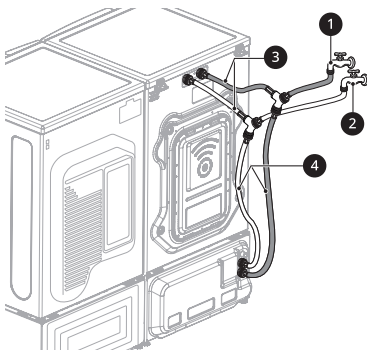

- ① Hot Water Tap
- ② Cold Water Tap
- ③ Short inlet hose (2 EA)†
- ④ Long inlet hose (4 EA)†

**Front-Loading Washer and Pedestal Washer with Turbo Steam Dryer**

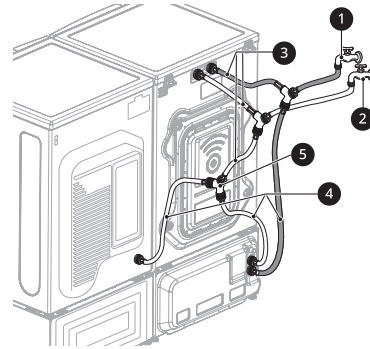

- ① Hot Water Tap
- ② Cold Water Tap
- ③ Short inlet hose (3 EA)†
- ④ Long inlet hose (5 EA)†
- ⑤ Y-Connector (1 EA)†

**How to Connect the Water Inlet Hoses**

- 1 Check the fittings and seals. Inspect the threaded fitting on each hose and make sure there is a rubber seal ① in place in both ends of each hose to prevent leaking.

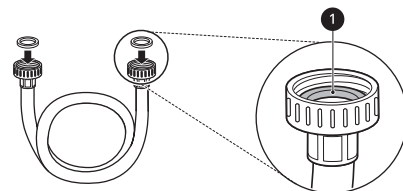

- 2 Connect the water supply hoses.
  - Connect the water inlet hoses to the hot and cold water faucets tightly by hand and then tighten another 2/3 turn with pliers.
  - Connect the blue hose to the cold water faucet and the red hose to the hot water faucet.

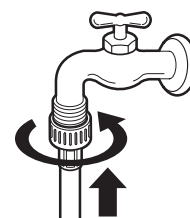

## 14 INSTALLATION

### 3 Flush out the inlet hoses.

- After the hoses are connected, turn on the water faucets and flush out any foreign substances such as dirt, sand, or sawdust.
- Let the water drain into a bucket, and check the water temperature to make sure you've connected the hoses to the correct faucets.

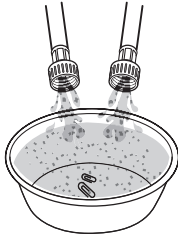

### 4 Attach the inlet hoses to the back of the washer.

- Attach the hot water inlet hose **2** to the hot water inlet on the back of the washer. Attach the cold water inlet hose **3** to the cold water inlet on the back of the washer.
- Tighten the fittings securely. Turn on both faucets all the way and check for leaks at both ends of the hoses.

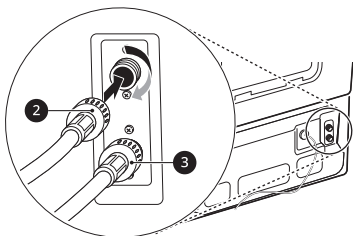

## Connecting the Drain Hose

### Overview of Connections

Connect the drain hose to either a standpipe or laundry tub.

#### **⚠ WARNING**

- The drain hose should always be properly secured. Failure to properly secure the drain hose can result in flooding and property damage.

#### **NOTE**

- The drain must be installed in accordance with any applicable local codes and regulations.
- Make sure that the drain hose is not stretched, pinched, crushed, or kinked.

- The end of the drain hose should be located a minimum of **24 inches (61 cm)** and a maximum of **96 inches (244 cm)** above the bottom of the washer.
- For best results, locate the end of the drain hose no higher than **66 inches (168 cm)** above the bottom of the washer. As the drain outlet is raised beyond **66 inches (168 cm)**, the drain function will be increasingly affected.
- Never create an airtight seal between the hose and the drain with tape or other means. If no air gap is present, water can be siphoned out of the drum resulting in poor wash/rinse performance or clothing damage.

### Front-Loading Washer and Pedestal Washer with Dryer

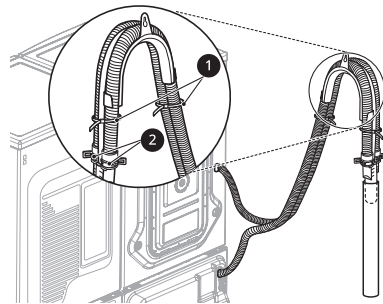

### Front-Loading Washer and Pedestal Washer with Hybrid Dryer

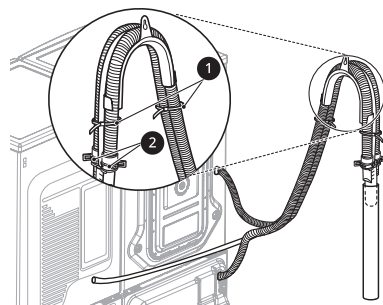

**1** Band Clamps

**2** Tie Straps

### Connecting the Drain Hose to the Pedestal Washer

- 1** Insert the band clamp onto the drain hose elbow. Pliers may be required to open the clamp so it can be fitted to the rubber end of the hose.

- 2 With the hose leading up from the elbow, firmly insert the elbow onto the drain outlet on the back of the pedestal washer.

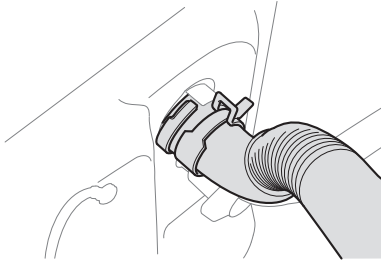

- 3 Adjust the band clamp with pliers to keep the hose securely in place and prevent leaking.

### Connecting the Drain Connector

- 1 Insert the included band clamps on to the ends of the two drain hoses.
- 2 Connect the drain hose of the front-loading washer and the pedestal washer to the drain connector.

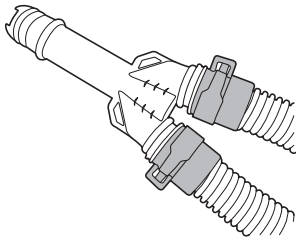

- 3 Insert the end of the drain hose connector into the laundry tub or standpipe. Use the band clamps to keep it in place, if needed.

#### NOTE

- Depending on the installation environment, you may have to purchase a separate drain hose connector. The connector supplied will suit a standard laundry tub-side standpipe.

## Leveling the Washer

### How to Level the Washer

- 1 Position the washer in its final location.
  - Take special care not to pinch, strain, or crush the water and drain hoses. If you have

a carpenter's level **1**, you can use it to check that the washer is level. The slope beneath the washer should not exceed  $1/2"$ , and all 4 leveling feet must rest firmly on the floor.

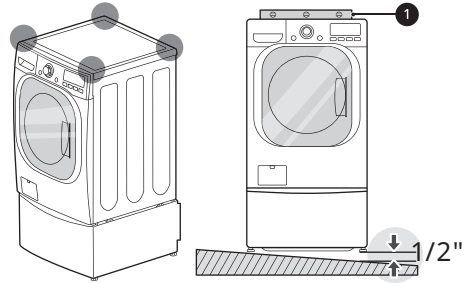

- 2 Adjust the leveling feet on the pedestal washer.
  - Turn all 4 leveling feet in one direction to raise the washer or the other direction to lower it.

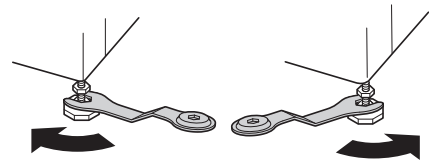

- 3 Check the level again.
  - Push or rock the top edges of the washer gently to make sure the washer does not rock. If the washer rocks, readjust the leveling feet.
- 4 Tighten the locknuts **2**.
  - Turn the locknuts counterclockwise and tighten them when the washer is level.

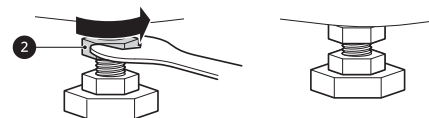

### Using Non-Skid Pads

If you install the washer on a slippery surface, it may move because of excessive vibration. Incorrect leveling may cause malfunction through noise and vibration. If this occurs, install the non-skid pads under the leveling feet and adjust the level.

## 16 INSTALLATION

---

- 1** Clean the floor to attach the non-skid pads.
  - Use a dry rag to remove and clean foreign objects or moisture. If moisture remains, the non-skid pads may slip.
- 2** Adjust the level after placing the washer in the installation area.
- 3** Place the adhesive side **3** of the non-skid pad on the floor.
  - It is most effective to install the non-skid pads under the front leveling feet. If it is hard to place the pads under the front leveling feet, place them under the back leveling feet.

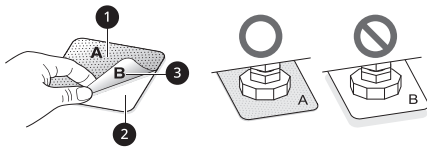

- 1** This side up
  - 2** Remove backing
- 4** Recheck the washer's levelness.
    - Push or rock the top edges of the washer gently to make sure the washer does not rock. If the washer rocks, level the washer again.



# OPERATION

## Before Use

### WARNING

- To reduce the risk of fire, electric shock, or injury to persons, read the SAFETY INSTRUCTIONS before operating this appliance.

### Operation Overview

#### 1 Sort laundry and load the washer.

- Sort laundry by fabric type, soil level, color and load size as needed. Open the lid and load items into the washer.
- If using a gel detergent, place it in the tub before loading the laundry.

### CAUTION

- Do not load items higher than the top edge of the tub. Failure to follow this caution can result in leakage or damage to fabrics.
- Use the Bedding cycle in the full-size washer for buoyant or nonabsorbent items such as pillows or comforters. Refer to the owner's manual included with the washing machine. Failure to follow this caution can result in leakage.

#### 2 Add cleaning products.

- Pour the proper amount of HE (High-Efficiency) detergent into the detergent dispenser.
- If desired, add liquid fabric softener to the softener dispenser.
- Do not use liquid or powdered detergent packs or tablet detergents in this washer, as they contain too much detergent.

#### 3 Turn on the washer.

- Press the **Power** button to turn on the washer.

#### 4 Select a cycle.

- Press the cycle selector button.
- The **Normal** cycle must be selected in order to change its default settings.
- Pressing the **Start/Pause** button without selecting a cycle immediately starts the **Normal** cycle with the default settings.

- The optional remote control can also be used to select the desired cycle.

#### 5 Add options.

- Options for the selected cycle can be selected, if desired, using the option buttons.
- Not all options are available on all cycles. A different chime sounds and the LED does not light up if the selection is not allowed.

#### 6 Begin cycle.

- Press down gently on the lid handle until it clicks and slide the drawer closed.
- Press the **Start/Pause** button to begin the cycle. The lid locks, and the washer agitates briefly without water to measure the weight of the load.
- If the **Start/Pause** button is not pressed within a certain time, the washer shuts off and all settings are lost.

#### 7 End of cycle.

- When the cycle is finished, a melody sounds. Immediately remove the clothing from the washer to reduce wrinkling.

## Sorting Laundry & Loading the Washer

### Grouping Similar Items

For the best washing results, and to reduce the possibility of damage to clothing, sort clothing into loads made up of similar items.

Mixing different fabric types and/or soil levels can result in poor wash performance, color transfer, discoloration, fabric damage or linting. Fabrics should be sorted into groups as described below.

### Colors

Sort articles by color. Wash dark clothes separately from light colors or whites. Mixing dark clothes with light clothes can result in dye transfer or discoloration of the lighter clothes.

### Soil Level

Wash heavily soiled clothing in the full-sized washer. Washing lightly soiled clothing in the same load with heavily soiled clothing could result in poor wash performance for the lightly soiled clothing. The pedestal washer is optimized for use with lightly soiled and delicate items.

### Fabric Type

Delicate articles should not be mixed with heavy or sturdy fabric types. Washing heavy fabrics with delicates can result in poor wash performance for the heavy fabrics and possible damage to the delicates.

### Lint Type











Some fabrics attract and bind lint to them while others give off lint in the laundry process. Avoid mixing these lint collectors and lint producers in the same load. Mixing these fabrics will result in pilling and linting on the lint collectors. (For example, lint collector - knit sweater; lint producer - terry cloth towels.)

### How to Sort Laundry

| By Colors | By Soil | By Fabric | By Lint        |
|-----------|---------|-----------|----------------|
| White     | Heavy   | Delicates | Lint Producer  |
| Lights    | Normal  | Easy Care | Lint Collector |
| Darks     | Light   | Sturdy    |                |

### Fabric Care Labels

Many articles of clothing include a fabric care label. Using the chart below, adjust the cycle and option selections to care for your clothing according to the manufacturer's recommendations.

| Category  | Label   | Directions  |
|---|---|---|
| <br>Washing        |  | Hand wash   |
|   |  | Machine wash, Normal cycle  |
|   |  | Perm Press/Wrinkle Resistant setting (which has a cool down or cold spray before the slower spin) |
|   |  | Gentle/Delicate setting (slow agitation and/or reduced wash time)                                 |
|   |  | Do not wash   |
|   |  | Do not wring  |
| Water Temperature   | ...   | Hot   |
|   | ..  | Warm  |
|   | .   | Cold/Cool   |
| <br>Bleach Symbols |  | Any bleach (when needed)  |
|   |  | Only non-chlorine bleach (when needed)  |
|   |  | Do not bleach   |

## Loading the Washer

- Check and empty pockets. Paper clips, coins, matches, etc. can damage clothing and the washer.
- Close zippers and hooks, and tie drawstrings to prevent snagging or tangling of clothes.
- Pretreat heavily stained areas for best results.
- Brush off heavy soil, dust, and hair from items before washing. Excess dirt or sand can abrade other fabrics and lead to poor wash performance.
- For best performance, load clothes as shown.

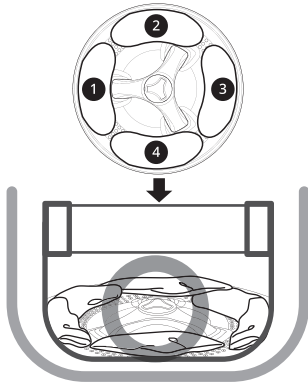

- Do not overload the tub. Clothes should fit loosely in the tub under the maximum fill line ①. Loading clothes over the fill line may result in damage to clothing and the washer.
  - Do not press down on items while stacking them in the tub.
  - Load clothes loosely, and do not overfill the tub. Clothes need room to circulate in order to get clean.



- The washer will not fill or operate with the lid open.

### ⚠ CAUTION

- Do not wash rugs, mats, shoes, pet bedding, or any items other than clothes or sheets, in this washer.
- Press to open the lid. Do not force the lid of the washing machine open. Doing so may damage the machine.

## Bulky Items

- Large, bulky items, such as a blanket, comforter, or bedspread, should be washed individually in the full-size washer.

## Small Items

- Do not wash a single small item. Add enough similar items to the load to prevent an out-of-balance load.

## Adding Cleaning Products

### About Detergent Use

This washer is designed for use with only HE (High-Efficiency) detergents.



- HE detergents produce fewer suds, dissolve more efficiently to improve washing and rinsing performance, and help to keep the interior of the washer clean. Using detergent that is not HE may cause oversudsing and unsatisfactory performance which could result in error codes, cycle failure, and washer damage.
- This machine requires very little detergent. For proper wash performance, always use the dispenser and measuring device provided with the machine.
- The manual dispenser holds a maximum of 2 teaspoons (10 g / 10 cc) of HE detergent. Most normal loads require only 1 teaspoon (5 g / 5 cc) of detergent, or filling the dispenser to the halfway line.

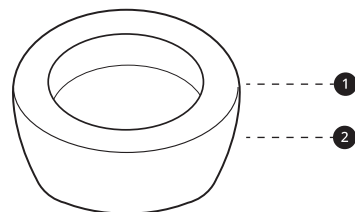

- ① Max load: 2 teaspoons (10 g / 10 cc)
- ② Normal loads: 1 teaspoon (5 g / 5 cc)
- For proper wash performance, always measure detergent using the measuring device provided. For an average load, use half of the recommended maximum. Use less detergent for soft water, light soil, or smaller loads.
- Never use more than the maximum amount of detergent recommended. Using too much detergent can lead to oversudsing, poor rinsing,

detergent buildup in clothing, and residue buildup that can contribute to odors in the washer.

---

### NOTE

- Use extra care when measuring 2X and 3X concentrated detergents because even a small amount of extra detergent can lead to problems.
  - Detergents designated as HE-compatible may not provide optimal results.
- 

## Single-Use Detergent Packs / Gel or Tablet Detergents

Do not use a full detergent pod in the pedestal washer. Using too much detergent may cause oversudsing and unsatisfactory performance. Reduce detergent amount or add an extra rinse if detergent residue is left on fabrics. To add an extra rinse, select the **Rinse** option.

## Adding Detergent and Softener

### Using the Dispenser

- 1 Slide open the drawer.
- 2 Add the detergent and softener into the appropriate compartments.

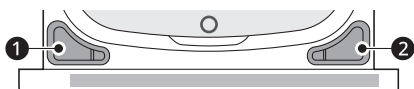

- 1 Liquid detergent compartment
- 2 Liquid fabric softener compartment

---

### NOTE

- Do not fill the detergent and fabric softener dispensers over the maximum fill line. Doing so can cause them to dispense too early, which can stain clothing.
  - Do not use liquid chlorine bleach or powdered bleach in the pedestal washer. To bleach items, use the full-size washer and follow the instructions in the owner's manual included with that machine.
- 

- 3 Gently slide the drawer closed before starting the wash cycle.

---

### NOTE

- Less detergent is required for lightly soiled items. Please use the appropriate amount of detergent in the Mini Washer. If you use too much detergent, excessive bubbles will remain after rinsing.
  - Do not pour liquid detergent and fabric softener directly onto the clothes in the wash drum. Doing so will cause dark staining on the clothes that will be difficult to remove.
  - Do not leave the liquid detergent and liquid fabric softener in the dispenser for more than 1 day. Detergent and softener may harden. Very thick liquids may not dispense completely. Dilute detergents or softeners that are too thick so they flow more easily.
  - Do not open the drawer when water is being supplied during the wash.
  - Do not use solvents such as benzene in the washer.
-

# Control Panel and Wash Cycles

## Control Panel Features

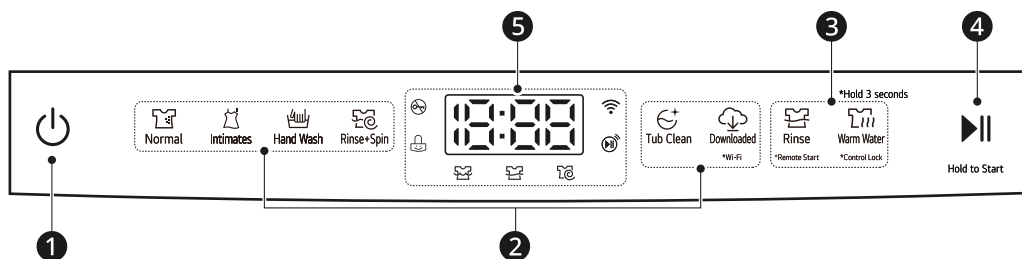

### 1 Power On/Off Button

- Press this button to turn the washer on or off.
- Pressing this button during a cycle will cancel that cycle and any load settings will be lost.
- The drawer will unlock after a brief pause.

### NOTE

- When this button is pressed, the **Normal** cycle is selected by default.

### 2 Cycle Selector Buttons

- Press a button to select the desired cycle.
- Once the desired cycle has been selected, the standard presets will appear in the display.

### NOTE

- To protect your clothing, not all settings are available on all cycle selections.

### 3 Option Buttons

- These buttons allow you to select additional cycle options. Certain buttons also allow you to activate special functions by pressing and holding the button for **3 seconds**.

### 4 Start/Pause Button

- Press and hold this button to start the selected cycle.
- If the washer is running, press this button to pause the cycle without losing the current settings.

### NOTE

- If the **Start/Pause** button is not pressed to start the selected cycle, after a delay the washer automatically turns off and all cycle settings are lost.

### 5 Time and Status Display

- The display shows the settings, estimated time remaining, options, and status messages for the washer.

## Time and Status Display

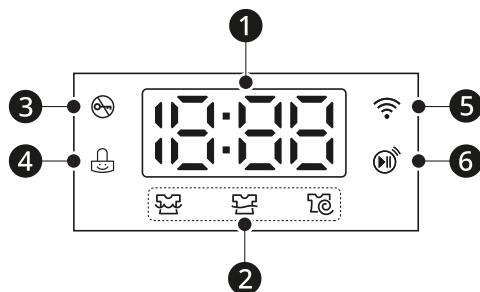

### 1 Estimated Time Remaining

- When a cycle is selected, the default time for that cycle is displayed. This time will change as options are selected.
- If the display shows ---, then the time will be displayed after the load sensing has detected the load size.
- The time shown is only an estimate. This time is based on normal operating conditions. Several external factors (load size, room temperature, incoming water temperature, etc.) can affect the actual time.

### 2 Cycle Status Indicators

- These LEDs will blink when a cycle is selected to indicate which stages will run.
- When a cycle is running, the LED for the active stage will blink, and the LEDs for the remaining stages will remain steady. Once a stage is complete, the LED will turn off. If a cycle is paused, the active stage LED will stop blinking.

### 3 Drawer Lock Indicator

- This indicator lights up when the cycle starts and the drawer is locked.
- The indicator light stays on until the cycle is paused, stopped or has finished.

### 4 Control Lock Indicator

- This indicator lights up when the control panel is locked.
-  and the remaining wash time are displayed, in turn, on the time remaining display.
- When this function is set, all controls are disabled except for the **Power** button.

### 5 Wi-Fi Indicator

- This indicator lights up when the product is connected to a home Wi-Fi network.

### 6 Remote Start Indicator

- This indicator lights up when the **Remote Start** feature is activated.

## Cycle Guide

The wash cycles are designed for specific types of wash loads. Select the cycle that best matches the load contents for maximum wash performance and fabric care.

Press the cycle selector button to select the desired cycle. When you select a wash cycle, the light for the corresponding wash cycle will turn on.

### NOTE

- **Rinse** can be selected for every cycle except for **Tube Clean** in this table.

- **Control Lock** can be selected for every cycle in this table.

| Cycle             | Description   | Estimated Time | Wash Temp.     |                |
|-------------------|---|----------------|----------------|----------------|
|                   |   |                | Warm           | Cold           |
| <b>Normal</b>     | Use this cycle to wash lightly soiled normal items, except delicate fabrics such as wool or silk.<br><br><b>NOTE</b><br>• Pressing the <b>Start/Pause</b> button without selecting a cycle will cause the <b>Normal</b> cycle to begin immediately, using the default settings. | 39 ~ 109       | ● <sup>†</sup> | ●              |
| <b>Intimates</b>  | Use this cycle to wash delicate items such as lingerie or sheer and lacy clothes which could easily be damaged in a normal cycle. This cycle is not for silk items.   | 47 ~ 91        | ● <sup>†</sup> | ●              |
| <b>Hand Wash</b>  | This cycle is for washing shrinkable woolen or hand-washable items requiring delicate care. Only wash woolen items that are labeled machine-washable or hand-washable.  | 47 ~ 91        | ●              | ● <sup>†</sup> |
| <b>Rinse+Spin</b> | Select this cycle to rinse and spin a load separately from a regular cycle.<br>• This can be helpful in preventing fresh stains from setting in fabrics.  | 13 ~ 73        | -              | -              |
| <b>Tub Clean</b>  | This is a special cycle designed to clean the inside of the washer.   | 56             | ● <sup>†</sup> | ●              |
| <b>Downloaded</b> | Connect the washer to the <b>LG ThinQ</b> App and download a new or specialized cycle that isn't included in the standard cycles on the appliance. Time, settings, and options vary by cycle.   | -              | -              | -              |

† Turned on by default.

## Options

Your washer includes additional cycle options to customize cycles to meet your individual needs.

### NOTE

- To protect your garments, not every option is available with every cycle.

## Using Spin Only

Use this option to spin hand washed clothes that may not have been washed in the machine.

- 1 Prepare the clothes and load the drum.
- 2 Press the **Power** button.
  - Do not select a washing cycle and do not add a detergent or softener.
- 3 Select the **Rinse+Spin** cycle and press **Rinse** repeatedly until the display shows  and the Rinse icon is no longer illuminated on the panel.
- 4 Press the **Start/Pause** button.

## Warm Water

This option is selected by default on the **Normal** and **Intimates** cycles. It can be deselected by pressing the **Warm Water** button. The water temperature cannot be set on the **Rinse+Spin** cycle.

## Rinse

This option adds an extra rinse to the selected cycle. Use this option to help ensure the removal of detergent or softener residue from fabrics.

### NOTE

- You cannot select this option with the **Spin Only** option or the **Tub Clean** cycle.

## Control Lock

Use this function to disable the controls. This function can prevent children from changing cycles or operating this washer.

### NOTE

- The function does not lock the door.
- Once this function is set, all buttons are locked except the **Power** button.
- When the controls are locked,  and the remaining time are alternately shown on the display during the wash cycle.
- Turning off the power will not reset this function. You must deactivate this function before you can access any other options and functions.

## Locking the Control Panel

- 1 Slide open the drawer and turn on the power.
- 2 Select a cycle and options and press **Start/Pause** to start the cycle.
- 3 Press and hold the **Warm Water** button for 3 seconds to activate the **Control Lock** function.

## Unlocking the Control Panel

- 1 Slide open the drawer and turn on the power.
- 2 Press and hold the **Warm Water** button for 3 seconds to deactivate this function.
  - When this function is deactivated, a chime will sound and the remaining time for the current cycle will reappear on the display.

## Setting

### Adjusting Volume of Alert Sounds

Use this function to adjust the volume of the button sounds and the end-of-cycle alert.

- 1 Slide open the drawer and turn on the power.
- 2 Press and hold the **Hand Wash** button for 3 seconds to adjust the volume.
  - Each time you press and hold the button, the volume changes. The setting is shown in the display: 1, 2, 3, 4 or OFF.
  - The default volume is 4 (loudest).



- To turn the sounds off completely, repeatedly press and hold the button until OFF appears in the status display.

# SMART FUNCTIONS

## Using LG ThinQ Application

### LG ThinQ Application Features

For products that contain a Wireless LAN module

- **Remote Start**
  - Control the appliance remotely from the **LG ThinQ** application.
- **Downloaded**
  - Download new and specialized cycles that are not included in the standard cycles on the appliance.
- **Tub Clean Coach**
  - Find out how many cycles remain before it is time to run the **Tub Clean** cycle.
- **Energy Monitoring**
  - This function displays the energy consumption of recently used cycles and the monthly average.
- **Smart Diagnosis™**
  - This function provides useful information for diagnosing and solving issues with the appliance based on the pattern of use.
- **Push Alerts**
  - When the cycle is complete or the appliance has problems, you will receive a push message.
- **Settings**
  - Set various options on the appliance and in the application.

### NOTE

- If you change your wireless router, Internet service provider, or password, delete the connected appliance from the **LG ThinQ** application and connect it again.
- This information is current at the time of publication. The application is subject to change for product improvement purposes without notice to users.

## Installing LG ThinQ App and Connecting an LG Appliance

### Models with QR Code

Scan the QR code attached to the product using the camera or a QR code reader app on your smartphone.



### Models without QR Code

- 1** Search for and install the **LG ThinQ** app from the Google Play Store or Apple App Store on a smartphone.
- 2** Run the **LG ThinQ** app and sign in with your existing account or create an LG account to sign in.
- 3** Touch the add (+) button on the **LG ThinQ** app to connect your LG appliance. Follow the instructions in the app to complete the process.

### NOTE

- You may be asked to provide a password to connect to the LG network (not your home network) during the Wi-Fi setup. The password is the last 4 characters of the network name, repeated twice, with no spaces. For example, if the network name appears as LG\_XXXX\_8b92, then you would enter 8b928b92 as your password. The password is case sensitive and the last 4 characters are unique to your appliance.

- To verify the Wi-Fi connection, check that the  icon on the control panel is lit.
- The appliance supports 2.4 GHz Wi-Fi networks only. To check your network frequency, contact your Internet service provider or refer to your wireless router manual.
- **LG ThinQ** is not responsible for any network connection problems or any faults, malfunctions, or errors caused by network connection.
- If the appliance is having trouble connecting to the Wi-Fi network, it may be too far from the router. Purchase a Wi-Fi repeater (range extender) to improve the Wi-Fi signal strength.
- The Wi-Fi connection may not connect or may be interrupted because of the home network environment.
- The network connection may not work properly depending on the Internet service provider.
- The surrounding wireless environment can make the wireless network service run slowly.
- If the appliance cannot be registered due to problems with the wireless signal transmission, unplug the appliance and wait about a minute before trying again.
- If the firewall on your wireless router is enabled, disable the firewall or add an exception to it.
- The wireless network name (SSID) should be a combination of English letters and numbers. (Do not use special characters.)
- Smartphone user interface (UI) may vary depending on the mobile operating system (OS) and the manufacturer.
- If the security protocol of the router is set to **WEP**, network setup may fail. Change the security protocol (**WPA2** is recommended) and connect the product again.

## Using the Appliance Remotely

### Remote Start

Use a smartphone to control your appliance remotely. You can also monitor your cycle operation so you know how much time is left in the cycle.

### Using Remote Start

- 1 Put the clothes into the tub.
  - Add detergent and, if desired, fabric softener to the appropriate areas of the dispenser.

- 2 Press the **Power** button.
- 3 Press and hold the **Rinse** button for 3 seconds to enable the remote control function.
- 4 Start a cycle from the **LG ThinQ** application on your smartphone.

### NOTE

- Once this function is enabled, you can only start a cycle from the **LG ThinQ** smartphone application. If the cycle is not started, the appliance will wait to start the cycle until it is turned off remotely from the application or this function is disabled.
- If the door has been opened, you cannot start a cycle remotely.

### Disabling Remote Start Manually

When this function is activated, press and hold the **Rinse** button for 3 seconds.

## Radio Equipment Specifications

|  |                 |
|--|-----------------|
| <b>Wireless LAN Frequency Range</b>    | 2412 - 2462 MHz |
| <b>Wireless LAN Output Power (Max)</b> | < 30 dBm        |
| <b>Bluetooth Frequency Range</b>       | 2402 - 2480 MHz |
| <b>Bluetooth Output Power (Max)</b>    | < 30 dBm        |

## FCC Notice

The following notice covers the transmitter module contained in this product.

This equipment has been tested and found to comply with the limits for a Class B digital device, pursuant to Part 15 of the FCC Rules. These limits are designed to provide reasonable protection against harmful interference in a residential installation. This equipment generates, uses, and can radiate radio frequency energy and, if not installed and used in accordance with the instructions, may cause harmful interference to radio communications. However, there is no guarantee that interference will not occur in a particular installation. If this equipment does cause harmful interference to radio or television reception, which can be determined by turning the

equipment off and on, the user is encouraged to try to correct the interference by one or more of the following measures:

- Reorient or relocate the receiving antenna.
- Increase the separation between the equipment and the receiver.
- Connect the equipment to an outlet on a circuit different from that to which the receiver is connected.
- Consult the dealer or an experienced radio/TV technician for help.

This device complies with part 15 of the FCC Rules. Operation is subject to the following two conditions:

(1) This device may not cause harmful interference and

(2) This device must accept any interference received, including interference that may cause undesired operation.

Any changes or modifications in construction of this device which are not expressly approved by the party responsible for compliance could void the user's authority to operate the equipment.

### Industry Canada Statement

This device contains licence-exempt transmitter(s)/ receiver(s) that comply with Innovation, Science and Economic Development Canada's licence-exempt RSS(s). Operation is subject to the following two conditions:

(1) This device may not cause interference.

(2) This device must accept any interference, including interference that may cause undesired operation of the device.

### IC Radiation Exposure Statement

This equipment complies with IC radiation exposure limits set forth for an uncontrolled environment.

This equipment should be installed and operated with a minimum distance of 20 cm (7.8 inches) between the antenna and your body.

---

#### NOTE

- THE MANUFACTURER IS NOT RESPONSIBLE FOR ANY RADIO OR TV INTERFERENCE CAUSED BY UNAUTHORIZED MODIFICATIONS TO THIS EQUIPMENT. SUCH MODIFICATIONS COULD VOID THE USER'S AUTHORITY TO OPERATE THE EQUIPMENT.
- 

### Open Source Software Notice Information

To obtain the source code that is contained in this product, under GPL, LGPL, MPL, and other open source licenses that have the obligation to disclose source code, and to access all referred license terms, copyright notices and other relevant documents, please visit <https://opensource.lge.com>.

LG Electronics will also provide open source code to you on CD-ROM for a charge covering the cost of performing such distribution (such as the cost of media, shipping, and handling) upon email request to [opensource@lge.com](mailto:opensource@lge.com).

This offer is valid to anyone in receipt of this information for a period of three years after our last shipment of this product.

### Smart Diagnosis™ Function

Use this feature to help you diagnose and solve problems with your appliance.

---

#### NOTE

- For reasons not attributable to LGE's negligence, the service may not operate due to external factors such as, but not limited to, Wi-Fi unavailability, Wi-Fi disconnection, local app store policy, or app unavailability.
  - The feature may be subject to change without prior notice and may have a different form depending on where you are located.
- 

### Using LG ThinQ to Diagnose Issues

If you experience a problem with your Wi-Fi equipped appliance, it can transmit troubleshooting data to a smartphone using the **LG ThinQ** application.

- Launch the **LG ThinQ** application and select the **Smart Diagnosis™** feature in the menu. Follow the instructions provided in the **LG ThinQ** application.

### Using Audible Diagnosis to Diagnose Issues

Follow the instructions below to use the audible diagnosis method.

- Launch the **LG ThinQ** application and select the **Smart Diagnosis** feature in the menu. Follow the instructions for audible diagnosis provided in the **LG ThinQ** application.

- 1** Press the **Power** button to turn on the appliance.
  - Do not press any other buttons.
- 2** Place the mouthpiece of your smartphone close to the **Power** button.

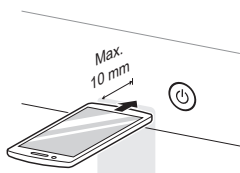

- 3** Press and hold the **Rinse+Spin** button for 3 seconds or longer while holding the smartphone mouthpiece to the **Power** button until the data transfer is complete.
  - Keep the smartphone in place until the data transfer has finished. Time remaining for data transfer is displayed.
- 4** After the data transfer is complete, the diagnosis will be displayed in the application.

---

**NOTE**

- For best results, do not move the smartphone while the tones are being transmitted.
-

# MAINTENANCE

## ⚠ WARNING

- To reduce the risk of fire, electric shock, or injury to persons, read this entire owner's manual, including the **SAFETY INSTRUCTIONS**, before operating this appliance.
- Unplug the appliance before cleaning to avoid the risk of electric shock. Failure to follow this warning can cause serious injury, fire, electric shock, or death.
- Do not use volatile substances (benzene, paint thinner, alcohol, acetone, etc.), abrasive cleaners, or detergents with strong chemical components when cleaning the appliance. Doing so may cause discoloration or damage to the appliance, or may cause a fire.
- Certain internal parts are intentionally not grounded and may present a risk of electric shock only during servicing. Service personnel - Do not contact the following parts while the appliance is energized: pump, valve, motor, control board.

## Regular Cleaning

### Care after Wash

After the cycle is finished, wipe the lid and the inside of the lid seal to remove any moisture.

- Wipe the body of the washer with a dry cloth to remove any moisture.
- Leave the lid open to dry the tub interior.

## ⚠ WARNING

- Make sure children and pets do not climb onto the drawer. Engage the **Child Lock** feature if needed to prevent children from accidentally starting a wash cycle.

## Cleaning the Exterior

Proper care of your washer can extend its life.

### Exterior:

- Immediately wipe off any spills.
- Wipe with a damp cloth.
- Do not touch the surface or the display with sharp objects.

## Cleaning Detergent and Softener Dispensers

Clean the dispensers periodically to prevent detergent or softener scale from building up.

- 1 Slide open the drawer.

- 2 Insert your finger under the top lip of the dispenser and pull to remove the dispenser cover.

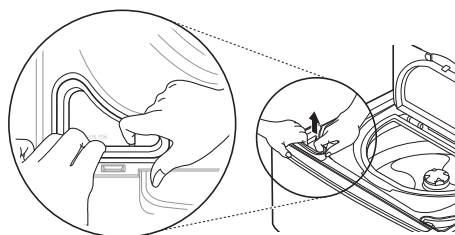

- 3 Clean the dispenser cover and the inside of the dispenser using a toothbrush or other soft-bristle brush.
- 4 Wipe the inside of the dispenser dry.
- 5 After cleaning, reassemble the dispenser cover and gently press down until it clicks into place.

## Periodic Maintenance

- Use a towel or soft cloth to wipe around the washer lid opening and lid glass.
- Always remove items from the washer as soon as the cycle is complete. Leaving damp items in the washer can cause wrinkling, color transfer, and odor.

## Cleaning the Drum

Over time, residue may build up in the drum, leading to mildew or a musty odor. Run the **Tub**

Clean cycle **monthly** to remove residue and prevent odor.

**NOTE**

- Make sure to run the **Tub Clean** cycle only when the drum is empty. Never load laundry while using this cycle. The laundry may be damaged or contaminated with cleaning products.
- Run the cycle more often under heavy use conditions or if odor is already present.
- If mildew or musty smell already exists, run this cycle once a week for three consecutive weeks.

**1** Remove any clothing from the drum.

**2** Add cleaning agents.

| Cleaner                | Instructions   |
|------------------------|--|
| Drum cleaner           | Add to detergent dispenser or pour it into the drum.   |
| Lime scale remover     |  |
| Powdered cleaner       |  |
| Liquid chlorine bleach | Dilute 1/4 cup of liquid chlorine bleach in 1 quart of water and pour the mixture into the drum. |
| Cleaning tablets       | Place directly into the washer drum.   |

- For other drum cleaning products, follow the cleaner manufacturer's instructions and recommendations.
- Do not use any more than 1/4 cup of liquid bleach. Do not let bleach sit in the tub for a long period before running the **Tub Clean** cycle.
- Do not exceed the maximum fill line when adding powdered cleaners. Powdered cleaners may remain in the drum after cleaning.

**3** Close the lid and drawer and press the **Power** button.

**4** Select the **Tub Clean** cycle and press the **Start/Pause** button to begin the cycle.

**5** After the cycle ends, open the lid and allow the drum interior to dry completely.

**⚠ WARNING**

- Make sure children and pets do not climb onto the drawer. Engage the **Control Lock** feature if needed to prevent children from accidentally starting a wash cycle.

**NOTE**

- If you use a descaler or drum cleaner during the **Tub Clean** cycle, use the **Rinse+Spin** option to rinse the washer drum before running your next wash cycle.

**Automatic Alert for Tub Clean**

When the power is on and the **EcL** message blinks on the display, it means the washer drum needs cleaning. Use the **Tub Clean** cycle to clean the washer drum. The frequency of the automatic alert's appearance depends on how often the washer is used. However, the message will generally appear every one to two months.

**Removing Mineral Buildup**

In areas with hard water, mineral scale can form on internal components of the washer. Periodically clean the mineral buildup on the internal components to extend the lifespan of the washer. Use of a water softener is recommended in areas with hard water.

- Use a descaler to remove visible mineral buildup on the washer drum.
- After descaling, always run the **Tub Clean** cycle before washing clothing.
- Mineral scale and other spots may be removed from the stainless steel drum using a soft cloth soaked in stainless steel cleaner.
- Do not use steel wool or abrasive cleaners.

**Leaving the Lid Open**

After you finish using the washer, leave the lid and drawer open overnight to allow air to circulate and dry the drum. This helps prevent odors.

**⚠ WARNING**

- Do not allow children or pets to play on, in or with the appliance. Close supervision is necessary when the appliance is used near children or pets.

## Cleaning the Water Inlet Filters

If the washer does not fill properly, an error message will appear on the display. The inlet valve filter screens could be clogged by hard water scale, sediment in the water supply, or other debris.

### ⚠ WARNING

- The inlet screens protect the delicate parts of the inlet valve from being damaged by particles that could enter the valves with the water supply. Operating the washer with these filters removed could cause a valve to open continuously, resulting in flooding and/or property damage.

### ⚠ CAUTION

- Do not use the washer without the inlet filters. Doing so will cause leaks and malfunction.
- If you use the washer in an area with hard water, the inlet filter may clog due to lime buildup and require more frequent cleaning.

- 1 Turn off the washer, and unplug the power cord.
- 2 Turn off hot and cold water faucets.
- 3 Unscrew the hot and cold water hoses from the back of the washer.
- 4 Remove the filters from the water valves carefully.
  - Use pliers to pull out the filters from the water valves.

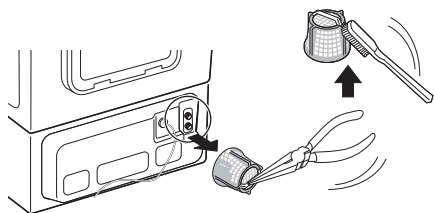

- 5 Remove foreign objects and soak the filters in white vinegar or a lime scale remover.
  - If using a lime scale remover, follow the manufacturer's instructions. Be careful not to damage the filters while cleaning them.
- 6 Rinse filters thoroughly and press them back into place.

- 7 Flush then reattach the water hoses.
  - Before reattaching the water inlet hoses, flush them by running several gallons of water through them into a bucket or drain, preferably with the faucets wide open for maximum flow.

### NOTE

- An I E error message may blink on the display when the water pressure is low or an inlet filter is clogged with dirt. Clean the inlet filter.

## Storing the Washer

If the washer will not be used for an extended period of time and is in an area that could be exposed to freezing temperatures, follow these steps to protect the washer from damage.

### NOTE

- Make sure the drum is empty before following these steps.

- 1 Turn off the washer, and unplug the power cord.
- 2 Turn off the water faucets.
- 3 Disconnect the water inlet hoses. Drain any water from the hoses.

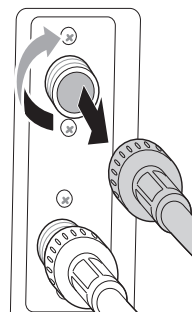

- 4 Plug the power cord into a properly grounded electrical outlet.
- 5 Add 1/4 gallon of nontoxic recreational vehicle (RV) antifreeze to the empty drum and close the lid.
  - Never use automotive antifreeze.



- 6** Turn on the washer and select the **Spin Only** option.
- 7** Press the **Start/Pause** button to start the drain pump for **1 minute**.
  - This will expel some of the antifreeze, leaving enough to protect the washer from damage.
- 8** Turn off the washer and unplug the power cord.
- 9** Dry the drum interior with a soft cloth, and close the lid.
- 10** Store the washer in an upright position.
- 11** Drain any water in dispenser compartments and let them dry.
- 12** To remove the antifreeze from the washer after storage, run the **Rinse+Spin** cycle using detergent.
  - Do not add laundry to this cycle.

# TROUBLESHOOTING

## Before Calling for Service

The washer is equipped with an automatic error-monitoring system to detect and diagnose problems at an early stage. If the washer does not function properly or does not function at all, check the following before you call for service.

### FAQs

**Q: Can the pedestal washer and the front-loading washer be run at the same time?**

**A:** Yes. The pedestal washer is designed to operate simultaneously under LG manufactured front-loading washers produced after 2009. It is not designed for operation under LG top-loading washers, LG dryers, non-LG manufactured appliances, or as a standalone unit. For more information regarding compatibility, visit the LG website at [www.lg.com](http://www.lg.com).

**Q: How much clothing can be loaded in the pedestal washer?**

**A:** The drum is designed to hold a maximum of 4 lb. (One thick bath towel weighs about one pound when dry.) Do not overload the washer drum. The clothing should fit loosely into the drum and the lid should close easily.

**Q: How much detergent, softener, or bleach should be used per load? How/when is it added to the machine?**

**A: Detergent :**

- The pedestal washer requires very little detergent. Most normal loads only require 1 tsp (5 g) of HE detergent. Use a maximum of 2 tsp (10 g) of HE detergent. Do not use a full detergent pod.
- Pour the detergent in the detergent dispenser (some models) or the manual measuring device/dispenser provided with the machine. Place the dispenser in the drum with the clothing before beginning the cycle.
- If the dispenser is missing, place the 1–2 tsp. (5–10 g) of detergent directly into the drum.
- For more information, see **Adding Detergent**.

**Fabric Softener :**

- Use 1/4 the amount recommended by the manufacturer for a normal load. Use the dispenser provided with the machine. For instructions, see **Adding Fabric Softeners**.

**Bleach :**

- Do not use liquid or powdered bleach to launder items in the pedestal washer. To safely and effectively launder items using bleach, use the front-loading washer.

**Q: Can I slide the drawer out while the cycle is running?**

**A:** No. The drawer locks for safety during operation. Pause the cycle to open the drawer.

**Q: What if I want to add an item after I've started the cycle?**

**A:** Press the **Start/Pause** button to pause the cycle. After the drawer unlocks, add the item and press **Start/Pause** to restart the cycle. Wash performance may be affected if the item is added after the first few minutes.

## Error Messages

| Problem  | Possible Cause & Solution  |
|--|--|
| <b>dE 1, dE2</b><br><b>DRAWER/LID OPEN ERROR</b> | <b>The drawer or the lid is not secured.</b> <ul style="list-style-type: none"> <li>Close and secure the drawer or the lid. If the message keeps appearing, unplug the power cord and call for service.</li> </ul>   |
| <b>dE4</b><br><b>DRAWER UNLOCK ERROR</b>         | <b>The drawer is not secured.</b> <ul style="list-style-type: none"> <li>Check for objects around the door and door seal. If the message keeps appearing, unplug the power cord and call for service.</li> </ul>   |
| <b>I E</b><br><b>INLET ERROR</b>                 | <b>Water supply faucets are not fully open.</b> <ul style="list-style-type: none"> <li>Make sure that the water faucets are fully open.</li> </ul>   |
|  | <b>Water inlet hoses are kinked, pinched, or crushed.</b> <ul style="list-style-type: none"> <li>Make sure that the hoses are not kinked, pinched or crushed behind or under the washer. Be careful when moving the washer during cleaning or maintenance.</li> </ul>  |
|  | <b>Water inlet filters are clogged.</b> <ul style="list-style-type: none"> <li>Clean the inlet filters. See <b>MAINTENANCE</b>.</li> </ul>   |
|  | <b>Water supply pressure to faucet or house is too low.</b> <ul style="list-style-type: none"> <li>Check another faucet in the house to make sure that household water pressure is adequate and flow is not restricted.</li> <li>Disconnect the water inlet hoses from the washer and run a few gallons of water through the hoses to flush out any dirt.</li> <li>If flow is too low, contact a plumber to have the water supply lines repaired.</li> </ul> |
|  | <b>Water supply connected with leak-limiting hoses.</b> <ul style="list-style-type: none"> <li>The use of hoses designed to limit leaks is not recommended. Leak limiting hoses can trip falsely and prevent the washer from filling.</li> </ul>   |
| <b>OE</b><br><b>WATER OUTLET ERROR</b>           | <b>Drain hose is kinked, pinched, or clogged.</b> <ul style="list-style-type: none"> <li>Make sure that the drain hose is free of clogs or kinks and is not pinched behind or under the washer.</li> </ul>   |
|  | <b>The end of the drain hose is more than 96 inches (2.4 m) above the bottom of the washer.</b> <ul style="list-style-type: none"> <li>Move the end of the drain hose so that it is lower than <b>96 inches (2.4 m)</b>.</li> </ul>  |
| <b>UE</b><br><b>UNBALANCE ERROR</b>              | <b>The load is too small.</b> <ul style="list-style-type: none"> <li>Add additional items to allow the washer to balance the load.</li> </ul>  |
|  | <b>Heavy articles are mixed with lighter items.</b> <ul style="list-style-type: none"> <li>Always try to wash articles of somewhat similar weight to allow the washer to evenly distribute the weight of the load for spinning.</li> </ul>   |
|  | <b>The load is out of balance.</b> <ul style="list-style-type: none"> <li>Manually redistribute the load if articles have become tangled, preventing the automatic rebalancing from working properly.</li> </ul>   |
| <b>EE</b><br><b>TEMPERATURE SENSOR ERROR</b>     | <b>Control error.</b> <ul style="list-style-type: none"> <li>Unplug the washer and wait 60 minutes. Reconnect power and try again.</li> <li>If the error code is still displayed, call for service</li> </ul>  |
| <b>FE</b><br><b>OVERFLOW ERROR</b>               | <b>Water level is too high due to a faulty water valve.</b> <ul style="list-style-type: none"> <li>Close the water faucets, unplug the washer, and call for service.</li> </ul>  |
| <b>PE</b><br><b>PRESSURE SENSOR ERROR</b>        | <b>The water level sensor is not working correctly.</b> <ul style="list-style-type: none"> <li>Close the water faucets, unplug the washer, and call for service.</li> </ul>  |

| Problem                               | Possible Cause & Solution  |
|---------------------------------------|--|
| LE<br>MOTOR LOCKED<br>ERROR           | <b>A motor error has occurred.</b> <ul style="list-style-type: none"> <li>Allow the washer to stand for 30 minutes and then restart the cycle.</li> <li>If the error code is still displayed, call for service.</li> </ul>   |
| PF<br>POWER FAILURE                   | <b>Power failure or inadequate electrical service may have occurred during operation.</b> <ul style="list-style-type: none"> <li>Press the <b>Start/Pause</b> button to restart the cycle.</li> </ul>  |
| FF<br>FROZEN ERROR                    | <b>Inlet hose, drain hose or drain pump is frozen.</b> <ul style="list-style-type: none"> <li>See <b>Care in Cold Climates</b> in the front-loading washer manual.</li> </ul>  |
| CL<br>CONTROL LOCK<br>FUNCTION        | <b>The Control Lock function is on to prevent anyone from changing cycles or operating the washer.</b> <ul style="list-style-type: none"> <li>Turn off the <b>Control Lock</b> function in the control panel. See <b>Control Lock</b> under <b>Options</b>.</li> </ul> |
| EcL<br>TUB CLEAN ALARM                | <b>It is time to run the Tub Clean cycle.</b> <ul style="list-style-type: none"> <li>This is not an error code. It indicates that the <b>Tub Clean</b> cycle is running or needs to be run to clean the washer drum.</li> </ul>  |
| E7<br>STACKING ERROR                  | <b>Pedestal washer is being operated without a full-size washer.</b> <ul style="list-style-type: none"> <li>The pedestal washer will not operate as a standalone unit. It must be stacked under a full-size LG appliance.</li> </ul>                                   |
|                                       | <b>Stacking switch is not working properly.</b> <ul style="list-style-type: none"> <li>The stacking switch will not operate properly if the unit is stacked under a non-LG appliance, or an LG appliance manufactured before 2009.</li> </ul>                          |
| P5<br>VOLTAGE<br>ABNORMALITY<br>ERROR | <b>Abnormal voltage detected.</b> <ul style="list-style-type: none"> <li>Unplug the power plug for a few minutes and plug it back in. If the error recurs, call for service.</li> </ul>  |

## Noises

| Problem   | Possible Cause & Solution  |
|---|--|
| Clicking  | <b>Lid lock sounds when the lid locks or unlocks.</b> <ul style="list-style-type: none"> <li>Normal operation</li> </ul>   |
| Spraying or hissing   | <b>Water spraying or circulating during the cycle</b> <ul style="list-style-type: none"> <li>Normal operation</li> </ul>   |
| Humming or Gurgling   | <b>Drain pump is pumping water from the washer at times during a cycle.</b> <ul style="list-style-type: none"> <li>Normal operation</li> </ul>   |
| Water sloshing  | <b>A liquid in the balance ring around the pulsator helps the basket spin smoothly.</b> <ul style="list-style-type: none"> <li>Normal operation</li> </ul>   |
| Water being added after the washer has already begun to operate | <b>The washer adapts to the load size and type to add more water to the cycle as needed.</b> <ul style="list-style-type: none"> <li>Normal operation</li> </ul>  |
|   | <b>The wash load may be unbalanced. If the washer senses that the load is unbalanced, it will stop and refill to redistribute the load.</b> <ul style="list-style-type: none"> <li>Normal operation</li> </ul> |
|   | <b>The washer may be diluting laundry additives to add to the wash load.</b> <ul style="list-style-type: none"> <li>Normal operation</li> </ul>  |

| Problem  | Possible Cause & Solution   |
|--|---|
| <b>Rattling and clanking noise</b>                 | <p><b>Foreign objects, such as keys, coins, or safety pins may be in the drum.</b></p> <ul style="list-style-type: none"> <li>Stop the appliance and check the drum for foreign objects. If the noise continues after the appliance is restarted, call for service.</li> </ul>  |
| <b>Thumping sound</b>                              | <p><b>Heavy clothes may produce a thumping sound. This is usually normal.</b></p> <ul style="list-style-type: none"> <li>If the sound continues, the appliance is probably out of balance. Stop and redistribute the clothes.</li> </ul>  |
|  | <p><b>The clothes may be out of balance.</b></p> <ul style="list-style-type: none"> <li>Pause the cycle and redistribute the clothes after the lid unlocks.</li> </ul>  |
| <b>Vibrating noise</b>                             | <p><b>Packaging materials are not removed.</b></p> <ul style="list-style-type: none"> <li>Remove packaging materials.</li> </ul>  |
|  | <p><b>The clothes may be unevenly distributed in the drum.</b></p> <ul style="list-style-type: none"> <li>Pause the cycle and redistribute the clothes after the lid unlocks.</li> </ul>  |
|  | <p><b>Not all levelling feet are resting firmly and evenly on the floor.</b></p> <ul style="list-style-type: none"> <li>See the <b>Levelling the Appliance</b> instruction to adjust the levelling of the appliance.</li> </ul>   |
|  | <p><b>Floor not rigid enough.</b></p> <ul style="list-style-type: none"> <li>Check if the floor is solid and does not flex. See <b>Choosing the Proper Location</b> to select the proper location.</li> </ul>   |
| <b>Washer chimes repeatedly before final rinse</b> | <p><b>This is not an error. This is an alert to allow the addition of liquid fabric softener before the final rinse.</b></p> <ul style="list-style-type: none"> <li>See <b>Adding Detergent and Softener</b> for instructions on adding liquid fabric softener to the load.</li> </ul> <p>To disable or enable the fabric softener alert, press and hold <b>Warm Water</b> and <b>Extra Rinse</b> at the same time for three seconds.</p> |

## Operation

| Problem              | Possible Cause & Solution  |
|----------------------|--|
| <b>Water Leaking</b> | <p><b>Inlet hose connection is loose at faucet, washer, or Y-connector.</b></p> <ul style="list-style-type: none"> <li>Check hoses and Y-connectors for leaks, cracks and splits.</li> <li>Check and tighten hose connections.</li> </ul>  |
|                      | <p><b>House drain pipes are clogged.</b></p> <ul style="list-style-type: none"> <li>The washer pumps out water very rapidly. Check for water backing up out of the drain pipe during drain. If water is seen coming out of the drain, check for proper drain hose installation and check for restrictions in the drain.</li> <li>Contact a plumber to repair the drain pipe.</li> </ul>  |
|                      | <p><b>Drain hose has come out of the drain connector or is not inserted far enough.</b></p> <ul style="list-style-type: none"> <li>Tie the drain hose to the inlet hose or standpipe to prevent it from coming out during draining.</li> <li>For smaller drain pipes, insert the drain hose into the pipe as far as the drain hose flange. For larger drain pipes, insert the drain hose into the pipe 1 - 2 inches past the flange.</li> </ul>        |
|                      | <p><b>Oversudsing of detergent</b></p> <ul style="list-style-type: none"> <li>Oversudsing may create leaks, and may be caused by the type and amount of detergent used. High-Efficiency detergent is the only detergent recommended.</li> <li>Always reduce the amount of detergent if the load is small or lightly soiled, or if your water is very soft.</li> <li>Never use more than the maximum amount shown in the dispenser provided.</li> </ul> |

| Problem                                      | Possible Cause & Solution  |
|--|--|
| <b>Excessive sudsing</b>                     | <p><b>Too much detergent or incorrect detergent</b></p> <ul style="list-style-type: none"> <li>• HE detergents are formulated specifically for HE (High-Efficiency) washers and contain suds reducing agents. Only use detergent with the HE (High-Efficiency) logo.</li> <li>• For detergent quantities refer to <b>About Detergent Use</b> in <b>OPERATION</b>. If sudsing or detergent residue continues to be an issue, add an extra rinse.</li> </ul>   |
| <b>Washer will not turn on.</b>              | <p><b>Power cord is not properly plugged in.</b></p> <ul style="list-style-type: none"> <li>• Make sure that the plug is plugged securely into a grounded, 3-prong, 120-VAC, 60 Hz outlet.</li> </ul> <p><b>House fuse is blown, circuit breaker has tripped, or power outage has occurred.</b></p> <ul style="list-style-type: none"> <li>• Reset circuit breaker or replace fuse. Do not increase fuse capacity. If the problem is a circuit overload, have it corrected by a qualified election.</li> </ul> <hr/> <p><b>NOTE</b></p> <ul style="list-style-type: none"> <li>• If the washer stopped during a cycle due to a loss of power, the washer will resume the cycle where it stopped when the power is restored.</li> </ul>   |
| <b>Wash cycle time is longer than usual.</b> | <p><b>The washer automatically adjusts the wash time for the amount of laundry, water pressure and other operating conditions.</b></p> <ul style="list-style-type: none"> <li>• This is normal. The washer adjusts the cycle time automatically to provide optimal results for the selected cycle. The time remaining shown in the display is only an estimate. The actual time may vary.</li> </ul>   |
| <b>Washer will not operate.</b>              | <p><b>Control panel has powered off due to inactivity.</b></p> <ul style="list-style-type: none"> <li>• This is normal. Press the <b>Power</b> button to turn on the washer.</li> </ul> <p><b>Washer is unplugged.</b></p> <ul style="list-style-type: none"> <li>• Make sure that the power cord is plugged securely into an electrical outlet.</li> </ul> <p><b>Water supply is turned off.</b></p> <ul style="list-style-type: none"> <li>• Turn both hot and cold faucets fully on.</li> </ul> <p><b>Controls are not set properly.</b></p> <ul style="list-style-type: none"> <li>• Make sure that the cycle was set correctly, close the door and press the <b>Start/Pause</b> button to start the wash cycle.</li> </ul> <p><b>Lid or drawer is open.</b></p> <ul style="list-style-type: none"> <li>• Close the lid and drawer and make sure that nothing is caught under the lid preventing it from closing completely.</li> </ul> <p><b>Circuit breaker/fuse is tripped/blown.</b></p> <ul style="list-style-type: none"> <li>• Check house circuit breakers/fuses. Replace the fuses or reset the breaker. The washer should be on a dedicated branch circuit.</li> </ul> <p><b>Control needs to be reset.</b></p> <ul style="list-style-type: none"> <li>• Press the <b>Power</b> button. Then reselect the desired cycle and press the <b>Start/Pause</b> button.</li> </ul> <p><b>Start/Pause button was not pressed after the cycle was set.</b></p> <ul style="list-style-type: none"> <li>• Press the <b>Power</b> button. Then reselect the desired cycle and press the <b>Start/Pause</b> button. The appliance is turned off if the <b>Start/Pause</b> button is not pressed within a certain time.</li> </ul> <p><b>Extremely low water pressure.</b></p> <ul style="list-style-type: none"> <li>• Check another faucet in the house to make sure that household water pressure is adequate.</li> </ul> <p><b>Washer is too cold.</b></p> <ul style="list-style-type: none"> <li>• If the washer has been exposed to temperatures below freezing for an extended period of time, allow it to warm up before pressing the <b>Power</b> button. Otherwise, the display will not come on.</li> </ul> |

| Problem                                | Possible Cause & Solution  |
|--|--|
| <b>Washer is not filling properly.</b> | <b>Filter is clogged.</b> <ul style="list-style-type: none"> <li>Make sure that the inlet filters on the fill valves are not clogged. Refer to <b>Cleaning the Water Inlet Filters</b> in <b>MAINTENANCE</b>.</li> </ul>     |
|  | <b>Inlet hoses may be kinked.</b> <ul style="list-style-type: none"> <li>Check that the inlet hoses are not kinked or clogged.</li> </ul>  |
|  | <b>Energy efficiency</b> <ul style="list-style-type: none"> <li>This is a High-Efficiency (HE) washer. As a result, the water level settings for this washer may be different than for a conventional washer.</li> </ul>     |
|  | <b>Insufficient water supply</b> <ul style="list-style-type: none"> <li>Make sure that both the hot and cold water faucets are turned on all the way.</li> </ul>   |
|  | <b>Lid and drawer is open.</b> <ul style="list-style-type: none"> <li>Close the lid and drawer and make sure that nothing is caught under the lid preventing it from closing completely.</li> </ul>                          |
|  | <b>Water level is too low.</b> <ul style="list-style-type: none"> <li>The water will not normally cover the clothes. The fill level is optimized for the wash motion to achieve the best wash performance.</li> </ul>        |
| <b>Washer will not drain water.</b>    | <b>Drain hose is kinked, pinched, or clogged.</b> <ul style="list-style-type: none"> <li>Make sure that the drain hose is free of clogs or kinks and is not pinched behind or under the washer.</li> </ul>                   |
|  | <b>The end of the drain hose is more than 96 inches (2.4 m) above the bottom of the washer.</b> <ul style="list-style-type: none"> <li>Move the end of the drain hose so that it is lower than 96 inches (2.4 m).</li> </ul> |

## Performance

| Problem                   | Possible Cause & Solution  |
|---------------------------|--|
| <b>Wrinkling</b>          | <b>Washer is not unloaded promptly.</b> <ul style="list-style-type: none"> <li>Always remove items from the washer as soon as the cycle is complete.</li> </ul>  |
|                           | <b>Washer is overloaded.</b> <ul style="list-style-type: none"> <li>The washer can be fully loaded, but the drum should not be tightly packed with items. The lid of the washer should close easily.</li> </ul>  |
|                           | <b>Hot and cold water inlet hoses are reversed.</b> <ul style="list-style-type: none"> <li>A hot water rinse can set wrinkles in garments. Check the inlet hose connectors.</li> </ul>   |
| <b>Staining</b>           | <b>Softener was added directly to the wash load in the drum.</b> <ul style="list-style-type: none"> <li>Always use the dispensers to prevent staining.</li> </ul>  |
|                           | <b>Washer was not unloaded promptly.</b> <ul style="list-style-type: none"> <li>Always remove items from the washer as soon as possible after the cycle is completed.</li> </ul>   |
|                           | <b>Clothes were not properly sorted.</b> <ul style="list-style-type: none"> <li>Always wash dark colors separately from light colors and whites to prevent discoloration.</li> <li>Never wash heavily soiled items with lightly soiled items.</li> </ul> |
| <b>Poor stain removal</b> | <b>Heavily soiled load.</b> <ul style="list-style-type: none"> <li>Heavier soils and tougher stains may require the extra cleaning power of the Main Washer.</li> </ul>  |

| Problem                             | Possible Cause & Solution  |
|-------------------------------------|--|
| Poor stain removal                  | <p><b>Previously set stains.</b></p> <ul style="list-style-type: none"> <li>Articles that have previously been washed may have stains that have been set. These stains may be difficult to remove and may require hand washing or pre-treating to aid in stain removal.</li> </ul> |
| Musty or mildewy odor in the washer | <p><b>Incorrect or too much detergent has been used.</b></p> <ul style="list-style-type: none"> <li>Use only HE (High-Efficiency) detergent in accordance with the manufacturer's instructions.</li> </ul>   |
|                                     | <p><b>Inside of the drum was not cleaned properly.</b></p> <ul style="list-style-type: none"> <li>Run the <b>Tub Clean</b> cycle regularly.</li> </ul>   |

## Wi-Fi

| Problem  | Possible Cause & Solution   |
|--|---|
| Trouble connecting appliance and smartphone to Wi-Fi network | <p><b>The password for the Wi-Fi network was entered incorrectly.</b></p> <ul style="list-style-type: none"> <li>Delete your home Wi-Fi network and begin the connection process again.</li> </ul>  |
|  | <p><b>Mobile data for your smartphone is turned on.</b></p> <ul style="list-style-type: none"> <li>Turn off the <b>Mobile data</b> on your smartphone before connecting the appliance.</li> </ul>   |
|  | <p><b>The wireless network name (SSID) is set incorrectly.</b></p> <ul style="list-style-type: none"> <li>The wireless network name (SSID) should be a combination of English letters and numbers. (Do not use special characters.)</li> </ul>  |
|  | <p><b>The router frequency is not 2.4 GHz.</b></p> <ul style="list-style-type: none"> <li>Only a 2.4 GHz router frequency is supported. Set the wireless router to 2.4 GHz and connect the appliance to the wireless router. To check the router frequency, check with your Internet service provider or the router manufacturer.</li> </ul>  |
|  | <p><b>The appliance and the router are too far apart.</b></p> <ul style="list-style-type: none"> <li>If the appliance is too far from the router, the signal may be weak and the connection may not be configured correctly. Move the router closer to the appliance or purchase and install a Wi-Fi repeater.</li> </ul>   |
|  | <p><b>LG ThinQ is asking for a password to connect to the product.</b></p> <ul style="list-style-type: none"> <li>If you are asked to provide a password to connect to the <b>product</b> (not to your home network) during the Wi-Fi setup, enter the last 4 characters of the network name, repeated twice, with no spaces. For example, if the network name appears as LG_XXXX_8b92, then you would enter 8b928b92 as your password. The password is case sensitive and the last 4 characters are unique to your appliance.</li> </ul> |



# LIMITED WARRANTY

## USA

### TERMS AND CONDITIONS

**ARBITRATION NOTICE: THIS LIMITED WARRANTY CONTAINS AN ARBITRATION PROVISION THAT REQUIRES YOU AND LG ELECTRONICS (“LG”) TO RESOLVE DISPUTES BY BINDING ARBITRATION INSTEAD OF IN COURT, UNLESS YOU CHOOSE TO OPT OUT. IN ARBITRATION, CLASS ACTIONS AND JURY TRIALS ARE NOT PERMITTED. PLEASE SEE THE SECTION TITLED “PROCEDURE FOR RESOLVING DISPUTES” BELOW.**

Should your LG Washer (“Product”) fail due to a defect in materials or workmanship under normal and proper use, during the warranty period set forth below, LG will, at its option, repair or replace the Product. This limited warranty is valid only to the original retail purchaser of the Product (“You”) and applies only when purchased lawfully and used within the United States including U.S. Territories.

| WARRANTY PERIOD   |  |  |
|---|--|--|
| Washer  | Direct Drive Motor (Stator or Rotor)   | Stainless Steel Drum   |
| Parts (internal/ functional parts only) and Labor: One (1) year from the date of original retail purchase | Parts Only: Ten (10) years from the date of original retail purchase<br>You are responsible for any applicable labor cost. | Parts Only: Lifetime from date of original retail purchase<br>You are responsible for any applicable labor cost. |

- Replacement Products and parts are warranted for the remaining portion of the original warranty period or ninety (90) days, whichever is greater.
- Replacement Products and parts may be new, reconditioned, refurbished, or otherwise factory remanufactured.
- Replaced Product or part(s) will be the property of LG.
- Proof of original retail purchase specifying the Product model and date of purchase is required to obtain warranty service under this limited warranty. In the event of no proof of purchase, warranty start date will be ninety (90) days from the manufacture date.

**EXCEPT TO THE EXTENT PROHIBITED BY APPLICABLE LAW, ANY IMPLIED WARRANTY OF MERCHANTABILITY OR FITNESS FOR A PARTICULAR PURPOSE ON THE PRODUCT IS LIMITED IN DURATION TO THE DURATION OF THE ABOVE LIMITED WARRANTY. UNDER NO CIRCUMSTANCES SHALL LG OR ITS U.S. DISTRIBUTORS/DEALERS BE LIABLE FOR ANY INDIRECT, INCIDENTAL, CONSEQUENTIAL, SPECIAL, OR PUNITIVE DAMAGES, INCLUDING, WITHOUT LIMITATION, LOST GOODWILL, LOST REVENUES OR PROFITS, WORK STOPPAGE, IMPAIRMENT OF OTHER GOODS, COST OF REMOVAL AND REINSTALLATION OF THE PRODUCT, LOSS OF USE, OR ANY OTHER DAMAGES WHETHER BASED IN CONTRACT, TORT, OR OTHERWISE. LG’S TOTAL LIABILITY, IF ANY, SHALL NOT EXCEED THE PURCHASE PRICE PAID BY YOU FOR THE PRODUCT.**

**SOME STATES DO NOT ALLOW THE EXCLUSION OR LIMITATION OF INCIDENTAL OR CONSEQUENTIAL DAMAGES OR LIMITATIONS ON HOW LONG AN IMPLIED WARRANTY LASTS, SO THE ABOVE EXCLUSIONS OR LIMITATIONS MAY NOT APPLY TO YOU. THIS LIMITED WARRANTY GIVES YOU SPECIFIC LEGAL RIGHTS AND YOU MAY ALSO HAVE OTHER RIGHTS THAT VARY FROM STATE TO STATE.**

### THIS LIMITED WARRANTY DOES NOT COVER:

- Service trips to i) deliver, pick up, or install, or; educate how to operate the Product;; ii) correct wiring;; or iii) correct unauthorized repairs or installations of the Product.
- Damage or failure of the Product to perform during power failures and interrupted or inadequate electrical service.

## 42 LIMITED WARRANTY

---

- Damage or failure of the Product caused by leaky or broken water pipes, frozen water pipes, restricted drain lines, inadequate or interrupted water supply, or inadequate supply of air.
- Damage or failure of the Product resulting from operating the Product in a corrosive atmosphere, in an unsuitable environment, or otherwise contrary to the Product owner's manual.
- Damage or failure of the Product caused by accidents, pests and vermin, lightning, wind, fire, floods, pandemics, acts of nature, or any other causes beyond the control of LG.
- Damage or failure of the Product resulting from misuse, abuse, improper installation, repair, or maintenance, or service not approved by LG. Improper repair includes use of parts not authorized or specified by LG. Improper installation or maintenance includes installation or maintenance contrary to the Product's owner's manual.
- Damage or failure of the Product caused by unauthorized modification or alteration, any other property damage or failure resulting from any water leakage where the Product is not properly installed in accordance with the Product's owner's manual.
- Damage or failure of the Product caused by incorrect electrical current, voltage, or plumbing codes.
- Damage or failure of the Product caused by use of parts, accessories, components, consumable cleaning products, any other products, or service that are not authorized by LG.
- Replacement of light bulbs, filters, fuses, or any other consumable parts.
- Damage or failure of the Product caused by transportation, storage, and/or handling, including scratches, dents, chips, and/or other damage to the finish of your Product, unless such damage is reported within one (1) week of delivery.
- Damage or missing items to any display, open box, refurbished, or discounted Product.
- Refurbished Product or any Product sold "As Is", "Where Is", "With all Faults", or similar disclaimer.
- Products with original serial numbers that have been removed, altered, or cannot be readily determined at the discretion of LG.
- Increases in utility costs and additional utility expenses in any way associated with the Product.
- Any noises associated with normal operation.
- Products used for other than normal and proper household use, including, without limitation, commercial or industrial use or, use in offices, and recreational facilities or vehicles, or as otherwise outlined in the Product owner's manual.
- Costs associated with removal and/or reinstallation of your Product.
- The removal and reinstallation of the Product if it is installed in an inaccessible location or is not installed in accordance with the Product owner's manual.

**The cost of repair or replacement under the above excluded circumstances shall be borne by You.**

TO OBTAIN WARRANTY SERVICE AND ADDITIONAL INFORMATION

Call 1-800-243-0000 and select the appropriate option from the menu.

Or visit our website at <http://www.lg.com>

Or by mail: LG Electronics, P.O. Box 240007, Huntsville, AL 35813 ATTN: Customer Service

### PROCEDURE FOR RESOLVING DISPUTES:

ALL DISPUTES BETWEEN YOU AND LG ARISING OUT OF OR RELATING IN ANY WAY TO THIS LIMITED WARRANTY OR THE PRODUCT SHALL BE RESOLVED EXCLUSIVELY THROUGH BINDING ARBITRATION, AND NOT IN A COURT OF GENERAL JURISDICTION. BINDING ARBITRATION MEANS THAT YOU AND LG ARE EACH WAIVING THE RIGHT TO A JURY TRIAL AND TO BRING OR PARTICIPATE IN A CLASS ACTION.

**Definitions.** For the purposes of this section, references to "LG" mean LG Electronics U.S.A., Inc., its parents, subsidiaries and affiliates, and each of their officers, directors, employees, agents, beneficiaries, predecessors in interest, successors, assigns and suppliers; references to "dispute" or "claim" shall include any dispute, claim or controversy of any kind whatsoever (whether based in contract, tort, statute, regulation, ordinance, fraud, misrepresentation or any other legal or equitable theory) arising out of or relating in any way to the sale, condition or performance of the product or this Limited Warranty.

**Notice of Dispute.** In the event you intend to commence an arbitration proceeding, you must first notify LG in writing at least 30 days in advance of initiating the arbitration by sending a letter to LG at LG Electronics, USA, Inc. Attn: Legal Department-Arbitration 111 Sylvan Avenue, Englewood Cliffs, NJ 07632. You and LG agree to engage in good faith discussions in an attempt to amicably resolve your claim. The notice must provide your name, address, and telephone number; identify the product that is the subject of the claim; and describe the nature of the claim and the relief being sought. If you and LG are unable to resolve the dispute within 30 days, either party may proceed to file a claim for arbitration.

**Agreement to Binding Arbitration and Class Action Waiver.** Upon failure to resolve the dispute during the 30 day period after sending written notice to LG, you and LG agree to resolve any claims between us only by binding arbitration on an individual basis, unless you opt out as provided below. Any dispute between you and LG shall not be combined or consolidated with a dispute involving any other person's or entity's product or claim. More specifically, without limitation of the foregoing, any dispute between you and LG shall not under any circumstances proceed as part of a class or representative action. Instead of arbitration, either party may bring an individual action in small claims court, but that small claims court action may not be brought on a class or representative basis.

**Arbitration Rules and Procedures.** To begin arbitration of a claim, either you or LG must make a written demand for arbitration. The arbitration will be administered by the American Arbitration Association ("AAA") and will be conducted before a single arbitrator under the AAA's Consumer Arbitration Rules that are in effect at the time the arbitration is initiated (referred to as the "AAA Rules") and under the procedures set forth in this section. The AAA Rules are available online at [www.adr.org/consumer](http://www.adr.org/consumer). Send a copy of your written demand for arbitration, as well as a copy of this provision, to the AAA in the manner described in the AAA Rules. You must also send a copy of your written demand to LG at LG Electronics, USA, Inc. Attn: Legal Department-Arbitration 111 Sylvan Avenue, Englewood Cliffs, NJ 07632. If there is a conflict between the AAA Rules and the rules set forth in this section, the rules set forth in this section will govern. This arbitration provision is governed by the Federal Arbitration Act. Judgment may be entered on the arbitrator's award in any court of competent jurisdiction. All issues are for the arbitrator to decide, except that issues relating to the scope and enforceability of the arbitration provision and to the arbitrability of the dispute are for the court to decide. The arbitrator is bound by the terms of this provision.

**Governing Law.** The law of the state of your residence shall govern this Limited Warranty and any disputes between us except to the extent that such law is preempted by or inconsistent with applicable federal law.

**Fees/Costs.** You do not need to pay any fee to begin an arbitration. Upon receipt of your written demand for arbitration, LG will promptly pay all arbitration filing fees to the AAA unless you seek more than \$25,000 in damages, in which case the payment of these fees will be governed by the AAA Rules. Except as otherwise provided for herein, LG will pay all AAA filing, administration and arbitrator fees for any arbitration initiated in accordance with the AAA Rules and this arbitration provision. If you prevail in the arbitration, LG will pay your attorneys' fees and expenses as long as they are reasonable, by considering factors including, but not limited to, the purchase amount and claim amount. Notwithstanding the foregoing, if applicable law allows for an award of reasonable attorneys' fees and expenses, an arbitrator can award them to the same extent that a court would. If the arbitrator finds either the substance of your claim or the relief sought in the demand is frivolous or brought for an improper purpose (as measured by the standards set forth in Federal Rule of Civil Procedure 11(b)), then the payment of all arbitration fees will be governed by the AAA Rules. In such a situation, you agree to reimburse LG for all monies previously disbursed by it that are otherwise your obligation to pay under the AAA Rules. Except as otherwise provided for, LG waives any rights it may have to seek attorneys' fees and expenses from you if LG prevails in the arbitration.

**Hearings and Location.** If your claim is for \$25,000 or less, you may choose to have the arbitration conducted solely on the basis of (1) documents submitted to the arbitrator, (2) through a telephonic hearing, or (3) by an in-person hearing as established by the AAA Rules. If your claim exceeds \$25,000, the right to a hearing will be determined by the AAA Rules. Any in-person arbitration hearings will be held at a location within the federal judicial district in which you reside unless we both agree to another location or we agree to a telephonic arbitration.

**Opt Out.** You may opt out of this dispute resolution procedure. If you opt out, neither you nor LG can require the other to participate in an arbitration proceeding. To opt out, you must send notice to LG no later than 30 calendar days from the date of the first consumer purchaser's purchase of the product by either: (i) sending an e-mail to [optout@lge.com](mailto:optout@lge.com), with the subject line: "Arbitration Opt Out" or (ii) calling 1-

#### 44 LIMITED WARRANTY

---

800-980-2973. You must include in the opt out e-mail or provide by telephone: (a) your name and address; (b) the date on which the product was purchased; (c) the product model name or model number; and (d) the serial number (the serial number can be found (i) on the product; or (ii) online by accessing <https://www.lg.com/us/support/repair-service/schedule-repair-continued> and clicking on "Find My Model & Serial Number").

You may only opt out of the dispute resolution procedure in the manner described above (that is, by e-mail or telephone); no other form of notice will be effective to opt out of this dispute resolution procedure. Opting out of this dispute resolution procedure will not affect the coverage of the Limited Warranty in any way, and you will continue to enjoy the full benefits of the Limited Warranty. If you keep this product and do not opt out, then you accept all terms and conditions of the arbitration provision described above.

# CANADA

## TERMS AND CONDITIONS

**ARBITRATION NOTICE: THIS LIMITED WARRANTY CONTAINS AN ARBITRATION PROVISION THAT REQUIRES YOU AND LG TO RESOLVE DISPUTES BY BINDING ARBITRATION INSTEAD OF IN COURT, UNLESS THE LAWS OF YOUR PROVINCE OR TERRITORY DO NOT PERMIT THAT, OR, IN OTHER JURISDICTIONS, IF YOU CHOOSE TO OPT OUT. IN ARBITRATION, CLASS ACTIONS AND JURY TRIALS ARE NOT PERMITTED. PLEASE SEE THE SECTION TITLED "PROCEDURE FOR RESOLVING DISPUTES" BELOW.**

Should your LG Washer ("Product") fail due to a defect in materials or workmanship under normal and proper use, during the warranty period set forth below, LG Electronics Canada, Inc. ("LGECI") will, at its option, repair or replace the Product upon receipt of proof of the original retail purchase. This limited warranty is valid only to the original retail purchaser of the Product and applies only to a Product distributed, purchased and used within Canada, as determined at the sole discretion of LGECI.

| <b>WARRANTY PERIOD (Note: If the original date of purchase cannot be verified, the warranty will begin sixty (60) days from the date of manufacture)</b> |   |  |
|--|---|--|
| <b>Washer</b>  | <b>Stainless Steel Drum</b>                               | <b>Direct Drive Motor (Motor or Rotor)</b>               |
| One (1) year from the date of original retail purchase   | Three (3) years from the date of original retail purchase | Ten (10) years from the date of original retail purchase |
| Parts and Labor (internal/functional parts only)   | Parts only (Consumer will be charged for labor)           | Part only (Consumer will be charged for labor)           |

- Replacement products and parts are warranted for the remaining portion of the original warranty period or ninety (90) days, whichever is greater.
- Replacement products and parts may be new, reconditioned, refurbished, or otherwise factory remanufactured, all at the sole discretion of LGECI.
- Proof of original retail purchase specifying the Product model and date of purchase is required to obtain warranty service under this Limited Warranty.

**LGECI'S SOLE LIABILITY IS LIMITED TO THE LIMITED WARRANTY SET OUT ABOVE. EXCEPT AS EXPRESSLY PROVIDED ABOVE, LGECI MAKES NO, AND HEREBY DISCLAIMS, ALL OTHER WARRANTIES AND CONDITIONS RESPECTING THE PRODUCT, WHETHER EXPRESS OR IMPLIED, INCLUDING BUT NOT LIMITED TO, ANY IMPLIED WARRANTY OR CONDITION OF MERCHANTABILITY OR FITNESS FOR A PARTICULAR PURPOSE, AND NO REPRESENTATIONS SHALL BE BINDING ON LGECI. LGECI DOES NOT AUTHORIZE ANY PERSON TO CREATE OR ASSUME FOR IT ANY OTHER WARRANTY OBLIGATION OR LIABILITY IN CONNECTION WITH THE PRODUCT. TO THE EXTENT THAT ANY WARRANTY OR CONDITION IS IMPLIED BY LAW, IT IS LIMITED TO THE WARRANTY PERIOD SET OUT ABOVE. UNDER NO CIRCUMSTANCES SHALL LGECI, THE MANUFACTURER OR DISTRIBUTOR OF THE PRODUCT, BE LIABLE FOR ANY INCIDENTAL, CONSEQUENTIAL, SPECIAL, DIRECT, INDIRECT, PUNITIVE OR EXEMPLARY DAMAGES, INCLUDING, WITHOUT LIMITATION, LOSS OF GOODWILL, LOST PROFITS, LOSS OF ANTICIPATED PROFITS, LOST REVENUE, LOSS OF USE, OR ANY OTHER DAMAGE, WHETHER ARISING DIRECTLY OR INDIRECTLY FROM ANY CONTRACTUAL BREACH, FUNDAMENTAL BREACH, TORT OR OTHERWISE, OR FROM ANY ACTS OR OMISSIONS. LGECI'S TOTAL LIABILITY, IF ANY, SHALL NOT EXCEED THE PURCHASE PRICE PAID BY YOU FOR THE PRODUCT.**

This Limited Warranty gives you specific legal rights. You may also have other rights that vary from province to province depending on applicable provincial laws. Any term of this Limited Warranty that negates or varies any implied condition or warranty under provincial law is severable where it conflicts with such provincial law without affecting the remainder of this warranty's terms.

### **THIS LIMITED WARRANTY DOES NOT COVER:**

- Service trips to i) deliver, pick up, or install or; educate on how to operate the Product; ii) correct wiring or plumbing; or iii) correct unauthorized repairs or installations of the Product;

- Damage or failure of the Product to perform during power failures and interrupted or inadequate electrical service;
- Damage or failure caused by leaky or broken water pipes, frozen water pipes, restricted drain lines, inadequate or interrupted water supply or inadequate supply of air;
- Damage or failure resulting from operating the Product in a corrosive atmosphere or contrary to the instructions outlined in the Product's owner's manual;
- Damage or failure to the Product caused by accidents, pests and vermin, lightning, wind, fire, floods, acts of God, or any other causes beyond the control of LGECI or the manufacturer;
- Damage or failure resulting from misuse, abuse, improper installation, repair, or maintenance of the Product. Improper repair includes use of parts not authorized or specified by LGECI. Improper installation or maintenance includes installation or maintenance contrary to the Product's owner's manual;
- Damage or failure caused by unauthorized modification or alteration of the Product, or if used for other than the intended household purpose/use of the Product, or damage or failure resulting from any water leakage due to improper installation of the Product;
- Damage or failure caused by incorrect electrical current, voltage or plumbing codes;
- Damage or failure caused by use that is other than normal household use, including, without limitation, commercial or industrial use, including use in commercial offices or recreational facilities, or as otherwise outlined in the Product's owner's manual;
- Damage or failure caused by the use of any accessories, components or cleaning products, including, without limitation, that are not approved/authorized by LGECI;
- Damage or failure caused by transportation and handling, including scratches, dents, chips and/or other damage to the finish of the Product, unless such damage results from defects in materials or workmanship and is reported to LGECI within one (1) week of delivery of the Products;
- Damage or missing items to any display, open box, refurbished or discounted Product;
- Refurbished Product or any Product sold "As Is", "Where Is", "With all Faults", or any similar disclaimer;
- Products with original serial numbers that have been removed, altered or cannot be readily determined at the discretion of LGECI;
- Increases in utility costs and additional utility expenses in any way associated with the Product;
- Replacement of light bulbs, filters, fuses or any other consumable parts;
- Costs associated with removal and/or reinstallation of the Product for repairs;
- Noises associated with normal operation and failure to follow instructions found in the use and care and installation guides or operating the unit in an unsuitable environment will not be covered under this warranty.
- Coverage for "in Home" repairs, for products in-warranty, will be provided if the Product is within a 150 km radius from the nearest authorized service center (ASC), as determined by LG Canada. If your Product is located outside a 150 km radius from a ASC, as determined by LG Canada, it will be your responsibility to bring the Product, at your sole expense, to the ASC for in-warranty repair.

**All costs and expenses associated with the above excluded circumstances, listed under the heading, This Limited Warranty Does Not Cover, shall be borne by the consumer.**

TO OBTAIN WARRANTY SERVICE AND ADDITIONAL INFORMATION, PLEASE CALL OR VISIT OUR WEBSITE:

Call 1-888-542-2623 and select the appropriate option from the menu, or visit our website at <http://www.lg.com>

### PROCEDURE FOR RESOLVING DISPUTES:

EXCEPT WHERE PROHIBITED AT LAW, ALL DISPUTES BETWEEN YOU AND LG ARISING OUT OF OR RELATING IN ANY WAY TO THIS LIMITED WARRANTY OR THE PRODUCT SHALL BE RESOLVED EXCLUSIVELY THROUGH BINDING ARBITRATION, AND NOT IN A COURT OF GENERAL JURISDICTION. EXCEPT WHERE PROHIBITED AT LAW, YOU AND LG BOTH IRREVOCABLY AGREE TO WAIVE THE RIGHT TO A JURY TRIAL AND TO BRING OR PARTICIPATE IN A CLASS ACTION.

**Definitions.** For the purposes of this section, references to “LG” mean LG Electronics Canada, Inc., its parents, subsidiaries and affiliates, and each of their officers, directors, employees, agents, beneficiaries, predecessors in interest, successors, assigns and suppliers; references to “dispute” or “claim” shall include any dispute, claim or controversy of any kind whatsoever (whether based in contract, tort, statute, regulation, ordinance, fraud, misrepresentation or any other legal or equitable theory) arising out of or relating in any way to the sale, condition or performance of the product or this Limited Warranty.

**Notice of Dispute.** In the event you intend to commence an arbitration proceeding, you must first notify LG in writing at least 30 days in advance of initiating the arbitration by sending a letter to LGECI Legal Team at 20 Norelco Drive, North York, Ontario, Canada M9L 2X6 (the “Notice of Dispute”). You and LG agree to engage in good faith discussions in an attempt to amicably resolve your claim. The notice must provide your name, address, and telephone number; identify the product that is the subject of the claim; and describe the nature of the claim and the relief being sought. If you and LG are unable to resolve the dispute within 30 days of LG’s receipt of the Notice of Dispute, the dispute shall be resolved by binding arbitration in accordance with the procedure set out herein. You and LG both agree that, during the arbitration proceeding, the terms (including any amount) of any settlement offer made by either you or LG will not be disclosed to the arbitrator until the arbitrator determines the dispute.

**Agreement to Binding Arbitration and Class Action Waiver.** Upon failure to resolve the dispute during the 30 day period after LG’s receipt of the Notice of Dispute, you and LG agree to resolve any claims between you and LG only by binding arbitration on an individual basis, unless you opt out as provided below, or you reside in a jurisdiction that prevents full application of this clause in the circumstances of the claims at issue (in which case if you are a consumer, this clause will only apply if you expressly agree to the arbitration). To the extent permitted by applicable law, any dispute between you and LG shall not be combined or consolidated with a dispute involving any other person’s or entity’s product or claim. More specifically, without limitation of the foregoing, except to the extent such a prohibition is not permitted at law, any dispute between you and LG shall not under any circumstances proceed as part of a class or representative action. Instead of arbitration, either party may bring an individual action in small claims court, but that small claims court action may not be brought on a class or representative basis except to the extent this prohibition is not permitted at law in your province or territory of jurisdiction as it relates to the claims at issue between you and LG.

**Arbitration Rules and Procedures.** To begin arbitration of a claim, either you or LG must make a written demand for arbitration. The arbitration will be private and confidential, and conducted on a simplified and expedited basis before a single arbitrator chosen by the parties under the provincial or territorial commercial arbitration law and rules of the province or territory of your residence. You must also send a copy of your written demand to LG at LG Electronics, Canada, Inc., Attn: Legal Department- Arbitration, 20 Norelco Drive, North York, Ontario M9L 2X6. This arbitration provision is governed by your applicable provincial or territorial commercial arbitration legislation. Judgment may be entered on the arbitrator’s award in any court of competent jurisdiction. All issues are for the arbitrator to decide, except that, issues relating to the scope and enforceability of the arbitration provision and to the arbitrability of the dispute are for the court to decide. The arbitrator is bound by the terms of this provision.

**Governing Law.** The law of the province or territory of your purchase shall govern this Limited Warranty and any disputes between you and LG except to the extent that such law is preempted by or inconsistent with applicable federal or provincial/territorial law. Should arbitration not be permitted for any claim, action, dispute or controversy between you and LG, you and LG attorn to the exclusive jurisdiction of the courts of the province or territory of your purchase for the resolution of the claim, action, dispute or controversy between you and LG.

**Fees/Costs.** You do not need to pay any fee to begin an arbitration. Upon receipt of your written demand for arbitration, LG will promptly pay all arbitration filing fees unless you seek more than \$25,000 in damages, in which case the payment of these fees will be governed by the applicable arbitration rules. Except as otherwise provided for herein, LG will pay all filing, administration and arbitrator fees for any arbitration initiated in accordance with the applicable arbitration rules and this arbitration provision. If you prevail in the arbitration, LG will pay your attorneys’ fees and expenses as long as they are reasonable, by considering factors including, but not limited to, the purchase amount and claim amount. Notwithstanding the foregoing, if applicable law allows for an award of reasonable attorneys’ fees and expenses, an arbitrator can award them to the same extent that a court would. If the arbitrator finds either the substance of your claim or the relief sought in the demand is frivolous or brought for an improper purpose (as measured by the applicable laws), then the payment of all arbitration fees will be governed by the applicable arbitration rules. In such a situation, you agree to reimburse LG for all monies previously disbursed by it that are otherwise your obligation to pay under the applicable arbitration rules. Except as

otherwise provided for, LG waives any rights it may have to seek attorneys' fees and expenses from you if LG prevails in the arbitration.

**Hearings and Location.** If your claim is for \$25,000 or less, you may choose to have the arbitration conducted solely (1) on the basis of documents submitted to the arbitrator, (2) through a telephonic hearing, or (3) by an in-person hearing as established by the applicable arbitration rules. If your claim exceeds \$25,000, the right to a hearing will be determined by the applicable arbitration rules. Any in-person arbitration hearings will be held at the nearest, most mutually-convenient arbitration location available within the province or territory in which you reside unless you and LG both agree to another location or agree to a telephonic arbitration.

**Severability and Waiver.** If any portion of this Limited Warranty (including these arbitration procedures) is unenforceable, the remaining provisions will continue in full force and effect to the maximum extent permitted by applicable law. Should LG fail to enforce strict performance of any provision of this Limited Warranty (including these arbitration procedures), it does not mean that LG intends to waive or has waived any provision or part of this Limited Warranty.

**Opt Out.** You may opt out of this dispute resolution procedure. If you opt out, neither you nor LG can require the other to participate in an arbitration proceeding. To opt out, you must send notice to LG no later than 30 calendar days from the date of the first consumer purchaser's purchase of the product by either (i) sending an e-mail to [optout@lge.com](mailto:optout@lge.com), with the subject line: "Arbitration Opt Out;" or (ii) calling 1-800-980-2973. You must include in the opt out e-mail or provide by telephone: (a) your name and address; (b) the date on which the product was purchased; (c) the product model name or model number; and (d) the serial number (the serial number can be found (i) on the product; or (ii) online by accessing [https://www.lg.com/ca\\_en/support/repair-service/schedule-repair](https://www.lg.com/ca_en/support/repair-service/schedule-repair) and clicking on "Find My Model & Serial Number").

In the event that you "Opt Out", the law of the province or territory of your residence shall govern this Limited Warranty and any disputes between you and LG except to the extent that such law is preempted by or inconsistent with applicable federal or provincial/territorial law. Should arbitration not be permitted for any claim, action, dispute or controversy between you and LG, you and LG agree to attorn to the exclusive jurisdiction of the courts of the province or territory of your residence for the resolution of the claim, action, dispute or controversy between you and LG.

You may only opt out of the dispute resolution procedure in the manner described above (that is, by e-mail or telephone); no other form of notice will be effective to opt out of this dispute resolution procedure. Opting out of this dispute resolution procedure will not affect the coverage of the Limited Warranty in any way, and you will continue to enjoy the full benefits of the Limited Warranty. If you keep this product and do not opt out, then you accept all terms and conditions of the arbitration provision described above.

**Conflict of Terms.** In the event of a conflict or inconsistency between the terms of this Limited Warranty and the End User License Agreement ("EULA") in regards to dispute resolution, the terms of this Limited Warranty shall control and govern the rights and obligations of the parties and shall take precedence over the EULA.











**LG**

Life's Good

LG Customer Information Center

For inquiries or comments,  
visit **www.lg.com** or call:

**1-800-243-0000** U.S.A.

**1-888-542-2623** CANADA

Register your product Online!

**www.lg.com**