

MICROWAVE OVEN

RVM320



Features and Functions

- Instant sensor settings for cooking, reheating foods, and popping popcorn
- Fast action keys save time and make microwaving easy
- Defrost programs quickly defrost meat and poultry by weight
- Add-A-Minute adds one minute of extra cooking time with the touch of a button
- Keep Warm Plus feature allows food to be kept warm for up to 30 minutes
- Child lock safety feature locks the control panel to prevent unwanted operation

Spacious Oven Cavity

- 2.0 cubic ft. oven capacity
- 17 3/8" wide
- 10 1/2" high
- 18 5/8" deep
- 16" diameter turntable
- Interior light

Installation Options

- Place on countertop or install as a built-in using an optional trim kit
- Built-in trim kit designed to match corresponding ovens and warming drawers
- 30" width (RVMTK330)

Finish

- Available in Stainless Steel (SS)



Warranty Highlights

- One-year full – complete product
- Ninety-day full – cosmetic parts such as glass, painted items, and decorative items
- Five-year limited – magnetron tube



30" Wide Conventional Microwave Oven

MICROWAVE OVEN
RVM320



DESCRIPTION	MICROWAVE OVEN	30" WIDE BUILT-IN TRIM KIT
	RVM320	RVMTK330
Overall Width	24" (60.9 cm)	29 1/2" (74.9 cm)
Overall Height	13 3/8" (33.9 cm)	18 1/4" (46.3 cm)
Overall Depth	19 1/4" (48.9 cm)	–
Cutout Width	–	27 3/4" (70.5 cm) minimum
		28" (71.1 cm) maximum
Cutout Height	–	16 9/16" (42.1 cm) minimum
		16 13/16" (42.7 cm) maximum
Cutout Depth	–	20" (50.8 cm) minimum
Electrical Requirements	120VAC/60Hz	–
Maximum Amp Usage	1.5 kW, 13.0 amps	–
Oven Interior Dimensions	Width – 17 3/8" (44.1 cm) Height – 10 1/2" (26.6 cm) Depth – 18 5/8" (47.3 cm) Overall Size – 2.0 cu. ft.	–
Approximate Shipping Weight	46 lb. (20.9 kg)	15 lb. (6.9 kg)

Please do not prepare installation from brochure data only. See installation instructions for important clearance/installation information.

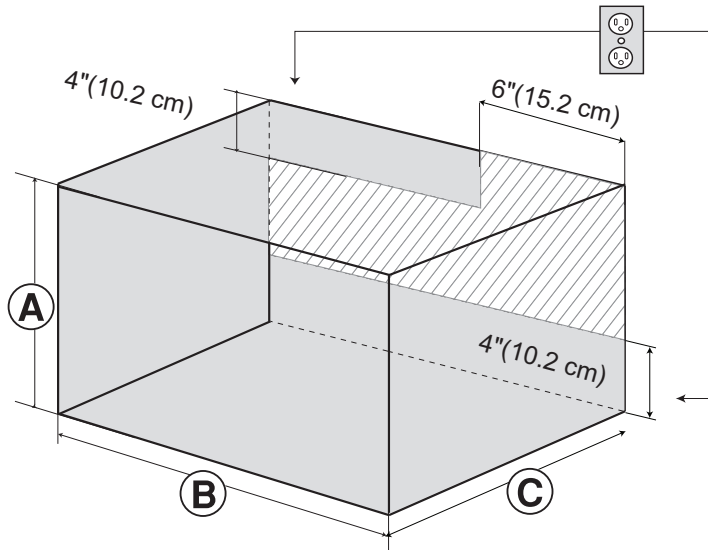

CUTOUT DIMENSIONS	
A	16 9/16" (42.1 cm) minimum Standard – 16 13/16" (42.7 cm) maximum
B	27 3/4" (70.5 cm) minimum Standard – 28" (71.1 cm) maximum
C	20" (50.8 cm) minimum



VIKING RANGE, LLC 111 FRONT STREET GREENWOOD, MISSISSIPPI 38930 USA

For detailed product information, model numbers, or to request a quote call 1-888-845-4641 or visit vikingrange.com
© 2013 Viking Range, LLC | Specifications subject to change without notice.