



New
Classic®
FURNITURE

ASSEMBLY INSTRUCTIONS



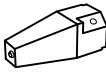

B1655-040 OBSIDIAN NIGHTSTAND

Thank you for purchasing this quality product. Be sure to check all packing materials carefully for small parts, which may have come loose inside the carton during shipment. Identify and count all items and compare with the parts list and/or hardware list shown.

PARTS LIST

NO	COMPONENT	DRAWING	QTY
A	Nightstand		1 pc
B	Bun Foot		4 pcs

HARDWARE LIST

NO	COMPONENT	DRAWING	QTY
1	JCBC M6 x 2" Blk		4 pcs
2	Spring Washer 1/4" Blk		4 pcs
3	Flat Washer 1/4"IDx6/8"OD Blk		4 pcs
4	Allen Key M4 x 2 9/16" Blk		1 pc

STEP 1 : Pull the drawer and take out the Bunfoot carton (B). Attach the Bunfoot (B) at the bottom Night Stand (A) used JCBC (1) with Spring Washer (2) Flat Washer (3) and tighten with Allen Key (4).

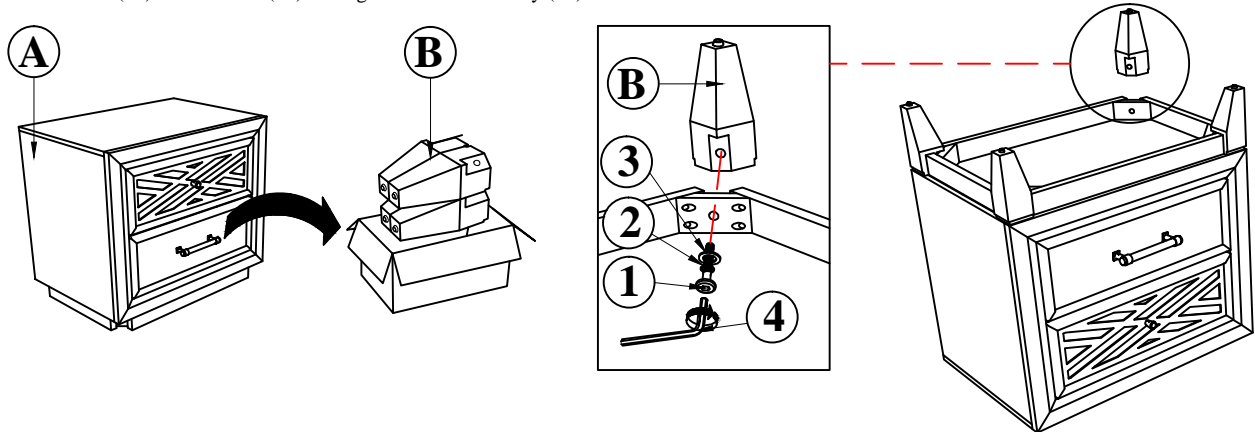

STEP 2 : COMPLETE

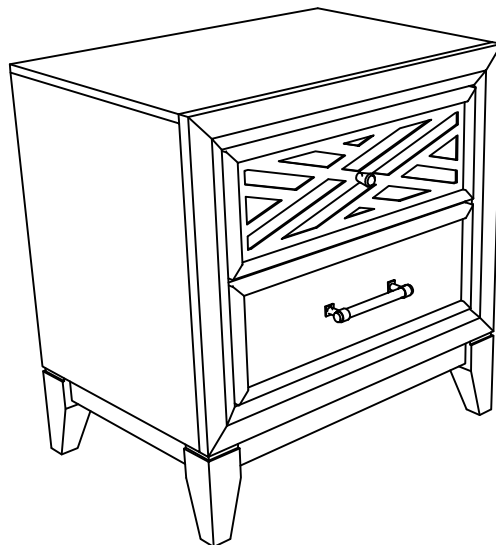

COMPLETED ASSEMBLY

NOTE : MUST TIGHTEN SCREWS PERIODCALLY WITH USE SCREW WILL BECOME LOOSE CHECK TIGHTNESS OF ALL SCREW EVERY 6-8 WEEKS.