

SAMSUNG

Product Guide

Bespoke 30" Double Wall Oven with AI Pro Cooking™ Camera

NV51**700D

Available in:

Bespoke White Glass

Bespoke Stainless Steel

Bespoke Matte Black Steel



Table of Contents

NV51**700D - Bespoke 30" Double Wall Oven with AI Pro Cooking™ Camera

Product Overview

Product Overview	4
Carousel Image Order	5

Product Messaging

Features and Benefits	7
Product Videos	12
Primary Lifestyle Images	13
Additional Lifestyle Image	14
Fact Tag Guidance	15

Product Specs

Spec Sheet	17
Install Manuals and Warranty Information	18

Feature Icons

20

Product Overview

NV51700D – Bespoke 30" Double Wall Oven
with AI Pro Cooking™ Camera**

Product Overview

Product Title Bespoke 30" Double Wall Oven with AI Pro Cooking™ Camera

Product Description (Paragraph)

The Samsung Bespoke 30" Double Wall Oven with AI Pro Cooking™ Camera features stunning glass and steel finishes that complement other Bespoke appliances in your kitchen. Rich with features like an AI Pro Cooking™ Camera, Air Sous Vide, Steam Cook Plus and Air Fry, you'll enjoy cooking just like a professional in your own kitchen. Bespoke is Samsung's premium line of home appliances, leading the way in design, technology, and connectivity. Create a kitchen that expresses your personal style.

Short Product Description (bullets)

- The Samsung Bespoke 30" Double Wall Oven with AI Pro Cooking™ Camera features stunning glass and steel finishes that complement other Bespoke appliances in your kitchen.
- The AI Pro Cooking™ Camera live streams video to your smartphone so you can easily check on meals as they cook.*
- Air Sous Vide preserves your food's natural flavor & avoids overcooking. Precise, controlled heat and airflow within the oven gives you sous vide results without the water bath.**
- Steam Cook Plus helps you create healthier dishes by fully cooking with only steam, which retains its nutrients.***
- Bespoke is Samsung's premium line of home appliances, leading the way in design, technology, and connectivity. Create a kitchen that expresses your personal style.

*Available on Android and iOS devices. A Wi-Fi connection and a Samsung account are required. Camera is located at the top of the oven; view of lower racks may be obstructed. A single ingredient dish should be placed in the center of the oven, unobstructed. Keep camera lens clean. Recognition accuracy depends on usage conditions; for more detailed information, please refer to the user guide.

**Requires a sous vide cooking bag, which is not included with the oven.

***Requires Samsung's Steam Cook Tray, sold separately. Only available on Samsung 7000 series models.

Easy Ads Links

White Glass: <https://dam.gettyimages.com/p/z0c3461/digital-appliances?o=AND&q=NV51CB700D12>

Stainless Steel: <https://dam.gettyimages.com/p/z0c3461/digital-appliances?o=AND&q=NV51CG700DSR>

Matte Black Steel: <https://dam.gettyimages.com/p/z0c3461/digital-appliances?o=AND&q=NV51CG700DMT>

Available Colors



**Bespoke
White Glass**
NV51CB700D12

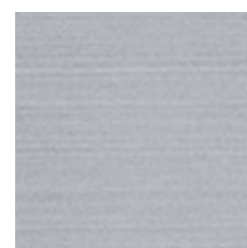

**Bespoke
Stainless Steel**
NV51CG700DSR



**Bespoke
Black Matte Steel**
NV51CG700DMT

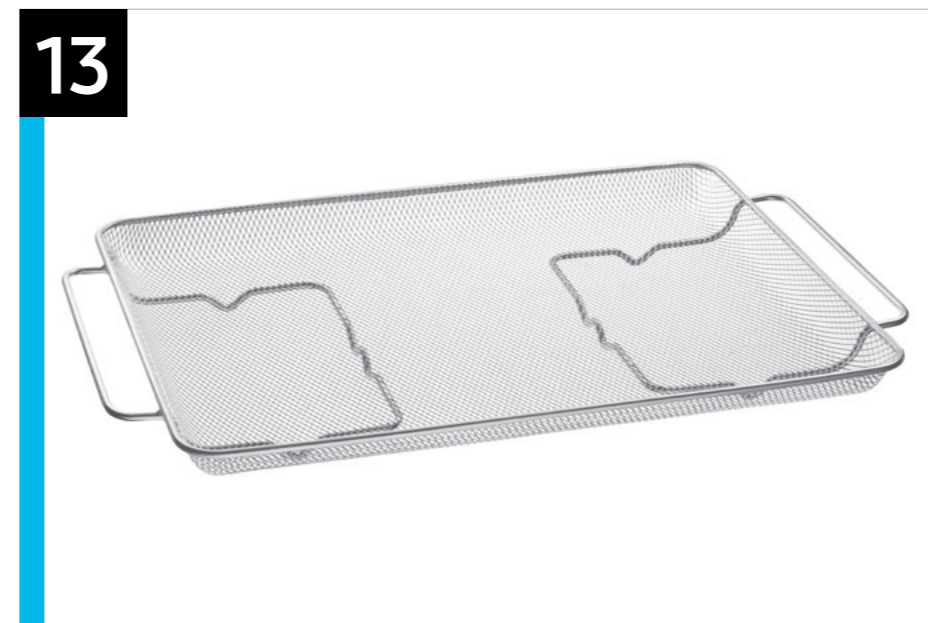
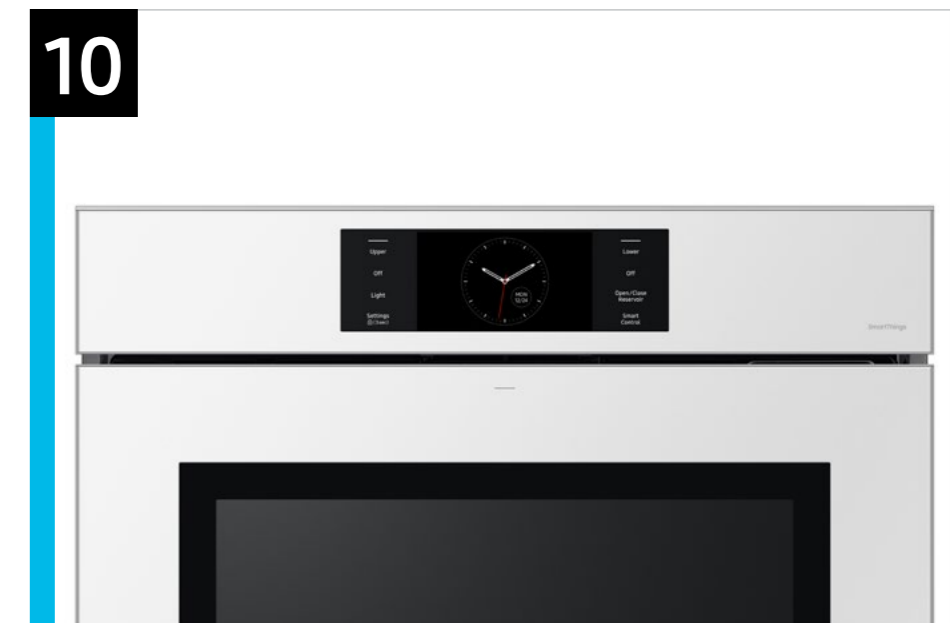

Carousel Image Order



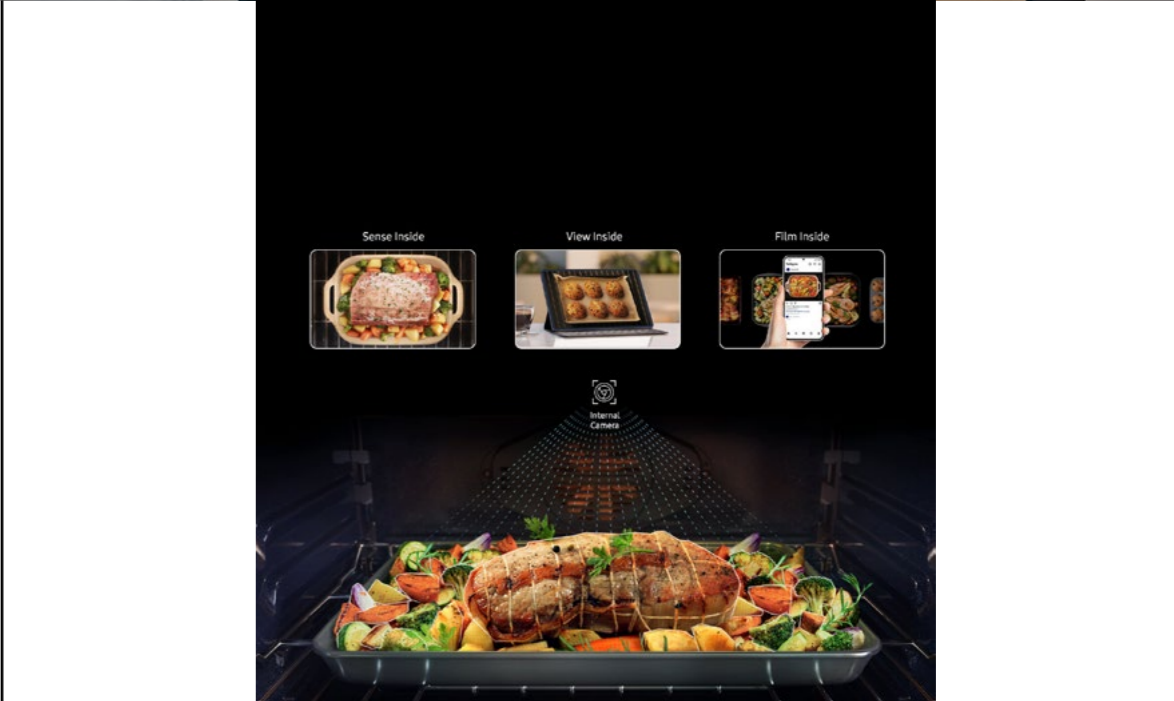

Product Messaging

NV51700D – Bespoke 30" Double Wall Oven
with AI Pro Cooking™ Camera**



Features and Benefits – NV51**700D

Overall Product Headline	Feature Name	Long Body Copy	Short Body Copy	Associated Image
<p>NA</p>	<p>Bespoke Design</p>	<p>Bespoke is Samsung’s premium line of home appliances that leads the way in design, technology, and connectivity. Create a kitchen that expresses your personal style.</p>	<p>Create a kitchen that expresses your personal style.</p>	
<p>Convenient and fun cooking</p>	<p>AI Pro Cooking™ Camera</p>	<p>The AI Pro Cooking™ Camera live streams video to your smartphone so you can easily check on meals as they cook.* Just for fun, you can make and share time-lapse videos to your social media during cooking. The camera can recognize**popular ingredients and suggest optimal cooking modes and settings for many recipes.</p> <p><small>*Available on Android and iOS devices. A Wi-Fi connection and a Samsung account are required. **Camera is located at the top of the oven; view of lower racks may be obstructed. A single ingredient dish should be placed in the center of the oven, unobstructed. Keep camera lens clean. Recognition accuracy depends on usage conditions; for more detailed information, please refer to the user guide.</small></p>	<p>The AI Pro Cooking™ Camera lets you check on meals by streaming video to your smartphone.* Share what’s cooking on your social media platforms with family and friends.</p> <p><small>*Available on Android and iOS devices. A Wi-Fi connection and a Samsung account are required.</small></p>	
<p>One oven or two? You choose.</p>	<p>Flex Duo™ Dual Oven</p>	<p>The Flex Duo™ removable divider and dual temperature controls let you convert one oven into two so you can cook multiple meals at one time at entirely different temperatures or settings.</p>	<p>Save time and convert one oven into two with the Flex Duo™ dual oven. Cook multiple meals at one time at entirely different temperatures or settings.</p>	 <p>Asset available as a .GIF</p>

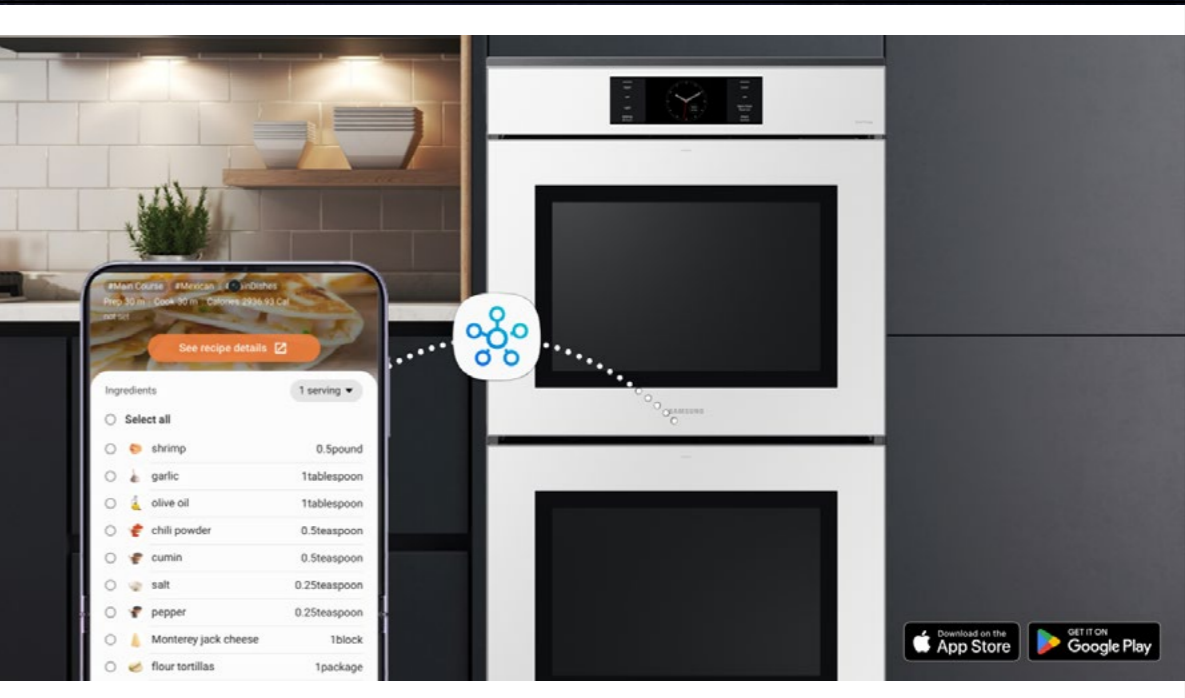

Features and Benefits – NV51**700D (Continued)

Overall Product Headline	Feature Name	Long Body Copy	Short Body Copy	Associated Image
<p>Push to open handle-free door</p>	<p>Handle-Free door design</p>	<p>The oven door easily opens with a simple push.</p>	<p>The oven door easily opens with a simple push.</p>	 <p>Asset available as a .GIF</p>
<p>Say goodbye to dry</p>	<p>Air Sous Vide</p>	<p>Preserve your food’s natural flavor & avoid overcooking. Precise, controlled heat and airflow within the oven gives you sous vide results without the water bath.* Perfect for fish, poultry, and vegetables.</p> <p>* Requires a sous vide cooking bag, which is not included with the oven.</p>	<p>Preserve your food’s natural flavor & avoid overcooking using air sous vide.*</p> <p>* Requires a sous vide cooking bag, which is not included with the oven.</p>	
<p>Preheat and plan meals on the go</p>	<p>SmartThings App</p>	<p>The SmartThings App lets you search recipes, plan meals, and pre-heat your oven from your smartphone.*</p> <p>*Available on Android and iOS devices. A Wi-Fi connection and a Samsung account are required.</p>	<p>The SmartThings App lets you search recipes, plan meals, and pre-heat your oven from your smartphone.*</p> <p>*Available on Android and iOS devices. A Wi-Fi connection and a Samsung account are required.</p>	

Features and Benefits – NV51**700D (Continued)

Overall Product Headline	Feature Name	Long Body Copy	Short Body Copy	Associated Image
<p>Monitor and control energy usage</p>	<p>SmartThings Energy®</p>	<p>SmartThings Energy® lets you monitor and manage your wall oven's power usage. Get energy saving tips and alerts to help lower your electric bill.*</p> <p><small>*Available on Android and iOS devices. A Wi-Fi connection and a Samsung account are required.</small></p>	<p>SmartThings Energy® lets you monitor and manage your wall oven's power usage.</p> <p><small>*Available on Android and iOS devices. A Wi-Fi connection and a Samsung account are required.</small></p>	
<p>Moist and flavorful foods</p>	<p>Steam Cook</p>	<p>An easy-fill water tray lets you bake, broil, and roast with added steam, resulting in foods that are moist and flavorful.</p>	<p>Bake, broil, and roast with added steam, resulting in foods that are moist and flavorful.</p>	
<p>Healthier cooking with steam</p>	<p>Steam Cook Plus</p>	<p>Create healthier dishes using Samsung's Steam Cook Tray.* Foods can be fully cooked with only steam, which retains its nutrients.</p> <p><small>*Requires Samsung's Steam Cook Tray, sold separately. Only available on Samsung 7000 series models.</small></p>	<p>Create healthier dishes. Foods can be fully cooked* with only steam, which retains its nutrients.</p> <p><small>*Requires Samsung's Steam Cook Tray, sold separately. Only available on Samsung 7000 series models.</small></p>	

Features and Benefits – NV51**700D (Continued)

Overall Product Headline	Feature Name	Long Body Copy	Short Body Copy	Associated Image
<p>Cooking with a crunch, now healthier*</p> <p><small>*As compared to deep frying.</small></p>	<p>No-preheat Air Fry</p>	<p>Enjoy healthier* fried foods fast without storing another small appliance in your kitchen, by using Air Fry mode, built right into your oven. Air Fry tray included.</p> <p><small>*As compared to deep frying.</small></p>	<p>Enjoy healthier* fried foods fast by using Air Fry, built right into your oven. Air Fry tray included.</p> <p><small>*As compared to deep frying.</small></p>	
<p>Nutritious and delicious vegetables</p>	<p>Convection Vegetable</p>	<p>Quickly cook crispy vegetables, no preheating needed.</p>	<p>Quickly cook crispy vegetables.</p>	
<p>Easy to monitor and control</p>	<p>7" LCD screen</p>	<p>Make cooking easy with a control panel that has a large 7" LCD display. It's easy to read with large text and icons so you can easily adjust settings and monitor your cooking progress, even from a distance.</p>	<p>The large 7" LCD display is easy to read, so you can adjust settings and monitor your cooking progress, even from a distance.</p>	

Features and Benefits – NV51**700d (Continued)

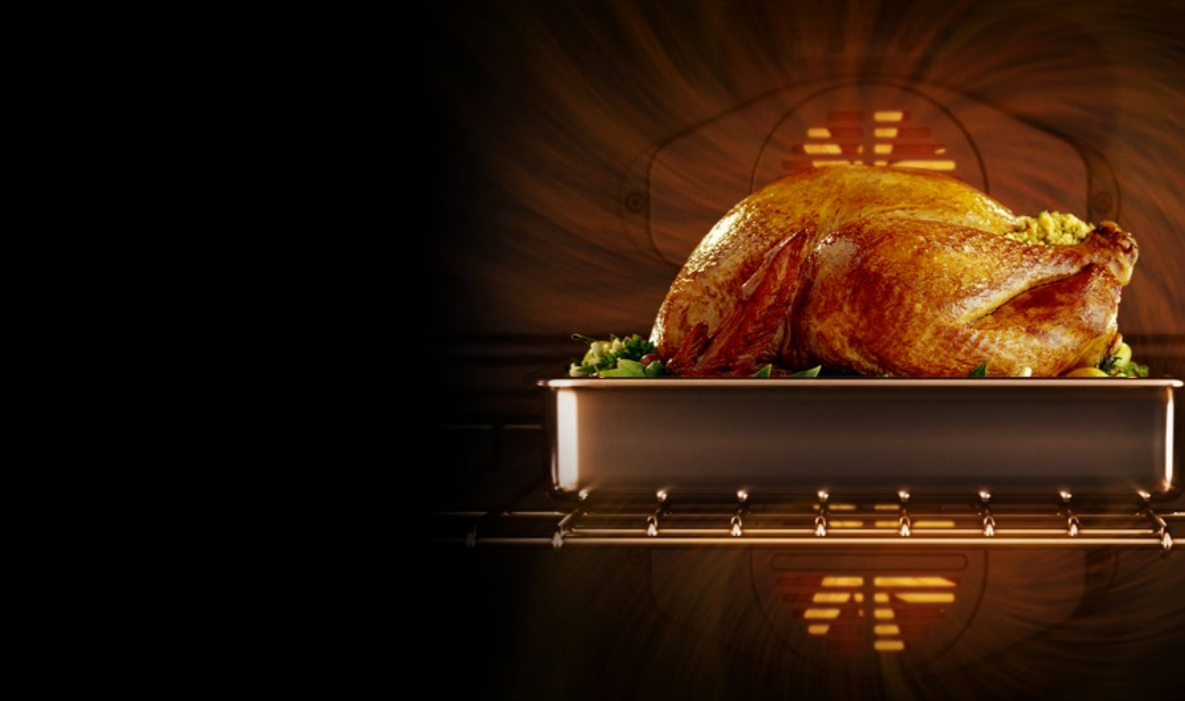
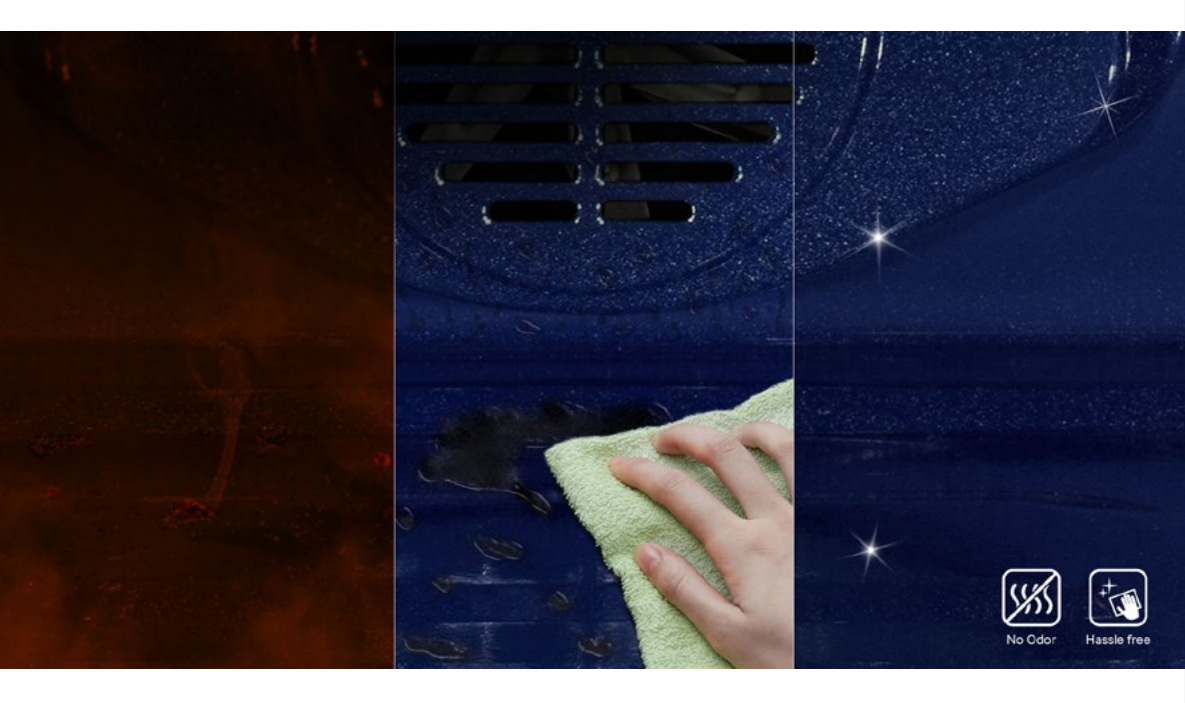
Overall Product Headline	Feature Name	Long Body Copy	Short Body Copy	Associated Image
<p>Fast cooking</p>	<p>Dual Convection</p>	<p>Save time and cook food more evenly with dual convection. Great for baking, roasting, and broiling, the dual convection system has two heated fans that distribute heat throughout the oven and keep temperature constant everywhere.</p>	<p>Great for baking, roasting, and broiling, the dual convection system has two heated fans that distribute heat throughout the oven and keep temperature constant everywhere.</p>	
<p>Does the hard work for you</p>	<p>Self and Steam Clean</p>	<p>Get help from your oven with Self Clean. The self-cleaning system deep cleans by heating to a high temperature to burn off grease and food residue. Steam Clean in 20 minutes for easier cleaning jobs.</p>	<p>Get help from your oven with Self and Steam Clean.</p>	

Product Videos



Full Video

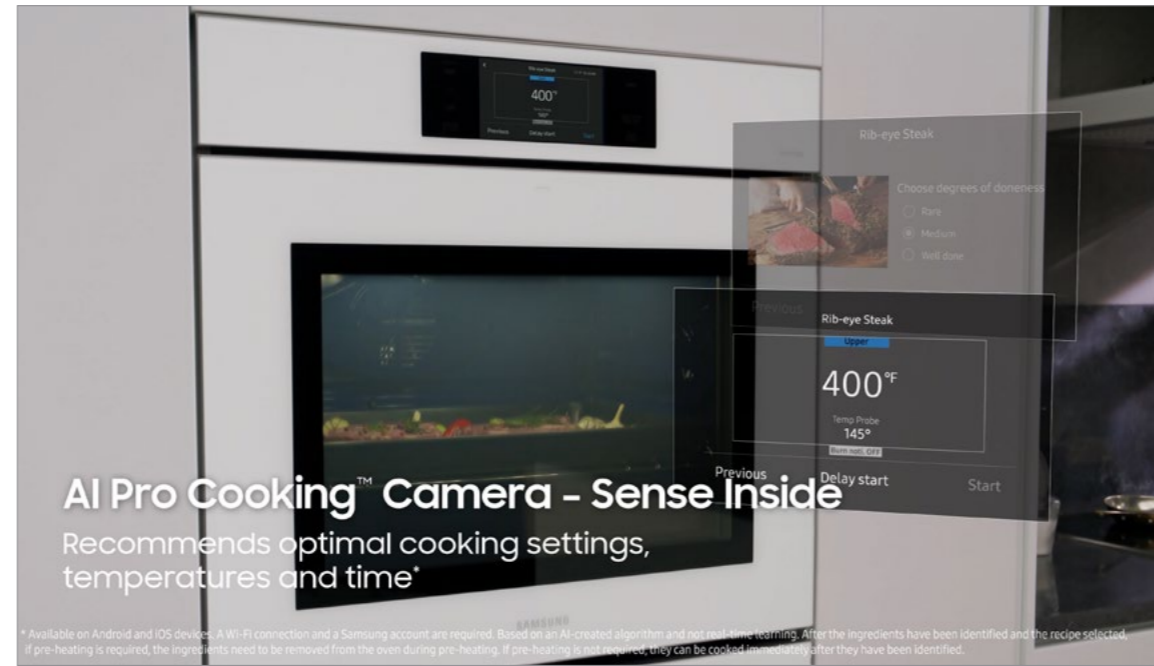

AI Pro Cooking Camera

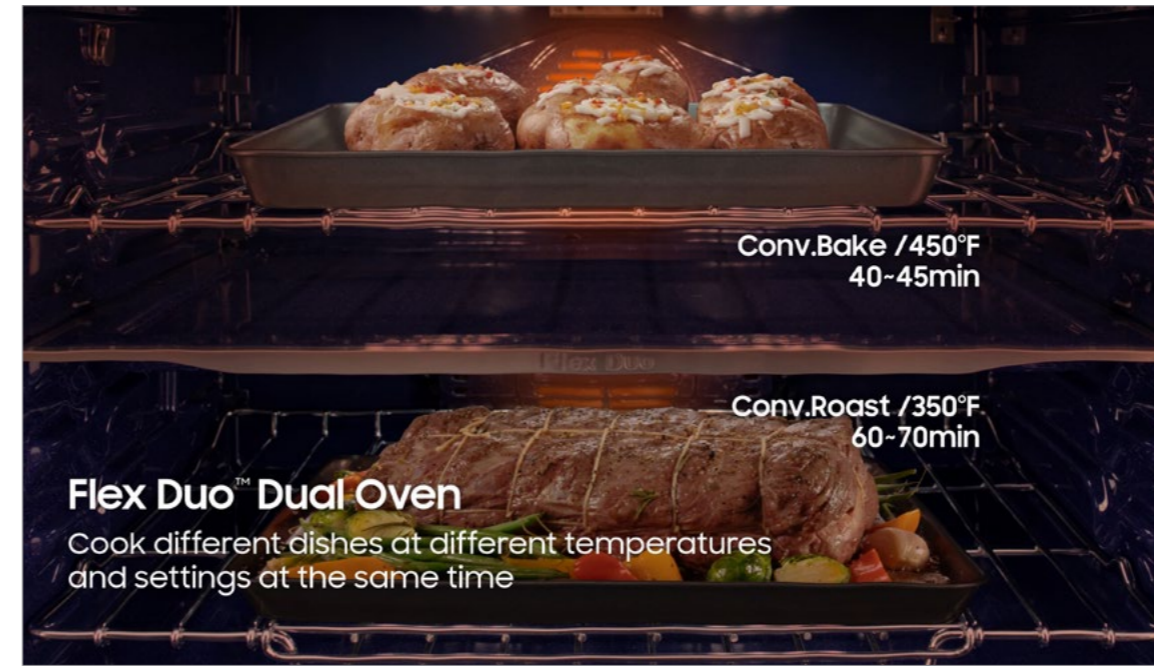

Flex Duo



Air Sous Vide



SmartThings Cooking



Steam Cook

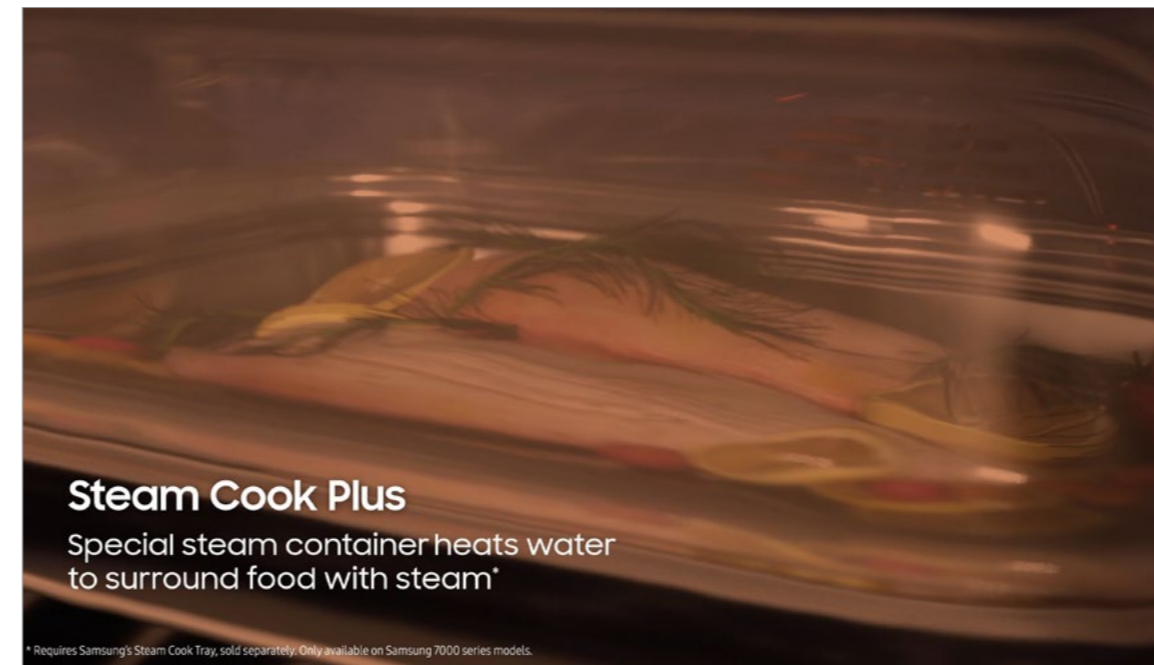

Stam Cook Plus



Self Clean

Primary Lifestyle Image

For use on marketing landing pages , category pages and offsite landing pages.



Bespoke White Glass (Preferred image for marketing usage.)



Bespoke Stainless Steel



Bespoke Matte Black Steel

Additional Lifestyle Image



Bespoke White Glass (Preferred image for marketing usage.)



Bespoke Matte Black Steel



Bespoke Stainless Steel



Bespoke White Glass

Fact Tag Guidance

Please follow one of the below naming conventions for fact tags at retail, accounting for any potential character count limitations. Please also ensure that any feature list appearing on fact tags follows the Product Messaging hierarchy and copy noted in the Product Guide for each model.

Long (More than 50 Characters)

Bespoke 30" Double Wall Oven with AI Pro Cooking™ Camera

Medium (50 Characters or less)

Bespoke 30" Double Wall Oven

Short (35 Characters or less)

Double Wall Oven

Product Specs

NV51700D – Bespoke 30" Double Wall Oven
with AI Pro Cooking™ Camera**

Spec Sheet

NV51C*700D

Bespoke 30" Double Wall Oven



SAMSUNG

Available Colors

- Stainless Steel**
NV51CG700DSR
- Matte Black**
NV51CG700DMT
- White Glass**
NV51CB700D12

Design

- Push to Open
- Full Glass Door
- Drop-Down Door Design
- Modern Design

Convenience

- Sabbath Mode
- Delay Start
- Child Safety Lock
- Warming Mode
- Kitchen Timer

Features

- AI Pro Cooking™ Camera:
 - Monitor food
 - Recognize ingredients
 - Record time lapse videos
- Flex Duo™
- Air Sous Vide
- Air Fry, Tray Included
- Steam Cook Plus
- Convection Vegetable
- Steam Cook
- 7-Inch LCD Display
- Digital Touch Controls
- Wi-Fi Connectivity
- Dual Convection
- Guided Cook
- Steam Clean & Self-Clean
- LED Lights
- 2 Heavy-Duty Racks
- Gliding Rack
- Broil Element
- 6 Rack Positions

Dimensions

Product Dimensions & Weight (WxHxD)
Outside (Max) Wall Oven Dimensions:
 29 1/4" x 51 1/2" x 24 1/8"
Wall Oven Cut-Out Dimensions:
 28 1/2" x 50 1/4" x 23 1/2"
 Weight: 302 lbs

Shipping Dimensions & Weight (WxHxD)
 Dimensions: 33 1/4" x 56 1/8" x 29 13/16"
 Weight: 330.7 lbs

Warranty
 One (1) Year All Parts and Labor

UPC

Double Wall Oven	Model #	UPC Code
Stainless Steel	NV51CG700DSR	887276757704
Matte Black	NV51CG700DMT	887276757698
White Glass	NV51CB700D12	887276757636

Spec Sheet - front

NV51C*700D

30" Double Wall Oven

Product Dimensions

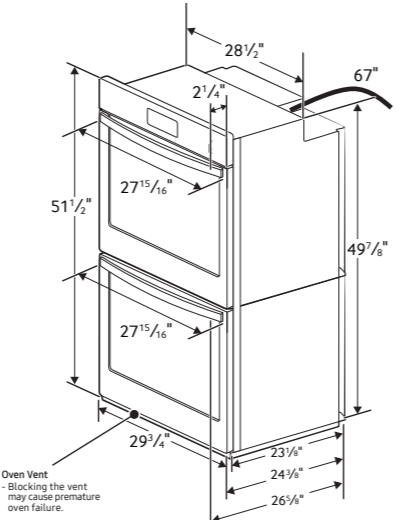

SAMSUNG

Electrical Requirements

KW RATING	
240V	10.6 kW
208V	8.0 kW

BREAKER SIZE	
240V	50 Amps
208V	40 Amps

Cabinet Dimensions

Double Oven Installed in Cabinet

* Junction Box

** Allow a minimum of 22" for clearance to adjacent corners, drawers, walls, etc. when door is open.

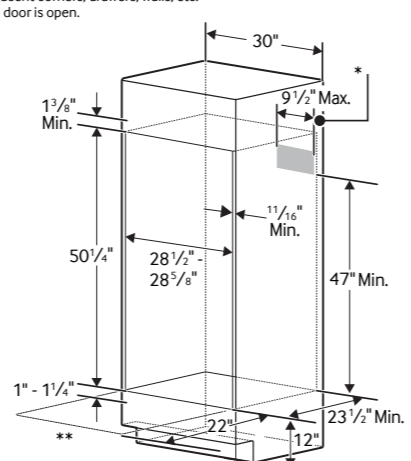

Actual color may vary. Design, specifications, and color availability are subject to change without notice. Non-metric weights and measurements are approximate.
 ©2023 Samsung Electronics America, Inc. 85 Challenger Road, Ridgefield Park, NJ 07660. Tel: 800-SAMSUNG, samsung.com. Samsung is a registered trademark of Samsung Electronics Co. Ltd.

Spec Sheet - back

Oven: Overview | Messaging | Specs | Icons

Samsung proprietary and confidential

User Manuals and Warranty Information



User Manual

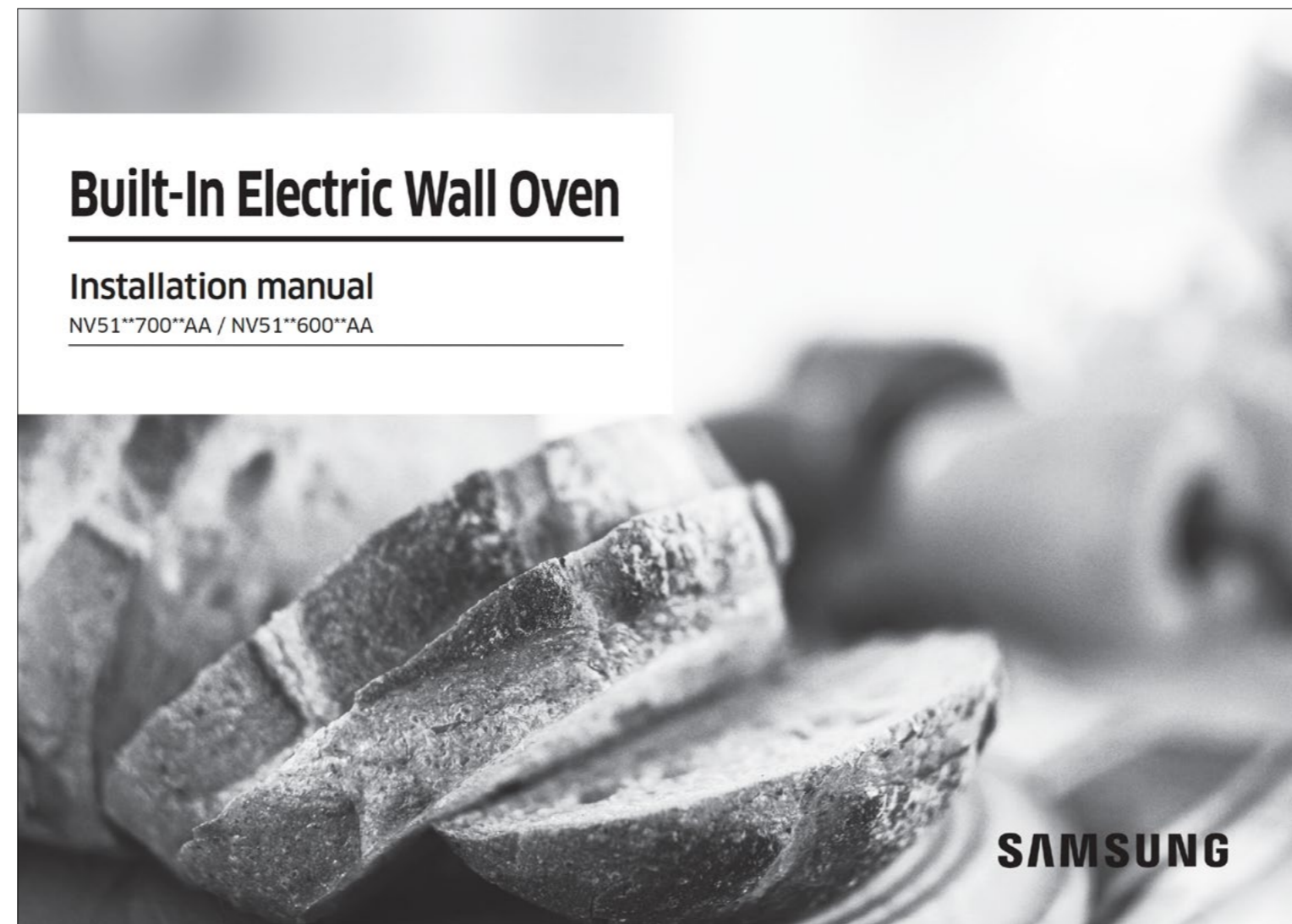

Installation Manual

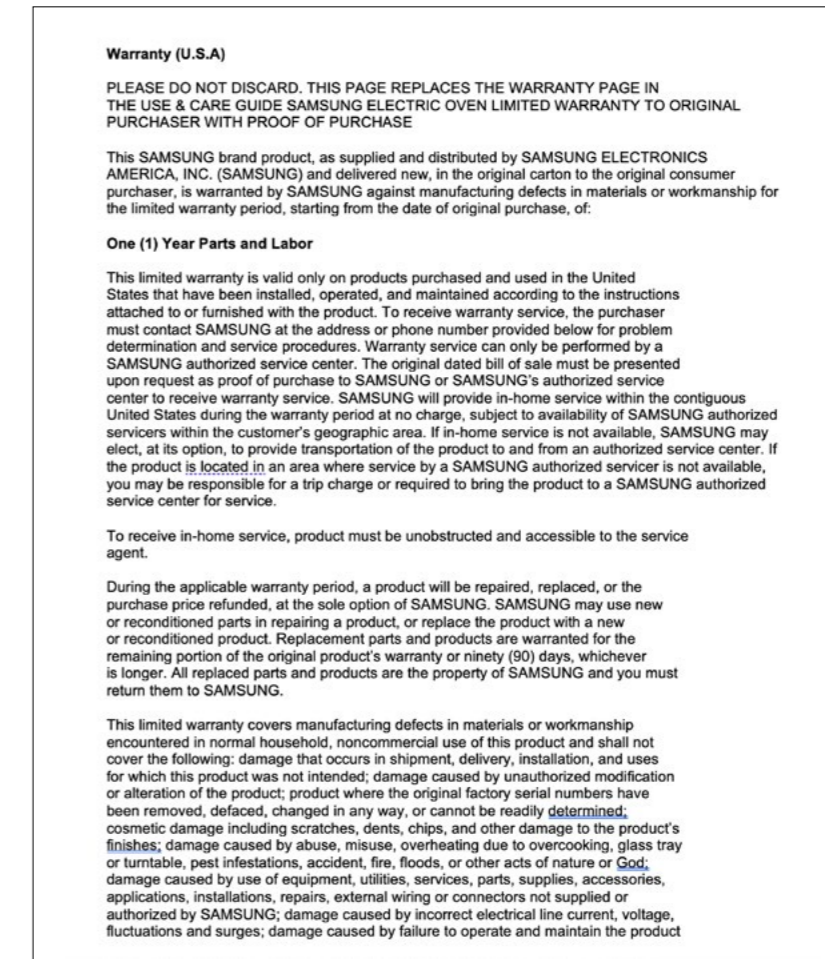

Manufacturer Warranty

Feature Icons

NV51700D – Bespoke 30" Double Wall Oven
with AI Pro Cooking™ Camera**

Feature Icons



AI Pro Cooking™
Camera



Handle-Free
Oven Design

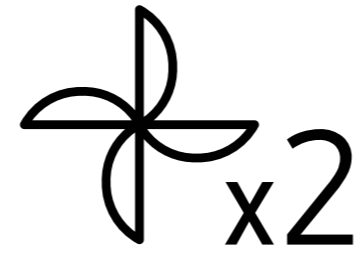

Dual Convection
Oven



Self + Steam Clean

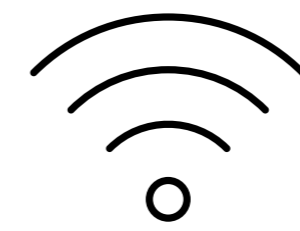

Wi-Fi Connectivity

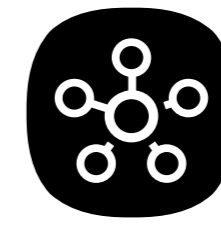

SmartThings

SAMSUNG