

# ROKU®

## Pro Series TV Wall Mount Kit

### Installation Guide

Mount your Roku Pro Series TV flush against the wall like a work of art.

- Wall bracket is hinged to easily access the back of the TV while mounted.
- Kickstands support TV away from the wall for access to cables and inputs.



For setup help visit  
[go.roku.com/TVmount](https://www.roku.com/TVmount)

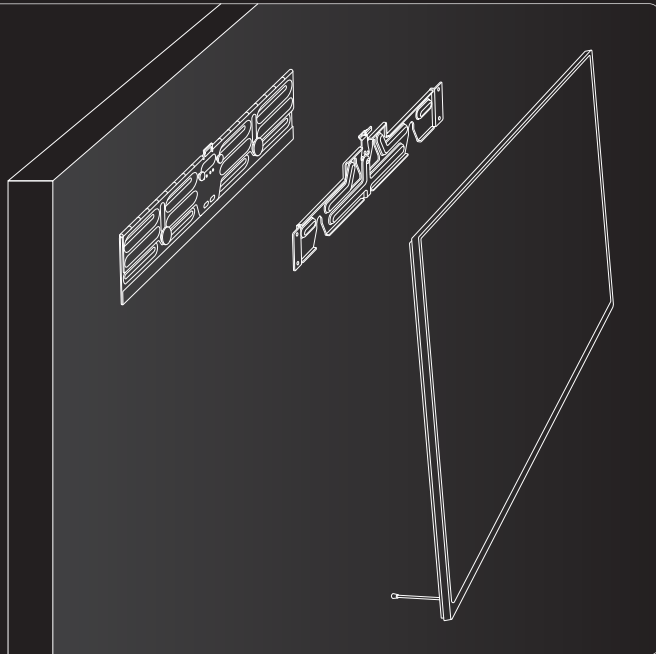

## Important safety instructions

- Read these instructions. Keep these instructions. Heed all warnings. Follow all instructions.
  - If you have not fully read and understood these instructions, do not attempt to install the product. If you do not fully understand these instructions, contact a specialized installer to install the product for you.
- ⚠** This is the safety alert symbol. It is used to alert you to potential personal injury hazards. Obey all safety messages that follow this symbol to avoid possible injury or death.
- ⚠ WARNING:** Indicates a hazardous situation which, if not avoided, could result in death, serious injury and property damage.
- ⚠ CAUTION:** Indicates a hazardous situation which, if not avoided, could result in minor or moderate injury or property damage.
- IMPORTANT:** Addresses practices which could result in property damage or other risk.

**⚠ WARNING:** The wall mount and TV can be damaged by external shock, so please handle it with care. Before starting assembly, review the parts list below and verify that all parts are included and undamaged. If any parts are missing or damaged, do not return the damaged item to your dealer; contact Customer Service. Do not use damaged parts.

**⚠ WARNING:** Do not use the product for purposes other than mounting a TV on the wall. Only use this product with TV models specified by the manufacturer.

**⚠ WARNING:** This product includes small parts and cables that may present a choking hazard to young children, and the packaging may cause suffocation. Always keep the parts and packaging out of the reach of young children.

**⚠ WARNING:** Use a trained and experienced installer to move or replace the wall mount, if needed. Reinstallation requires special techniques. Moving or reinstalling the product on your own can cause serious safety issues.

**⚠ CAUTION:** When installing/using the wall mount, be careful with tools and avoid accidents.

This mount has been tested to support Roku Pro Series TV models 55R8BX, 65R8BX and 75R8BX, with a maximum weight limit of 85 lbs.

## What's included

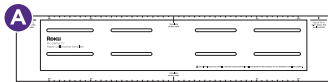

Paper wall bracket template



Hinged wall bracket



TV bracket



Lag bolts (x4)



Concrete wall anchors (x4)



TV bracket screws (x6)

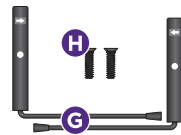

Kickstands and screw (x2)



10mm nut driver



Alignment flags (x2)

Not all hardware included in this kit may be used.

## STEP 1: Plan TV placement

### What you'll need for this step

- Cardboard TV placement guide
- Pencil
- Painter's tape
- Stud finder

**⚠ WARNING:** Read carefully before you mount your TV.

### Determine what your wall is made of

#### ✓ Drywall with wood studs

- Minimum wood stud size: nominal (2 x 4"), actual (1.5 x 3.5").
- The minimum distance between studs cannot be less than 16".
- Drywall covering the wall must not exceed 5/8".

#### ✓ Solid concrete or concrete block

- Minimum solid concrete thickness: 8".
- Minimum concrete block size: 8 x 8 x 16".

#### ✗ Drywall alone

- Do not attempt to mount on a wall constructed from anything other than the types listed above.

1. Find the cardboard TV placement guide from your Roku Pro Series TV packaging. If you don't have the original TV package, proceed to Step 2: Prepare your wall.
2. Hold the cardboard TV placement guide up to your wall to determine where to place your TV and tape it in place.

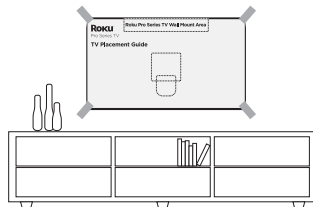

**Tip:** TV should be at eye level from wherever you plan to view.

3. If you have a wood stud wall, use your stud finder to find two studs that fall within the mounting area marked on the guide. You may have to adjust the placement guide until it's aligned with the studs.

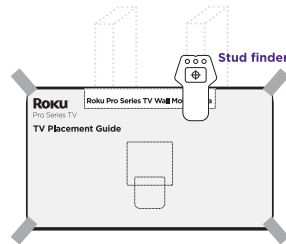

4. Use a pencil to mark the wall at the top center of the placement guide.
5. Take the cardboard placement guide off the wall. You're now ready to prep your wall for mounting.

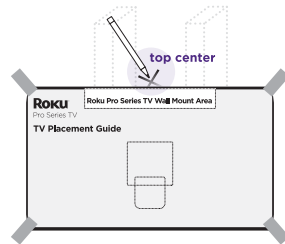

**⚠ WARNING:** Do not attempt to mount on a cinder block wall.

**⚠ WARNING:** Do not attempt to mount on drywall alone or on walls made from plasterboard or medium density fiberboard (MDF). The wall mount lag bolts must be secured to a wood stud or concrete.

**⚠ WARNING:** Install the product only on a vertical wall.

**⚠ WARNING:** The wall must be capable of supporting five times the weight of the TV and mount combined.

**⚠ WARNING:** Do not install the product near any object that may cause vibration or near any high voltage power cable or power source.

## STEP 2: Prepare your wall

### What you'll need for this step

- A** Paper wall bracket template
- B** Hinged wall bracket
- D** Lag bolts (x4)
- I** 10mm nut driver

- Pencil
- Electric drill
- Level

- 10mm socket
- Socket wrench

### For drywall with wood studs

- Stud finder
- 5/32" drill bit

### For concrete wall

- E** Concrete wall anchors (x4)
- 3/8" concrete drill bit
- Hammer

### For wood stud wall

1. Locate two studs in your wall using your stud finder.
2. Mark the center of the stud with a vertical line.

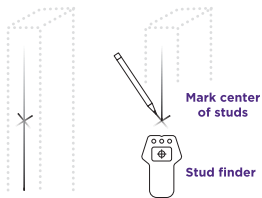

**Tip:** If you're using a magnetic stud finder, it should find the sheetrock nail in the center of the stud.

**Tip:** If you're using an electronic stud finder, you will have to find the edges of the stud, then mark the center.

3. Place the paper wall bracket template over your marked lines and align the center of the template. If you marked a center line in Step 1, make sure the center of the template is aligned with your marked line.
4. Adjust to your desired height. Make sure the template is level.

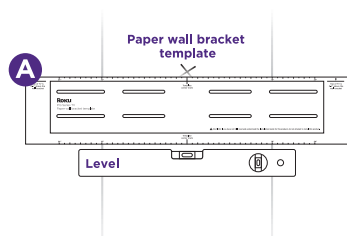

5. Use a screwdriver or tip of a screw to make four indentations where you want to begin drilling. Remove the template.
6. Drill four holes to a depth of 3" using the 5/32" drill bit.

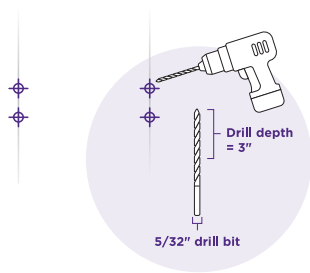

7. Align the hinged wall bracket slots with the drilled holes and insert the lag bolts.
8. Use 10mm nut driver to loosely tighten the lag bolts through the slots until the hinged wall bracket is flush with the wall.

**IMPORTANT:** Make sure the hinged wall bracket is level once more before tightening the lag bolts with a socket wrench and 10mm socket. Do not overtighten.



**Tip:** Hold the hinged wall bracket in place while tightening the lag bolts to avoid shifting.

**10mm nut driver**

## For solid concrete or concrete block wall

1. Level the hinged wall bracket template at your desired height and mark with a pencil where you'll drill your holes.

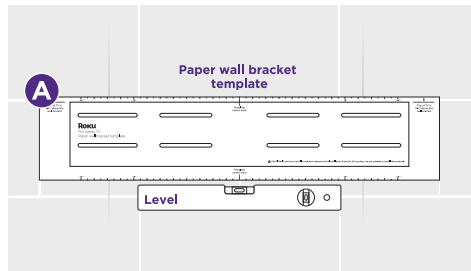

**⚠ WARNING:** If drilling into concrete block, do not drill into the mortar between blocks.

2. Remove the template. Drill four holes to a depth of 3" using the 3/8" drill bit.
3. Hammer the concrete bolt anchors into the holes.

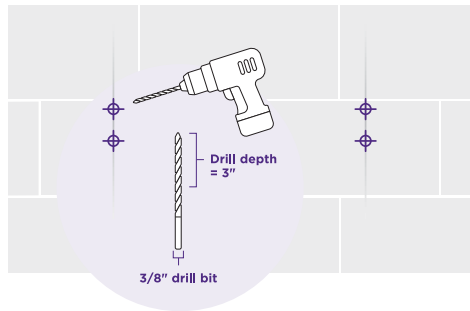

4. Align the hinged wall bracket slots with the drilled holes and insert the lag bolts into the concrete anchors.
5. Use 10mm nut driver to loosely tighten the lag bolts through the slots until the hinged wall bracket is flush with the wall.

**IMPORTANT:** Make sure the hinged wall bracket is level once more before tightening the lag bolts with a socket wrench and 10mm socket. Do not overtighten.

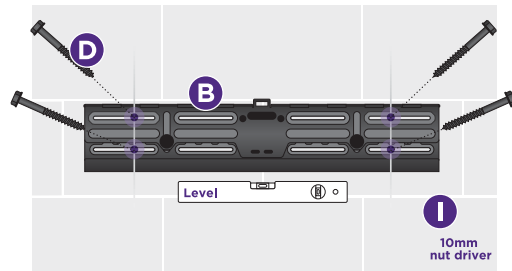

**Tip:** Hold the hinged wall bracket in place while tightening the lag bolts to avoid shifting.

## STEP 3: Prepare TV for mounting

### What you'll need for this step

- |                         |                                |                                    |
|-------------------------|--------------------------------|------------------------------------|
| <b>C</b> TV bracket     | <b>G</b> Kickstands (x2)       | • Phillips screwdriver             |
| <b>F</b> TV screws (x6) | <b>H</b> Kickstand screws (x2) | • Power cable and any other cables |

**IMPORTANT:** To avoid damage, place the TV face down on a blanket or soft surface large enough to support the entire TV.

### Attach TV bracket

1. Center the TV bracket in the bracket recess.
2. Secure the bracket to the TV with included screws.

### Install kickstands

1. Locate the slots at the bottom of the TV.
2. Slide the kickstands into the slots and secure with included screws.
3. Leave kickstands in retracted position.

### Connect cables

1. Plug the power cable and any other cables you'd like to connect into the TV. Do not plug cables into an outlet yet.

**IMPORTANT:** Use cable straps to secure cables and avoid tripping.

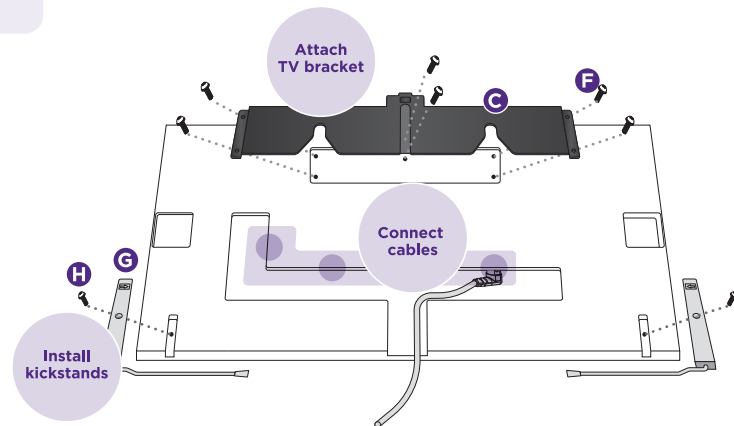

**⚠ CAUTION:** Do not use a power screwdriver or drill for this step.

**⚠ WARNING:** Make sure there are adequate threads to secure the bracket to your TV. If you encounter resistance, stop immediately and contact customer service.

## STEP 4: Hang the TV

### What you'll need for this step

- 1 Alignment flags (x2)

**⚠ WARNING:** You will need assistance with this step. Do not attempt to hang the TV by yourself.

1. Adhere the alignment flags.

- Peel the long alignment flag and apply it to the wall behind the lock slot at the top center of installed hinged wall bracket.
- Peel the shorter installation flag and apply it to the TV back cover in front of the lock at the top center of the installed TV bracket.

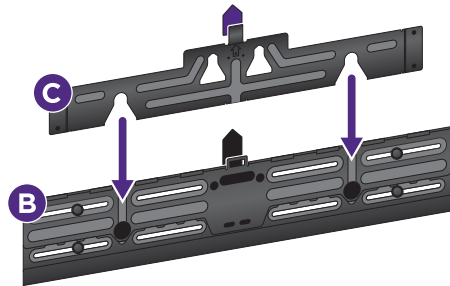
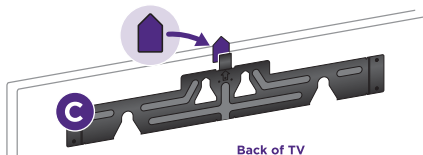
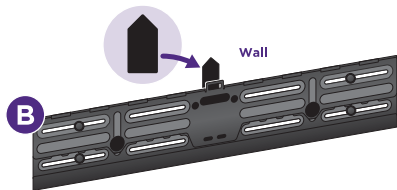

2. Using the installation flags as guidance, position the TV bracket directly above the hinged wall bracket so the tops of the flags overlap.
3. Gently lower the bottom of the TV against the wall. Once your TV is mounted properly, you're ready to set up your TV. Refer to your Roku Pro Series TV Quick Start Guide for instructions. Power on!

**IMPORTANT:** The TV must click into place. If you do not hear the click, readjust and try again.

**⚠ CAUTION:** Avoid personal injury and property damage by making sure the TV is always locked securely into the hinged wall bracket.

**⚠ WARNING:** Do not allow the power cord or cables to be pinched or trapped while hanging the TV.

## Using your wall mount

### Accessing cables

1. Pull the bottom of the TV away from the wall.
2. Fold out the kickstands and gently rest them against the wall so the bottom of the TV is propped away from the wall.
3. Manage your cables.
4. Retract the kickstands and gently lower the bottom of the TV against the wall.

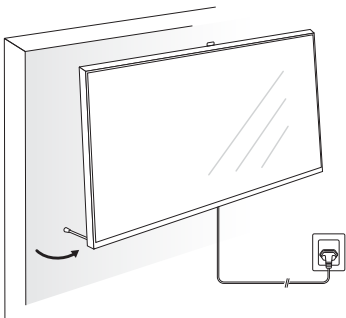

### Removing the TV

1. Unplug all cables.
2. Retract the kickstands and gently return the TV to resting position.
3. Locate the lock at the top center of the TV bracket.
4. Pull the lock back and gently lift the TV away from the wall. The TV will need to be lifted straight up about 1".

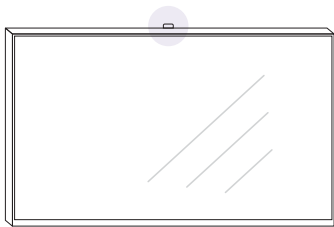

Front of TV

Release lever is located behind the top of TV

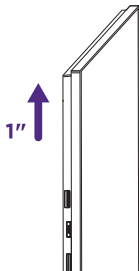

Side of TV

Lift up 1" and then pull away from the wall

**WARNING:** You will need assistance with this step. Do not attempt to remove the TV by yourself.

## Need help?

For setup help or support, visit or call

[go.roku.com/TVmount](https://go.roku.com/TVmount)

**1-816-272-8106**

4:00 am - 8:00 pm PT



Copyright © 2024 Roku, Inc. All rights reserved. Roku and the Roku logo are trademarks or registered trademarks of Roku, Inc.

4100001072\_2