

ASSEMBLY INSTRUCTIONS
COASTER FINE FURNITURE

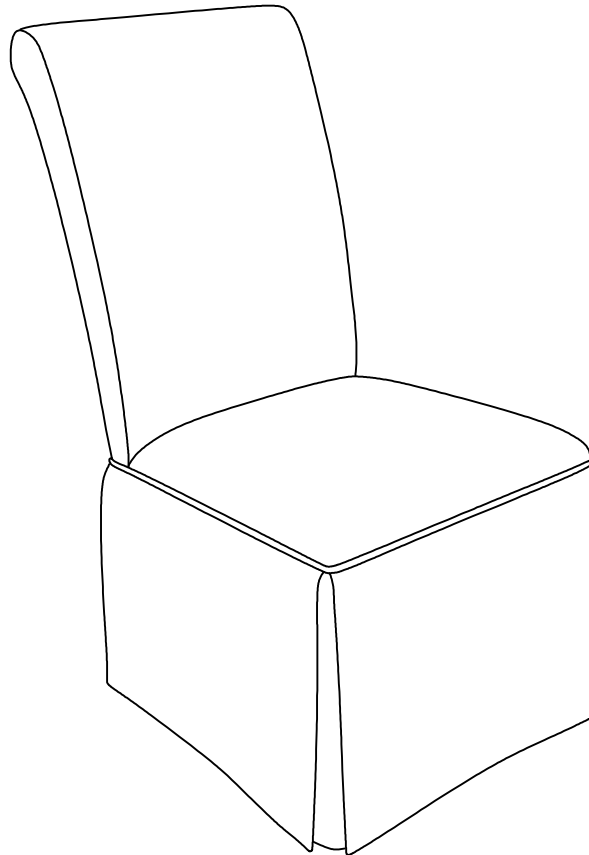

Fine Furniture for every stage of life

100748
Parson Chair

ITEM:100748



ASSEMBLY INSTRUCTIONS

ASSEMBLY TIPS:

1. Remove hardware from box and sort by size.
2. Please check to see that all hardware and parts are present prior to start of assembly.
3. Please follow attached instructions in the same sequence as numbered to assure fast & easy assembly.



WARNING!

1. Don't attempt to repair or modify parts that are broken or defective. Please contact the store immediately.
2. This product is for home use only and not intended for commercial establishments.





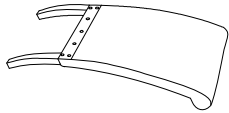
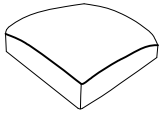
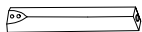

ASSEMBLY TIME

10 MINUTES

PARTS IDENTIFICATION

- A CHAIR BACK  1PC
- B SEAT  1PC
- C FRONT LEG  2PCS

Z HARDWARE IDENTIFICATION

NO	DESCRIPTION	FIGURE	Q' TY
1	LOCK WASHER 5/16"		10PCS
2	FLAT WASHER 5/16"		10PCS
3	BOLT 5/16X2"		2PCS
4	BOLT 5/16X2-1/2"		4PCS
5	BOLT 5/16X3-1/2"		4PCS
6	ALLEN KEY 5mm		1PC
7	WOOD DOWEL		1PC

NOTE:

Quantities shown are for one chair.

ITEM:100748

ASSEMBLY INSTRUCTIONS

STEP: 1

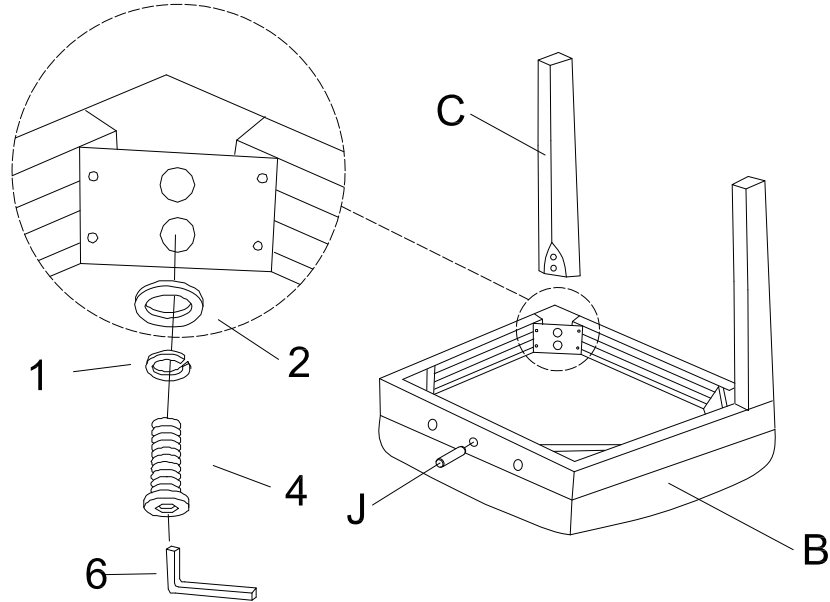

STEP: 2

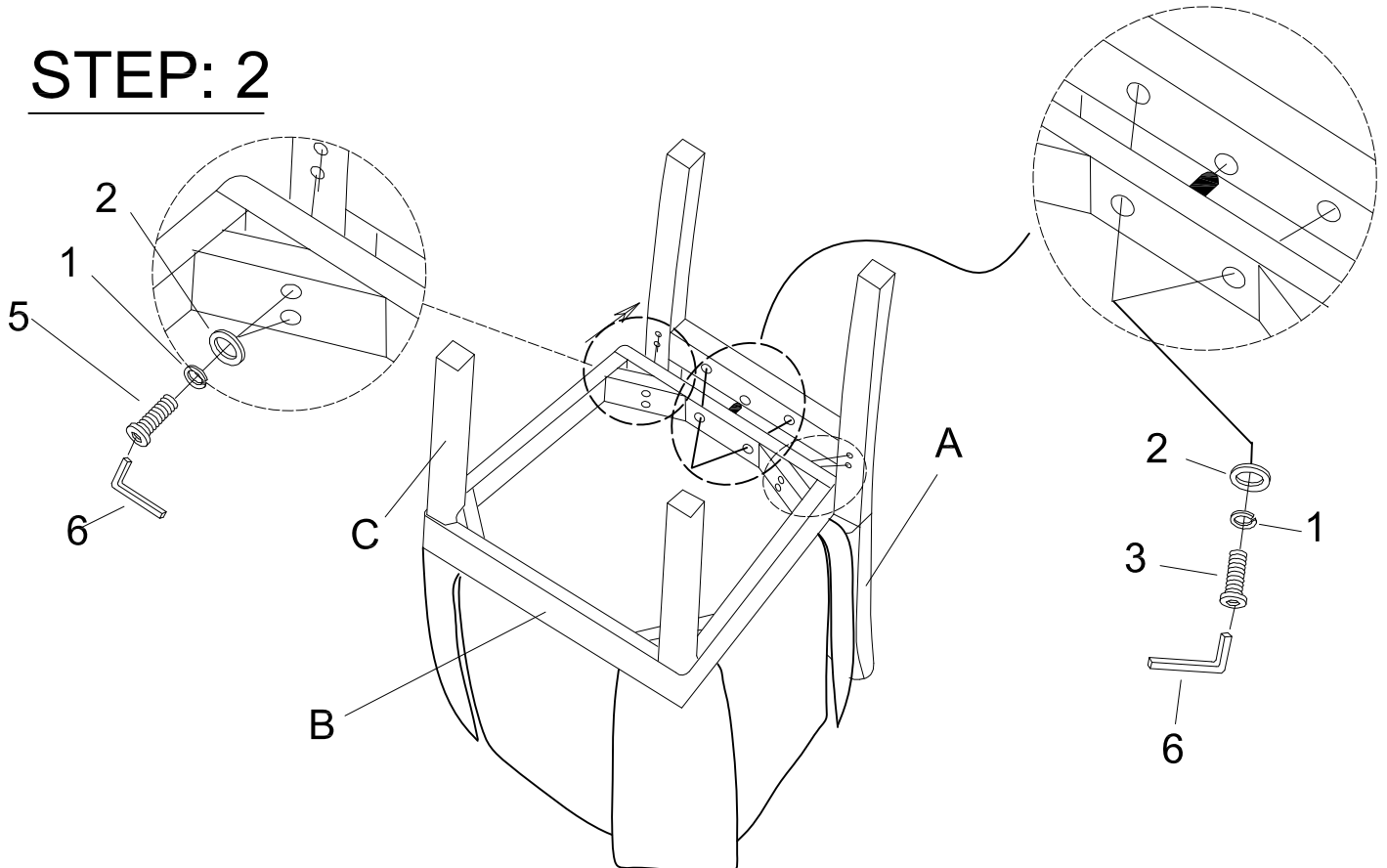

ITEM:100748



ASSEMBLY INSTRUCTIONS

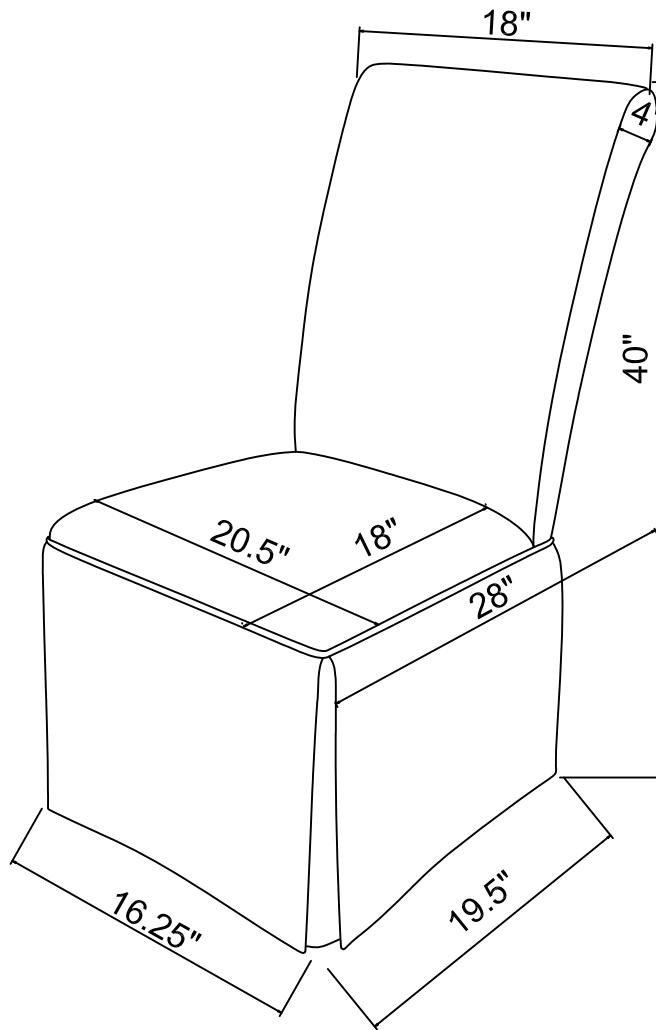

Note: Dimension tolerance $\pm 5\%$