



CLEANVIEW XR® (PET)
POWERLIFTER™ TURBO (PET)
STICK VACUUM
 SERIES 3789, 3797

Important Safety Instructions..... 2
 Assembly 3
 Charging the Battery..... 4
 Using Your Vacuum..... 5
 Attaching Tools for Hand Vac Use..... 5
 Emptying the Dirt Tank..... 6
 Cleaning & Replacing the Filter..... 6
 Maintaining the Brush Roll..... 7
 Troubleshooting..... 8
 Warranty..... 8

Product Overview

- | | |
|-----------------------------|------------------------|
| 1. Hand Vacuum Assembly | 8. Extension Wand |
| 2. Power Trigger | 9. Foot Release Button |
| 3. Battery | 10. Motorized Foot |
| 4. Battery Release Button | 11. Brush Roll Release |
| 5. Dirt Tank Release Button | |
| 6. Dirt Tank Lid Button | |
| 7. Wand Release Button | |

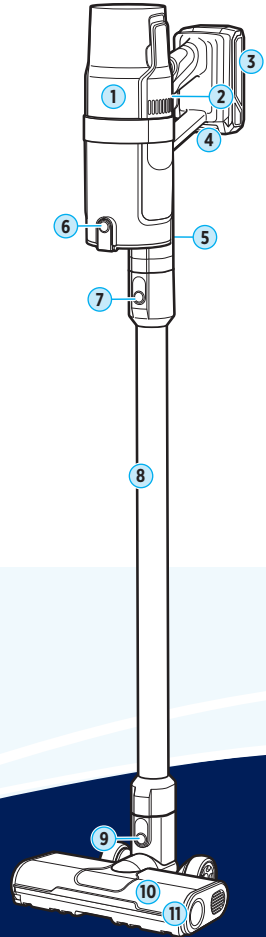

Meet your new BISSELL® product!

Go to support.BISSELL.com for a walkthrough of your new purchase, including videos, tips, support, and more. Want to get started right away? This guide has all the information you need to set up your new product. Let's take a look...

IMPORTANT SAFETY INSTRUCTIONS



READ ALL INSTRUCTIONS BEFORE USING YOUR APPLIANCE.

When using an electrical appliance, basic precautions should be observed, including the following:



WARNING

TO REDUCE THE RISK OF FIRE, ELECTRIC SHOCK OR INJURY:

- Risk of injury from moving parts. Brush may start unexpectedly. Turn OFF before cleaning or servicing.
- Do not charge the battery outdoors.
- Do not dismantle, open or shred battery pack. Do not subject battery pack to mechanical shock. Dispose of used batteries promptly and properly.
- Do not turn your vacuum ON until you are familiar with all instructions and operating procedures.
- If the vacuum is to be stored unused for a long period, the batteries should be removed.
- Do not remove battery from its original packaging until required for use.
- The battery must be removed from the appliance before it is scrapped.
- Dispose of used batteries promptly.
- The battery is to be disposed of safely.
- Keep appliance on a level surface.
- Do not use appliance in an enclosed space filled with vapors given off by oil-based paint, paint thinner, some moth-proofing substances, flammable dust, or other explosive or toxic vapors.
- Do not use to pick up toxic material (chlorine bleach, ammonia, drain cleaner, etc.)
- Do not pick up hard or sharp objects such as glass, nails, screws, coins, etc.
- Plastic film can be dangerous. To avoid danger of suffocation, keep away from children.
- Do not use the appliance outdoors or on wet surfaces.
- Do not charge the appliance outdoors.
- Do not allow appliances to be used as a toy. Paying close attention is necessary when used by or near children.
- Use only as described in this manual. Use only manufacturer's recommended attachments.
- Do not handle the battery or the appliance with wet hands.
- Do not put any object into openings. Do not use with any opening blocked; keep free of dust, lint, hair, and anything that may reduce air flow.
- Keep hair, loose clothing, fingers and all body parts away from openings and moving parts.
- Use extra care when cleaning on stairs.
- Do not use to pick up flammable or combustible liquids, such as petroleum, or use in areas where they may be present.
- Never allow children to operate the appliance. Adults should not operate the appliance without proper instruction.
- Do not use appliance that is damaged or modified. Damaged or modified batteries may exhibit unpredictable behavior resulting in fire, explosion or risk of injury.
- Do not use to pick up flammable or combustible liquids, such as gasoline, or use in areas where they may be present.
- Do not pick up anything that is burning or smoking, such as cigarettes, matches, or hot ashes.
- Do not use without dirt tank, filter in place (if applicable).
- Do not use charger with damaged cord or plug. If appliance is not working as it should, has been dropped, damaged, left outdoors, or dropped into water, return it to a service center.
- Do not pull or carry charger by cable, use cable as a handle, close door on cable, or pull cable around sharp edges or corners.
- Keep charger cable away from heated surfaces.
- Turn off all controls before removing the battery pack.
- Always turn off this appliance before connecting or disconnecting either accessories.
- To reduce the risk of fire or electric shock, use appliance only with BISSELL® identical parts and charger cords. If cord is damaged or lost, replace with identical replacement part.
- Follow all charging instructions and do not charge the battery pack or appliance outside of the temperature range specific in the instructions. Charging improperly or at temperatures outside of the specific range may

damage the battery and increase the risk of fire.

- Do not modify or attempt to repair the appliance or the battery pack (as applicable) except as indicated in the instructions for use and care.
 - Prevent unintentional starting. Ensure the switch is in the off-position before connecting to battery pack, picking up or carrying the appliance. Carry the appliance with your finger on the switch or energize appliance that have the switch on invites accidents.
 - Recharge only with the charger specified by the manufacturer. A charger that is suitable for one type of battery pack may create a risk of fire when used with another battery pack.
 - Use only the charger supplied by the manufacturer to recharge: CAM811
 - Use appliances only with specifically designated battery packs. Use of any other battery packs may create a risk of injury and fire.
 - Disconnect the battery pack from the appliance before making any adjustments, changing accessories, or storing the appliance. Such preventive safety measures reduce the risk of starting the appliance accidentally.
 - When battery pack is not in use, keep it away from other metal objects like paper clips, coins, keys, nails, screws or other small metal objects that can make a connection from one terminal to another. Shorting the battery terminals together may cause burns or a fire.
 - Under abusive conditions, liquid may be ejected from the battery; avoid contact. If contact accidentally occurs, flush with water. If liquid contacts eyes, immediately seek medical attention. Liquid ejected from the battery may cause irritation or burns.
 - Do not incinerate the appliance even if it is severely damaged. The batteries can explode in a fire.
 - Do not use a battery pack or appliance that is damaged or modified. Damaged or modified batteries may exhibit unpredictable behavior resulting in fire, explosion or risk of injury.
 - Do not expose a battery pack or appliance to fire or excessive temperature. Exposure to fire or temperature above 265°F (130°C) may cause an explosion.
 - Unit should only be serviced by a qualified repair technician using only BISSELL replacement parts. This will prolong the life of the unit and maintain product safety.
 - Don't modify or attempt to repair the appliance or the battery pack (as applicable) except as indicated in the instructions for use and care.
 - Follow all charging instructions and do not charge the battery pack or appliance outside of the temperature range specified in the instructions. Charging improperly or at temperatures outside of the specified range may damage the battery and increase the risk of fire.
 - Do not unplug by pulling on cord. To unplug, grasp the charger, not the cord.
 - Keep battery pack or appliance out of reach of children.
 - Use only BISSELL battery pack 1638019 or 1635764.
 - Use only TEN PAO charger CAM811.
- The recommended ambient temperature range:

Item	Temperature
Vacuum storage temperature range	32°F (0°C) - 113°F (45°C)
Vacuum operation temperature range	32°F (0°C) - 113°F (45°C)
Battery charging temperature range	39°F (4°C) - 104°F (40°C)
Charger operation temperature range	39°F (4°C) - 104°F (40°C)
Battery storage temperature range	32°F (0°C) - 113°F (45°C)
Battery discharging temperature range	32°F (0°C) - 113°F (45°C)

SAVE THESE INSTRUCTIONS

THIS MODEL IS FOR HOUSEHOLD USE ONLY. COMMERCIAL USE OF THIS UNIT voids THE MANUFACTURER'S WARRANTY.

SUPPLIER'S DECLARATION OF CONFORMITY 47 CRF SECTION 2.1077 COMPLIANCE INFORMATION Charger adapter for BISSELL product. CONTACT: BISSELL Homecare Inc., 2345 Walker Ave. NW, Grand Rapids, MI 49544. This device complies with Part 15 of FCC Rules. Operation is subject to the following two conditions: (1) this device may not cause harmful interference, and (2) this device must accept any interference received, including interference that may cause undesired operation. Caution: Any changes or modifications to this unit not expressly approved by the party responsible for compliance could void the user's authority to operate the equipment. NOTE: This equipment has been tested and found to comply with the limits for a Class B digital device, pursuant to part 15 of the FCC Rules. These limits are designed to provide reasonable protection against harmful interference in a residential installation. This equipment generates, uses and can radiate radio frequency energy and, if not installed and used in accordance with the instructions, may cause harmful interference to radio communications. However, there is no guarantee that interference will not occur in a particular installation. If this equipment does cause harmful interference to radio or television reception, which can be determined by turning the equipment OFF and ON, the user is encouraged to try to correct the interference by one or more of the following measures: (1) Reorient or relocate the receiving antenna. (2) Increase the separation between the equipment and receiver. (3) Connect the equipment into an outlet on a circuit different from that to which the receiver is connected. (4) Consult the dealer or an experienced radio/TV technician for help.

WARNING

This product contains Lithium-Ion rechargeable batteries. DO NOT mix Lithium-Ion batteries with general household waste. According to Federal and State regulations, removal and proper disposal of Lithium-Ion batteries is required. For specific battery disposal instructions please contact Call2Recycle at 877-723-1297 or visit www.call2recycle.org. For full instructions on battery removal for recycling visit support.BISSELL.com.

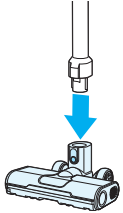
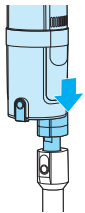
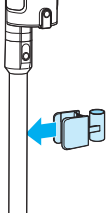
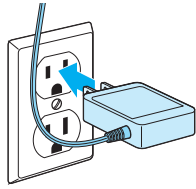

Assembly

			
<p>1. Connect the extension wand to the motorized foot until it clicks into place.</p>	<p>2. Connect the hand vacuum assembly to the extension wand until it clicks into place.</p>	<p>3. Attach tool clip to extension wand and add desired tools</p>	<p>4. Make sure to charge your stick vacuum before first use.</p>

Charging the Battery

Charging with the Charging Station

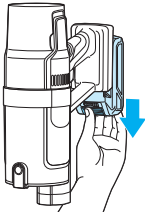

1. Turn off vacuum and press/hold battery release button to remove battery from its compartment.

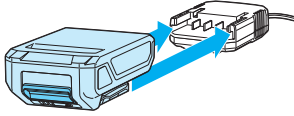

2. Slide battery into charging dock until it clicks into place.

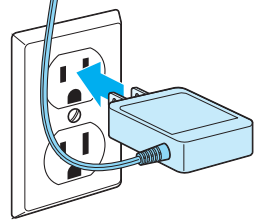

3. Plug charger into wall.

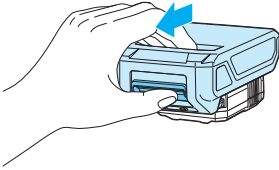

4. Slide out to remove battery from charger

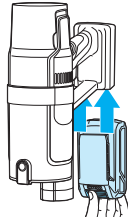

5. Align grooves on battery with grooves of battery compartment.

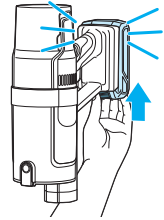

6. Guide battery into compartment until it clicks into place.

Charging with the Wall Mount & Charging Station

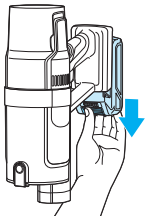

1. Turn vacuum OFF and press/hold battery release button.

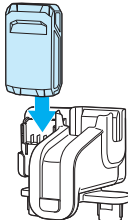

2. Insert battery into wall mount charger until it clicks.

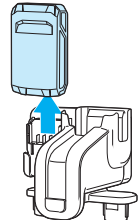

3. Lift up battery to remove from wall mount charger

Using Your Vacuum

This vacuum can be used as a stick vacuum, hand vacuum, or extended reach with a hand vacuum and wand.

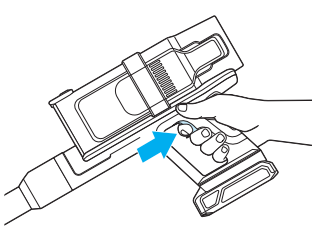

1. Press trigger to start machine. The machine starts in **Medium** mode.

Press trigger again to stop machine.

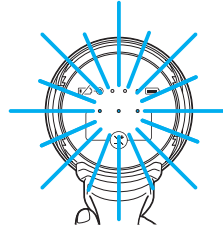

2. Press **+** or **-** on the screen to adjust the power mode. This machine has three modes.

- **Standard** For quiet operation and long runtime on hard floors
- • **Medium** For balanced power and runtime when cleaning carpet and area rugs (this is the default mode when turning on vacuum)
- • • **TURBO** For maximum suction power

Note: The run time and power of batteries vary for each model. Choose the appropriate cleaning mode for your task and surface type, as this affects run time and power. Use **TURBO** mode sparingly to preserve battery life.

Attaching Tools for Hand Vac Use

Clean stairs or furniture easily with the tools provided. Pair your desired tool with the hand vacuum or extension wand. Tools vary by model.

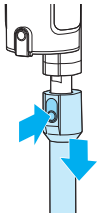

1. Turn OFF. Press release button on extension wand or accessories to remove.

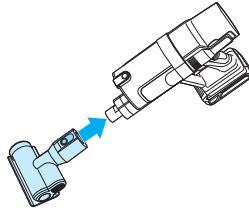

2. Attach your chosen tool.

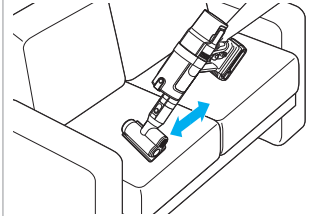

3. Use tool to clean furniture, stairs or other surfaces in your home.

Emptying the Dirt Tank

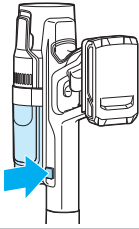

1. Power OFF. Press release button on hand vacuum to unlock the dirt tank.

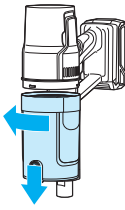

2. Twist dirt tank counterclockwise to unlock and remove.

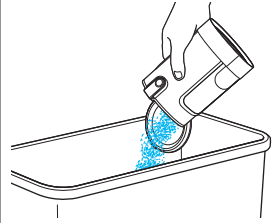

3. Press button on front of dirt tank. Dump debris into a waste basket.

Cleaning & Replacing the Filter

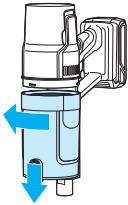

1. Power OFF. Follow steps above to remove dirt tank.



2. Use metal handle to remove filter assembly.

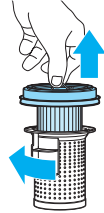

3. Twist filter cup counterclockwise to remove.

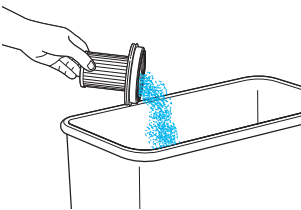

4. Tap filter against side of trash bin to remove debris.

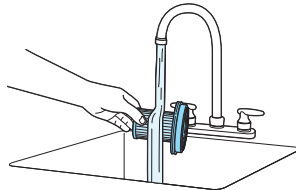

5. Rinse under warm water.



6. Let dry for 24 hours before reinstalling.

Maintaining the Brush Roll

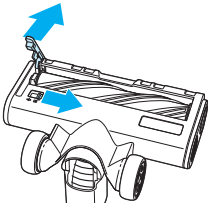

1. Power OFF. Release foot from extension wand and lay with brush roll face-up. Push foot release button on bottom of foot and lift side plate.

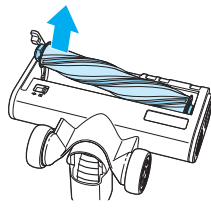

2. Remove brush roll and clear any debris.

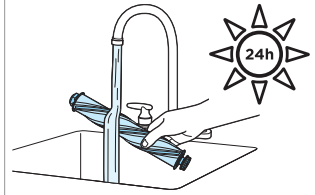

3. *Optional:* Rinse brush roll with warm water and let dry for 24 hours before reinstalling.

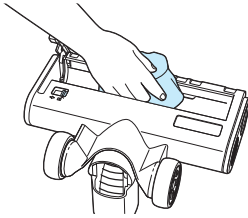

4. Wipe out brush roll chamber with a cloth.

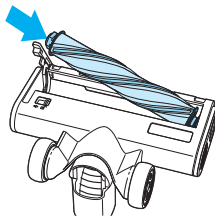

5. To reinstall brush roll, press button at end of brush roll in and guide into motorized foot.

Note: Any other maintenance or servicing not included in this manual should be performed by an authorized service representative.

Troubleshooting

Problem	Possible Cause	Remedies
Machine won't turn ON	Battery power is low.	Fully charge battery.
Dust discharges from the exhaust	Filter is damaged.	Replace filter.
	Filter is incorrectly installed.	Remove and reinstall filter.
	Filter is dirty.	Clean or replace filter.
Loss of suction	Filter is clogged.	Clean or replace filter.
	Dirt tank is full.	Empty tank.
Blinking Error Lights	Various reasons	Turn machine OFF and allow to cool before turning back on. If this does not work, contact BISSELL Support.

Warranty

Limited 2-year warranty, may vary by state. Visit support.BISSELL.com or call 1-800-237-7691 for complete warranty information.

Terms and Conditions

Your purchase is subject to the BISSELL Terms and Conditions, which includes dispute resolution through arbitration and class waiver. For complete terms or to opt out from arbitration or class waiver, visit BISSELL.com/terms-of-use or call 1-800-237-7691.

♥ Every Purchase Saves Pets™

BISSELL proudly supports BISSELL Pet Foundation® and its mission to help save homeless pets. When you buy a BISSELL® product, you help save pets, too. We're proud to design products that help make pet messes, odors and pet homelessness disappear.

Visit BISSELLsavespets.com to learn more.

