



# HERO 13 BLACK

GoPro  
■■■■

## Join the GoPro Movement



@GoPro



@GoPro



@GoPro



facebook.com/GoPro



@GoPro



pinterest.com/GoPro

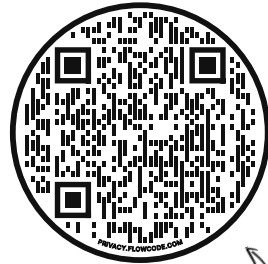

## Check Out the OOB

That's short for "Out-of-Box Experience." It's our mobile-friendly site that will help you get started with your GoPro right out of the box—from setup and recording to automatic highlight videos and saving your media.

[gopro.com/OOBE](https://gopro.com/OOBE)

## Contents

---

Meet HERO13 Black	6
Getting Started	8
Getting to Know Your GoPro	14
Getting the Shot	18
HiLight Tags	20
Screen Orientation	21
Using Easy Controls	22
Using Pro Controls	31
Pro Control Presets + Shortcuts	34
Recording Video	39
Taking Photos	45
Capturing Time Lapse	50
Live Streaming + Webcam Mode	56
Power Tools	57
Exposure Control	62
Using Voice Control	66
Pairing Your GoPro to Other Devices	69
Time Code Sync	70
Playing Back Your Media	71
Connecting to the GoPro Quik App	75
Automatic Highlight Videos	76

## Contents

---

Saving Your Media	77
Deleting Your Media	81
Setting Your Preferences	83
Important Messages	93
Resetting Your Camera	95
Mounting Your GoPro	97
Using Your GoPro in + Around Water	102
Removing the Door	103
Maintenance	105
Battery Information	106
Troubleshooting	110
Tech Specs: Video	112
Tech Specs: Photo	126
Tech Specs: Time Lapse	131
Tech Specs: Protune	137
Tech Specs: Audio	145
Customer Support	148
Trademarks	148
Regulatory Information	148

## Meet HERO13 Black

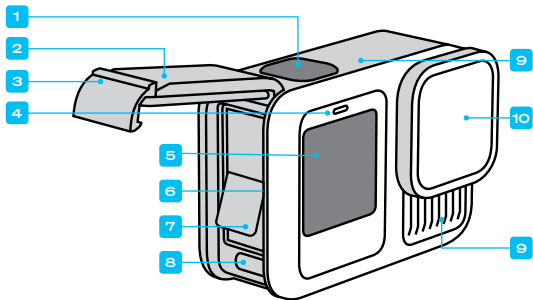

1. Shutter Button 
2. Door
3. Door Latch
4. Status Light
5. Front Screen
6. microSD™ Card Slot
7. Battery

8. USB-C Port
9. Microphone
10. Removable Lens

## Meet HERO13 Black

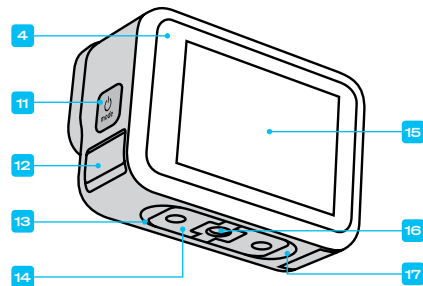

11. Mode Button 
12. Drain Microphone  
(Do not try to open.  
This is not a door/latch.)
13. Speaker
14. Folding Fingers

15. Touch Screen
16. 1/4-20 Mounting Threads
17. Magnetic Latch Mount  
Connection Point  
(Magnetic Latch Mount  
sold separately.)

Learn how to use the accessories that came with your GoPro.  
See [Mounting Your GoPro \(page 97\)](#).

## Getting Started

---

### SD CARDS

You'll need a microSD card (sold separately) to save your videos and photos. Use a brand-name card that fits these requirements:

- microSD, microSDHC™, or microSDXC™
- Rated Class A2 V30, UHS-3, or higher

For a list of recommended microSD cards, visit [gopro.com/microsdcards](https://gopro.com/microsdcards).

Be sure your hands are clean and dry before handling your SD card. Check the manufacturer's guidelines to see your card's acceptable temperature range and other important information.

*Heads Up:* SD cards can degrade over time and affect your camera's ability to save your media. Try swapping out an older card for a new one if you're having any problems.

---

**PRO TIP:** Keep your SD card in good condition by reformatting it regularly. This will erase all of your media, so be sure to save it first.

1. Swipe down on the rear screen to access the Dashboard.
2. Swipe left and tap Preferences > Reset > Format SD Card.

To learn how to save your videos and photos, see [Saving Your Media \(starting page 77\)](#).

## Getting Started

---

### RECHARGEABLE BATTERY

For maximum performance, be sure to use the Enduro battery that came with your new GoPro.

---

**PRO TIP:** There's an easy way to check your battery's status and make sure you're using the right one.

1. Swipe down on the rear screen to access the Dashboard.
2. Swipe left and tap Preferences > About > Battery Info.



**WARNING:** Although non-GoPro batteries may fit in your HERO13 Black, they could greatly limit your camera's performance. Use of non-GoPro batteries will also void your warranty and may cause fire, electric shock, or other safety risks.

For additional important information on battery safety and use, see [Battery Information \(page 106\)](#).

## Getting Started

---

### SD CARD + BATTERY SETUP

1. Make sure your GoPro is dry and clean before opening the door. Unlock the door latch and flip the door open.



*Heads Up:* The latch may be difficult to open, especially the first few times. This is to help ensure a tight waterproof seal.

2. With your camera off and battery removed, insert the SD card into the card slot with the label facing the battery compartment.

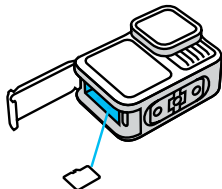

You can eject the card by pressing it into the slot with your fingernail.

## Getting Started

---

3. Insert the battery.

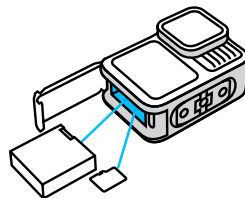

4. Connect your camera to a USB charger or computer using the included USB-C cable.

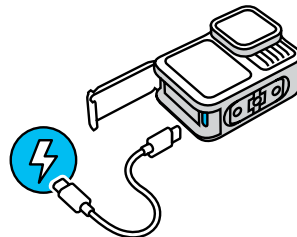

It takes about 3 hours for the battery to fully charge. The camera status light will turn off when it's done. To learn more, see [Battery Information \(page 106\)](#).

## Getting Started

---

5. Unplug the cable when charging is complete. Be sure the seal is free of debris. Use a cloth to clean the seal if needed before shutting the door. Be sure the door latch is closed and locked before using your camera.

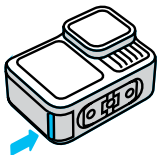

**NOTE:** Your camera's door is removable. Be sure that the door is securely locked and sealed after closing.

## Getting Started

---

### UPDATING YOUR CAMERA

You must update your camera before you can use it.

#### Updating With the GoPro Quik App

1. Download the app to your phone from the Apple® App Store® or Google Play™.
2. Make sure you have internet access, then turn on your GoPro by pressing the Mode button .
3. Follow the app's on-screen instructions to complete the update.

#### Updating Manually

1. Visit [gopro.com/update](https://gopro.com/update).
2. Choose *HERO13 Black* from the list of cameras.
3. Select *Update your camera manually* and follow the instructions.

---

**PRO TIP:** The app will check for the latest camera software every time it connects to your GoPro. This helps ensure that you'll always have the latest features and best performance from your GoPro. If new software is available, the app will tell you how to install it.



**WARNING:** Do not remove your battery or SD card from your GoPro while the update is in progress. Removing your battery or SD card during an update may permanently damage your GoPro.

---

## Getting to Know Your GoPro

---

### POWERING ON

Press the Mode button  to turn on your camera.

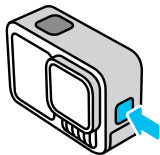

### POWERING OFF

Press and hold the Mode button  for 3 seconds to turn it off.

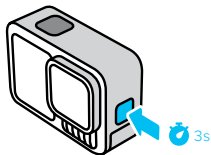

**WARNING:** Use caution when using your GoPro and its mounts and accessories. Always be aware of your surroundings to avoid injuring yourself and others.

Be sure to follow all local laws including all privacy laws, which may restrict recording in certain areas.

---





## Getting to Know Your GoPro

---

### FRONT SCREEN OPTIONS

The front screen features 4 display options.

1. Swipe down on the rear screen to access the Dashboard.
2. Tap  to access the front screen settings.
3. Tap the icon of the setting that you want.

Setting	Description
 Full Screen	Displays the live preview as a full-screen shot. The image is cropped for the display, but will be captured without cropping.
 Actual Screen	Displays the live preview from the lens without cropping.
 Status Only	Displays camera status without the live preview from the lens.
 Screen Off	Turns the screen off. Use this setting in dark environments where light from the screen might interfere with your shot. This setting also maximizes battery life.



## Getting to Know Your GoPro

---

### USING THE REAR TOUCH SCREEN



**Tap**  
Select an item.

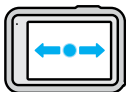

**Swipe Left or Right**  
Switch between Video, Photo,  
and Time Lapse modes.

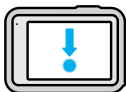

**Swipe Down from the Top of the Screen**  
Access your camera's Dashboard.

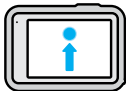

**Swipe Up from the Bottom of the Screen**  
See the last photo or video you captured  
and access the Media Gallery.



**Press and Hold the Capture Screen**  
Turn on and adjust Exposure Control.

**PRO TIP:** You can hide your camera's status information and icons on both the front and rear screen by tapping the rear screen. Tap the screen again or press a button to bring it all back.

## Getting to Know Your GoPro

---

### CAPTURE MODES

Your GoPro has 3 main capture modes.

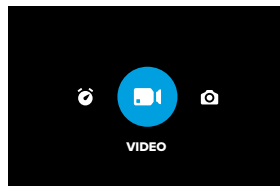

Using the rear touch screen, swipe left or right to the mode you want.

#### **Video (Default)**

Captures your adventure in high-quality video.

#### **Photo**

Your GoPro captures 27MP photos using the ultra versatile 8:7 aspect ratio.

#### **Time Lapse**

Time Lapse turns long events into short, shareable videos by taking a frame of video at set intervals.

**PRO TIP:** With the camera on, you can press the Mode button  to switch modes.

## Getting the Shot

---

### GETTING THE SHOT

1. With your GoPro on, simply press the Shutter button  to start recording.

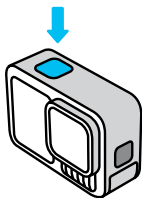

2. Press the Shutter button  again to stop recording (Video, Time Lapse, and Live Streaming only).

### RECORDING WITH QUIKCAPTURE

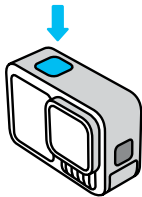

QuikCapture is the fastest and easiest way to power on your GoPro and get the shot. All it takes is the push of the Shutter button.

3. With your camera off, press the Shutter button .



## Getting the Shot

---

4. Press the Shutter button  again to stop recording and turn off your camera.
5. Your camera will begin a 5-second countdown. During the countdown, you have 4 options.
  - a. Press the Shutter button to start recording again immediately.
  - b. Press the Mode button  to exit QuikCapture and go the video capture screen.
  - c. Press and hold the Mode button to immediately shut down your camera.
  - d. Wait for the countdown to elapse and automatically shut down your camera.

*Heads Up:* When using QuikCapture, your camera will start recording with the video settings that you used last.

For more Video options, see [Recording Video \(page 39\)](#).

### Turning Off QuikCapture

QuikCapture is on by default, but you can turn it off.

1. Swipe down on the rear screen to access the Dashboard.
2. Swipe left and tap Preferences > General > QuikCapture.



---

**PRO TIP:** Since it only turns the camera on when it's recording, QuikCapture is a great way to maximize battery life.

## HiLight Tags

---

### ADDING HIGHLIGHT TAGS

Mark favorite moments in your videos and photos by pressing the Mode button  during recording or playback. This adds a HiLight Tag  that makes those moments easier to find when you're watching your footage, creating a video, or looking for a certain shot.

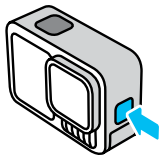

You can also add HiLight Tags by saying, "GoPro, HiLight" when Voice Control is on and by tapping  when watching your footage with the GoPro Quik app.

---

**PRO TIP:** The Quik app looks for HiLight Tags when it creates videos. This helps to ensure that favorite moments are included in your highlight videos.

## Screen Orientation

---

### LOCKING THE SCREEN ORIENTATION

You can easily switch between landscape and portrait shots by rotating your camera. It can even capture photos and videos right-side up when it's mounted upside down.

The orientation is locked in when you press the Shutter button . If your camera tilts during recording, like on a roller coaster, your footage will tilt with it. You'll capture every twist and turn.

You can lock the screen in landscape or portrait orientation. This is especially useful when you're using body and handheld mounts. That's when accidentally shooting in the wrong orientation is most likely to happen.

Swipe down on the rear screen to access the Dashboard.

1. Turn your camera to the orientation you want.
2. Tap  on the Dashboard.

The screen is now locked and will match the orientation of your camera.

## Using Easy Controls

---

Easy Controls make it as easy as possible to point, shoot, and get amazing results with your GoPro. Each mode is preloaded with ultra versatile capture settings that are great for most shots.

### THE FRONT SCREEN

The front LCD screen shows your camera's status, plus a live view from the lens. This makes it easy to capture perfectly framed shots.

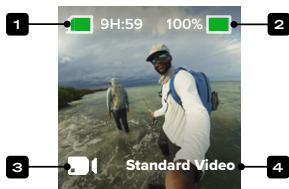

1. Recording Time/Photos Remaining
2. Battery Status
3. Current Mode (Video, Photo, or Time Lapse)
4. Capture Setting

## Using Easy Controls

---

### THE REAR TOUCH SCREEN

The rear touch screen gives you access to your camera's capture settings.

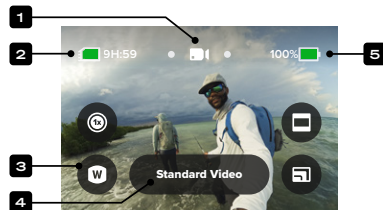

1. Current Mode (Video, Photo, or Time Lapse)
2. Recording Time/Photos Remaining
3. Customizable On-Screen Shortcuts
4. Capture Setting/Center Button
5. Battery Status

*Heads Up:* The capture settings are not available when you turn your GoPro to take portrait shots. Be sure to choose the settings you want before rotating your camera.

---

**PRO TIP:** Press the Mode button  to quickly jump back to this screen from almost anywhere.

## Using Easy Controls

---

### CHANGING MODES

1. Using the rear touch screen, swipe left or right to the mode that you want.

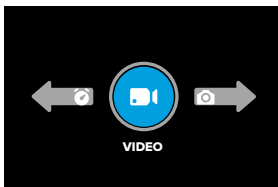

2. Each capture mode has 2 or more capture options. Access sub-modes by tapping the center button.

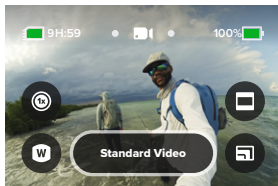



## Using Easy Controls

---

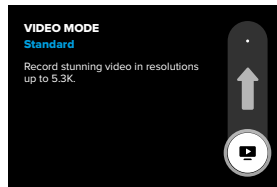
3. Use the slider to choose from the available options.



### VIDEO OPTIONS

There are 2 recording options in Video mode—Standard or HDR video. Tap the center button  to switch between them. Each works by pressing the Shutter button  to start recording, and then pressing it again to stop.

#### Standard Video (Default)

Great for most shots, this setting captures standard-format video in resolutions up to 5.3K.

#### HDR Video

Uses High Dynamic Range (HDR) to bring out details in your footage that might blend into shadows or bright spots. HDR works best when used in bright environment.



---

**PRO TIP:** You can change your video quality by tapping .

## Using Easy Controls

---

### PHOTO MODE OPTIONS

You have 3 capture options in Photo mode. Tap the center button  to switch between them. Each press of the Shutter button  will take a single photo.

#### SuperPhoto (Default)

Takes single photos using the best image processing for your shot. All photos are captured at 27MP using the ultra versatile 8:7 aspect ratio.

#### Burst

Shoots a burst of up to 30 photos in 1 second based on lighting conditions. Perfect for capturing fast-action shots.



#### Night Photo

Night Photo automatically adjusts your camera's shutter speed to let in more light for your shot. It's perfect for dim or dark scenes, but not recommended for handheld or mounted shots when the camera is moving.

## Using Easy Controls

---

### TIME LAPSE MODE OPTIONS

There are 4 Time Lapse capture options. Tap the center button  to switch between them. Each works by pressing the Shutter button  to start recording, and then pressing it again to stop.

#### TimeWarp (Default)

Lets you speed up time by using TimeWarp video stabilization to capture ultra smooth time lapse video while you're on the move. Tap the screen during recording to activate Speed Ramp—a special effect that dramatically slows down your TimeWarp to real speed. Tap the screen again to speed back up.

#### Star Trails

Mount your camera to a stationary object or tripod, point it toward the night sky, and let physics take over. Star Trails uses the Earth's rotation and the stars to create beautiful trails of light across the sky. Use the trail length effect to choose maximum, long, or short trail lengths.

#### Vehicle Lights

Mount your camera to a stationary object or tripod and point your camera at moving vehicles to create stunning light trail footage. Be sure to use the trail length effect to choose maximum, long, or short trail lengths.

#### Light Painting

Light Painting uses a long exposure to let you create brilliant brush stroke effects with moving light. Mount your camera to a stationary object or tripod, grab a flashlight, glow stick, or other light source, and get creative.

## Using Easy Controls

### ADJUSTING CAPTURE SETTINGS

Each mode features onscreen shortcuts that make it easy to adjust your GoPro's capture settings. You can change slo-mo speed, digital lenses, framing, and more.

1. Tap the shortcut of the setting that you want to adjust.

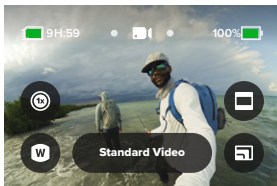

2. Use the slider to adjust the setting.

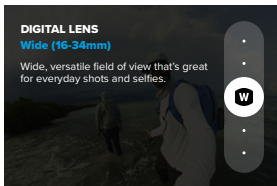

## Using Easy Controls

### CAPTURE SETTING OPTIONS

The available settings will vary by mode. Available settings will also vary based on the speed, lens, and frame that you choose for your shot.



#### Speed (Video)

Set your GoPro to capture video at normal speed (1x), 2x slo-mo, 4x slo-mo, or 8x slo-mo. All videos recorded in 2x slo-mo and above can be played back in slow motion or normal speed.

To learn more, see [Frames per Second \(FPS\) \(page 117\)](#).



#### Lens (Video, Photo, Lapse)

Changing digital lenses on your GoPro is just like switching out the lenses on a traditional camera. They affect the field of view, the cropping, and the fisheye effect in your shot. Your GoPro has Wide, Linear, Linear + Horizon Lock/Leveling, SuperView, and HyperView digital lenses to choose from.

To learn more, see [Digital Lenses \(Video\) \(page 118\)](#).



#### Framing (Video, Lapse)

Set your GoPro to capture widescreen (16:9 frame/aspect ratio) for full-screen playback on a TV or posting on YouTube, vertical (extra-tall 9:16 frame/aspect ratio) for playback on your phone or sharing on social media, or full frame (8:7 frame/aspect ratio) with the flexibility to crop your footage into widescreen or mobile shots using the GoPro Quik app.

To learn more, see [Regional Format \(page 90\)](#).

## Using Easy Controls

---



### Video Quality (Video, Lapse)

Choose Highest quality (5.3K video resolution), Standard quality (4K video resolution), or Basic quality (1080p video resolution).

To learn more, see [Video Quality Options \(page 112\)](#).



### Timer (Photo, Burst Photo)

Set up a timer to capture a photo 3 or 10 seconds after pressing the Shutter button . Use it to set up a selfie, group shot, and more.



### Interval (Photo)

Set up Interval Photo and choose how often your GoPro takes a photo—from a 0.5-second to 120-second interval.

To learn more, see [Interval \(Interval Photo\) \(page 128\)](#).



### Trail Length (Lapse)

Set the length of the light trails when recording with the Star Trails, Light Painting, or Vehicle Light Trails presets. Choose Max for continuous trails with no breaks, long trails, or short trails.

## Using Pro Controls

---

Pro Controls unlock your GoPro's preset settings and the ability to take complete control of all modes, settings, and features.

### THE FRONT SCREEN

The front LCD screen shows your camera's status, plus a live view from the lens. This makes it easy to capture perfectly framed shots.

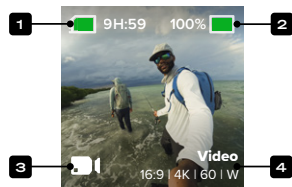

1. Recording Time/Photos Remaining
2. Battery Status
3. Current Mode (Video, Photo, or Time Lapse)
4. Capture Settings



## Using Pro Controls

---

### THE REAR TOUCH SCREEN

The rear touch screen gives you access to your camera's capture settings.

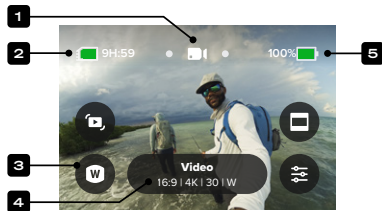

1. Current Mode (Video, Photo, or Time Lapse)
2. Recording Time/Photos Remaining
3. Customizable On-Screen Shortcuts
4. Capture Settings/Center Button
5. Battery Status

*Heads Up:* The capture settings are not available when you turn your GoPro to take portrait shots. Be sure to choose the settings you want before rotating your camera.

---

**PRO TIP:** Press the Mode button  to quickly jump back to this screen from almost anywhere.

## Using Pro Controls

---

### PRO CAPTURE MODES

#### Video (Default)

Includes Video and Burst Slo-Mo presets.

To learn more, see [Recording Video \(page 39\)](#).

#### Photo

Includes Photo, Burst, and Night Photo presets.

To learn more, see [Taking Photos \(page 45\)](#).

#### Time Lapse

Includes TimeWarp, Star Trails, Light Painting, Vehicle Light Trails, Time Lapse, and Night Lapse presets.

To learn more, see [Capturing Time Lapse \(page 50\)](#).

*Heads Up:* You can choose which preset will be loaded and ready to go when you turn on your GoPro.

1. Swipe down on the rear screen to access the Dashboard.
2. Swipe left and tap Preferences > General > Default Preset.

### SWITCHING CONTROLS

Your GoPro uses the Easy Controls by default, but you can switch to the Pro Controls with just a couple of swipes and a tap.

1. Swipe down on the rear screen to access the Dashboard.
2. Swipe left and tap Controls to toggle between the Easy and Pro Controls.

## Pro Control Presets + Shortcuts

---



### CHANGING PRESETS

Each capture mode has presets that make it easy to switch back and forth between the best mode and settings for your shot.

1. From the capture screen, tap the center button .
2. Tap the preset that you want from the list. All of the preset's settings will be locked into your camera and ready to go.

### CUSTOMIZING THE PRESETS

You can change the settings in your presets with just a few taps.

1. From the capture screen, tap .
2. Tap the setting that you want to change.
3. Use the slider to scroll through the settings. The on-screen instructions will help explain your options.  
For details on settings, see [Tech Specs \(starting page 112\)](#).
4. Scroll down to access the advanced Protune settings.  
To learn more, see [Protune \(starting page 137\)](#).
5. Scroll back to the top and tap  to save your changes and return to the presets screen.

*Heads Up:* You can't delete the preloaded presets, but you can customize them any way you want. You can also create your own custom presets.

To learn more, see [Creating Your Own Presets \(page 36\)](#).

---





**PRO TIP:** You can also get to the settings menu by tapping and holding the center button  of the preset that you want to customize.

## Pro Control Presets + Shortcuts

---

### HIDING + REORDERING PRESETS



You can manage presets by hiding those you aren't currently using and rearranging your list.

1. From the capture screen, tap the center button .
2. From the list of presets, tap  in the upper right corner.
3. Tap  next to the preset you want to hide.
4. Tap, hold, and move the presets to reorder them any way you'd like.
5. Tap  to save your changes and return to the presets screen.

### RESTORING PRESETS TO THEIR ORIGINAL SETTINGS

#### Restoring All Presets for a Capture Mode

You can restore all of a capture mode's original preset settings at any time.

1. From the presets screen, tap .
2. Tap  to reset all of the presets back to their original settings.
3. Tap Reset when prompted.

---

**PRO TIP:** You can also restore all presets for every mode simultaneously.

1. Swipe down on the rear screen to access the Dashboard.
2. Swipe left and tap Preferences > Reset > Reset Presets.

#### Restoring an Individual Preset

You can also restore the original settings of individual presets.

1. From the capture screen, tap the center button .
2. Tap the preset that you want to restore from the list.
3. Scroll to the bottom of the settings list and tap Restore.



## Pro Control Presets + Shortcuts

---

### CREATING YOUR OWN PRESETS

The perfect capture settings for a day on the slopes may not be so great when you're recording indoors. Custom presets let you set up and save settings for both shots so you can switch back and forth in no time.



#### Creating a Preset from Scratch

1. Select the capture mode for your new preset—Video, Photo, or Time Lapse.
2. Scroll to the bottom of the list of presets and tap Create New Preset.
3. Tap the settings you'd like to use for your new preset. Tap  when you're finished.
4. Choose an icon and name for your preset. You can choose from the list of names or use the in-camera keyboard to create your own. Heads Up: Chinese, Korean, and Japanese characters are not supported.
5. Tap  to save your preset.

---

**PRO TIP:** You can also use the GoPro Quik app to give your new preset any name you want.

#### Saving Changes to an Existing Preset

1. Go to the capture settings of the preset that you want to modify.
2. Tap the settings to make adjustments to your new preset.
3. Scroll to the bottom of the settings list and tap .
4. Choose an icon and name for your preset.
5. Tap  to save your preset.

---

**PRO TIP:** You may need to fine-tune your presets after trying them out. Tap  to make adjustments.

## Pro Control Presets + Shortcuts

---

### DELETING YOUR PRESET

1. Go to your preset's settings.
2. Scroll to the bottom of the settings list and tap .

### OVERRIDING DASHBOARD SETTINGS

You can set up your presets to have customized Dashboard settings. This means that the voice control, camera beeps, screen saver, screen lock, front screen, orientation lock, and LED settings can be tailored to the preset for use in specialized shots.

For example, you might want to set up a preset for night footage. You can override the Dashboard settings to turn off the front screen and LEDs so that the light doesn't interfere with your shot.

### SETTING UP DASHBOARD OVERRIDE

1. From the capture screen of the preset that you want to adjust, tap .
2. Scroll through the settings until you reach the Dashboard section.
3. Tap the setting that you'd like to adjust.
4. Use the slider to adjust the setting.

*Heads Up:* The override only affects the presets that you adjusted. Any adjustments that you make on the Dashboard when using other presets will not affect presets that use Dashboard override.

To learn more, see [Using the Dashboard \(page 83\)](#).

## Pro Control Presets + Shortcuts

---

### PERSONALIZING ON-SCREEN SHORTCUTS

On-screen shortcuts give you quick one-tap access to your camera's capture settings. Each mode has its own default shortcuts, but you can change them to the settings that you use most. You can even set up different shortcuts for each preset.

#### From the Capture Screen

1. From the capture screen, tap and hold the shortcut you want to switch.
2. Scroll through all of the available shortcuts on the right and choose the one you want.

#### From the Preset Screen

1. Tap the  next to the preset you want to adjust.
2. Scroll down to Shortcuts.
3. Tap where you'd like to put your new shortcut.
4. Scroll through all of the available shortcuts and choose the one you want.

Almost any capture and Protune setting is available as a shortcut. See [Tech Specs \(starting page 112\)](#) and [Protune \(starting page 137\)](#).

## Recording Video

---

Pro Control Video features 2 presets. They let you capture high-quality standard video or capture short video clips in extreme slow motion.

### VIDEO PRESETS

#### Video (Default)

Video mode gives you the flexibility to record in a wide range of resolutions from standard HD 1080p all the way up to pro-quality 5.3K. You also have full control of frame rates, aspect ratio, and more.

---

**PRO TIP:** After you've found settings that you like, save them as presets. This will let you switch back and forth between frequently used settings in just a few taps.

#### Burst Slo-Mo

Burst Slo-Mo lets you capture short video clips at insanely high frame rates for incredibly slow and fluid slo-mo footage down to 13x normal speed.

To learn more, see [Burst Slo-Mo \(page 125\)](#)

## Recording Video

---

### ON-SCREEN SHORTCUTS

The video presets feature 4 default shortcuts, but you can swap them out with any shortcuts you'd like.

To learn more, see [Personalizing On-Screen Shortcuts \(page 38\)](#).

### HyperSmooth

The HyperSmooth shortcut lets you quickly choose your level of video stabilization for your shot—Off, On, or AutoBoost. HyperSmooth options may vary based on the video resolution and frame rate selected.

**PRO TIP:** You can smooth out your footage even more by using Zoom to crop your shots before you start recording. This will give your camera an even bigger buffer to use when stabilizing your video. Using the Linear + Horizon Lock digital lens will also enhance stabilization.

To learn more, see [HyperSmooth Video Stabilization \(page 124\)](#).

### Digital Lens

Tap the Digital Lens shortcut to choose the Wide, Linear, Linear + Horizon Lock/Leveling, SuperView, or HyperView lens. Some lenses only work with select frame rates. If needed, your GoPro will automatically adjust the frame rate when you switch lenses.

**PRO TIP:** Use the Linear + Horizon Lock/Leveling digital lenses to give your videos the cinematic look of professional productions by keeping the horizon straight and level.

To learn more, see [Horizon Lock / Horizon Leveling \(page 123\)](#).

## Recording Video

---

### Framing

Set your GoPro to capture widescreen (16:9 aspect ratio), vertical (9:16 aspect ratio), traditional (4:3), or full frame (8:7 aspect ratio) footage.

To learn more, see [Regional Format \(page 90\)](#).



### Settings

The Settings shortcut takes you directly to the settings menu, where you'll have access to all of the settings and features for the selected preset.

**PRO TIP:** You can also change your camera settings using the GoPro Quik app.

### ADJUSTING SETTINGS

You can access and adjust the video settings by tapping the Settings shortcut .

Tap to make any changes that you'd like. You can tap  to keep the changes to the preset, or tap  or scroll down to "save as" to save the changes as a new preset.

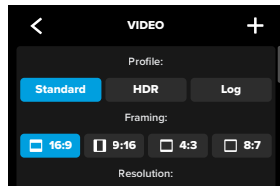

*Heads Up:* Available settings will vary based on the framing, resolution, and frame rate selected, plus whether or not you choose to record in HDR.

## Recording Video

---

To learn more, see:

- [Standard, HDR, HLG HDR + Log Video \(page 113\)](#)
- [Regional Format \(page 90\)](#)
- [Video Resolution \(RES\) \(page 115\)](#)
- [Frames per Second \(FPS\) \(page 117\)](#)
- [Digital Lenses \(Video\) \(page 118\)](#)
- [HyperSmooth Video Stabilization \(page 124\)](#)
- [Burst Slo-Mo \(page 125\)](#)

### CAPTURE SETTINGS

The capture settings are specialized settings and tools to help you get the perfect shot. Access them by tapping the Settings shortcut , and then scrolling down to the Capture section.

#### Scheduled Capture

Set your GoPro to automatically turn itself on and start recording.

To learn more, see [Scheduled Capture \(page 61\)](#).

#### Duration

Choose how long your camera records before automatically stopping.

To learn more, see [Duration Capture \(page 60\)](#).

#### HindSight

Turn HindSight on and set it to save 15 or 30 seconds of video before you press the Shutter button .

To learn more, see [HindSight \(page 58\)](#).

## Recording Video

---

### Timer

Set up a timer to start recording your video 3 or 10 seconds after you press the Shutter button .

### Zoom

Touch Zoom helps you capture a closer view of the action. Use the slider on the right to lock in the zoom level.

### Interval (Looping Video)

Choose how long your GoPro records before looping back to record over the start of the video. The default interval is 5 minutes.

To learn more, see [Looping Video \(page 44\)](#).

### PROTUNE

You can find Protune settings under the Capture settings. Protune gives you manual control of advanced settings, including HLG HDR, Bit Rate, Bit Depth, Color, ISO Limit, and Exposure.

To learn more, see [Protune \(page 137\)](#).

### AUDIO

Scroll past the Protune section to access the advanced audio settings. These settings allow you turn on RAW audio, Audio Tuning, Wind Suppression and Media Mod.

To learn more, see [Tech Specs: Audio \(page 145\)](#).

### DASHBOARD

Scroll past the Audio section to access Dashboard override. From here you can customize the Dashboard settings for your presets.

To learn more, see [Overriding Dashboard Settings \(page 37\)](#).

## Recording Video

---

### SHORTCUTS



Lets you change the default on-screen shortcuts to the settings that you use most for quick and easy access.

To learn more, see [Personalizing On-Screen Shortcuts \(page 38\)](#).

### LOOPING VIDEO

Looping lets you save space on your SD card by recording in a continuous loop until you've captured the moment you want. Use it when you're waiting for something to happen (like fishing) or when nothing may happen (like a dashcam).

Here's how it works:

- If you select 5-minute intervals, only the previous 5 minutes are saved when you press the Shutter button  to stop recording.
- If you record for 5 minutes and don't press the Shutter button , your camera will loop back and record over the start of the video.

You can set your GoPro to record 5- (default), 20-, 60-, or 120-minute loops. It can also be set to Max, which will record until your SD card is full before looping back to record over the start of the video.

### Set Up Looping Video

To capture Looping video, you'll need to set up a new preset and choose Looping when selecting a capture mode.

To learn more, see [Creating Your Own Presets \(page 36\)](#).

## Taking Photos

---

Pro Control Photo mode features 3 presets. All photos are captured at 27MP using the 8:7 aspect ratio. The default digital lens on all 3 presets is set to Wide.

### PHOTO PRESETS

#### Photo (Default)

Use this preset to capture photos with SuperPhoto image processing.

#### Burst

Burst automatically shoots up to 30 photos in 1 second based on lighting conditions.

#### Night Photo

Automatically adjusts your GoPro's shutter speed for dark and low-light shots.

#### On-screen Shortcuts

The photo presets feature 4 default shortcuts, but you can swap them out with any shortcuts you'd like.

To learn more, see [Personalizing On-Screen Shortcuts \(page 38\)](#).

#### Photo Timer

Set up a timer to take a photo 3 or 10 seconds after you press the Shutter button .

*Heads Up:* To help prevent blurry low-light shots, the timer is automatically set to 3 seconds when you switch to Night Photo mode.

#### Digital Lenses

Tap the Digital Lenses shortcut to swap between the Wide and Linear lens.

To learn more, see [Digital Lenses \(Photo\) \(page 129\)](#).

## Taking Photos

---

### Interval Photo

Tap this shortcut to set up Interval Photo and choose how often your GoPro takes a photo—from a 0.5-second to 120-second interval.

To learn more, see [Interval \(Interval Photo\) \(page 128\)](#).

### Settings



The Settings shortcut takes you directly to the settings menu where you'll have access to all of the settings and features for the selected preset.

---

**PRO TIP:** You can also change settings using the GoPro Quik app.

### ADJUSTING SETTINGS

You can access and adjust the photo settings by tapping the settings shortcut .

Tap to make any changes that you'd like. You can tap  to keep the changes to the preset, or tap  or scroll down to "save as" to save the changes as a new preset.

Tap any setting that you want to use for your photo.

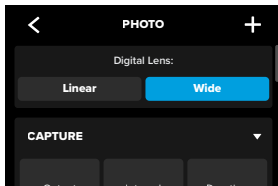

To learn more, see [Digital Lenses \(Photo\) \(page 129\)](#).

## Taking Photos

---

### CAPTURE SETTINGS

The capture settings are specialized settings and tools to help you get the perfect shot. Access them by tapping the settings shortcut , and then scrolling down to the Capture section.

### Output

Set the type of processing for your shot and how the files are saved. Choose SuperPhoto, HDR, Standard, or RAW Format.

To learn more, see:

- [SuperPhoto \(page 126\)](#)
- [High Dynamic Range \(HDR\) \(starting page 126\)](#)
- [RAW Format \(page 130\)](#)

### Interval (Photo)

Set up Interval Photo and choose how often your GoPro takes a photo—from a 0.5-second to 120-second interval.

To learn more, see [Interval \(Interval Photo\) \(page 128\)](#).

### Duration (Photo)

Choose how long your camera automatically captures using its Interval Photo feature before stopping.

To learn more, see [Duration Capture \(page 60\)](#).

### Scheduled Capture

Set your GoPro to automatically turn itself on and start recording.

To learn more, see [Scheduled Capture \(page 61\)](#).



## Taking Photos

---

### Timer

Set up a timer to take a photo 3 or 10 seconds after you press the Shutter button .

*Heads Up:* To help prevent blurry low-light shots, the timer is automatically set to 3 seconds when you switch to Night Photo mode.

### Zoom

Touch Zoom helps you capture a closer view of the action. Use the slider on the right to lock in the zoom level.

### Burst Rate (Burst)

Choose how many photos your camera will take in a 1-, 3-, 6-, or 10-second burst.

To learn more, see [Burst Rate \(page 129\)](#).

### Shutter (Night Photo)

Set how long your camera's shutter stays open for night shots. Choose longer exposures for darker shots.

To learn more, see [Shutter Speed \(page 128\)](#).

## Taking Photos

---

### PROTUNE

You can find Protune settings under the Capture settings. Protune gives you manual control of advanced settings, including Color, ISO Limit, and Exposure.

To learn more, see [Protune \(starting page 137\)](#).

### DASHBOARD

Scroll past the Protune section to access Dashboard override. From here you can customize the Dashboard settings for your presets.

To learn more, see [Overriding Dashboard Settings \(page 37\)](#).

### SHORTCUTS

Lets you change the default on-screen shortcuts to the settings that you use most for quick and easy access.

To learn more, see [Personalizing On-Screen Shortcuts \(page 38\)](#).

## Capturing Time Lapse

---

Your GoPro has 6 Time Lapse presets. Each lets you swap out aspect ratio, resolution, and lens for your shot, plus make other adjustments.

### TIME LAPSE PRESETS

#### TimeWarp (Default)

Lets you capture ultra smooth time lapse footage while you're on the move. The Speed Ramp feature lets you tap the screen during recording to dramatically slow your footage down to real speed. Tap the screen again to speed back up.

#### Star Trails

Mount your GoPro to a stationary object and point it at the night sky to capture trails of light across the sky.

#### Light Painting

Mount your GoPro to a stationary object, then grab a flashlight, glow stick, or other light source and get creative.

#### Vehicle Light Trails

Mount your GoPro to a stationary object and point it toward moving vehicles to create stunning light trails footage.

#### Time Lapse

Use this preset to capture time lapse video or photos when your camera is mounted and still.

#### Night Lapse

Night Lapse was made to capture time lapse video or photos in dark and low-light environments.

## Capturing Time Lapse

---

### ON-SCREEN SHORTCUTS

The Time Lapse presets vary depending on the capture mode you're using, but you can swap them out with any shortcuts you'd like.

To learn more, see [Personalizing On-Screen Shortcuts \(page 38\)](#).

#### Digital Lens

Tap the Digital Lenses shortcut to swap between lenses. Available lenses will vary based on the capture mode you're using.

To learn more, see [Digital Lenses \(Photo\) \(page 129\)](#).

#### Framing

Set your GoPro to capture widescreen (16:9 aspect ratio), vertical (9:16 aspect ratio), or full frame (8:7 aspect ratio) footage.

To learn more, see [Regional Format \(page 90\)](#).

#### Photo Timer (Star Trails, Light Painting, Vehicle Light Trails)

Set up a timer to take a photo 3 or 10 seconds after you press the Shutter button .

#### Trail Length (Star Trails, Light Painting, Vehicle Light Trails)

Set the length of the light trails when recording with the night effects presets.

#### Settings

The Settings shortcut takes you directly to setting menu where you'll have access to all of the settings and features for the selected preset.

---



**PRO TIP:** You can also change your camera settings using the GoPro Quik app.

## Capturing Time Lapse

---

### ADJUSTING SETTINGS

You can access and adjust the time lapse settings by tapping the Settings shortcut .

Tap to make any changes that you'd like. You can tap  to keep the changes to the preset, or tap  or scroll down to "save as" to save the changes as a new preset.

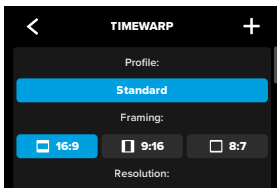

*Heads Up:* Available settings will vary based on the time lapse mode selected.

To learn more, see:

- [Video Resolution \(RES\) \(page 115\)](#)
- [Digital Lenses \(Photo\) \(page 129\)](#)
- [Regional Format \(page 90\)](#)

## Capturing Time Lapse

---

### CAPTURE SETTINGS

The capture settings are specialized settings and tools to help you get the perfect shot. Access them by tapping the settings shortcut , and then scrolling down to the Capture section.

#### Speed (TimeWarp)

Set the speed for your TimeWarp or leave it on Auto (default) to let your GoPro automatically adjust the speed based on motion, scene detection, and lighting.

To learn more, see [TimeWarp Video Speed \(page 131\)](#).

#### Scheduled Capture

Set your GoPro to automatically turn itself on and start recording.

To learn more, see [Scheduled Capture \(page 61\)](#).

#### Duration

Choose how long your camera records before automatically stopping.

To learn more, see [Duration Capture \(page 60\)](#).

#### Timer

Set up a timer to start recording your video 3 or 10 seconds after you press the Shutter button .

#### Zoom

Touch Zoom helps you capture a closer view of the action. Use the slider on the right to lock in the zoom level.

## Capturing Time Lapse

---

### Trail Length (Star Trails, Light Painting, Vehicle Light Trails)

Set the length of the light trails when using the night effects presets. Choose Max for continuous trails with no breaks, long trails, or short trails.

### Interval (Time Lapse)

Choose how often your camera captures a frame of video or takes a photo.

To learn more, see [Time Lapse Interval \(page 134\)](#).

### Interval (Night Lapse)

Set how often your camera takes a shot in low- and ultra low-light scenes. Choose shorter intervals for scenes with a lot of movement and more light. Use longer intervals in scenes with little or no movement or light.

To learn more, see [Night Lapse Interval \(page 136\)](#).

### Output (Time Lapse Photo, Night Lapse Photo)

Save your photos as standard .jpg or RAW files.

To learn more, see [RAW Format \(page 130\)](#).

### Shutter (Night Lapse)

Set how long your camera's shutter stays open for night shots.

To learn more, see [Shutter Speed \(page 128\)](#).

## Capturing Time Lapse

---

### PROTUNE

You can find Protune settings under the Capture settings. Protune gives you manual control of advanced settings, including Bit Depth, White Balance, ISO, and more.

*Heads Up:* Available settings will vary based on the time lapse mode selected.

To learn more, see [Protune \(starting page 137\)](#).

### DASHBOARD

Scroll past the Protune section to access Dashboard override. From here you can customize the Dashboard settings for your presets.

To learn more, see [Overriding Dashboard Settings \(page 37\)](#).

### SHORTCUTS



Lets you change the default on-screen shortcuts to the settings that you use most for quick and easy access.

To learn more, see [Personalizing On-Screen Shortcuts \(page 38\)](#).

## Live Streaming + Webcam Mode

---

### SETTING UP A LIVE STREAM

1. Connect to the GoPro Quik app. For details, see [Connecting to the GoPro Quik App \(starting page 75\)](#).
2. In the app, tap  to control your camera.
3. Tap  and then  and follow the instructions to set up your live stream.

For complete step-by-step instructions, visit [gopro.com/live-stream-setup](https://gopro.com/live-stream-setup).

### USING YOUR GOPRO AS A WEBCAM

Both your GoPro and computer must be set up for webcam mode before you go live. Your camera is in webcam mode by default. Connect your camera to your computer using a USB-C cable, and then follow the step-by-step setup instructions at [gopro.com/webcam](https://gopro.com/webcam).

## Power Tools

---

Your GoPro comes with Power Tools—a full suite of smart capture settings that extend the capture options beyond simply pressing the Shutter button.



### INTERVAL PHOTO

Interval Photo makes it easy to capture amazing hands-free shots while you stay immersed in your adventure. Try it when your hands are busy with handlebars, ski poles, tow ropes, and more. You can also attach your camera to a GoPro backpack strap to get a complete series of photos when you're hiking or exploring new locales.

#### How It Works

Interval Photo snaps photos at fixed intervals while you stay focused on your favorite activities. You can decide how often your GoPro will take a shot—try shorter intervals for quick activities and longer intervals for extended journeys. Later, you can go through the entire series of photos and keep them all or save only the best shots.

#### Setting Up + Using Interval Photo

1. With your GoPro in Photo mode, tap the  Interval Photo shortcut.
2. Set how often you want your GoPro to take a photo.
3. Press the Shutter button  to start capturing photos. Your GoPro will continue to take photos until you press the Shutter button again to stop.

## Power Tools

---

### HINDSIGHT

HindSight is a powerful feature that can capture up to 30 seconds of video before you press the Shutter button. This lets you record key moments even after they happen.

### How It Works

Imagine your kid making the game-winning play during their big game. This is a moment you don't want to miss. With HindSight on, you can frame your shot, but you don't have to start recording. You can press the Shutter button  after they make the big play. HindSight will save the video it captured before you pressed the Shutter button (up to 30 seconds) and will continue recording until you stop the video.



### Setting Up HindSight

1. After choosing a video preset, tap the settings shortcut  to go to the settings menu.
2. Scroll down to the Capture settings and tap HindSight.
3. Set HindSight for either 15 or 30 seconds.

## Power Tools

---

### Using HindSight

Press the Shutter button  at any time to start recording. The indicator at the top center of the screen will turn blue when the HindSight buffer is full. That means that your camera is storing the previous 15 or 30 seconds of video. It will only save the video if you press the Shutter button  to start recording.

*Heads Up:* Make sure that you've locked in the capture settings you want before starting HindSight. You won't be able to change settings once HindSight is on.

### Stopping + Pausing HindSight

You can also tap Stop HindSight at any time to cancel HindSight and save battery power. Your camera will also pause HindSight if you have not started recording 15 minutes after you turned HindSight on. This is another way to conserve battery power.

*Heads Up:* HindSight works by capturing video the entire time that it's on (even when you're not actively recording). Depending on how you use it, HindSight may use your camera's battery capacity faster than recording in normal video mode.



## Power Tools

---

### DURATION CAPTURE

Use duration capture to set how long your GoPro records before it stops. It's available in Video, TimeWarp, Time Lapse, and Night Lapse modes in increments from 15 seconds to 3 hours.

#### Setting Up + Using Duration Capture

1. Tap the settings shortcut  to go to the settings menu.
2. Tap Duration.
3. Use the slider to choose the duration for your shot.
4. Press the Shutter button  to start recording. Your GoPro will automatically stop after recording for the set duration.

*Heads Up:* Duration capture sets how long your GoPro will record. The length of your final video will vary based on the mode you're using. TimeWarp and time lapse videos will be shorter than the set duration.

---

**PRO TIP:** Choose No Limit to capture footage without a time limit. Press the Shutter button  to stop recording.

## Power Tools

---

### SCHEDULED CAPTURE

Scheduled capture lets you set your GoPro to automatically turn itself on and capture a shot up to 24 hours in advance. It's available for all presets.

#### Setting Up + Using Scheduled Capture

1. Tap the settings shortcut  to go to the settings menu.
2. Tap Scheduled Capture.
3. Set when you want your GoPro to capture the shot.
4. After setting the time, you can turn your GoPro off or continue using your camera's other presets.

*Heads Up:* Your GoPro will stay on after taking the shot. It will turn itself off after idling for the length of time set in Preferences.

1. Swipe down on the rear screen to access the Dashboard.
2. Swipe left and tap Preferences > General > Auto Power Off.

---

**PRO TIP:** Use duration capture to choose the shot length when using scheduled capture. Your camera will automatically stop recording after it gets the shot. You'll have to press the Shutter button  to stop recording if you're not using duration capture.

## Exposure Control

---

Your GoPro scans the entire scene to choose the exposure level for your shot. Exposure Control lets you decide if only a section of the shot should be used to set the exposure.

Check out the shot preview on your touch screen. Try Exposure Control if there are sections that are too dark or too light.

### SETTING EXPOSURE CONTROL

If you're snowboarding on a sunny day, you might try locking the exposure on your subject's jacket. This will help prevent your shots from being underexposed (too dark) compared to the bright snow.

1. Tap and hold anywhere on the rear touch screen until a set of brackets appears. The exposure will be based on the area in the brackets.

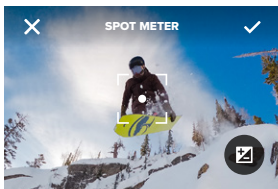



**PRO TIP:** Tapping and holding the center of the screen will bring up the Spot Meter. This will base the exposure on the center of the screen.

## Exposure Control

---

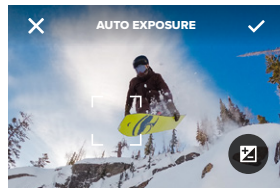
2. You can change the exposure by dragging the brackets to any other area of the screen.



3. Brightness can be fine tuned by tapping . This lets you adjust the Exposure Value Compensation (EV Comp).





Slide up to brighten the image. Slide down to darken it. You can adjust up to 2 stops in either direction.



## Exposure Control

---

4. Check the screen to see if the exposure looks good. Tap inside the brackets to lock in the exposure. A  will appear inside the brackets to confirm that the exposure is locked. You can also tap  to cancel any changes.

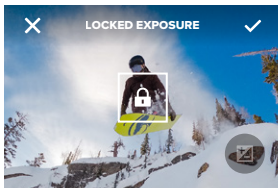

## Exposure Control

---

### TURNING EXPOSURE CONTROL OFF

Tapping the brackets on the capture screen will turn Exposure Control off and reset your camera to full-screen auto exposure.

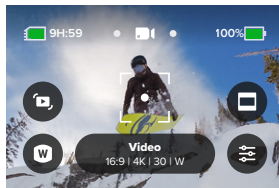

*Heads Up:* If the EV Comp was adjusted during Exposure Control, it will return to its default setting when Exposure Control is turned off. For details, see [Exposure Value Compensation \(EV Comp\)](#) (page 140).

## Using Voice Control

---

Voice Control gives you easy, hands-free control of your GoPro. It's great when you're busy with handlebars, ski poles, and more. Just tell your GoPro what you want it to do.

### TURNING VOICE CONTROL ON + OFF

1. Swipe down on the rear screen to access the Dashboard.
2. Tap  to turn Voice Control on or off.

### LIST OF VOICE COMMANDS

There are 2 types of voice commands: Action commands and Mode commands.

#### Using Action Commands

These commands let you get the shot and switch modes on the fly. You can simply say "GoPro, capture" to record in the mode your camera is set to or switch modes. For example, if you just recorded a video, you can say "GoPro, take a photo" to snap a photo without manually switching modes.

Action Command	Description
GoPro, capture	Starts capturing with the mode your camera is set to.
GoPro, stop capture	Stops capture in Video and Time Lapse modes. Photo and Burst modes stop on their own.
GoPro, stop recording	Stops recording video.
GoPro, take a photo	Takes a single photo.

## Using Voice Control

---

Action Command	Description
GoPro, shoot burst	Takes burst photos.
GoPro, start time lapse	Starts capturing with the last time lapse mode you used.
GoPro, stop time lapse	Stops capturing time lapse.
GoPro, turn off	Turns your camera off.

#### Using Mode Commands

Use these commands to switch capture modes on the go. Then say "GoPro, capture" or press the Shutter button  to get the shot.

Mode Command	Description
GoPro, Video mode	Switches your camera to Video mode (does <b>not</b> start recording).
GoPro, Photo mode	Switches your camera to Photo mode (does <b>not</b> take a photo).
GoPro, Time Lapse mode	Switches your camera to Time Lapse photo mode (does <b>not</b> start taking time lapse photos).

**PRO TIP:** If you're recording video or time lapse, you must stop recording by pressing the Shutter button  or by saying "GoPro, stop capture" before trying a new command.

## Using Voice Control

---

### SEE A COMPLETE LIST OF COMMANDS ON YOUR CAMERA

1. Swipe down on the rear screen to access the Dashboard.
2. Swipe left and tap Preferences > Voice Control > Commands.

### CHANGING YOUR VOICE CONTROL LANGUAGE

1. Swipe down on the rear screen to access the Dashboard.
2. Swipe left and tap Preferences > Voice Control > Language.

*Heads Up:* Voice Control may be affected by wind, noise, and your distance from the camera. Keep your camera clean and wipe away any debris for the best performance.

## Pairing Your GoPro to Other Devices

---

### BLUETOOTH® CONNECTIVITY

Your GoPro can be paired with a wide a variety of Bluetooth® devices to help you get the shot you want or enhance your recording. This can include the GoPro Quik app, GoPro remote controls, wireless external microphones, and wireless earbuds that let your GoPro hear your voice commands when it's mounted out of earshot.

*Heads Up:* An audio meter will appear onscreen any time you're using an external mic.

### PAIRING BLUETOOTH® DEVICES

Make sure that your device is in pairing mode, and then follow these steps on your GoPro:

1. Swipe down on the rear screen to access the Dashboard, and then swipe left to add devices.
2. Tap **+** Pair Device. Your GoPro will automatically start searching for compatible devices.

*Heads Up:* Any currently connected devices will also be shown on this tile. Tap the tile to see a list of paired devices or add a new one.

3. Your GoPro will find all available devices. Tap the one you want to pair.

After pairing the first time, your GoPro and the device will wirelessly connect automatically when both are on with Bluetooth® on.

*Heads Up:* Your GoPro's wireless Connections must be on to pair devices. Follow these steps to turn them on if needed:

1. Swipe down on the rear screen to access the Dashboard.
2. Swipe left and tap Preferences > Wireless Connections > Connections.

## Time Code Sync

---

Timecode sync is available through the GoPro Quik app. This lets you sync the date and time on multiple HERO13 Black cameras for easier and more precise editing.

1. Add your HERO13 Black to the GoPro Quik app.
2. Tap  on the app's HERO13 Black control screen.
3. Tap Sync Timecode. This will bring up a QR code.
4. Scan the QR with any HERO13 Black using any mode or preset.

Your GoPro will let you know if the sync was successful.

*Heads Up:* After adding HERO13 Black to the app, you can access timecode sync through the app's HERO13 Black control screen at any time. You don't have to connect your camera.





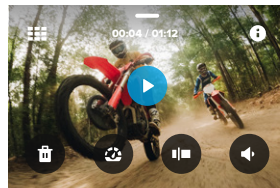

## Playing Back Your Media

---

Swipe up to see the last video, photo, or burst you took. Swipe left and right to flip through the other files on your SD card.







The Media Gallery includes the following playback options:

-  Pause playback
-  Resume playback
-  See all of the media on your SD card
-  See all of the modes and setting used to capture the shot
-  Delete the file from your SD card
-  Play back in slow motion or normal speed

## Playing Back Your Media

---

-  Use a slider to scan through your videos, bursts, and time lapse photos
-  Add/remove HiLight Tag
-  Adjust the playback volume
-  Go to the previous or next photo in a burst or group of continuous photos

*Heads Up:* The playback options will vary based on the type of media you're viewing.

---

**PRO TIP:** Some playback options are not available when you're holding your camera in portrait orientation. Make adjustments to those settings in landscape orientation before rotating your camera.



## Playing Back Your Media

---



### USING GALLERY VIEW

Gallery view gives you quick access to all of the videos and photos stored on your SD card.



1. From the playback screen, tap .
2. Swipe up to scroll through your media.
3. Tap a video or photo to see it in full-screen view.
4. Tap  to select files.
5. Tap  to go back to the playback screen.

*Heads Up:* Gallery view is not available when you're holding your camera in portrait orientation. Also, the more content you have on your SD card, the longer it will take to load.

## Playing Back Your Media

---

### DELETING MULTIPLE FILES

1. Tap .
2. Tap all of the files that you want to delete. Tap a file again if you want to de-select it.
3. Tap  to delete the selected files.

### VIEWING VIDEOS + PHOTOS ON A MOBILE DEVICE

1. Connect your camera to the GoPro Quik app. For details, see [Connecting to the GoPro Quik App \(starting page 75\)](#).
2. Use the controls on the app to play back, edit, and share your videos and photos.

### VIEWING VIDEOS + PHOTOS ON A COMPUTER

To see your media on a computer, you must first save the files to the computer. To learn more, see [Saving Your Media \(starting page 77\)](#).

---

**PRO TIP:** Use the GoPro Quik app to grab still photos from videos, create short shareable videos from full-length footage, save media to your phone, and more.

## Connecting to the GoPro Quik App

---

### GOPRO QUIK APP

Use the GoPro Quik app to control your GoPro—plus view, edit, and share your footage right from your phone or tablet.

1. Download the GoPro Quik app from the Apple® App Store® or Google Play™.
2. Swipe down on your GoPro's screen to access the Dashboard, and then swipe left and tap Pair Device.
3. Make sure that your phone's Wi-Fi and Bluetooth® are on. Start the GoPro Quik app and follow the on-screen instructions to pair your camera.

After the initial connection, your GoPro and the app should sync when both are on with wireless connections on.

### SETTING THE CONNECTION SPEED

Your GoPro is set to use the 5GHz Wi-Fi band (the fastest available) when connecting to other mobile devices.

Change the Wi-Fi band to 2.4GHz if your device or region does not support 5GHz.

1. Swipe down on the rear screen to access the Dashboard.
2. Swipe left and tap Preferences > Wireless Connections > Wi-Fi Band.

## Automatic Highlight Videos

---

**NOTE:** Cloud-based features including automatic highlight videos and Auto Upload are not available in China.

### GET AMAZING HIGHLIGHT VIDEOS SENT TO YOUR PHONE

Have highlight videos of your adventures sent to your phone automatically. All you have to do is sign up for a GoPro Premium or Premium+ subscription and connect your camera to your Wi-Fi network.

1. Subscribe to GoPro at [gopro.com/subscription](https://gopro.com/subscription).
2. Set up your GoPro to automatically upload your footage to the cloud. For details, see [Auto Uploading to the Cloud \(page 148\)](#).
3. Follow the app's onscreen instructions to complete the setup.

*Heads Up:* Be sure to allow notifications so that you'll know when a new highlight video is ready.

Once set up, simply plug in your GoPro to charge while it's connected to your home Wi-Fi network. While it's charging, your footage will be automatically uploaded to the cloud and used to create highlight videos complete with beat-synced music and effects. You'll get a notification on your phone letting you know when your video is ready to watch and share.

### FINDING THE BEST SHOTS

Be sure to mark your best shots with HiLight Tags. The GoPro Quik app looks for tags when it creates videos. This helps ensure that favorite moments are included in your stories.

Your GoPro also knows when you face the camera, smile, and more. It automatically tags these shots with data so the app can handpick them for your videos.

## Saving Your Media

---

### AUTO UPLOADING TO THE CLOUD

With a GoPro Premium or Premium+ subscription, you can automatically upload your media to the cloud where you can view, edit, and share it from any device.

1. Subscribe to GoPro at [gopro.com/subscribe](https://gopro.com/subscribe) or through the GoPro Quik app.
2. Connect your camera to the GoPro Quik app. For details, see [Connecting to the GoPro Quik App \(starting page 75\)](#).
3. Tap  on the camera chooser screen.
4. Connect your camera to a power outlet. The upload will start automatically.

After first-time setup, your camera won't need to connect to the app to start Auto Upload.

### Switching to Manual Cloud Upload

You can also manually upload your media to the cloud at any time. (Your GoPro must be connected to a power outlet, and Auto Upload must be off.)

1. Connect your camera to a power outlet.
2. Swipe down to access the Dashboard.
3. Swipe right and tap Cloud Upload.

## Saving Your Media

---

### ACCESSING YOUR CLOUD MEDIA

1. Open the GoPro Quik app on your device.
2. Tap  and select Cloud to view, edit, and share your content.

**PRO TIP:** Use your cloud media to create video edits with the GoPro Quik app without downloading it to your phone.

### TURNING OFF AUTO UPLOAD

You can keep your camera from trying to upload every time it's connected to a power outlet and fully charged.

1. Swipe down on the rear screen to access the Dashboard.
2. Swipe left and tap Preferences > Cloud Upload > Auto Upload.
3. Tap Off.

### CONNECTING TO A DIFFERENT WIRELESS NETWORK



1. Connect your camera to the GoPro Quik app. For details, see [Connecting to the GoPro Quik App \(starting page 75\)](#).
2. After connecting, tap Manage Auto Upload on the app.
3. Tap Wi-Fi Networks on the app.
4. Choose a Wi-Fi network.
5. Enter the Wi-Fi password.
6. Tap Connect.

## Saving Your Media

---

### SAVING TO YOUR PHONE WIRELESSLY

Wirelessly save your photos and videos to the GoPro Quik app for easy access and sharing on your phone.

1. Connect your camera to the GoPro Quik app. For details, see [Connecting to the GoPro Quik App \(starting page 75\)](#).
2. Tap Download to download all of your new footage to the app.
3. Tap View Media  for a gallery view of all of your media. Tap to select individual files or use  to select multiple files and then tap download to save the selected files to the app.

### SAVING TO YOUR PHONE WITH A WIRED CONNECTION

Use a wired connection to transfer photos and videos from your GoPro to your phone faster and more reliably.

1. Use the appropriate cable/adaptor (not included) to connect your GoPro to your phone.
2. Start the GoPro Quik app on your phone and follow the on-screen instructions.

Phone	Required Cable or Adapter
Android	Standard USB-C to USB-C
iOS® device with USB-C port	Standard USB-C to USB-C
iOS® device with Lightning port	Standard USB-A to USB-C and Apple® Lightning to USB Camera Adapter



## Saving Your Media

---

### SAVING TO A COMPUTER

Copy your media from your SD card to a computer for playback and editing.

1. Remove the SD card from your camera.
2. Insert the card into an SD card reader or adapter.
3. Plug the card reader into your computer's USB port, or insert the adapter into the SD card slot.
4. Copy your files into the GoPro Quik app.

---

**PRO TIP:** Low-resolution video (LRV) and thumbnail (THM) files are hidden from view. These files are accessible on Mac® or Windows®.

**Mac:** Open the folder with the video files and press Command + Shift + . (dot).

**Windows:** From the Windows File Explorer, select View > Show > Hidden Items.

## Deleting Your Media

---

### AUTO CLEAR (DELETING MEDIA AUTOMATICALLY)

Your camera can be set to automatically delete all of the media from your camera's SD card once it has been safely uploaded to the cloud. This ensures that there's room on your SD card for new photos and videos the next time you use your GoPro.

Auto Upload will also recognize any new photos and videos on your SD card the next time your camera is plugged in for cloud backup. Only the new files will be saved to the cloud and deleted from your SD card.

1. Swipe down on the rear screen to access the Dashboard.
2. Swipe left and tap Preferences > Setup Cloud Upload > Auto Clear.

### MANAGE SD CARD (DELETING MEDIA MANUALLY)

This gives you several options for manually deleting media on your SD card. Options are based on whether or not your media has been uploaded and saved to the cloud.

- Delete only the media that has been uploaded and saved to the GoPro cloud, while keeping anything that has not been uploaded.
- Delete all media from your SD card, whether it has been uploaded and save to the GoPro cloud or not.
- Delete the other data on your SD card.

Your GoPro will always verify whether or not you want to delete the media before it permanently deletes it from your SD card.

1. Swipe down on the rear screen to access the Dashboard.
2. Swipe left and tap Manage SD Card.

## Deleting Your Media



---

### DELETING INDIVIDUAL FILES

You can delete individual files or selected files in the Media Gallery. For details, see [Playing Back Your Media \(starting page 71\)](#).

### GALLERY VIEW WITH THE GOPRO QUIK APP

Use the GoPro Quik app to see a gallery view of the media on your SD card. From there you can easily tap to select the files to delete.

1. Open the GoPro Quik app and tap  to access your GoPro.
2. Tap View Media to see the photos and videos on your SD card.
3. Tap  and then the thumbnails of the photos and videos you'd like to delete.
4. Tap  to delete the selected files.

---

**PRO TIP:** You can also tap  along the bottom navigation bar of the app to access a gallery view of all the media stored in the app, in the cloud, and on your phone.

### REFORMATTING YOUR SD CARD

Reformatting is the fastest way to delete all of the media on your SD card. This will erase all of your media, so be sure to save it first.

1. Swipe down on the screen to access the Dashboard.
2. Swipe left and tap Preferences > Reset > Format SD Card.
3. Tap Format to delete all files and reformat your card.

---

**PRO TIP:** Reformatting your SD card regularly will also help keep it in good condition.

## Setting Your Preferences

---





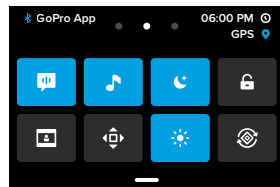



### USING THE DASHBOARD

With your camera in landscape orientation, swipe down on the rear screen to access the Dashboard.



### Dashboard Features

The Dashboard lets you quickly tap the following settings on and off:

	Voice Control		Front Screen Settings
	Camera Beeps		Orientation Lock
	Screen Saver		Lens Mod Mode
	Screen Lock		LEDs

## Setting Your Preferences

---

### SD CARD STATUS

With your camera in landscape orientation, swipe down on the rear screen to access the Dashboard, and then swipe right to access your SD card status. From this screen you can manage SD card storage and set up cloud upload with a GoPro subscription.

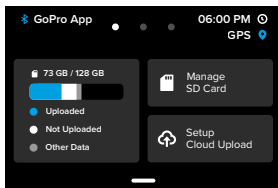

### SD Card Storage

The tile on the left shows your SD card capacity.

- The blue bar shows the amount of media on your SD card that has been uploaded and saved to the GoPro cloud.
- The white bar shows the amount of media on your SD card that hasn't been uploaded to the GoPro cloud.
- The gray bar represents any other data on your SD card that your GoPro doesn't use and recognize (this data is not backed up to the GoPro cloud).

## Setting Your Preferences

---

### Manage SD Card

Tap  for options to manually delete files on your SD card. For details, see [Manage SD Card \(page 81\)](#).

### Setup Cloud Upload

Tap  to back up your media to the cloud with a GoPro subscription. There are 3 options available based on your camera's upload and connection status:

- Setup Auto Upload: Cloud upload has not been set up. Tap to set up cloud upload for your media.
- Start Upload: There is media on your SD card that has not been uploaded. Tap to start uploading your media manually.
- Cloud Upload (in gray): There is no media to upload or your camera is not connected to a network.

For information on uploading to the cloud, see [Auto Uploading to the Cloud \(page 148\)](#).

## Setting Your Preferences

---

### DEVICES, CONTROLS + PREFERENCES

With your camera in landscape orientation, swipe down on the rear screen to access the Dashboard, and then swipe left to add devices, change controls, and access preferences.

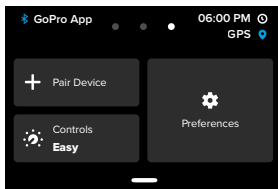

#### Pair Device

Tap to pair new devices with your GoPro. For details, see [Bluetooth® Connectivity \(page 69\)](#).

#### Controls

Tap to toggle between Easy and Pro Controls.

#### Preferences

Tap to set up your GoPro exactly the way you want it.

## Setting Your Preferences

---

### SETUP CLOUD UPLOAD

#### Auto Upload

Set up and turn on auto upload to the cloud with your GoPro subscription.

#### Start Upload

Lets you start uploading media to the cloud immediately.

#### Auto Clear

Automatically clears all media from your SD card after it's been uploaded to the cloud.

### CONNECTIONS

#### Connections

Turn your camera's wireless connections on and off.

#### Wireless Info

See your camera's name and password.

#### Wi-Fi Band

Choose 5GHz or 2.4GHz as your connection speed. Set 5GHz only if your phone and region support it.

To learn more, see [Setting the Connection Speed \(page 75\)](#).

#### Reset Connections

Clear all connections to your devices and reset your camera's password. This means you'll have to reconnect each device.

## Setting Your Preferences

---

### GENERAL

#### QuikCapture

QuikCapture is on by default. You can turn it off here.

#### Default Preset

Set the preset your GoPro captures in when you turn it on using the Mode button . This setting does not affect QuikCapture.

#### Auto Power Off

Choose 5 Min (default), 15 Min, 30 Min, or Never.

#### LEDs

Set which status lights blink. Choose All On (default), All Off, or Front Off Only.

#### GPS

Turn GPS on to tag your footage with location, speed, altitude, and more that you can include as optional data overlays in your footage.

### VOICE CONTROL

#### Language

Choose your Voice Control language.

#### Commands

See a complete list of voice commands.

To learn more, see [Using Voice Control \(page 66\)](#).

## Setting Your Preferences

---

### AUDIO

#### Camera Volume

Set the volume for your camera's sounds and alerts.

#### External Mics

Choose the type of wired microphone you're using with your GoPro. If you're not sure which option to select, check the information that came with your microphone.

Option	Description
Standard Mic (default)	Supports non-powered mics.
Standard Mic+	Supports non-powered mics and provides 20dB boost.
Powered Mic	Supports self-powered mics.
Powered Mic+	Supports self-powered mics and provides 20dB boost.
Line In	Supports line-level output from other audio equipment (mixing board, guitar preamplifier, karaoke machine, etc.).

*Heads Up:* An audio meter will appear onscreen any time you're using an external mic.

## Setting Your Preferences

---

### DISPLAYS

#### Screen Saver

Set the screen saver to 1, 2 (default), 3, or 5 minutes. Choose Never to leave your screen on.

*Heads Up:* The camera buttons and Voice Control still work even when the screen is off.

#### Brightness

Use the slider to adjust your screen's brightness.

#### Grid

Use a grid on the rear touch screen to frame your shot.

### REGIONAL

#### Language

Choose the language that appears on your camera.

#### Regional Format

Choose the regional frame rate for recording and playback on a TV. The right format for your region will help prevent flicker on a TV/HDTV. 60Hz (NTSC) regions include North America, Japan, Taiwan, the Philippines, and parts of South America. 50Hz (PAL) regions include most of Europe and Africa, China, Australia, and India. Be sure check your region to see which setting to use.

## Setting Your Preferences

---

### DATE / TIME

#### Date Format

This is set automatically based on the language that you chose at setup. You can also change it manually here.

#### Date

Use to manually adjust the date. The date is automatically updated when you connect your camera to the GoPro Quik app.

#### Time

Use to manually adjust the time. The time is automatically updated when you connect your camera to the GoPro Quik app.

#### Time Zone

Set your camera's time zone.

#### Daylight Savings Time

Turn daylight savings time on if you are in a region that is currently observing daylight savings time. Your camera's clock will set itself one hour ahead. Turn daylight savings time off when daylight savings time is over to return to standard time.

### ABOUT

#### GoPro Updates

Update your camera's software to ensure you have the latest features and performance upgrades.

#### Camera Info

Find your camera's name and serial number, and see which software version your camera is using.

## Setting Your Preferences

---

### Battery Info

Check your battery's health here. Be sure to use a GoPro Enduro battery for HERO13 Black. Using an older GoPro battery or non-GoPro battery could greatly limit your camera's performance.

### REGULATORY

See your GoPro's certifications.

### RESET

#### Format SD Card

Reformat your SD card. This will erase all of your media, so be sure to save it first.

#### Reset Presets

Reset the preloaded presets to their original settings and delete all custom presets.

#### Reset Camera Tips

See all of the camera tips from the beginning.

#### Factory Reset

Restore all of your camera's settings and clear all connections.

## Important Messages

---

Problems are rare, but your GoPro will let you know if anything comes up. Here are some of the messages you might see.



### CAMERA IS TOO HOT

The Temperature icon appears on the touch screen if your camera becomes too hot and needs to cool down. Your camera was designed to recognize when it's at risk of hitting its thermal limit and will shut down when needed. Simply let it sit and cool before using it again.

*Heads Up:* The operating ambient temperature range of your HERO13 Black is 14° F ~ 104° F (-10° C ~ 40° C) with a charging temperature of 32° F ~ 95° F (0° C ~ 35° C). High temperatures will cause your camera to use more power and drain the battery faster.

---

**PRO TIP:** Shooting video at a high resolution and frame rate will also cause your camera to heat up faster, especially in hot environments. Try switching to a lower resolution and frame rate to lower the risk of your GoPro getting too hot.

### SD Card Error

Your GoPro can detect a variety of problems with your SD card. Problems can be due to, but not limited to, electrostatic discharge. Restart your camera if this occurs. It will automatically try to repair any damaged files and restore your camera back to full function.

## Important Messages

---



### REPAIRING YOUR FILE

Your GoPro will automatically try to fix damaged files. Files can be damaged if your camera loses power while recording or if there's a problem saving the file. The File Repair icon will appear on the touch screen when a repair is in progress. Your camera will let you know when it's finished and if the file was fixed.

### MEMORY CARD FULL

Your camera will let you know when your SD card is full. You'll need to move or delete some files if you want to keep recording.

### SD CARD RATING

Your camera needs an SD card rated A2 V30, UHS-3, or higher to operate at its best. It will let you know if your card is rated too low or if your card has degraded over time and can no longer perform up to its standards.

### BATTERY LOW, POWERING OFF

A low-battery message will appear on the touch screen when the battery charge drops below 10%. If the charge runs out while recording video, your camera will stop recording, save the video, and turn itself off.

## Resetting Your Camera

---

### RESTARTING YOUR GOPRO

If your camera is not responding, press and hold the Mode button  for 10 seconds. This will restart your camera. There will be no changes to your settings.

### RESTORE PRESETS TO THE DEFAULTS

This will reset all of your camera's original preset settings to the defaults.

1. Swipe down on the rear screen to access the Dashboard.
2. Swipe left and tap Preferences > Reset > Reset Presets.

*Heads Up:* Restoring your camera's original preset settings to their defaults will delete your custom presets.

### RESETTING CONNECTIONS

This will clear your device connections and reset your camera's password. Resetting connections means you'll have to reconnect all of your devices.

1. Swipe down on the rear screen to access the Dashboard.
2. Swipe left and tap Preferences > Wireless Connections > Reset Connections.

### RESETTING THE CAMERA TIPS

Want to see the camera tips again? Here's how to see them all from the beginning.

1. Swipe down on the rear screen to access the Dashboard.
2. Swipe left and tap Preferences > Reset > Reset Camera Tips.



## Resetting Your Camera

---

### RESTORING FACTORY SETTINGS

This will restore all of your camera's original settings, clear all device connections, and deregister your camera from your GoPro subscription. This is useful if you're giving your camera to a friend and want to completely reset it to its original state.

1. Swipe down on the rear screen to access the Dashboard.
2. Swipe left and tap Preferences > Reset > Factory Reset.

*Heads Up:* Restoring the factory settings will not delete any content from your SD card or have any effect on your camera's software.

## Mounting Your GoPro

---



1



2



3

### MOUNTING HARDWARE

1. Mounting Buckle
2. Thumb Screw
3. Curved Adhesive Mount

## Mounting Your GoPro

---

### USING THE MOUNTING FINGERS

Depending on the mount you're using, you'll either attach the mounting fingers to a mounting buckle or attach them directly to the mount itself.

See [Using the Adhesive Mounts \(page 100\)](#) for tips on using adhesive mounts.

1. Flip the folding fingers down into the mounting position.
2. Interlock the folding fingers on your camera with the mounting fingers on the buckle.
3. Secure your camera to the mounting buckle with a thumb screw.

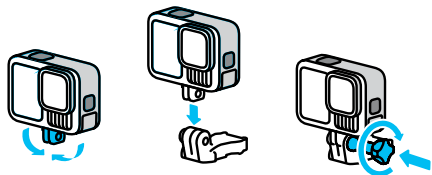

## Mounting Your GoPro

---

4. Attach the mounting buckle to the mount.

- a. Flip up the mounting buckle plug.
- b. Slide the buckle into the mount until it clicks into place.
- c. Press the plug back down so that it sits flush with the buckle.

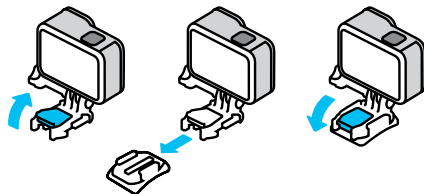

**PRO TIP:** Use the mounting fingers to securely attach your camera to GoPro mounts when you need durable mounting during high-vibration activities and in rough conditions.

### 1/4-20 MOUNTING

In addition to the mounting fingers, your GoPro has 1/4-20 mounting threads. This makes it compatible with most standard camera mounts and accessories.



**WARNING:** Your GoPro could become loose or be dislodged when used with 1/4-20 mounts under extreme conditions. Use the mounting fingers for more secure mounting in extreme conditions.

## Mounting Your GoPro

---

### MAGNETIC LATCH MOUNTS

The Magnetic Latch Mount and Magnetic Latch Ball Joint Mount (both sold separately) are the easiest ways to mount your GoPro. Simply attach them to a handheld grip, body mount, or other gear setup. Powerful magnets help line up your GoPro so all you have to do is snap it in place. A squeeze of the auto-engage latches is all you need to detach your GoPro, making it faster than ever to swap it between your favorite mounts.

### USING THE ADHESIVE MOUNTS

Follow these guidelines when attaching adhesive mounts to helmets, vehicles, and gear:

- Attach mounts at least 24 hours before you use them.
- Only attach the mounts to smooth surfaces. They won't stick properly to porous or textured surfaces.
- Firmly press mounts into place. Be sure the adhesive is in full contact with the surface.
- Only use on clean, dry surfaces. Wax, oil, dirt, or other debris will weaken the bond, and you could lose your camera.
- Attach mounts in dry, room-temperature conditions. They won't stick properly in cold or damp environments or on cold or damp surfaces.
- Check state and local regulations and laws to ensure that attaching a camera to equipment (such as hunting gear) is permitted. Always comply with regulations that restrict the use of consumer electronics or cameras.



**WARNING:** To avoid injury, do not use a tether when mounting your camera on a helmet. Do not mount the camera directly on skis or snowboards.

---

## Mounting Your GoPro

---

**WARNING:** Always use a helmet that meets applicable safety standards if you're using a GoPro helmet mount or strap.



Choose the right helmet for your sport or activity, and make sure that it's the right size and fit for you. Check to see that your helmet's in good condition, and always follow the manufacturer's instructions on safe use.

Replace any helmet that's been subjected to a major impact. No helmet can protect against injury in every accident. Be safe.

---

For more information about mounts, visit [gopro.com](https://gopro.com).

## Using Your GoPro in + Around Water



---

### USING YOUR GOPRO IN + AROUND WATER

Your GoPro is waterproof to 33ft (10m) with the door locked. You won't need additional housing before diving in.

**PRO TIP:** Make sure that the door seal is completely free of debris and that the door is securely shut before using your GoPro in and around water. Use a cloth to clean the seal if needed before shutting the door. Dirt, sand, or other debris on the seal could cause water to leak into your camera.

The touch screen was designed to work when wet, but you may need to wipe it off if it has trouble sensing your commands. Although it will not work under water, you can use the camera's buttons to navigate the menus when you're submerged.

1. With the camera on, you can press the Mode button  to switch modes.
2. Hold down the Mode button and press the Shutter button . A menu will appear on the front screen.
3. Press the Mode button to scroll through the presets.
4. Use the Shutter button to select a preset.

*Heads Up:* The Dashboard and Media Gallery are not available when navigating with the buttons. To capture extreme adventures down to 196ft (60m), pick up the Protective Housing (HERO13 Black), sold separately.

## Removing the Door

---

There might be times when you need to remove your camera's door.

**NOTE:** Only remove the door in a dry, dust-free environment. The camera is not waterproof when the door is open or removed.

### REMOVING THE DOOR

1. Unlock the latch, and then flip the door open.
2. With the door in a horizontal position, gently pull outward until it snaps off.

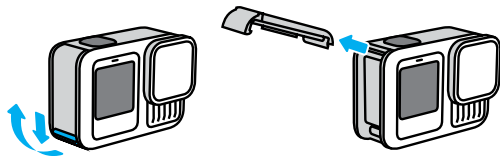

**WARNING:** Avoid using your GoPro with the door off. The battery could slide out during use.

## Removing the Door

---

### REATTACHING THE DOOR

1. Line the door up with the small silver bar.
2. Press the door tightly into the small silver bar until it snaps into place and is securely attached.

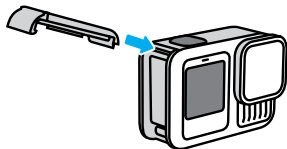

**WARNING:** Your camera's door is removable. Be sure that the door is securely locked and sealed after closing.

---

## Maintenance

---

Follow these tips to get the best performance from your camera:

- Your GoPro is waterproof to 33ft (10m)—no housing needed. Be sure the door is closed before using it in or around water, dirt, or sand.
- Before closing the door, be sure the seal is free of debris. Use a cloth to clean the seal if needed.
- Make sure your GoPro is dry and clean before opening the door. Rinse your camera with fresh water and dry it with a cloth if needed.
- If sand or debris hardens around the door, soak your camera in warm tap water for 15 minutes and then rinse thoroughly to remove the debris. Make sure your camera is dry before opening the door.
- For the best audio performance, shake your camera or blow on the mic to remove water and debris from the microphone holes. Do not use compressed air to blow into the mic holes. This could damage the internal waterproof membranes.
- After every use in salt water, rinse your camera with fresh water, and dry it with a soft cloth.
- The lens cover is made from extremely tough strengthened glass, but it can still be scratched or cracked. Keep it clean with a soft, lint-free cloth.
- If debris gets stuck between the lens and trim ring, flush it out with water or air. Do not insert foreign objects around the lens.

## Battery Information

---

### MAXIMIZING BATTERY LIFE

Here are some things you can do to maximize battery life:

- Capture video at lower frame rates and resolutions.
- Use the Screensaver and lower the screen Brightness.
- Turn off the front screen.
- Turn off Wireless Connections.
- Turn off GPS.
- Record with QuikCapture.
- Choose a shorter Auto Power Off setting.

### RECORDING WHEN PLUGGED INTO A POWER SOURCE

You can use the USB-C cable that came with your camera to shoot videos and photos while your camera is plugged into a USB-charging adapter or other external power source. This is perfect for capturing long videos and time lapse events.

Be careful not to touch the area near the SD card slot when recording. Disturbing the SD card could interrupt or stop the recording. Your camera will let you know if this happens. Your content will not be damaged or lost as a result of this disturbance, but you may need to restart your camera to continue.

Even though your camera is charging, the battery will not charge during recording. It will start charging when you stop recording. You cannot record while your camera is plugged into a computer.

*Heads Up:* Because the door is open, your camera is not waterproof when charging.

## Battery Information

---

### CHARGING THROUGH THE DOOR

GoPro has 2 solutions that let you conveniently power your camera through long capture sessions or charge your battery while keeping the door closed. The Contacto Magnetic Door and Power Cable Kit (sold separately) features a cable that magnetically attaches to a replacement camera door to form a tight weatherproof seal. Plug the other end of the cable into any USB-C power source (make sure your power source is waterproof when using in wet conditions).

The USB Pass-Through Door (sold separately) lets you plug directly into your camera's USB-C port through the door. This keeps your camera weather resistant during exceptionally long shoots and makes it easier to keep your battery charged.

---

**PRO TIP:** Use the Contacto Magnetic Door and Power Cable Kit (sold separately) to keep your camera weather resistant and the battery in place when plugged into an external power source.



**WARNING:** Only use an agency-approved power supply which meets local regulatory requirements (e.g. UL, CSA, VDE, CCC) to charge your GoPro. Using non-compliant power adapters and cables could damage your camera battery and could lead to fire or leakage.

---

## Battery Information

---

### BATTERY STORAGE + HANDLING

Your GoPro is full of sensitive components, including the battery. Avoid exposing your camera to very hot or cold temperatures. Extreme temperatures may temporarily shorten battery life or cause your camera to temporarily stop working properly. Avoid dramatic temperature or humidity changes, as condensation may form on or within the camera.

Do not dry your camera with an external heat source such as a microwave oven or a hair dryer. Damage to the camera or battery caused by contact with liquid inside the camera is not covered under the warranty.

Do not store your battery with metal objects like coins, keys, or necklaces. If the battery terminals come in contact with metal objects, this may cause a fire.

Do not make any unauthorized alterations to your camera. Doing so may compromise safety, regulatory compliance, and performance, and may void the warranty.

*Heads Up:* Batteries have reduced capacity in cold weather. This affects older batteries even more. If you regularly shoot at low temperatures, replace batteries yearly for optimal performance.

---

**PRO TIP:** Fully charge your camera before storing it away to help maximize battery life.

## Battery Information

---



**WARNING:** Do not drop, disassemble, open, crush, bend, deform, puncture, shred, microwave, incinerate, or paint your camera or battery. Do not insert foreign objects into any opening on the camera, such as the USB-C port. Do not use your camera if it's been damaged—for example, if cracked, punctured, or harmed by water. Disassembling or puncturing the integrated battery can cause an explosion or fire.

### BATTERY DISPOSAL

Most rechargeable lithium-ion batteries are classified as non-hazardous waste and are safe for disposal in the normal municipal waste stream. Many regions require battery recycling. Check your local laws to make sure that you can dispose of rechargeable batteries in your regular trash. To safely dispose of lithium-ion batteries, protect terminals from exposure to other metal with packing, masking, or electrical tape so they do not cause a fire while being transported.

Lithium-ion batteries, however, do contain recyclable materials and are accepted for recycling by the Rechargeable Battery Recycling Corporation's (RBRC) Battery Recycling Program. We encourage you to visit Call2Recycle at [call2recycle.org](http://call2recycle.org) or call 1-800-BATTERY in North America to find a convenient recycling location.

Never dispose of a battery in a fire because it may explode.



**WARNING:** Only use GoPro replacement batteries, power cables, and battery charging accessories or devices with your camera.

Using an older GoPro battery or non-GoPro battery could greatly limit your camera's performance, will void your warranty, and may cause fire, electric shock or other safety risk.

## Troubleshooting

---

### MY GOPRO WON'T POWER ON

Make sure your GoPro is charged. See [SD Card + Battery Setup \(page 10\)](#). If charging the battery doesn't work, try restarting your camera. See [Restarting Your GoPro \(page 95\)](#).

### MY GOPRO WON'T RESPOND WHEN I PRESS A BUTTON

See [Restarting Your GoPro \(page 95\)](#).

### PLAYBACK ON MY COMPUTER IS CHOPPY

Choppy playback is usually not a problem with the file. If your footage skips, one of these issues is probably the cause:

- The computer doesn't work with HEVC files. Try downloading the latest version of the GoPro Player for Mac® or Windows® for free at [gopro.com/apps](https://gopro.com/apps).
- Your computer doesn't meet the minimum requirements of the software you're using for playback.

## Troubleshooting

---

### I FORGOT MY CAMERA'S USERNAME OR PASSWORD

Swipe down on the rear screen to access the Dashboard, swipe left, and then tap Preferences > Connections > Camera Info.

### I DON'T KNOW WHICH SOFTWARE VERSION I HAVE

Swipe down on the rear screen to access the Dashboard, swipe left, and then tap Preferences > About > Camera Info.

### I CAN'T FIND MY CAMERA'S SERIAL NUMBER

The serial number is stamped inside the battery compartment of your camera. You can also find it by swiping down on the rear screen to access the Dashboard, swiping left, and then tapping Preferences > About > Camera Info.

### I CAN'T FIND MY GOPRO

Tap "Locate Camera" in the GoPro Quik app. Your GoPro will start beeping if its in Bluetooth® range and connected to the app.

For more answers to commonly asked questions, see [gopro.com/help](https://gopro.com/help).



## Tech Specs: Video

---

### VIDEO QUALITY OPTIONS (EASY CONTROLS)

There are 3 recording options in Video mode. Each works by pressing the Shutter button  to start recording, and then pressing it again to stop.

#### Highest

Captures your adventure in our highest resolution 5.3K video that delivers pro-quality footage with 91% more resolution than 4K.

*Heads Up:* Some footage may be recorded in a lower resolution depending on the digital lens and slo-mo combination selected.

#### Standard (Default)

Captures pro-quality footage with 4K video resolution that makes it ideal for mobile devices that struggle to playback higher-resolution video.

*Heads Up:* Some footage may be recorded in a lower resolution depending on the digital lens and slo-mo combination selected.

#### Basic

Captures full HD 1080p video while also maximizing battery life and compatibility with older devices.

## Tech Specs: Video

---

### STANDARD, HDR, HLG HDR + LOG VIDEO

Your GoPro gives you the option to record standard, HDR, HLG HDR or Log video.

#### Standard

Records footage using the standard video format.

#### HDR

Records 5.3K and 4K video using High Dynamic Range (HDR) to capture dynamic footage with true-to-life color and precision. Brings out the subtle details in scenes that might typically blend into the darkness of shadows or disappear into the bright spots of a shot. Best when used in bright environments.

#### HLG HDR

Hybrid Log Gamma (HLG) is available after you turn it on using Protune. It's a standard HDR format that media professionals use to capture video in the 10-bit and Rec. 2100 color space.

*Heads Up:* Videos recorded with HLG HDR require a compatible display and media player for playback.

#### Log

Use Log video to get more detail in your footage. All video recorded with Log encoding will use the GP-Log color profile and must be color corrected in post-production. This gives you more flexibility and control of dynamic range. A Lookup Table (LUT) will be generated to help you with color grading.

*Heads Up:* Log video will only be available when choosing 10-Bit encoding for your videos.

1. Swipe down on the rear screen to access the Dashboard.
2. Swipe left and tap Preferences > Video > Bit Depth.

## Tech Specs: Video

---

### FRAMING (VIDEO)

Framing refers to the width and height of an image. It's also referred to as aspect ratio. Your GoPro captures videos in 4 aspect ratios.

#### 16:9 (Widescreen)

This is the standard format used for HDTV, YouTube, and editing programs. The widescreen format is ideal for capturing dramatic, cinematic footage.

#### 9:16 (Vertical)

This extra-tall format is ideal for watching content on your phone and posting to social media.

#### 4:3 (Traditional)

The tall 4:3 format captures more of the scene than the 16:9 widescreen format. It's great for selfies and immersive point-of-view footage.

#### 8:7 (Full Frame)

This ultra immersive format is the tallest and widest field of view ever on a GoPro HERO camera—allowing you to capture more of the scene in each shot. This lets you zoom in and focus on chosen sections of your footage to create high-resolution punchouts of the action in any aspect ratio, while cropping out the rest of the shot using the GoPro Quik app or other editing software.

## Tech Specs: Video

---

### VIDEO RESOLUTION (RES)

Video resolution refers to the level of detail in each frame of video. The higher the resolution, the better the image quality. A 5.3K video features 91% more resolution than 4K video and 665% more than 1080p.

Video Resolution	Description
5.3K 16:9	Ultra high-resolution video that captures breathtaking ultra HD video in the wide 16:9 aspect ratio. Can be used to grab 15.8MP stills from your video.
5.3K 8:7	Ultra high-resolution video that captures the tallest and widest field of view ever on a HERO camera. This gives you the flexibility to create widescreen (16:9) and vertical (9:16) punchouts of your footage without losing any image quality. You can also zoom in on shots while keeping the rich textures and sharpness of your footage and grab 24.7MP stills from your video.
4K 16:9	Ultra HD video with 16:9 aspect ratio. Great for tripod and fixed-position shots. Can be used to grab 8MP stills from your video.
4K 8:7	Ultra HD video in the extra tall and wide 8:7 aspect ratio. Great for capturing immersive POV footage that lets you change digital lenses, crop your shot, and adjust aspect ratios after recording. Can be used to grab 12.9MP stills from your video.

## Tech Specs: Video

---

Video Resolution	Description
4K 9:16	Ultra HD video with an extra-tall 9:16 aspect ratio that's ideal for playback on your phone or posting on social media. Can be used to grab 8MP stills from your video.
2.7K 16:9	High resolution 16:9 video that provides stunning, cinema-quality results for professional productions. High 120 fps frame rate enables 4x slo-mo during editing.
2.7K 4:3	Great for high-resolution point-of-view body and gear-mounted shots with fluid slo-mo playback.
1080p 16:9	Standard HDTV resolution that's ideal when you want to maximize recording time or plan on playing back your video on older devices. High 240 fps and 120 fps options enable super slo-mo during editing.
1080p 9:16	Standard HDTV resolution in the extra-tall 9:16 aspect ratio. Best for maximizing recording time, playing back on older devices, and creating smaller file sizes for posting to social media.

## Tech Specs: Video

---

### FRAMES PER SECOND (FPS)

Frames per second refers to the number of frames captured in each second of video. Higher fps values (60, 120, or 240) are better at capturing fast-action shots. You can also use high fps footage for slow-motion playback.

### Slo-Mo + FPS

Normal speed video is typically captured and played back at 30 fps. As a result, video that is captured at 60 fps can be played back at 2x slow motion (1/2 speed). Video that is recorded at 120 fps can be played back at 4x slow motion (1/4 speed), and video recorded at 240 fps can be played back at 8x slow motion (1/8 speed).

Videos recorded at a higher fps will also have more fluid motion with greater detail when watched in slow motion.

### Resolution + FPS

Higher video resolutions capture more detail and clarity, but they're generally available at lower fps values.

Lower video resolutions capture less detail and clarity, but they can be shot at higher fps values.

## Tech Specs: Video

---

### DIGITAL LENSES (VIDEO)

Digital lenses let you choose how much of the scene is captured by your camera. The different lenses also affect the zoom level and the fisheye effect in your shot.

Digital Lens	Description
	Our tallest and widest field of view. Great for capturing immersive point-of-view footage.
HyperView (16mm)	<i>Heads Up:</i> HyperView stretches 8:7 footage to fit a 16:9 screen. The result is ultra immersive footage with a fish-eye effect. It's best used for POV action sports footage rather than general recording.
SuperView (16mm)	Tall field of view that's great for POV shots with less distortion than HyperView.
Wide (16–34mm)	Wide, versatile field of view that's great for everyday shots and selfies.

## Tech Specs: Video

---

Digital Lens	Description
Linear + Horizon Lock / Horizon Leveling (19–33mm)	Wide field of view without the fisheye effect of HyperView, SuperView, or Wide. Keeps your footage smooth and level even if your camera rotates while recording.  To learn more, see <a href="#">Horizon Lock / Horizon Leveling (starting page 123)</a> .
Linear (19–39mm)	Wide field of view without the fisheye effect. Great for landscape and scenic shots.

*Heads Up:* Only the lenses that are compatible with the resolution and frame rate you selected will be available.

**PRO TIP:** Use the Ultra Wide Lens Mod (sold separately) to boost your field of view with an ultra wide 177° digital lens.

## Tech Specs: Video

### VIDEO SETTINGS

Here's a full rundown of your camera's video resolutions, frame rates (fps), digital lenses, and aspect ratios in Highest Quality video mode.

Video Resolution (RES)	FPS (60Hz/50Hz)*	Digital Lenses	Screen Resolution	Aspect Ratio
5.3K	60/50	SuperView, Wide, Linear, Linear + Horizon Leveling	5312x2988	16:9
5.3K	30/25 24/24	HyperView, SuperView, Wide, Linear, Linear + Horizon Lock	5312x2988	16:9
5.3K	30/25 24/24	Wide	5312x4648	8:7
4K	120/100	SuperView, Wide, Linear, Linear + Horizon Leveling	3840x2160	16:9
4K	60/50 30/25 24/24	HyperView, SuperView, Wide, Linear, Linear + Horizon Lock	3840x2160	16:9

## Tech Specs: Video

Video Resolution (RES)	FPS (60Hz/50Hz)*	Digital Lenses	Screen Resolution	Aspect Ratio
4K	60/50 30/25 24/24	Wide	3840x3360	8:7
4K	60/50 30/25	Wide	2160x3840	9:16
2.7K	240/200	Wide, Linear, Linear + Horizon Leveling	2704x1520	16:9
2.7K	120/100	Wide, Linear, Linear + Horizon Lock	2704x2028	4:3
1080p	240/200	Wide, Linear, Linear + Horizon Leveling	1920x1080	16:9
1080p	120/100 60/50 30/25	SuperView, Wide, Linear, Linear + Horizon Lock	1920x1080	16:9
1080p	60/50 30/25	Wide	1080x1920	9:16

\*60Hz (NTSC) and 50Hz (PAL) refer to the video format, which depends on your region. To learn more, see [Regional Format \(page 90\)](#).

## Tech Specs: Video

---

### HIGH RESOLUTIONS/HIGH FRAME RATES

Shooting high-resolution or high-fps video when it's warm out can cause your camera to heat up and use more power.

Lack of airflow and connecting to the GoPro Quik app can cause your camera to warm up even more, use even more power, and shorten recording time.

If heat's a problem, try recording shorter videos. Also limit use of features that take a lot of power, such as the GoPro Quik app. The Remote (sold separately) can control your GoPro while using less energy.

Your camera will tell you if it needs to shut down and cool off.

To learn more, see [Important Messages \(page 93\)](#).

## Tech Specs: Video

---

### HORIZON LOCK / HORIZON LEVELING

Your GoPro can give your videos the cinematic look of professional productions by keeping the horizon straight and level. Depending on the resolution and frame rate, your camera will record with either Horizon Lock or Horizon Leveling.

#### **Horizon Lock**

Horizon Lock keeps your footage locked and steady (on the horizontal or vertical axis) even if your camera rotates a full 360° while recording. It's available when recording 16:9 and 4:3 aspect ratio footage using most frame rates at each resolution.

#### **Horizon Leveling**

Horizon Leveling keeps your footage smooth and level even if your camera tilts while recording. It's available when recording 16:9 aspect ratio footage at the highest frame rate of each resolution (5.3K60, 4K120, 2.7K240, and 1080p240).

## Tech Specs: Video

---

### HYPERSMOOTH VIDEO STABILIZATION

HyperSmooth delivers ultra smooth footage by correcting for camera shake. It crops your videos while recording, which lets it buffer the footage. This makes it perfect for biking, skating, skiing, handheld shots, and more. Your GoPro has 3 HyperSmooth settings:

Setting	Description
AutoBoost	Combines maximum video stabilization with the widest field of view possible. Cropping varies based on the level of stabilization required for the shot.
On	High-level video stabilization with minimal cropping.
Off	Records without video stabilization or cropping.

You can smooth out your footage even more by using Touch Zoom to crop your shots before you start recording. This will give your camera an even bigger buffer to use when stabilizing your video. Using Horizon Lock will also enhance stabilization.

**PRO TIP:** Use the Ultra Wide Lens Mod (sold separately) to max out your GoPro with the ultimate in unbreakable video stabilization up to 4K at 60 frames per second.

## Tech Specs: Video

---

### BURST SLO-MO

Burst Slo-Mo pushes your GoPro to its limits by capturing short video clips at a blistering 400 frames per second. This lets you slow the action down to 13x normal speed on playback. Your GoPro gives you 3 Burst Slo-Mo options.

Video Resolution (RES)	FPS (60Hz/50Hz)*	Digital Lenses	Slo-Mo Speed	Maximum Duration
720p	400/400	Narrow	13x	15 sec
900p	360/300	Linear	12x	15 sec
5.3K	120/100	Wide	4x	5 sec

## Tech Specs: Photo

---

### ASPECT RATIO (PHOTO)

Aspect ratio refers to the width and height of an image. Your GoPro captures 27MP photos in the 8:7 aspect ratio. This ultra immersive format is the tallest and widest field of view ever on a GoPro HERO camera. The added height makes it perfect for creating extra-tall 9:16 vertical shots or any other size you need for any social media platform.

### Photo Editing With the GoPro Quik App

The 8:7 aspect ratio combines with the 27MP photo resolution to give you an extra-large canvas for your creativity. The GoPro Quik app features a variety of tools designed to make editing easy.

- Crop and zoom in on selected portions of your photos without losing the details in your shot.
- Switch digital lens effects to adjust the field of view of your photos.
- Change the aspect ratio of your shots.

### SUPERPHOTO

SuperPhoto automatically analyzes the scene and intelligently applies the best image processing for the shot.

Depending on the lighting, movement in your shot, and other conditions, SuperPhoto will choose one of 3 options:

#### High Dynamic Range (HDR)

Our improved HDR takes and combines multiple photos into a single shot to bring out the details in scenes that mix bright light and shadows.

## Tech Specs: Photo

---

### Multi-Frame Noise Reduction

Automatically combines multiple shots into a single photo with less digital distortion (noise).

### Standard Photo

Includes Local Tone Mapping, which enhances photos by boosting the details and contrast only where it's needed.

Because of the extra time needed to apply image processing, it may take a little longer to process and save each shot.

*Heads Up:* SuperPhoto does not work with Burst Photo, Night Photo, RAW photos, Protune, or Exposure Control.

### Turning SuperPhoto Off

SuperPhoto is on by default. Here's how to turn it off.

1. From the Photo settings screen, tap Output.
2. Switch to Standard, HDR, or RAW.

### HDR (PHOTO)

High Dynamic Range (HDR) is one of the image-processing techniques SuperPhoto uses to enhance your shots. It combines multiple shots into a single photo with better results than ever. Choose this setting if you want to use HDR every time you take a photo.

1. From the Photo settings, tap Output.
2. Select HDR.

For the best results, use HDR in high-contrast shots with minimal motion.

*Heads Up:* HDR does not work with Burst Photo, Night Photo, RAW photo, or Exposure Control.



## Tech Specs: Photo

---

### INTERVAL (INTERVAL PHOTO)

Interval sets how often your camera takes a photo while using Interval Photo. You can choose an interval of 0.5, 1, 2, 3, 5, 10, 30, 60, or 120 seconds. You can also choose to turn Interval Photo off.

*Heads Up:* Some intervals may not be available with the output you select. Your camera will suggest another interval that will work with the output you want.

### SHUTTER SPEED (NIGHT + NIGHT LAPSE PHOTO)

Shutter speed lets you decide how long your camera's shutter stays open in Night and Night Lapse Photo modes. Here are your options, plus tips on when to use them:

Speed	Examples
Auto (up to 30 seconds)	Sunrise, sunset, dawn, dusk, twilight, night.
2, 5, 10, or 15 seconds	Dawn, dusk, twilight, traffic at night, Ferris wheel, fireworks, light painting.
20 seconds	Night sky (with light).
30 seconds	Night stars, Milky Way (complete darkness).

**PRO TIP:** To reduce blur when using Night and Night Lapse photo, mount your camera on a tripod or place it on a stable surface where it won't wobble or shake.

## Tech Specs: Photo

---

### BURST RATE

Capture fast-action scenes with one of these high-speed settings:

- Auto (up to 30 photos in 1 second based on lighting conditions)
- 60 photos in 6 or 10 seconds
- 30 photos in 1, 3, or 6 seconds
- 10 photos in 1 or 3 seconds
- 5 photos in 1 second
- 3 photos in 1 second

### DIGITAL LENSES (PHOTO)

Digital lenses let you choose how much of the scene is captured by your camera. They also affect the zoom level and fisheye effect in your shot. There are 3 lens options for photos:

Digital Lens	Description
Wide (16–34mm)	Wide field of view that captures as much as possible within the frame.
Linear (19–39mm)	Wide field of view without the fisheye effect of Wide.

**PRO TIP:** Use the Ultra Wide Lens Mod (sold separately) to boost your field of view with an ultra wide 177° digital lens.

## Tech Specs: Photo

---

### RAW FORMAT

When this setting is turned on, all photos are saved as a .jpg image (for viewing on your camera or sharing with the GoPro Quik app) and a .gpr file.

The .gpr file is based on the Adobe® DNG format. These files can be used in Adobe Camera Raw (ACR), version 9.7 or later. You can also use Adobe Photoshop® Lightroom® CC (2015.7 release or later) and Adobe Photoshop® Lightroom® 6 (version 6.7 or later).

In Photo mode, RAW Format is available for Photo, Burst, Night, Time Lapse photo, and Night Lapse photo, with these conditions and exceptions:

- SuperPhoto must be off.
- Digital lenses must be set to Wide.
- Zoom must be off.
- RAW Format is not available for capturing continuous photos.
- For Time Lapse photo, the Interval must be at least 5 seconds.
- For Night Lapse photo, the Shutter setting must be at least 5 seconds.

---

**PRO TIP:** Photos in .gpr format are saved in the same location and with the same file name as .jpg files. To access the files, insert your SD card into a card reader and locate them with your computer's file explorer.

## Tech Specs: Time Lapse

---

### TIMEWARP VIDEO SPEED

You can increase TimeWarp video speed up to 30x to turn longer activities into shareable moments. The default setting is Auto, which automatically sets the speed for you.

You can also set the speed yourself. Use this chart to estimate the length of your videos. For example, recording at 2x speed for 4 minutes will give you about 2 minutes of TimeWarp video.

Speed	Recording Time	Video Length
2x	1 minute	30 seconds
5x	1 minute	10 seconds
10x	5 minutes	30 seconds
15x	5 minutes	20 seconds
30x	5 minutes	10 seconds

*Heads Up:* Recording times are approximate. The video length may vary depending on the movement in your shot.

Speed	Examples
2x–5x	Driving through a scenic route.
10x	Hiking and exploring.
15x–30x	Running and mountain biking.

**PRO TIP:** For the best results, leave the speed on the Auto setting when shooting footage that may get bumpy.

## Tech Specs: Time Lapse

---

### SPEED RAMP (TIMEWARP)

Speed Ramp works by cranking down your TimeWarp from the speed you selected for your video to 30 frames per second (real speed). Simply start recording your TimeWarp video. During recording, tap the rear touch screen to slow down to real speed to capture or create a dramatic moment. Tap again to speed it back up.

In your video, the high-speed action will slow down to real speed during the time you used Speed Ramp and will speed back up at the time you turned Speed Ramp off.

## Tech Specs: Time Lapse

---

### TIME LAPSE SETTINGS

Here's a full rundown of your camera's time lapse available resolutions, digital lenses, and aspect ratios.

Time Lapse Mode	Video Resolution (RES)	Digital Lens	Aspect Ratio
TimeWarp	5.3K, 4K, 1080P	HyperView, SuperView, Wide, Linear, Linear + Horizon Lock	16:9, 8:7
TimeWarp	4K, 1080P	HyperView, SuperView, Wide, Linear, Linear + Horizon Lock	9:16
Star Trails	5.3K, 4K	Wide	16:9, 8:7
Light Painting	5.3K, 4K	Wide	16:9, 8:7
Vehicle Light Trails	5.3K, 4K	Wide	16:9, 8:7
Time Lapse Video	5.3K, 4K, 1080P	Wide, Linear	16:9, 8:7
Night Lapse Video	5.3K, 4K, 1080P	Wide, Linear	16:9, 8:7

## Tech Specs: Time Lapse

---

### TIME LAPSE INTERVAL

The Interval sets how often your camera takes a shot in Time Lapse video and Time Lapse photo modes.

Available intervals are 0.5 (default), 1, 2, 5, 10, and 30 seconds; 1, 2, 5, and 30 minutes; and 1 hour.

Interval	Examples
0.5–2 seconds	Surfing, biking, or other sports.
2 seconds	Busy street corner.
5–10 seconds	Clouds or outdoor scenes for long durations.
10 seconds–1 minute	Art projects or other lengthy activities.
1 minute–1 hour	Construction work or other activities that take place over a very long period of time.

## Tech Specs: Time Lapse

---

### TIME LAPSE VIDEO RECORDING TIME

Use this chart to determine the length of your videos.

Interval	Recording Time	Video Length
0.5 seconds	5 minutes	20 seconds
1 second	5 minutes	10 seconds
2 seconds	10 minutes	10 seconds
5 seconds	1 hour	20 seconds
10 seconds	1 hour	10 seconds
30 seconds	5 hours	20 seconds
1 minute	5 hours	10 seconds
2 minutes	5 hours	5 seconds
5 minutes	10 hours	4 seconds
30 minutes	1 week	10 seconds
1 hour	1 week	5 seconds

**PRO TIP:** For the best results, mount your camera on a tripod or place it on a stable surface where it won't wobble or shake. Use TimeWarp video to capture time lapse video when you're on the move.

## Tech Specs: Time Lapse

---

### NIGHT LAPSE INTERVAL

Choose how often your GoPro snaps a shot in Night Lapse mode. Night Lapse intervals are Auto; 4, 5, 10, 15, 20, and 30 seconds; and 1, 2, 5, 30, and 60 minutes.

Auto (default) syncs the Interval with the Shutter setting. If the shutter speed is set to 10 seconds and the Interval is set to Auto, your camera will take a shot every 10 seconds.

Interval	Examples
Auto	Great for all exposures (captures as quickly as possible depending on the Shutter setting).
4–5 seconds	Evening city scene, street lighting, or scenes with movement.
10–15 seconds	Dim lighting with slow scene changes, such as night clouds with a bright moon.
20–30 seconds	Very low light or very slow scene changes, like stars with minimal ambient or street light.

## Tech Specs: Protune

---

Protune unlocks your camera's full creative potential by giving you manual control of advanced settings, including Color, White Balance, and Shutter Speed. It's compatible with professional color correction tools and other editing software.

Here are some things to keep in mind:

- Scroll down in the settings menu to see all of the Protune settings.
- Some Protune settings are not available when you use Exposure Control.
- Changes to Protune settings in one preset apply only to that preset. For example, changing the White Balance for Time Lapse does not affect White Balance for Burst photos.

---

**PRO TIP:** You can restore all Protune settings to their defaults by tapping  in the settings menu.

### HLG HDR

It's a standard HDR format that media professionals use to capture 5.3K and 4K video in the 10-bit and Rec. 2100 color space. Hybrid Log Gamma (HLG) is available after you turning it on using Protune. By selecting HLG HDR, the Bit Depth will be automatically set to 10-bit. It will stay at 10-bit until you switch to capturing in the Standard profile with a 8-bit bit Depth.

*Heads Up:* Videos recorded with HLG HDR require a compatible display and media player for playback.

## Tech Specs: Protune

---

### BIT DEPTH

Choose between capturing 8-bit or 10-bit video. Capable of displaying over 1 billion colors, 10-bit color delivers enhanced color depth, smoother gradations and more realism in your videos, while 8-bit offers smaller file sizes.

1. Swipe down on the rear screen to access the Dashboard.
2. Swipe left and tap Preferences > Video > Bit Depth.

Bit Depth	Description
8-Bit (default)	Uses 8-bit HEVC encoding on all videos.
10-Bit	Uses 10-bit HEVC encoding on all videos 4K and higher for more post-production flexibility and color depth. All videos under 4K will use 8-bit encoding. Also enables Log Profile with GP-Log color profile.

*Heads Up:* Be sure that your devices are capable of playing back 10-bit HEVC content before using this setting. 10-bit encoding is not available for 9:16 aspect ratio footage.

## Tech Specs: Protune

---

### BIT RATE

Bit rate determines the amount of data used to record a second of video. Choose between standard or high.

1. Swipe down on the rear screen to access the Dashboard.
2. Swipe left and tap Preferences > Video > Bit Rate.

Bit Rate	Description
Standard (default)	Use a lower bit rate to minimize file sizes.
High	Use higher bit rates up to 120Mbps (5.3K and 4K video) for optimal image quality.

### SHUTTER

The Protune Shutter setting only applies to the Video and Photo modes. This setting determines how long the shutter stays open. Scroll between the options to see a live preview of each setting, and then tap the one you want. The default setting is Auto.

For Photo, the options are Auto; and 1/125, 1/250, 1/500, 1/1000, and 1/2000 seconds.

For Video, the options depend on the fps setting, as shown below.

Shutter	Example 1: 1080p30	Example 2: 1080p60
Auto	Auto	Auto
1/fps	1/30 sec	1/60 sec
1/(2xfps)	1/60 sec	1/120 sec

## Tech Specs: Protune

---

1/(4xfps)	1/120 sec	1/240 sec
1/(8xfps)	1/240 sec	1/480 sec
1/(16xfps)	1/480 sec	1/960 sec

**PRO TIP:** To reduce the amount of blur in videos and photos when using the Shutter setting, mount your camera on a tripod or other stable surface where it won't wobble or shake.

### EXPOSURE VALUE COMPENSATION (EV COMP)

Exposure Value Compensation affects the brightness of your photos and videos. Adjusting this setting can improve image quality when shooting scenes with sharply contrasting lighting conditions.

Options for this setting range from -2.0 to +2.0. The default setting is -0.5.

Scroll between the options on the right side of the EV Comp screen to see a live preview of each setting, and then tap the one you want. Higher values result in brighter images.

*Heads Up:* For Video, this setting is available only if the Shutter is set to Auto.

You can also adjust the exposure based on a certain area of your scene. To learn more, see [Exposure Control \(page 62\)](#).

---

**PRO TIP:** EV Comp adjusts brightness within the existing ISO setting. If brightness has already reached the ISO setting in a low-light environment, increasing the EV Comp does not have any effect. To continue increasing the brightness, select a higher ISO value.

## Tech Specs: Protune

---

### WHITE BALANCE

White Balance lets you adjust the color temperature of videos and photos to optimize for cool or warm lighting conditions. Scroll between the options to see a live preview of each setting, and then tap the one you want.

Options for this setting are Auto (default), 2300K, 2800K, 3200K, 4000K, 4500K, 5000K, 5500K, 6000K, 6500K, and Native. Lower values will give you warmer tones.

You can also choose Auto to let your GoPro set the White Balance or the Native setting to create a minimally color-corrected file that allows for more precise adjustments in post-production.

## Tech Specs: Protune

---

### ISO MINIMUM/MAXIMUM

ISO Minimum and ISO Maximum let you set a range for the camera's sensitivity to light and image noise. Image noise refers to the degree of graininess in the shot.

In low light, higher ISO values result in brighter images but with more image noise. Lower values result in darker images with less image noise. Scroll between the options to see a live preview of each setting, and then tap the one you want.

ISO Maximum and Minimum can also be set to Auto when recording video. This is especially useful when shooting in environments with fluctuating lighting conditions

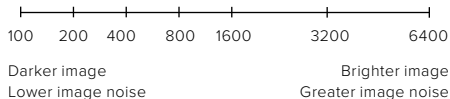

*Heads Up:* For the Video and Photo modes, ISO behavior depends on the Protune Shutter setting. The ISO Maximum that you select is used as the maximum ISO value. The ISO value that is applied might be lower depending on the lighting conditions.

---

**PRO TIP:** To lock the ISO at a specific value, set ISO Minimum and ISO Maximum to the same values.

## Tech Specs: Protune

---

### SHARPNESS

Sharpness controls the quality of details captured in your video footage or photos. Options for this setting are High, Medium (default), and Low.

Scroll between the options to see a live preview of each setting, and then tap the one you want.

---

**PRO TIP:** If you plan to increase sharpness during editing, select Low for this setting.

### DENOISE

Denosing is a process that reduces the amount of video noise in your footage. Digital noise can be the result of lighting conditions in the scene and other factors that show up as distortion and discoloration in your footage. You can set your GoPro denoise level to Low, Medium, or High.



## Tech Specs: Protune

---

### COLOR

Color lets you adjust the color profile of your videos or photos. Scroll between the options to see a live preview of each setting, and then tap the one you want.

Color Setting	Description
Natural (default)	Captures photos and videos with a true-to-life color profile.
Vibrant	Captures photos and videos with a color-saturated profile.
Flat	Provides a neutral color profile that can be color-corrected to better match footage captured with other equipment, offering more flexibility in post-production. Due to its long curve, Flat captures more details in shadows and highlights.

## Tech Specs: Audio

---

### RAW AUDIO

This setting creates a separate .wav file for your video, in addition to the standard .mp4 audio track. You can select the level of processing to apply to the RAW audio track.

RAW Setting	Description
Off (default)	No separate .wav file is created.
Low	Applies minimal processing. Ideal if you want to apply audio processing in post-production.
Med	Applies moderate processing based on the Wind-Noise Reduction setting. Ideal if you want to apply your own gain.
High	Applies full audio processing (automatic gain and Wind-Noise Reduction). Ideal if you want processed audio without AAC encoding.

Insert your SD card into a card reader to access the .wav files with your computer. They're saved with the same name and in the same location as the .mp4 files.

## Tech Specs: Audio

---

### AUDIO TUNING

Audio Tuning lets you adjust sound recording to better fit what you're capturing—whether it's the bustle of a busy marketplace, the sounds of nature, or a chat between you and your friends.

Setting	Description
Standard (default)	Tunes audio recording to capture balanced true-to-life sound that's great for most shots.
Voice	Tunes audio recording for enhanced vocal clarity while also preserving ambient background sounds.

### WIND SUPPRESSION

Your HERO13 Black uses 3 microphones to capture sound while recording video. You can customize how they're used based on conditions where you're shooting and the type of sound you want in your finished video.

Setting	Description
Auto (default)	Automatically filters out excessive wind (and water) noise.
On	Use to filter out excessive wind noise or when your GoPro is mounted on a moving vehicle.
Off	Use when wind will not affect sound quality and you want to ensure that your GoPro is recording in stereo.

## Tech Specs: Audio

---

### MEDIA MOD

Choose the audio setting you want to use with the Media Mod's (sold separately) built-in directional microphone.

*Heads Up:* An audio meter will appear onscreen when using your GoPro with a Media Mod.

Setting	Description
Front (default)	Use the Media Mod directional mic to prioritize audio coming from in front of the camera.
Back	Use the Media Mod directional mic to prioritize audio coming from behind the camera.
Camera Mics	Utilizes the camera's internal microphones. Use when wind is not a factor, and you want to ensure that your GoPro records in stereo.
Front + Back Mics	Records mono audio from the front and rear of the camera.

## Customer Support

---

GoPro is dedicated to providing the best possible service. To reach GoPro Customer Support, visit [gopro.com/help](https://gopro.com/help).

## Trademarks

---

GoPro, HERO and their respective logos are trademarks or registered trademarks of GoPro, Inc. in the United States and other countries. The Bluetooth word mark and logos are registered trademarks owned by Bluetooth SIG, Inc., and any use of such marks is under license. All other trademarks are the property of their respective owners. © 2024 GoPro, Inc. All rights reserved. For patent information, visit [gopro.com/patents](https://gopro.com/patents). GoPro, Inc., 3025 Clearview Way, San Mateo CA 94402 | GoPro GmbH, Baierbrunner Str. 15 Bldg. D, 81379 Munich, Germany

## Regulatory Information

---

To see the complete list of country certifications, refer to the Important Product + Safety Instructions included with your camera or visit [gopro.com/help](https://gopro.com/help).

