

**DENON<sup>®</sup>**

**DENON HOME 150 NV**

WIRELESS SPEAKER

**Owner's Manual**



<b>Accessories</b>	<b>4</b>
<b>Part names and functions</b>	<b>5</b>
Front panel	5
Top panel	6
Rear panel	7
<b>Placing</b>	<b>8</b>
Wall or ceiling mounting	8
<b>Powering your speaker</b>	<b>9</b>
<b>Getting the HEOS app</b>	<b>10</b>

## Setup

<b>Setting up the HEOS app for the first time with a HEOS built-in device</b>	<b>11</b>
<b>Adding the registration of HEOS built-in devices in the HEOS app</b>	<b>12</b>
Adding wired HEOS built-in devices	12
Adding wireless HEOS built-in devices	13
<b>HEOS account</b>	<b>14</b>

## Playback

<b>Playing from streaming music services</b>	<b>15</b>
Selecting a room/device	15
Selecting the music track or station from music sources	16
<b>Listening to the same music in multiple rooms</b>	<b>17</b>
Grouping rooms	17
Ungrouping rooms	18
Grouping all rooms	19
Ungrouping all rooms	20
<b>Listening to Internet Radio</b>	<b>21</b>
<b>Playing music stored on your mobile</b>	<b>21</b>
<b>Playing back files stored on a PC or NAS</b>	<b>21</b>
<b>Playing music from the AUX input</b>	<b>22</b>
<b>Playing music from a USB flash drive</b>	<b>22</b>
<b>Playing music from Bluetooth device</b>	<b>23</b>



<b>AirPlay function</b>	<b>24</b>
Playing songs from your iPhone, iPod touch, iPad or Mac	25
Playing songs from Windows PC	25
Play a song from your iPhone, iPod touch, iPad or Mac on multiple synced devices (AirPlay 2)	26
<b>Spotify Connect function</b>	<b>27</b>
Playing Spotify music with your speaker	27
<b>Quick Select function</b>	<b>28</b>
<b>Stereo pairing</b>	<b>29</b>

## Troubleshooting

<b>Troubleshooting</b>	<b>32</b>
Cannot connect the speaker to the network	33
Cannot pair a Bluetooth mobile device with the speaker	33
Cannot hear Bluetooth music	33
Music cuts out or delays sometimes	33
I hear a delay when using the AUX input with my TV	34
Connecting to a network using an iOS device	34
I hear distortion when using the AUX input	34
Connecting to a WPS network	35
Resetting your speaker	35
Buttons do not operate correctly	35
<b>Resetting the firmware to the default state</b>	<b>36</b>

## Status LED

<b>Status LED table</b>	<b>37</b>
-------------------------	-----------

## Appendix

<b>Power management</b>	<b>41</b>
<b>Enable/disable Wi-Fi and Bluetooth functions</b>	<b>42</b>
<b>Supported file types and codecs</b>	<b>43</b>
<b>Trademark information</b>	<b>44</b>
<b>Specifications</b>	<b>45</b>



Thank you for purchasing this Denon product.

To ensure proper operation, please read this owner's manual carefully before using the product.

After reading this manual, be sure to keep it for future reference.

## Accessories

Check that the following parts are included with the product.



Quick Start Guide



Safety Instructions



Warranty  
(North America model only)



Power cord  
(for Europe model)

or



Power cord  
(for North America model)



## Part names and functions

### Front panel

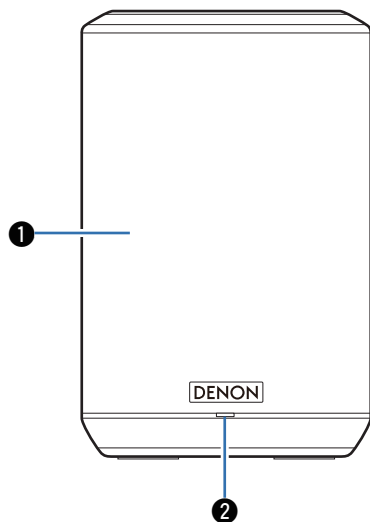

❶ **Speakers**

❷ **Status LED**

Please refer to the “Status LED table” for LED color and state meaning. (📖 p. 37)



## Top panel

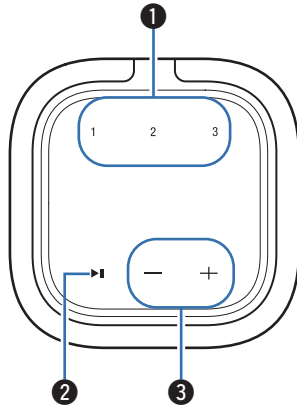

### 1 Quick select buttons (1 - 3)

Register input source settings to these buttons or recall those settings. (👉 p. 28)

### 2 Play/Pause button (▶||)

- Press this button to pause during playback. If pressed while paused or stopped, resumes playback from the last track played.
- Press and hold the button for 5 seconds to enter Deep Standby mode. (👉 p. 41)
- Double-tap this button during playback to play the next track.
- Triple-tap this button during playback to restart the current track or play the previous track.

### 3 Volume buttons (+, -)

These adjust the volume level.

#### NOTE

- Do not put anything on top of the speaker. Doing so may lead to accidental operations.



## Rear panel

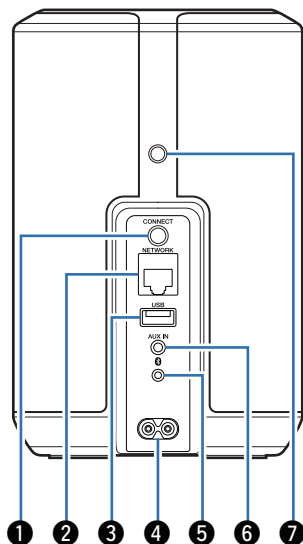

- 1 CONNECT button**  
Used for Wi-Fi setup. (👉 p. 13)
- 2 NETWORK connector**  
Used to connect this unit to a wired Ethernet network. (👉 p. 12)
- 3 USB port**  
Used to connect USB storage devices. (such as USB flash drives) (👉 p. 22)
- 4 AC inlet**  
Used to connect the power cord. (👉 p. 9)
- 5 Bluetooth button (📶)**  
Used in the Bluetooth pairing settings. (👉 p. 23)
- 6 AUX input connector (AUX IN)**  
Used to connect audio devices. (👉 p. 22)
- 7 Mounting screw hole**  
Used when mounting this unit to the wall or ceiling. (👉 p. 8)



## Placing

You can place your speaker anywhere you want to enjoy great sounding music. Please follow these simple guidelines when determining where to place your speaker...

- The speaker must be within range of your wireless network.
- The speaker is designed to sound best when placed 3 to 12 inches (8 - 30 cm) from a wall.
- Locate the speaker at least 12 inches (30 cm) from a television, computer, or other display device to avoid the possibility of interference.
- Place the speaker across the room from where you will be listening, as close to ear level as possible.
- The speaker is not waterproof. Do not place it near any water source and do not leave it outside in the rain or snow.

### Wall or ceiling mounting

This speaker can be mounted on a wall or ceiling using a standard speaker or camera mount/attachment (1/4 inches / 6.35 mm diameter) that supports at least 14 lbs 16 oz / 6.8 kg. For more information, contact the store you purchased the speaker.

#### Caution

- Use a commercial bracket (sold separately) to attach this unit to the wall or ceiling. Do not attach it directly to the wall or ceiling.
- If attaching this unit to the wall or ceiling, check that it is attached securely. Please be aware that Denon accepts no responsibility for any damage if the unit falls.





## Powering your speaker

Connect the power cord included in the box to the rear panel of the speaker and the plug to a wall outlet. The speaker is capable of automatically switching between 100 - 240 V.

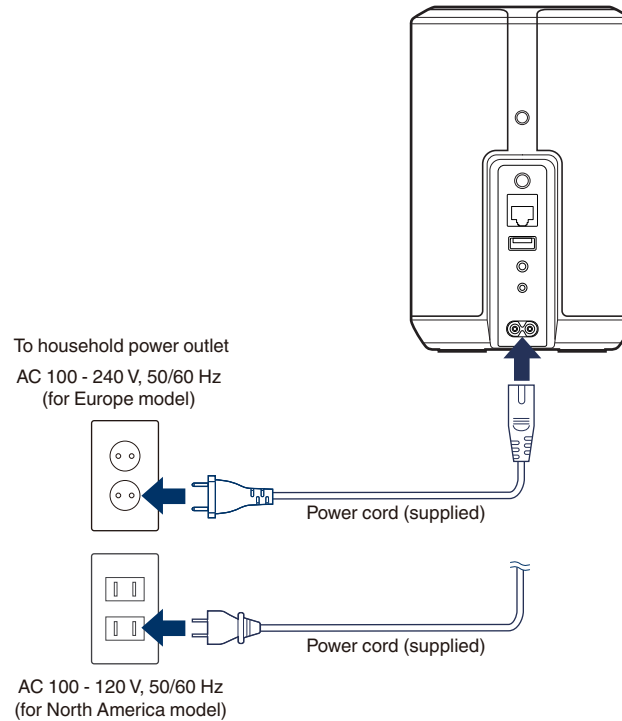

## Getting the HEOS app

---

You can use many online music streaming services from the HEOS app. Depending upon your geographical location, there are several options to choose from.

Download the HEOS app for iOS or Android by searching App Store®, Google Play™ store or Amazon App Store for “HEOS”.



For the purpose of improvement, the specifications and design are subject to change without notice.



## Setting up the HEOS app for the first time with a HEOS built-in device

Once you have placed your speaker in your listening room and have downloaded the HEOS app, you are ready to configure your speaker for music playback. This involves following a few simple steps to get the speaker connected to your existing home network:



- Do not connect the Ethernet cable if you are connecting your speaker to a wireless network. If you are connecting the speaker to a wired network, use an Ethernet cable sold separately to connect the speaker to your network or router.

### 1 Make sure your mobile device is connected to your wireless network (the same network you want your speakers connected to).

You can check this in the “Settings” - “Wi-Fi” menu of your iOS or Android device.



- Activate the Bluetooth setting on your mobile device.
- If your wireless network is secure, make sure you know the password to join your network.

### 2 Launch the HEOS app on your mobile device.

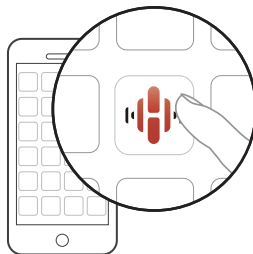

### 3 Tap the “Setup Now” button at the top of the screen.

### 4 Follow the instructions to add the speaker to your wireless network.



- If you have any problems connecting your speaker, jump to the Troubleshooting section ( p. 32).



## Adding the registration of HEOS built-in devices in the HEOS app

The HEOS system is a true multiroom audio system that automatically synchronizes audio playback between multiple HEOS built-in devices so that the audio coming from different rooms is perfectly in sync and always sounds amazing! You can easily add up to 32 HEOS built-in devices to your HEOS system.

### Adding wired HEOS built-in devices

Just connect the HEOS built-in devices to your home network using an Ethernet cable and the HEOS built-in device will appear on your HEOS app as a new room in the Rooms screen.

At your convenience, you can assign a name to the HEOS built-in device to indicate which room you have it placed in.



- Use only a shielded STP or ScTP LAN cable which is easily available at electronics stores (CAT-5 or greater recommended).
- The normal shielded-type LAN cable is recommended. If a flat-type cable or unshielded-type cable is used, other devices could be affected by noise.
- Do not connect a NETWORK connector directly to the LAN port/Ethernet connector on your computer.



## Adding wireless HEOS built-in devices

You can add additional wireless HEOS built-in devices to your HEOS system by selecting “Add Device” from the HEOS app’s settings menu and follow the instructions:

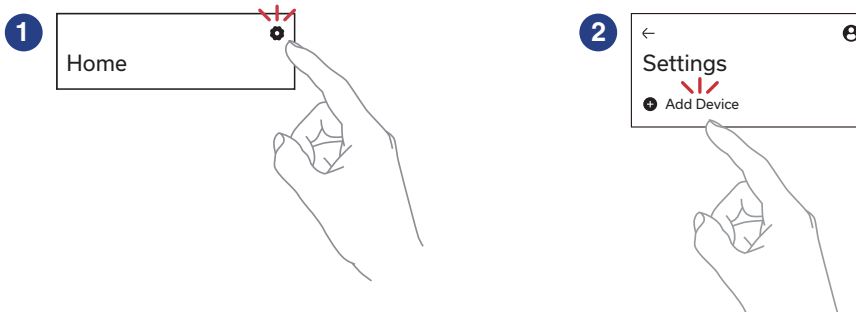

## HEOS account

---

### ■ What is a HEOS account?

A HEOS account is master account or “keychain” for managing all of your music services with one single username and password.



### ■ Why do I need a HEOS account?

With the HEOS account you just have to enter your music services login names and passwords one time. This allows you to easily and quickly use multiple controller apps on different devices. You just log into your HEOS account on any device and you will have access to all of your associated music services, play history and custom playlists, even if you are at a friend’s house listening to music on their HEOS system.

### ■ Signing up for a HEOS account

You will be instructed to signup for a HEOS account the first time you try to access any music service from the “Home” screen of the HEOS app.

### ■ Changing your HEOS account

- 1 Tap the “Home” tab.
- 2 Select the Settings  icon in the upper-right corner of the screen.
- 3 Select the HEOS Account  icon.
- 4 Change your location, change your password, delete your account or sign out of your account.



## Playing from streaming music services

A music service is an online music company that provides access to vast music collections via free and/or paid subscriptions. Depending upon your geographical location, there are several options to choose from.

### NOTE

- The HEOS app and brand is not affiliated with any manufacturer of any mobile device. Availability of music services may vary by region. Not all services may be available at time of purchase. Some services may be added or discontinued from time to time based on decisions of the music service providers or others.

## Selecting a room/device

- 1 Tap the “Rooms” tab. Select “Denon Home 150 NV” if there are multiple HEOS built-in devices.



- Tap “Edit” at the top right to switch edit mode. You can change the displayed name.

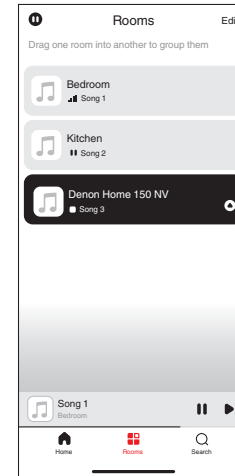

## Selecting the music track or station from music sources

### 1 Tap the “Home” tab and select a music source.

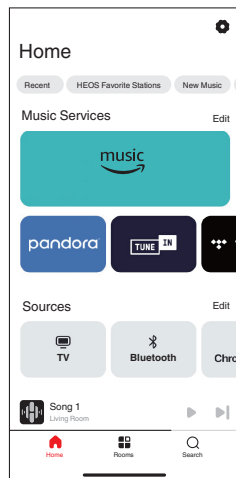

- All music services displayed may not be available in your location.

### 2 Browse the music to play.

After selecting a music track or radio station the app will automatically change to the “Now Playing” screen.

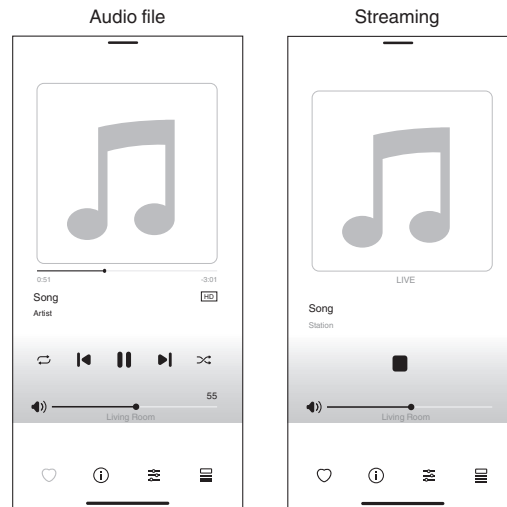

- The “Now Playing” banner appears on the “Home” screen, “Rooms” screen and “Search” screen. You can check the song currently playing and perform simple playback operations no matter which screen is displayed.





## Listening to the same music in multiple rooms

This system is a true multi-room audio system. You can create one or more HEOS groups to automatically synchronize audio playback between multiple products with HEOS built-in so that the music playing different rooms is perfectly in sync and always sounds amazing! You can easily add up to 32 products to your system in total. You can group up to 16 individual products to have them play the same song fully synchronized.

### Grouping rooms

- 1 Press and hold your finger on room that is not playing music.**
- 2 Drag it into the room that is playing music and lift your finger.**
- 3 The two rooms will be grouped together into a single device group and both rooms will be playing the same music in perfect sync.**

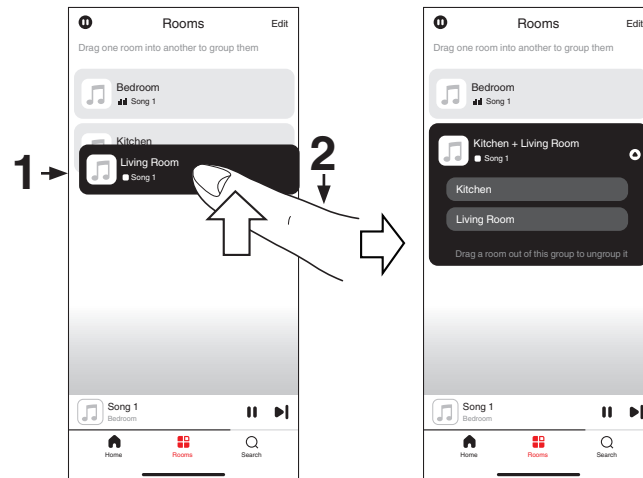

## Ungrouping rooms

- 1 Press and hold your finger on room that you want to remove from the group.
- 2 Drag it out of the group and lift your finger.

### NOTE

- You can not remove the first room that started playing the music before grouping.

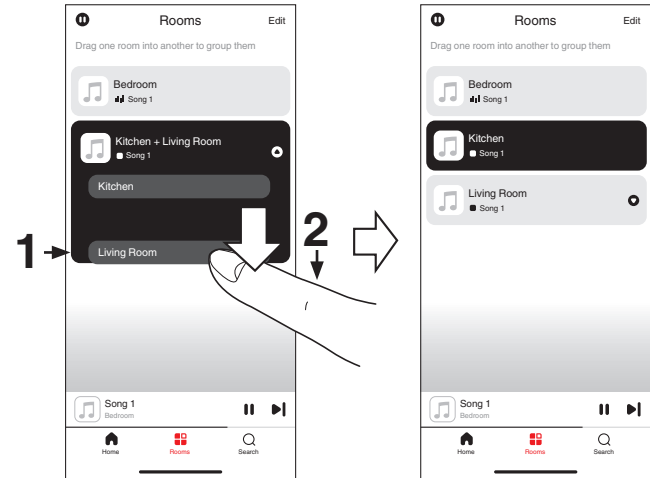

## Grouping all rooms

You can easily group all rooms (up to 16 rooms) together by using a “pinch” gesture.

- 1** Place two fingers on the screen over the list of rooms.
- 2** Quickly pinch your two fingers together and release.
- 3** All of your rooms will be joined together and begin playing the same music in perfect sync.

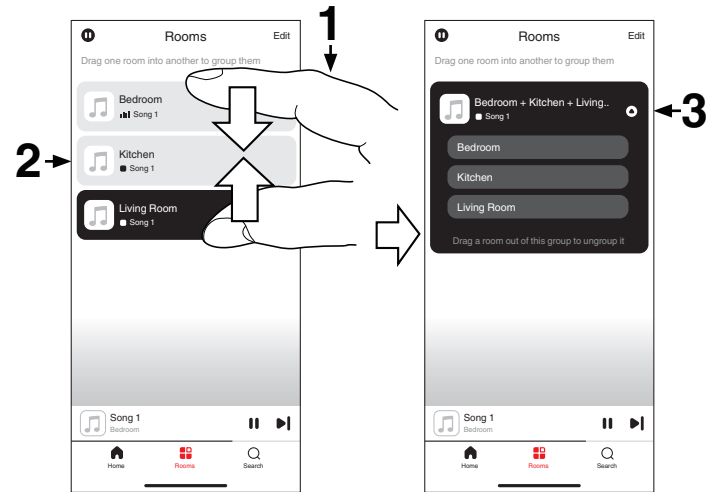

## Ungrouping all rooms

You can easily ungroup all of your rooms by using a “spread” gesture.

- 1** Place two fingers close together on the screen over list of rooms.
- 2** Quickly spread your two fingers apart from each other and release.
- 3** All of your rooms will be ungrouped.

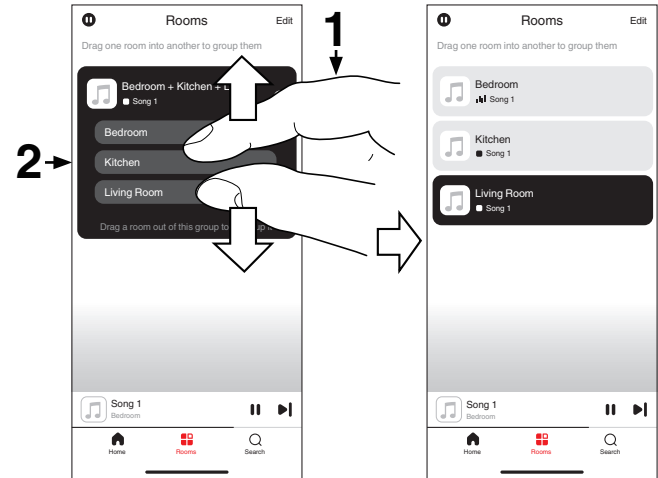

## Listening to Internet Radio

---

The HEOS system includes access to more than 100,000 free internet radio streams from all corners of the globe via the TuneIn radio service. Just select the TuneIn logo from the “Home” screen and browse among the 100,000 stations neatly organized into popular categories and select a station that appeals to your mood.



- If you have a TuneIn account, tap “Edit” from the “Music Services” section of the “Home” screen, select “TuneIn” and sign in to the TuneIn service to access all “My Favorites” TuneIn stations.

### NOTE

- The radio station database service may be suspended or be otherwise unavailable without notice.

## Playing music stored on your mobile

---

- 1 Tap the “Home” tab.
- 2 Select “This Phone” from the “Sources” section.
- 3 Browse the local music on your phone and select something to play.

## Playing back files stored on a PC or NAS

---

- 1 Tap the “Home” tab.
- 2 Select “Server” from the “Sources” section.
- 3 Select the name of your networked PC or NAS (Network Attached Storage) server.
- 4 Browse the music on your PC/NAS and select something to play.



## Playing music from the AUX input

---

### 1 Connect an audio device with a 3.5 mm stereo audio output to the AUX input on your speaker using a 3.5 mm stereo audio cable sold separately.

When a 3.5 mm stereo audio cable is connected to “AUX IN”, the source automatically switches to Inputs.



- If a cable is connected to the AUX IN connector, select “Inputs” from the “Sources” section of the “Home” screen.

### 2 Initiate playback on the audio device.



- The sound from the audio device can be played directly on the selected speaker or digitized and sent over your network to other speakers.

#### NOTE

- The analog output signals from some sources can be fairly strong. If the input level of the source device is turned up high, it could overload the inputs of the speaker. This is unlikely to cause damage, but can cause distorted sound. Initially, set the volume of the source to a medium – low level, then turn it up as needed. If you hear distortion, turn down the device's volume control.

## Playing music from a USB flash drive

---

- 1 Insert a FAT32 or NTFS formatted USB flash drive into the USB port on the rear panel of the speaker.
- 2 Tap the “Home” tab.
- 3 Select “USB” from the “Sources” section.
- 4 Select the name of your speaker.
- 5 Browse the music on your USB flash drive and select something to play.

#### NOTE

- It may take several minutes for the name of your speaker to appear in the “USB” list if you have a large number of files on your USB flash drive.
- It is not possible to connect and use a computer via the USB port of this unit using a USB cable.



## Playing music from Bluetooth device

- 1** Activate the Bluetooth setting on your mobile device.
- 2** Press and hold the Bluetooth button (📶) located on the rear panel of the speaker for 3 seconds and release the button when you see a pattern of two green flashes on the status LED.

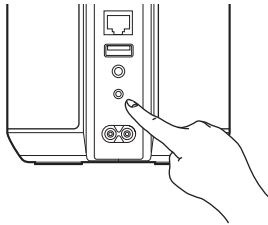

- 3** Select “Denon Home 150 NV” from the list of available Bluetooth devices.

In a few seconds your mobile device will indicate that it is connected to your speaker.

- 4** Play music using any app on your device.

The sound will now play from the speaker.

### NOTE

- If no sound is heard, disconnect and reconnect Bluetooth connections from your Bluetooth device.



## AirPlay function

---

Music files stored on your iPhone, iPod touch, iPad, Mac or Windows PC can be played on this unit via the network.



- Input source will be switched to “AirPlay” when AirPlay playback is started.
- You can stop AirPlay playback by choosing other input source.
- The screen may differ depending on the OS and software versions.

**This device supports AirPlay 2®.**

Sync multiple AirPlay 2 compatible devices/speakers for simultaneous playback.





## Playing songs from your iPhone, iPod touch, iPad or Mac

You can stream music stored in your “iPhone/iPod touch/iPad/Mac” directly to this unit.

- 1 Connect your iPhone, iPod touch, iPad or Mac Wi-Fi to the same network as this unit.**
  - For details, see your device’s manual.
- 2 Open Apple Music and play music from your iPhone, iPod touch or iPad.**
- 3 Tap or click the AirPlay icon and select this unit.**

[Example] iOS 15 or macOS 13

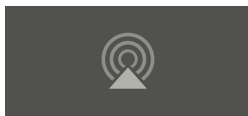

[Example] iOS 10



- You can also use AirPlay to stream music from other applications. Open the Control Center, tap or click the AirPlay icon, then select this unit.
- To use AirPlay, your iOS device must support iOS 10.0.2 or later, or OS X Mountain Lion 10.8 or later.

## Playing songs from Windows PC

- 1 Install iTunes 10, or later, on a Windows PC that is connected to the same network as this unit.**
- 2 Start iTunes and click the AirPlay icon to select this unit.**

[Example] iTunes



- 3 Choose a song and click play in iTunes.**  
The music will stream to this unit.



- For information about how to use iTunes, also see the Help for iTunes.



## Play a song from your iPhone, iPod touch, iPad or Mac on multiple synced devices (AirPlay 2)

Songs from an iPhone, iPod touch, iPad or Mac can be synced with multiple AirPlay 2 supported devices for simultaneous playback.

### 1 Play the song on your iPhone, iPod touch, iPad or Mac.

AirPlay icon is displayed on the iPhone, iPod touch, iPad or Mac screen.

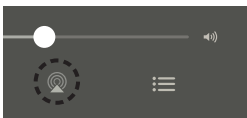

### 2 Tap or click the AirPlay icon and select this unit.

Displays a list of devices/speakers that can be played back on the same network.

- A circle is displayed to the right of AirPlay 2 compatible devices.

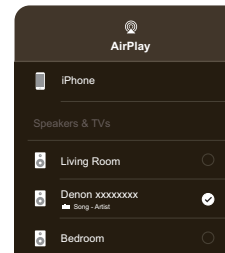

### 3 Select the devices/speakers you want to use.

- Multiple AirPlay 2 compatible devices can be selected.

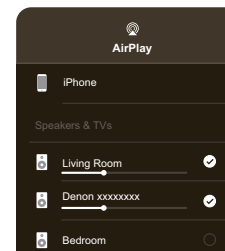

- To use AirPlay 2, your iOS device must support iOS 11.4 or later, or macOS Catalina or later.



## Spotify Connect function

Spotify is all the music you'll ever need. Millions of songs available instantly. Just search for the music you love, or let Spotify play you something great. Spotify works on your phone, tablet, computer and home speakers. So you'll always have the perfect soundtrack for whatever you're doing. Now you can enjoy Spotify with your free account as well as Premium account.

Use your phone, tablet or computer as a remote control for Spotify. Go to [www.spotify.com/connect](http://www.spotify.com/connect) to learn how.

The Spotify software is subject to third party licenses found here: [www.spotify.com/connect/third-party-licenses](http://www.spotify.com/connect/third-party-licenses)

### Playing Spotify music with your speaker

Download the "Spotify App" onto your iOS or Android device beforehand.

- 1 Connect the Wi-Fi settings of the iOS or Android device in the same network as this unit.**
- 2 Launch the Spotify App.**
- 3 Play back the Spotify track.**
- 4 Tap the Spotify icon  to select the unit.**  
The music will stream to this unit.



## Quick Select function

---

Input source settings can be registered to the Quick select buttons (1 - 3).

- 1 To register the current settings, press and hold down one of the Quick Select buttons (1 - 3) on the top panel for 3 seconds.**



- The status LED blinks once when registration is complete.
- To recall the registered settings, press the Quick Select button on the top panel.

### [Default settings]

Button	Input source
Quick Select 1	AUX In
Quick Select 2	—
Quick Select 3	—





# Stereo pairing

## ■ Creating a stereo pair

A matching pair of speakers that have been grouped together can be saved as a persistent stereo pair where one speaker outputs the left channel of audio and the other speaker outputs the right channel of audio. Paired speakers will then appear as a single room (with two speakers playing music) in the Rooms list.

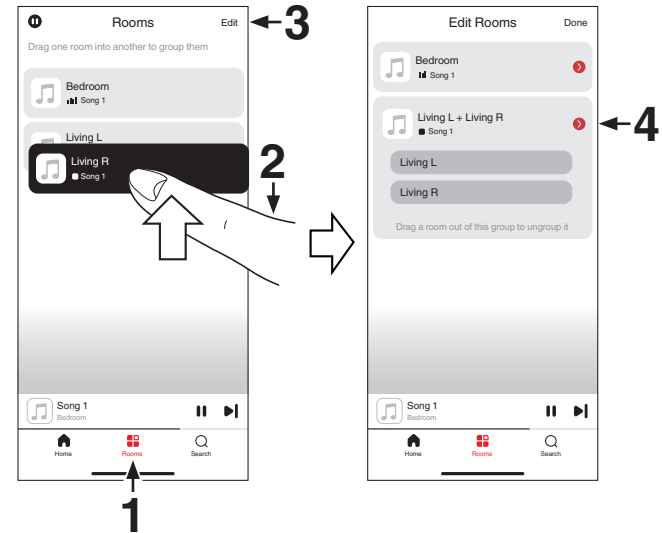
- 1 Tap the “Rooms” tab.
- 2 Create a group containing only two matching speakers (see “Grouping rooms” (p. 17)).
- 3 Tap “Edit” to enter edit mode.
- 4 Tap on the Group of two matching speakers to Edit the Group.



- 5 Tap on the “Stereo Pair” switch to pair the two speakers.
- 6 Tap the Back arrow  to return to the list of Rooms.
- 7 Tap “Done” to exit edit mode.

The group of two matching speakers will now appear as a single room. You can change the name of the stereo paired room at any time.

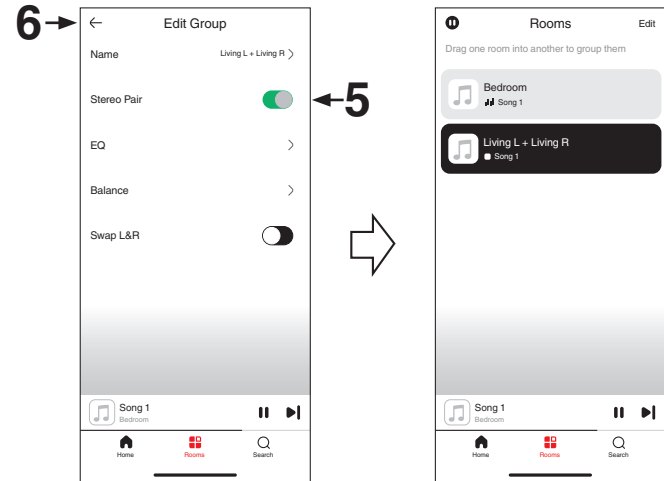

## ■ Removing a stereo pair

- 1 Tap the “Rooms” tab.
- 2 Tap “Edit” to enter edit mode.
- 3 Tap a room which contains two matching speakers to edit the group.
- 4 Tap on the “Stereo Pair” switch to return the paired speakers to two individual speakers.
- 5 Tap the Back arrow  to return to the list of Rooms.
- 6 Tap “Done” to exit edit mode.



# Troubleshooting

---

If a problem should arise, first check the following:

1. **Are the connections correct?**
2. **Is the set being operated as described in the owner's manual?**
3. **Are the other devices operating properly?**



- If steps 1 to 3 above do not improve the problem, restarting the device may improve the problem. Remove and re-insert the power cord of the unit.

If this unit does not operate properly, check the corresponding symptoms in this section.

If the symptoms do not match any of those described here, consult your dealer as it could be due to a fault in this unit. In this case, disconnect the power immediately and contact the store where you purchased this unit.





## Cannot connect the speaker to the network

- Make sure your mobile device is connected to your wireless network before setting up your speaker. (👉 p. 11)
- Alternatively, you can connect your speaker to your network router using an Ethernet cable sold separately. Once connected via Ethernet, the HEOS app should recognize the speaker and you can manually move it to your wireless network using “Settings” - “My Devices” - (“Device Name”) - “Advanced” - “NETWORK SETTINGS”. (👉 p. 12)

## Cannot pair a Bluetooth mobile device with the speaker

- The connection from the Bluetooth mobile device is malfunctioning. Power cycle the mobile device, remove the pairing information and re-pair the speaker to the mobile device.

## Cannot hear Bluetooth music

- Your Bluetooth mobile device is not paired with speaker. Re-pair the speaker to the mobile device.
- The speaker is Wi-Fi mode or Aux-in mode etc. Pair and connect Bluetooth device to speaker.
- The Bluetooth mobile device is connected to another audio device. Make sure your Bluetooth device is connected to speaker.
- The volume on Bluetooth mobile device is too low. Check the volume on the Bluetooth mobile device. Check the volume on the speaker.

## Music cuts out or delays sometimes

- Make sure your Internet connection is operating correctly. If you are sharing your network with other users or devices, they may be using most of your bandwidth (especially if they are streaming video).
- Make sure your speakers are within range of your wireless network.
- Make sure your speakers are not located near other electronic devices that could interfere with its wireless connectivity (like microwave ovens, cordless phones, TVs, etc...).



## I hear a delay when using the AUX input with my TV

- If you are connecting the AUX input with your cable or satellite box for enjoying TV audio through multiple speakers, you may hear a delay between when you see someone speak and when you hear the audio. This is because the HEOS system must buffer the audio before it sends it out to the speakers so that it arrives at all speakers at the same time. (🔗 p. 22)
- You can avoid this delay by listening only to the speaker which is directly connected to the set top box.

## Connecting to a network using an iOS device

- This speaker supports Apple's "WAC (Wireless Accessory Configuration)" setup mode. WAC setup mode allows you to connect your speaker to your network without requiring you to type in the network name and password. The iOS device firmware version needs to support iOS 10.0.2 or later.
  1. Press and hold - and ►|| buttons for 3 seconds.
  2. Go to the Wi-Fi menu under Settings on your iOS device.
  3. Select "Denon Home 150 NV" under "SET UP NEW AIRPLAY SPEAKER..." at the bottom of the list.
  4. Select the network you want your speaker to connect to and select "Next".
  5. Follow the instructions on the screen to complete setup.

HEOS system will stay in WAC setup mode for 15 minutes. If the device is not setup within 15 minutes, it will revert back to its previous network connection. Press the ►|| button if you want to cancel WAC setup mode.

The status LED will quickly blink 5 times.

## I hear distortion when using the AUX input

- The analog output signals from some sources can be fairly strong. If the input level of the source device is turned up high, it could overload the inputs of the speaker. This is unlikely to cause damage, but can cause distorted sound. Initially, set the volume of the source to a medium – low level, then turn it up as needed. If you hear distortion, turn down the device's volume control.



## Connecting to a WPS network

- If your wireless router support WPS (Wi-Fi Protected Setup™) your speaker can optionally connect to your network using the “Push Button” method by following these steps:  
Wi-Fi Protected Setup™ is trademarks of Wi-Fi Alliance.
  1. Press the WPS button on your router.
  2. Within 2 minutes, press and hold the CONNECT button on the rear panel of the speaker for 5 seconds.
  3. The LED on the front of the speaker will flash green for several seconds as it connects to your WPS router.
  4. When the connection is complete, the LED on the front of the speaker will turn solid blue.

## Resetting your speaker

- Resetting your speaker will clear out the wireless network info, EQ, and name but retain it's current software. You will have to use “Settings” - “Add Device” to reconnect the speaker to your home network before it can be used.  
To reset your speaker, press and hold the CONNECT and Bluetooth (📶) buttons located on the rear panel of the speaker for 5 seconds until the front LED begins to flash amber.

## Buttons do not operate correctly

- Do not put anything on top of the speaker.
- Items near the top of the speaker (curtains, steel racks, etc.) may cause unintended button activation.
- Set up the speaker where there is nothing nearby.
- Unplug the power cord before cleaning the top panel.



## Resetting the firmware to the default state

When the network function or this unit do not operate correctly, the problem may be solved by resetting the firmware to the default state.

- It is confirmed that the network connection has no problem, but the unit cannot connect to the Internet.
- The solution described in “Resetting your speaker” does not work. (👉 p. 35)

For such cases, perform the following operation:

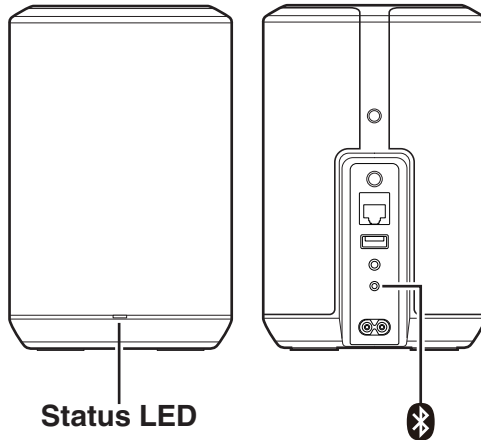

- 1 Unplug the power cord from the power outlet.**
- 2 Plug in the power cord while holding down the Bluetooth(📶) button.**
- 3 Release the button after the status LED starts to blink in orange.**

When the status LED switches from blinking orange to solid, the recovery process is complete.







- Since this process includes a firmware recovery, it takes some time to complete.
- This process will clear out all the information that you set.
- After performing this RESET to default state, an update to actual firmware version is needed.
- Do not unplug the power cord until the entire process completes.
- If the problem is not solved after performing this operation, contact our customer service center.





## Status LED table





The LEDs on the front panel change to indicate the current speaker status.

Speaker status	LED action	Description
Deep Standby mode	 (off)	Power is off, or the speaker is in Deep Standby mode. (👉 p. 41)
Quick Start mode	 (dimmed solid)	Speaker is in Quick Start mode. (👉 p. 41)
Power on	 (blink)	Speaker is starting up or connecting to the network.
	 (solid)	Speaker is connected to the network.
	 (solid)	Speaker is unable to connect to the network. Try to connect the speaker again.







Speaker status	LED action	Description
WPS	 (fast blink)	Speaker is connecting to the network via WPS.
	 (for 3 sec. solid)	Speaker is connected to the network via WPS.
	 (for 3 sec. solid)	WPS has timed out.



Speaker status	LED action	Description
Bluetooth	 (two blinks)	Speaker is pairing via Bluetooth.
	 (one blink)	Speaker is paired via Bluetooth.
	 (for 3 sec. solid)	Speaker failed to pair to the Bluetooth device. Try to pair again. (🔗 p. 23)
Volume setting	 (quick blink)	Volume is being adjusted.
	 (slow blink)	Speaker is muted.



Speaker status	LED action	Description
Firmware update	 (blink)	Firmware is being updated.
	 (slow blink (Not fade))	There is a firmware error. Check your usage environment, relaunch the app, then try to update the firmware again.
Error	 (solid)	There was a setup error. Check your usage environment, then follow the correct procedure to try setup again. If the error occurs again, restore factory settings and try setup again. (📖 p. 35)
	 (fast blink)	There is a hardware error. Unplug the power cord, wait a little while, then plug the power cord back in.
Reset	 (blink)	Factory settings have been restored.





# Power management

## ■ Quick Start Mode

This speaker automatically enters “Quick Start Mode” to save power in the following cases. During “Quick Start Mode”, speaker operations cause the power to turn on.

During “Quick Start Mode”, the status LED lights in dim blue.

### ❑ Ethernet

After around 20 minutes of no operation and no network access after playing music via Ethernet.

### ❑ Wi-Fi

After around 20 minutes of no operation and no network access after playing music via Wi-Fi.

### ❑ USB

After around 20 minutes of no operation and no network access after playing music from a USB flash drive.

### ❑ Bluetooth

After the Bluetooth connection is disconnected and there is around 20 minutes of no operation and no network access after playing music via Bluetooth.

### ❑ AUX IN

After around 20 minutes of no audio.

## ■ Deep Standby

The device also has the ability to automatically enter “Deep Standby” whenever the wired or wireless network connection is removed for more than 60 minutes in “Quick Start Mode”. The front panel LED will turn off during Deep Standby.

Press any button to turn the power on.



- You also press the ►|| button for 5 seconds, the device enters the Deep Standby.

## ■ Off

To completely turn off the power to the device you must remove the mains plug from the power outlet.



## Enable/disable Wi-Fi and Bluetooth functions

By disabling Wi-Fi and Bluetooth functions, you can reduce power consumption in Quick Start Mode. Select “Network” from the settings menu in the HEOS app to set it up. Follow these steps to set it up:

- 1 Tap the “Home” tab.
- 2 Select the Settings  icon in the upper-right corner of the screen.
- 3 Select “My Devices”.
- 4 Select “Denon Home 150 NV”.
- 5 Select “Network”.

### ■ Wi-Fi

---

**On**  
(Default): Wi-Fi function enabled.

---

**Off:** Wi-Fi function disabled.

---



- When setting Wi-Fi to “Off”, use an Ethernet cable to establish the network connection.

### ■ Bluetooth

---

**On**  
(Default): Bluetooth function enabled.

---

**Off:** Bluetooth function disabled.

---



## Supported file types and codecs

Sampling frequency	Bit length	File Extension	Codec	Bit Rates
32/44.1/48 88.2/96/176.4 192 kHz	16/24 bit	wav	PCM	---
32 kHz 44.1 kHz 48 kHz	16 bit	mp3	MPEG-1 Audio Layer 3 CBR/VBR	32 - 320 kbps
32 kHz 44.1 kHz 48 kHz	16 bit	m4a aac	AAC-LC	48 - 320 kbps
32 kHz 44.1 kHz 48 kHz	16 bit	wma	wma9 CBR	CBR:48 - 192 kbps
44.1/48 88.2/96/176.4 192 kHz	16/24 bit	flac	flac	---
44.1/48 88.2/96/176.4 192 kHz	16/24 bit	m4a	ALAC	---
2.8/5.6 MHz	1 bit	dff dsf	DSDIFF DSF	---

### NOTE

- Files protected by DRM such as Apple's Fairplay DRM, are not supported.
- If you select a music source with a high bit rate or high resolution, it is set to the appropriate level by codec before being output.
- The ALAC decoder is distributed under the Apache License, Version 2.0 (<http://www.apache.org/licenses/LICENSE-2.0>)



## Trademark information



Google Play and the Google Play logo are trademarks of Google LLC.



App Store® is registered in the U.S. and other countries.



The Wi-Fi CERTIFIED logo is a registered trademark of the Wi-Fi Alliance.  
Wi-Fi Certification provides assurance that the device has passed the interoperability test conducted by the Wi-Fi Alliance, a group that certifies interoperability among wireless LAN devices.



The Bluetooth® word mark and logos are registered trademarks owned by the Bluetooth SIG, Inc. and any use of such marks by DEI Sales, Inc. is under license. Other trademarks and trade names are those of their respective owners.



Apple, AirPlay, iPad, iPad Air, iPad Pro, iPhone and Mac are trademarks of Apple Inc., registered in the U.S. and other countries.  
The trademark "iPhone" is used in Japan with a license from Aiphone K.K.

Use of the Works with Apple badge means that an accessory has been designed to work specifically with the technology identified in the badge and has been certified by the developer to meet Apple performance standards.



# Specifications

---

## Wireless LAN

<b>Network type:</b>	Conforming to IEEE 802.11a/b/g/n/ac
<b>Used frequency range:</b>	2.4 GHz, 5 GHz

## Bluetooth section

<b>Communications system:</b>	Bluetooth Version 5.4
<b>Transmission power:</b>	Power Class 1
<b>Maximum communication range:</b>	Approx. 98.4 ft/30 m in line of sight *
<b>Used frequency range:</b>	2.4 GHz band
<b>Modulation scheme:</b>	FHSS (Frequency-Hopping Spread Spectrum)
<b>Supported profiles:</b>	A2DP, AVRCP
<b>Corresponding codec:</b>	SBC
<b>Transmission range (A2DP):</b>	20 Hz – 20,000 Hz

\* The actual communication range varies depending on the influence of such factors as obstructions between devices, electromagnetic waves from microwave ovens, static electricity, cordless phones, reception sensitivity, antenna performance, operating system, application software etc.



## General

**Operating temperature:**

41 °F - 95 °F (5 °C - 35 °C)

**Power supply:**

AC 100 – 240 V, 50/60 Hz (for Europe model)

AC 100 – 120 V, 50/60 Hz (for North America model)

**Power consumption:**

20 W

**Power consumption in Quick Start Mode:**

Connection	Setting items in the HEOS app		Power consumption
	Wi-Fi (🔌 p. 42)	Bluetooth (🔌 p. 42)	
Wi-Fi 2.4 GHz	On	Off	2.0 W
Wi-Fi 5 GHz	On	Off	2.0 W
Ethernet	Off	Off	1.7 W
USB with Ethernet	Off	Off	1.8 W
Bluetooth	Off	On	1.5 W
All with Ethernet	On	On	2.4 W

**Power consumption in Deep Standby Mode:**

0.4 W

**Max Analog Input:**

2 Vrms



## Dimensions

Unit : in. (mm)

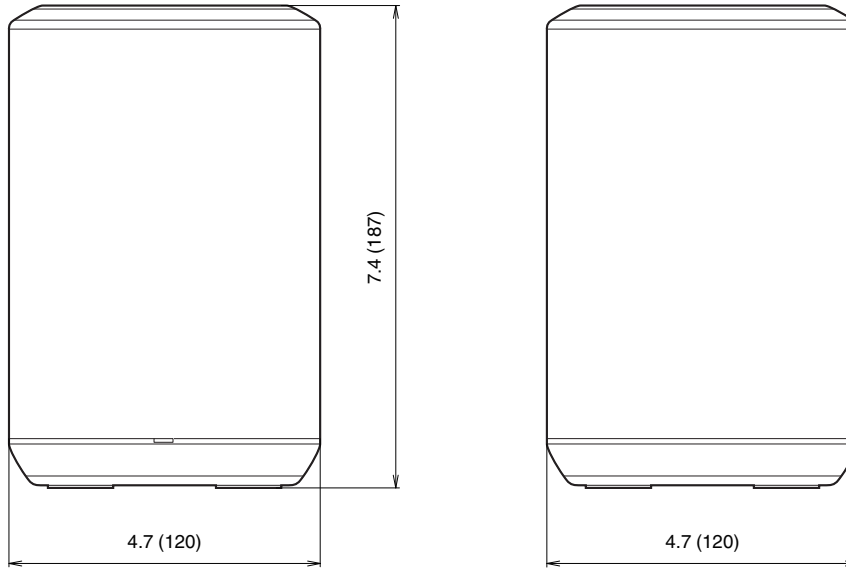

**Weight : 3 lbs 12 oz (1.7 kg)**

For the purpose of improvement, the specifications and design are subject to change without notice.



DENON®

[www.denon.com](http://www.denon.com)

3520 10965 00AS

©2024 Masimo. All Rights Reserved.