

SAMSUNG

Product Guide

7100 Series Laundry

WA55CG7100 – Washer

WA54CG7105 – Agitator Washer

DVE55CG7100 – Electric Dryer

DVG55CG7100 – Gas Dryer

Available in Brushed Black or White



Table of Contents

WA55CG7100 - Top Load Washer

Product Overview

Product Overview	4
Carousel Image Order	5

Product Messaging

Features and Benefits	8
Lifestyle Images	14

Product Specs

Related Products and Accessories	17
Spec Sheet	18
Energy Guide	19
User Manual and Warranty	20

Feature Icons	22
---------------	----

WA54CG7105 - Top Load Washer

Product Overview

Product Overview	24
Carousel Image Order	25

Product Messaging

Features and Benefits	28
-----------------------	----

Product Specs

Related Products and Accessories	34
Spec Sheets	35
Energy Guide	36
User Manual and Warranty	37

Feature Icons	39
---------------	----

DVE55CG7100 - Electric Dryer

DVG55CG7100 - Gas Dryer

Product Overview

Product Overview	41
Carousel Image Order	42

Product Messaging

Features and Benefits	45
-----------------------	----

Product Specs

Related Products and Accessories	50
Spec Sheets	51
User Manual and Warranty	52

Feature Icons	54
---------------	----

Price Tag Guidance	55
--------------------	----

Product Overview

WA55CG7100AV
WA55CG7100AW

**5.5 cu. ft. Extra-Large Capacity Smart Top Load
Washer with Super Speed Wash**

Product Overview

Product Title

5.5 cu. ft. Extra-Large Capacity Smart Top Load Washer with Super Speed Wash

Product Description

Samsung's 5.5 cu. ft. Extra-Large Capacity Top Load Washing Machine is equipped with Super Speed Wash, which powerfully cleans a full load of laundry in just 28 minutes* without sacrificing cleaning performance. With Wi-Fi connectivity, you can remotely start, stop, or delay your smart washer from our simple-to-use SmartThings App.** Active WaterJet, a built-in water faucet, lets you easily pretreat heavily soiled and stained clothes.

- Super Speed Wash – Thoroughly wash a full load in just 28 minutes*
- Wi-Fi Connectivity with SmartThings – Remotely start, schedule, and receive end-of cycle alerts to your smartphone**
- Active WaterJet – Easily pretreat with a built-in water faucet

* Based on using Super Speed wash on a Normal Cycle with an 8lb load.

** Requires wireless network, Samsung account and SmartThings App. The Samsung SmartThings App supports Android OS 4.0 (ICS) or later which is optimized for Samsung smartphones (Galaxy S and Galaxy Note series). This app also supports iOS 7 or later for iPhone models. SmartThings App available in App Store and Play Store.

Easy Ads Links

Brushed Black Washer: <https://dam.gettyimages.com/p/z0c3461/digital-appliances?o=AND&q=WA55CG7100AV>

White Washer: <https://dam.gettyimages.com/p/z0c3461/digital-appliances?o=AND&q=WA55CG7100AW>

Available Colors



Brushed Black

Model Number: WA55CG7100AV

UPC: 887276739137



White

Model Number: WA55CG7100AW

UPC: 887276739144



Carousel Image Order

WA55CG7100AV



Carousel Image Order

WA55CG7100AW





Product Messaging

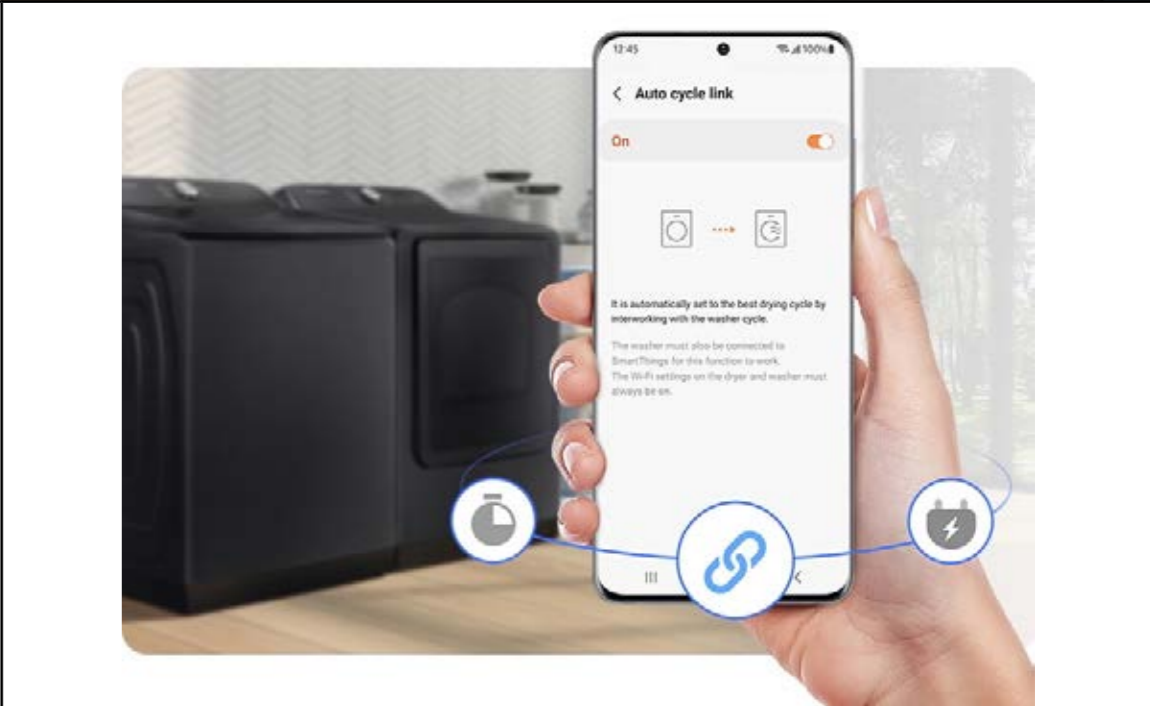

WA55CG7100AV
WA55CG7100AW

**5.5 cu. ft. Extra-Large Capacity Smart Top Load
Washer with Super Speed Wash**



Features and Benefits: WA55CG7100*

Headline	Feature Name	Long Body Copy	Short Body Copy	Associated Image
<p>Wash more items in a single load</p>	<p>Extra-Large 5.5 cu. ft. Capacity</p>	<p>Fewer loads, less time in the laundry room, and more time doing the things you love.</p>	<p>Fewer loads, less time in the laundry room.</p>	
<p>Connect with SmartThings</p>	<p>Wi-Fi Connectivity with SmartThings</p>	<p>Wi-Fi connected so you can receive end-of-cycle alerts, remotely start or stop your washing, schedule cycles on your time, and more, right from your smartphone with the SmartThings App.*</p> <p><small>*Requires wireless network, Samsung account and SmartThings App. The Samsung SmartThings App supports Android OS 4.0 (ICS) or later which is optimized for Samsung smartphones (Galaxy S and Galaxy Note series). This app also supports iOS 7 or later for iPhone models. SmartThings App available in App Store and Play Store.</small></p>	<p>With Wi-Fi connectivity, remotely start, stop, or delay your washer from one simple-to-use app. Get energy usage notifications and so much more.*</p> <p><small>*Requires wireless network, Samsung account and SmartThings App. The Samsung SmartThings App supports Android OS 4.0 (ICS) or later which is optimized for Samsung smartphones (Galaxy S and Galaxy Note series). This app also supports iOS 7 or later for iPhone models. SmartThings App available in App Store and Play Store.</small></p>	
<p>Wash a full load in just 28 minutes*</p> <p><small>*Based on using Super Speed wash on a Normal Cycle with an 8lb load.</small></p>	<p>Super Speed Wash</p>	<p>Wash a full load of laundry in just 28 minutes* without sacrificing cleaning performance.</p> <p><small>*Based on using Super Speed Wash on a Normal Cycle with an 8lb load.</small></p>	<p>Powerful cleaning in just 28 minutes.*</p> <p><small>*Based on using Super Speed Wash on a Normal Cycle with an 8lb load.</small></p>	

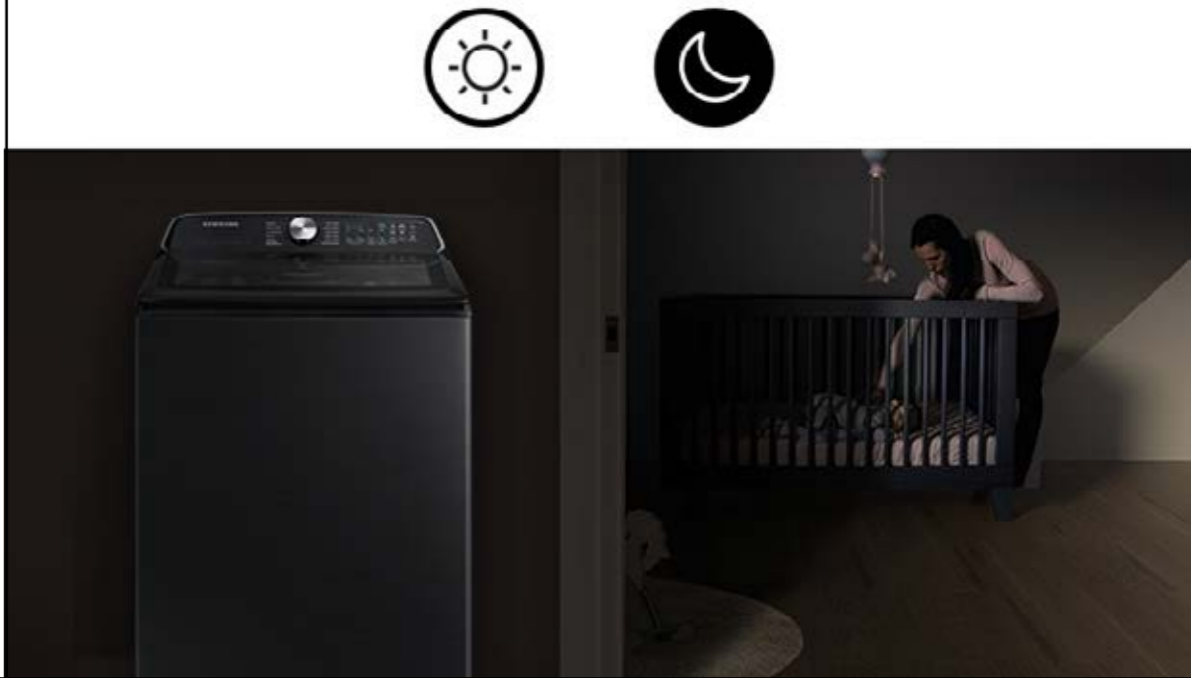

Features and Benefits: WA55CG7100* (Continued)

Headline	Feature Name	Long Body Copy	Short Body Copy	Associated Image
<p>Pretreat with the push of a button</p>	<p>Active WaterJet</p>	<p>A built-in water faucet lets you easily pretreat soiled or heavily stained clothes with the press of a button. Scrub items right inside your washer, no laundry room sink needed.</p>	<p>A built-in water faucet lets you easily pretreat heavily soiled and stained clothes.</p>	
<p>Purchase with confidence</p>	<p>20-Year Motor Warranty</p>	<p>Purchase with confidence any Samsung Washer model with a Digital Inverter Motor and receive a 20 year warranty on the motor.*</p> <p><small>*20-year warranty limited to the Digital Inverter Motor of washers purchased on 7/1/2022 or later. Purchase receipt indicating purchase date required for a claim. Additional restrictions and limitations apply, see warranty for details.</small></p>	<p>Purchase with confidence any Samsung Washer model with a Digital Inverter Motor and receive a 20 year warranty on the motor.*</p> <p><small>*20-year warranty limited to the Digital Inverter Motor of washers purchased on 7/1/2022 or later. Purchase receipt indicating purchase date required for a claim. Additional restrictions and limitations apply, see warranty for details.</small></p>	
<p>More water when you need it most</p>	<p>Deep Fill</p>	<p>Selecting the Deep Fill option before starting your laundry maximizes the water level to make sure all your clothes get a thorough soak.*</p> <p><small>*Not available for use in the Bedding/Waterproof and Self Clean cycles.</small></p>	<p>Select the Deep Fill option to maximize the water level during the washing cycle.*</p> <p><small>*Not available for use in the Bedding/Waterproof and Self Clean cycles.</small></p>	



Features and Benefits: WA55CG7100* (Continued)

Headline	Feature Name	Long Body Copy	Short Body Copy	Associated Image
<p>Quiet washing anytime, any place</p>	<p>Vibration Reduction Technology+</p>	<p>Do your laundry in peace. Our innovative Vibration Reduction Technology+ reduces noise and vibration and creates a quiet washing experience.</p>	<p>Reduces noise and vibration for quiet washing.</p>	
<p>Keep your washer fresh</p>	<p>Self Clean</p>	<p>Keep your washer tub fresh and clean. Self Clean will notify you every 20 wash cycles when it is time for a cleaning.</p>	<p>Keep your washer tub fresh and clean.</p>	
<p>N/A</p>	<p>Soft-Close Lid</p>	<p>The thoughtfully designed Soft-Close Lid closes safely, gently, and quietly.</p>	<p>Soft-Close Lid closes safely, gently, and quietly.</p>	

Features and Benefits: WA55CG7100* (Continued)

Headline	Feature Name	Long Body Copy	Short Body Copy	Associated Image
N/A	Swirl+ Tub Interior	The improved tub pattern draws out more water during the rinse cycle and helps prevent clothes from snagging during the wash.	Improved tub pattern draws out water more quickly and helps prevent snags.	
N/A	ENERGY STAR® Certified	ENERGY STAR® Certified so you use less energy without sacrificing performance or functionality.	Eco-friendly and energy-efficient.	
Easy troubleshooting	Smart Care	<p>Easy troubleshooting from the convenience of your smartphone.* Smart Care interacts with your washer and dryer to perform an immediate diagnosis and offer quick solutions.</p> <p><small>*Requires Samsung Smart Washer/Dryer App. The Samsung Smart Washer/Dryer App supports Android OS 2.3.6 or later and iOS 3 or later for iPhone models. Samsung Smart Washer/Dryer App available in App Store and Play Store.</small></p>	<p>Easy troubleshooting from the convenience of your smartphone.*</p> <p><small>*Requires Samsung Smart Washer/Dryer App. The Samsung Smart Washer/Dryer App supports Android OS 2.3.6 or later and iOS 3 or later for iPhone models. Samsung Smart Washer/Dryer App available in App Store and Play Store.</small></p>	

Features and Benefits: WA55CG7100* (Continued)

Headline	Feature Name	Long Body Copy	Short Body Copy	Associated Image
<p>Easier use, for everyone</p>	<p>Accessibility (AUI, Braille)</p>	<p>Aiding the visually and hearing impaired, your washer and dryer now feature audio assistance, playing a different sound for each option, and braille right next to key control panel buttons.</p>	<p>Featuring audio assistance and braille, ensuring easy use for everyone.</p>	 <p>Braille and bumps Audio assistance</p>
<p>Perfect pair</p>	<p>Matching Dryer</p>	<p>Samsung washers and dryers team up to make light work of laundry day.</p>	<p>N/A</p>	

Lifestyle Images

**WA55CG7100AV
WA55CG7100AW**

**5.5 cu. ft. Extra-Large Capacity Smart Top Load
Washer with Super Speed Wash**

Primary Lifestyle Image



Additional Lifestyle Image



Product Specs

WA55CG7100AV
WA55CG7100AW

**5.5 cu. ft. Extra-Large Capacity Smart Top Load
Washer with Super Speed Wash**

Related Products and Accessories

Dryer Series	Type	Color
DVE55CG7100V	Electric Dryer	Brushed Black
DVE55CG7100W	Electric Dryer	White
DVG55CG7100V	Gas Dryer	Brushed Black
DVG55CG7100W	Gas Dryer	White

Agitator Version	Type	Color
WA54CG7105AV	Top Load Washer	Brushed Black
WA54CG7105AW	Top Load Washer	White

Spec Sheet

WA55CG7100 SAMSUNG

Samsung 5.5 cu. ft. Extra-Large Capacity
Smart Top Load Washer with Super Speed Wash



Available Colors

- Brushed Black**
WA55CG7100AV
- White**
WA55CG7100AW

Features

- 5.5 cu. ft. Extra-Large Capacity
- Wi-Fi Connectivity with SmartThings*
- Super Speed Wash
- Active Water Jet
- 20-Year Motor Warranty
- Deep Fill
- Vibration Reduction Technology+
- Swirl+ Tub Interior
- Self Clean
- Soft-Close Lid
- ENERGY STAR® Certified
- Smart Care™
- Accessibility (AUI, Braille)
- 750 RPM Maximum Spin Speed
- Digital Inverter Motor
- 17 Total Washing Cycles
- 10 Additional Washing Options

Convenience

- Child Lock
- Dispenser Trays: Main Wash, Softener, Bleach

Ratings

- ENERGY STAR® Rated:
- IMEF = 2.3
- IWF = 3.8
- 120 kWh/yr

Electrical Requirements

- 120 V / 60 Hz
- 15 Amps

Specifications

- 12 Preset Washing Cycles:** Normal, Bedding/Waterproof, Heavy Duty, Colors, Whites, Activewear, Delicates, Quick Wash, Self Clean, Rinse + Spin, Deep Wash, Downloaded
- 5 Downloadable Washing Cycles:** Permanent Press, Wool, Eco Cold, Denim, Power Rinse
- 10 Additional Washing Options:** Delay End, Presoak, Sound Off, Child Lock, Fabric Softener, Deep Fill, Super Speed, Smart Care, Smart Control, Spin Only

- 5 Temperature Settings:** Hot, Warmer, Warm, Cool, Cold

- 5 Spin Settings:** High, Medium High, Medium, Low, No Spin
- 5 Soil Settings:** Heavy, Heavy Medium, Normal, Low Medium, Light

- Warranty**
- One (1) Year Parts and Labor
- Three (3) Years Stainless Steel Tub (Part Only)
- Twenty (20) Years; Washing DIT (Digital Inverter Motor) Motor Part (Part Only)
- Five (5) Years Washing Motor Part (Part Only)

- Product Dimensions & Weight (WxHxD)**
- Dimensions: 27¹/₈" x 45¹³/₁₆" x 29⁷/₁₆"
- Weight: 134.5 lbs

- Shipping Dimensions & Weight (WxHxD)**
- Dimensions: 30¹/₈" x 47¹/₁₆" x 31¹/₄"
- Weight: 143.3 lbs

Washer	Model #	UPC Code
Brushed Black	WA55CG7100AV	887276739137
White	WA55CG7100AW	887276739144
Matching Electric Dryer		
Brushed Black	DV55CG7100V	887276740911
White	DV55CG7100W	887276740928
Matching Gas Dryer		
Brushed Black	DVG55CG7100V	887276740973
White	DVG55CG7100W	887276740980

*Requires wireless network, Samsung account and Samsung SmartThings App. The Samsung SmartThings App supports Android OS 4.0 (ICS) or later which is optimized for Samsung smartphones (Galaxy S and Galaxy Note series). This app also supports iOS 7 or later for iPhone models. Samsung SmartThings App available in App Store and Play Store.
 **Requires Samsung Smart Washer/Dryer App. The Samsung Smart Washer/Dryer App supports Android OS 2.3.6 or later and iOS 5 or later for iPhone models. Samsung Smart Washer/Dryer App available in App Store and Play Store.

Washer Spec Sheet - page 1

WA55CG7100 SAMSUNG

Samsung 5.5 cu. ft. Extra-Large Capacity
Smart Top Load Washer with Super Speed Wash

Dimensions

Required dimensions for installation:

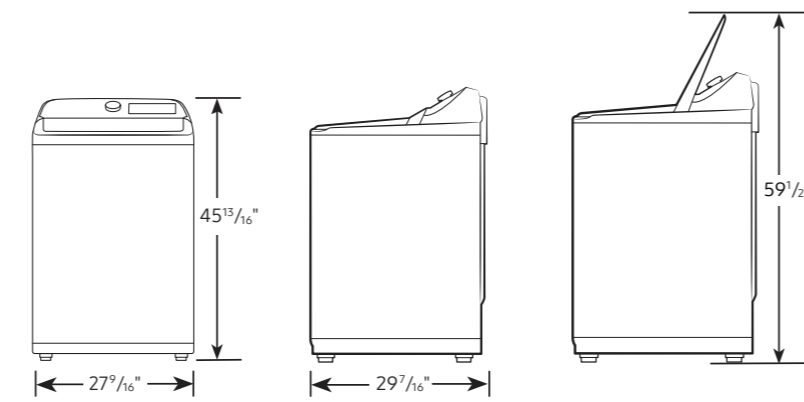

Installation Specifications – Side-by-Side

If the washer and dryer are installed together or the dryer alone, the closet front must have two unobstructed air openings for a combined minimum total area of 72-inch². Your washer alone does not require a specific air opening.

Alcove or closet installation
Minimum clearance for
closet and alcove installations:

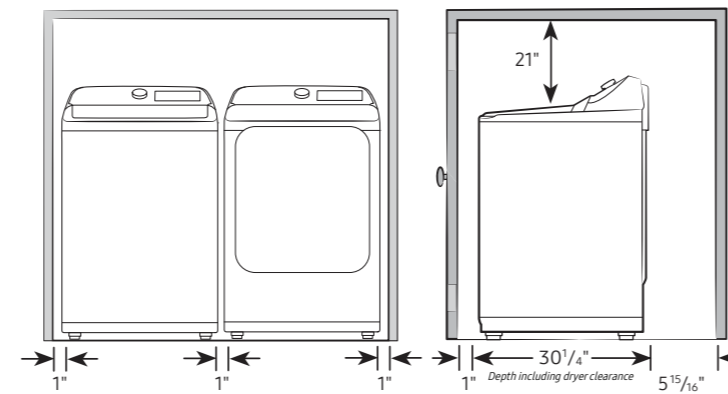

Connection Dimensions

Back view of washer

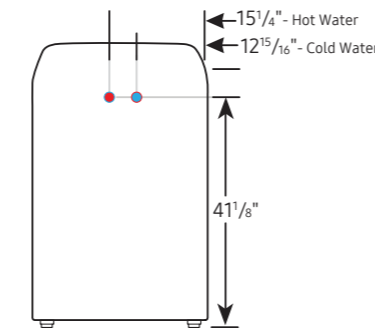

LEGEND:
● Hot Water Connection
● Cold Water Connection

Actual color may vary. Design, specifications, and color availability are subject to change without notice. Non-metric weights and measurements are approximate.

©2020 Samsung Electronics America, Inc. 85 Challenger Road, Ridgefield Park, NJ 07660. Tel: 800-SAMSUNG. samsung.com. Samsung is a registered trademark of Samsung Electronics Co., Ltd.

Washer Spec Sheet - page 2

Energy Guide

U.S. Government Federal law prohibits removal of this label before consumer purchase.

ENERGYGUIDE

Clothes Washer Capacity Class: Standard Samsung Models WA55CG75**A* WA55CG71**A* Capacity (tub volume): 5.5 cubic feet

Compare ONLY to other labels with yellow numbers.
Labels with yellow numbers are based on the same test procedures.

Estimated Yearly Energy Cost
(when used with an electric water heater)

\$17

\$4 Cost Range of Similar Models \$48

120 kWh
Estimated Yearly Electricity Use

\$10
Estimated Yearly Energy Cost
(when used with a natural gas water heater)

- Your cost will depend on your utility rates and use.
- Cost range based only on standard capacity models.
- Estimated energy cost based on six wash loads a week and a national average electricity cost of 14 cents per kWh and natural gas cost of \$1.21 per therm.

ftc.gov/energy



Energy Guide

User Manual and Warranty

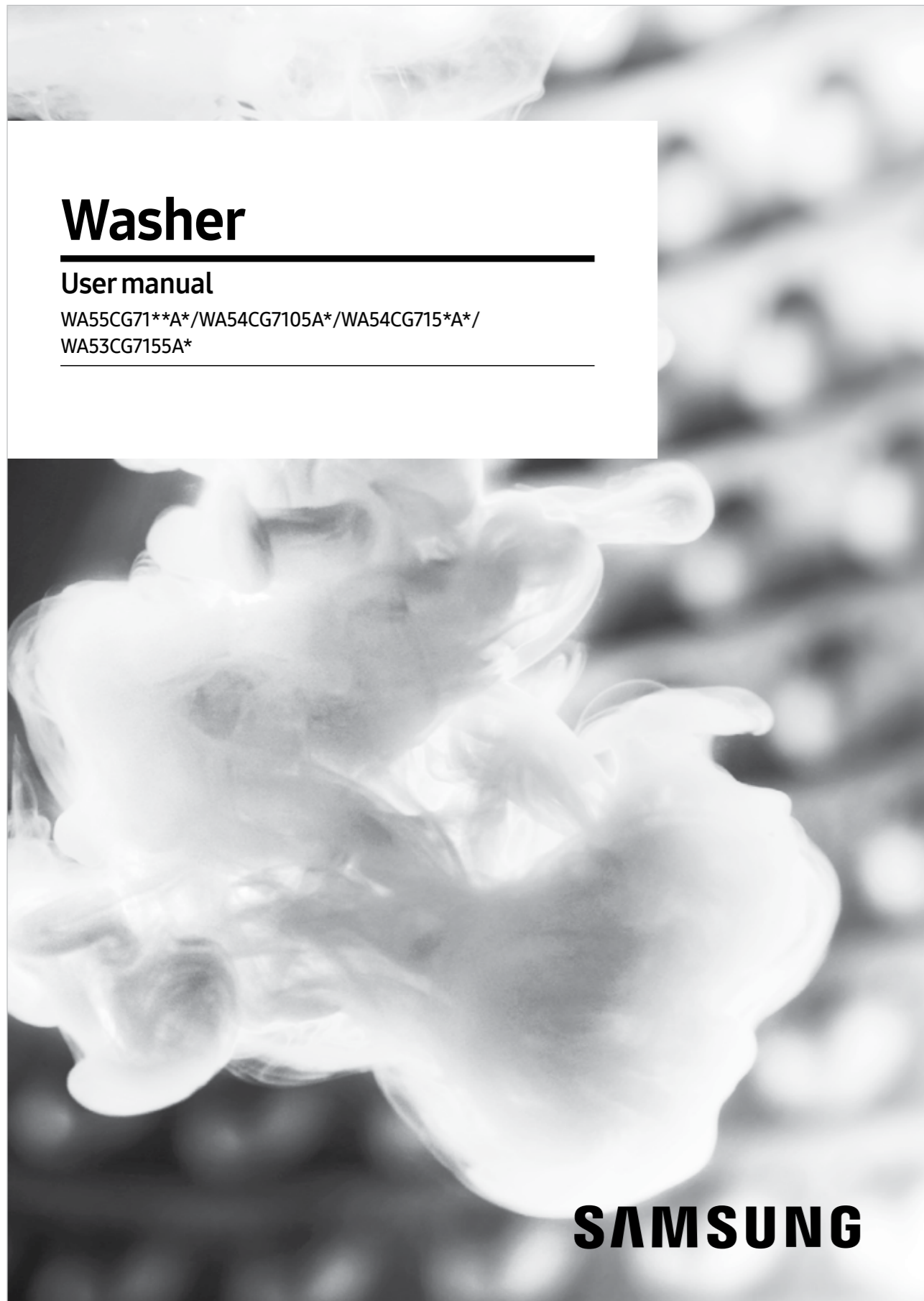

User Manual

LIMITED WARRANTY (U.S.A.) – SAMSUNG TOP LOAD WASHER

Models:

WA55CG7100AW
 WA55CG7100AV
 WA54CG7105AW
 WA54CG7105AV

LIMITED WARRANTY TO ORIGINAL PURCHASER WITH PROOF OF PURCHASE

This SAMSUNG brand product, as supplied and distributed by SAMSUNG ELECTRONICS AMERICA, INC. (SAMSUNG) and delivered new, in the original carton to the original consumer purchaser, is warranted by SAMSUNG against manufacturing defects in materials or workmanship for the limited warranty period, starting from the date of original purchase, of:

One (1) year Parts and labor

Three (3) years Stainless tub part (Part Only)

Twenty (20) years; Washing DIT (Digital Inverter Motor) motor part (Part Only)

Five (5) years Washing AC motor part (Part Only)

This limited warranty is valid only on products purchased and used in the United States that have been installed, operated, and maintained according to the instructions attached to or furnished with the product. To receive warranty service, the purchaser must contact SAMSUNG at the address or phone number provided below for problem determination and service procedures. Warranty service can only be performed by a SAMSUNG authorized service center. The original dated bill of sale must be presented upon request as proof of purchase to SAMSUNG or SAMSUNG's authorized service center to receive warranty service.

SAMSUNG will provide in-home service within the contiguous United States during the warranty period at no charge, subject to availability of SAMSUNG authorized servicers within the customer's geographic area. If in-home service is not available, SAMSUNG may elect, at its option, to provide transportation of the product to and from an authorized service center. If the product is located in an area where service by a SAMSUNG authorized servicer is not available, you may be responsible for a trip charge or require to bring the product to a SAMSUNG authorized service center for service.

To receive in-home service, product must be unobstructed and accessible to the service agent.

During the applicable warranty period, a product will be repaired, replaced, or the purchase price refunded, at the sole option of SAMSUNG. SAMSUNG may use new or reconditioned parts in repairing a product, or replace the product with a new or reconditioned product. Replacement parts and products are warranted for the remaining portion of the original product's warranty or ninety (90) days, whichever is longer. All replaced parts and products are the property of SAMSUNG and you must return them to SAMSUNG.

This limited warranty covers manufacturing defects in materials or workmanship encountered in normal household, noncommercial use of this product and shall not cover the following: damage that occurs in shipment, delivery, installation, and uses for which this product was not intended; damage caused by unauthorized modification

Warranty

Feature Icons

**WA55CG7100AV
WA55CG7100AW**

**5.5 cu. ft. Extra-Large Capacity Smart Top Load
Washer with Super Speed Wash**

Feature Icons

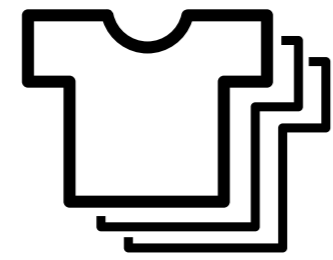

Extra-Large
5.5 cu. ft. Capacity

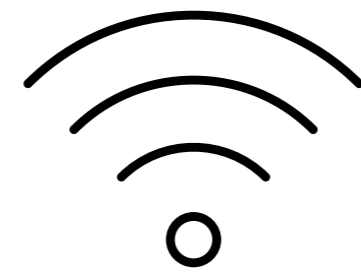

Wi-Fi Connectivity
with SmartThings



Super Speed Wash



Active WaterJet



20-Year Motor
Warranty*

*20-year warranty limited to the Digital Inverter Motor of washers purchased on 7/1/2022 or later. Purchase receipt indicating purchase date required for a claim. Additional restrictions and limitations apply, see warranty for details.

Product Overview

WA54CG7105AV
WA54CG7105AW

**5.4 cu. ft. Extra-Large Capacity Smart Top Load Washer
with ActiveWave™ Agitator and Super Speed Wash**

Product Overview

Product Title

5.4 cu. ft. Extra-Large Capacity Smart Top Load Washer with ActiveWave™ Agitator and Super Speed Wash

Product Description

Samsung's 5.4 cu. ft. Extra-Large Capacity Top Load Washing Machine features our ActiveWave™ Agitator that is designed to reduce noise, vibration, and tangling while delivering powerful cleaning. Super Speed Wash powerfully cleans a full load of laundry in just 28 minutes* without sacrificing cleaning performance. With Wi-Fi connectivity, you can remotely start, stop, or delay your smart washer from our simple-to-use SmartThings App.** Active WaterJet, a built-in water faucet, lets you easily pretreat heavily soiled and stained clothes.

- ActiveWave™ Agitator reduces noise, vibration, and tangling while powerfully cleaning
- Super Speed Wash – Thoroughly wash a full load in just 28 minutes*
- Wi-Fi Connectivity with SmartThings – Remotely start, schedule, and receive end-of-cycle alerts to your smartphone**
- Active WaterJet – Easily pretreat with a built-in water faucet

* Based on using Super Speed wash on a Normal Cycle with an 8lb load.

** Requires wireless network, Samsung account and SmartThings App. The Samsung SmartThings App supports Android OS 4.0 (ICS) or later which is optimized for Samsung smartphones (Galaxy S and Galaxy Note series). This app also supports iOS 7 or later for iPhone models. SmartThings App available in App Store and Play Store.

Easy Ads Links

Brushed Black Washer: <https://dam.gettyimages.com/p/z0c3461/digital-appliances?o=AND&q=WA54CG7105AV>

White Washer: <https://dam.gettyimages.com/p/z0c3461/digital-appliances?o=AND&q=WA54CG7105AW>

Available Colors



Brushed Black

Model Number: WA54CG7105AV

UPC: 887276739106



White

Model Number: WA54CG7105AW

UPC: 887276739113



Carousel Image Order

WA54CG7105AV



Carousel Image Order

WA54CG7105AW





Product Messaging



**WA54CG7105AV
WA54CG7105AW**

**5.4 cu. ft. Extra-Large Capacity Smart Top Load Washer
with ActiveWave™ Agitator and Super Speed Wash**

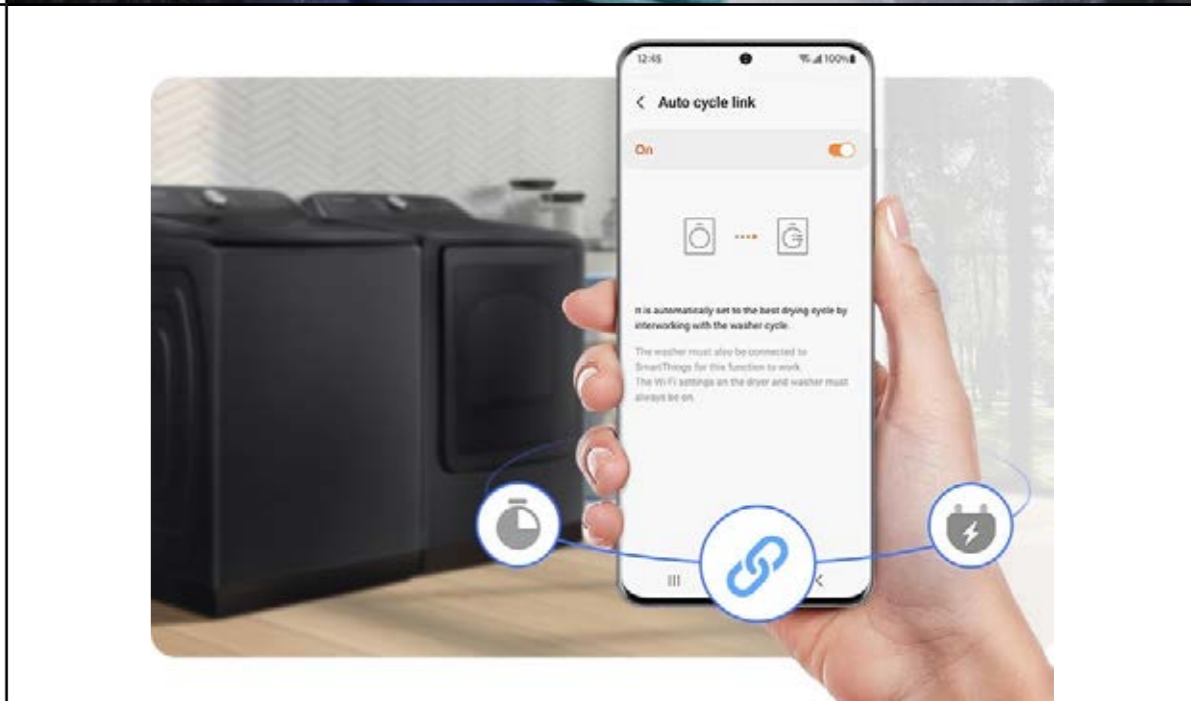

Features and Benefits: WA54CG7105*

Headline	Feature Name	Long Body Copy	Short Body Copy	Associated Image
<p>Wash more items in a single load</p>	<p>Extra-Large 5.4 cu. ft. Capacity</p>	<p>Fewer loads, less time in the laundry room, and more time doing the things you love.</p>	<p>Fewer loads, less time in the laundry room.</p>	
<p>A powerful, yet peaceful clean</p>	<p>ActiveWave™ Agitator</p>	<p>Samsung's ActiveWave™ Agitator is designed to reduce noise, vibration, and tangling while delivering powerful cleaning.</p>	<p>Designed to reduce noise, vibration and tangling while powerfully cleaning.</p>	
<p>Connect with SmartThings</p>	<p>Wi-Fi Connectivity with SmartThings</p>	<p>Wi-Fi connected so you can receive end-of-cycle alerts, remotely start or stop your washing, schedule cycles on your time, and more, right from your smartphone with the SmartThings App.*</p> <p><small>*Requires wireless network, Samsung account and SmartThings App. The Samsung SmartThings App supports Android OS 4.0 (ICS) or later which is optimized for Samsung smartphones (Galaxy S and Galaxy Note series). This app also supports iOS 7 or later for iPhone models. SmartThings App available in App Store and Play Store.</small></p>	<p>With Wi-Fi connectivity, remotely start, stop, or delay your washer from one simple-to-use app. Get energy usage notifications and so much more.*</p> <p><small>*Requires wireless network, Samsung account and SmartThings App. The Samsung SmartThings App supports Android OS 4.0 (ICS) or later which is optimized for Samsung smartphones (Galaxy S and Galaxy Note series). This app also supports iOS 7 or later for iPhone models. SmartThings App available in App Store and Play Store.</small></p>	



Features and Benefits: WA54CG7105* (Continued)

Headline	Feature Name	Long Body Copy	Short Body Copy	Associated Image
<p>Wash a full load in just 28 minutes*</p> <p><small>*Based on using Super Speed on a Normal Cycle with an 8lb load.</small></p>	<p>Super Speed Wash</p>	<p>Wash a full load of laundry in just 28 minutes* without sacrificing cleaning performance.</p> <p><small>*Based on using Super Speed wash on a Normal Cycle with an 8lb load.</small></p>	<p>Powerful cleaning in just 28 minutes.*</p> <p><small>*Based on using Super Speed Wash on a Normal Cycle with an 8lb load.</small></p>	
<p>Pretreat with the push of a button</p>	<p>Active WaterJet</p>	<p>A built-in water faucet lets you easily pretreat soiled or heavily stained clothes with the press of a button. Scrub items right inside your washer, no laundry room sink needed.</p>	<p>Built-in water faucet lets you easily pretreat heavily soiled and stained clothes.</p>	
<p>Purchase with confidence</p>	<p>20-Year Motor Warranty</p>	<p>Purchase with confidence any Samsung Washer model with a Digital Inverter Motor and receive a 20 year warranty on the motor.*</p> <p><small>*20-year warranty limited to the Digital Inverter Motor of washers purchased on 7/1/2022 or later. Purchase receipt indicating purchase date required for a claim. Additional restrictions and limitations apply, see warranty for details.</small></p>	<p>Purchase with confidence any Samsung Washer model with a Digital Inverter Motor and receive a 20 year warranty on the motor.*</p> <p><small>*20-year warranty limited to the Digital Inverter Motor of washers purchased on 7/1/2022 or later. Purchase receipt indicating purchase date required for a claim. Additional restrictions and limitations apply, see warranty for details.</small></p>	



Features and Benefits: WA54CG7105* (Continued)

Headline	Feature Name	Long Body Copy	Short Body Copy	Associated Image
<p>More water when you need it most</p>	<p>Deep Fill</p>	<p>Selecting the Deep Fill option before starting your laundry maximizes the water level to make sure all your clothes get a thorough soak.*</p> <p><small>*Not available for use in the Bedding/Waterproof and Self Clean cycles.</small></p>	<p>Select the Deep Fill option to maximize the water level during the washing cycle.*</p> <p><small>*Not available for use in the Bedding/Waterproof and Self Clean cycles.</small></p>	
<p>Quiet washing anytime, any place</p>	<p>Vibration Reduction Technology+</p>	<p>Do your laundry in peace. Our innovative Vibration Reduction Technology+ reduces noise and vibration and creates a quiet washing experience.</p>	<p>Reduces noise and vibration for quiet washing.</p>	
<p>Keep your washer fresh</p>	<p>Self Clean</p>	<p>Keep your washer tub fresh and clean. Self Clean will notify you every 20 wash cycles when it is time for a cleaning.</p>	<p>Keep your washer tub fresh and clean.</p>	

Features and Benefits: WA54CG7105* (Continued)

Headline	Feature Name	Long Body Copy	Short Body Copy	Associated Image
N/A	Soft-Close Lid	The thoughtfully designed Soft-Close Lid closes safely, gently, and quietly.	Soft-Close Lid closes safely, gently, and quietly.	
N/A	Swirl+ Tub Interior	The improved tub pattern draws out more water during the rinse cycle and helps prevent clothes from snagging during the wash.	Improved tub pattern draws out water more quickly and helps prevent snags.	
N/A	ENERGY STAR® Certified	ENERGY STAR® Certified so you use less energy without sacrificing performance or functionality.	Eco-friendly and energy-efficient.	

Features and Benefits: WA54CG7105* (Continued)

Headline	Feature Name	Long Body Copy	Short Body Copy	Associated Image
<p>Easy troubleshooting</p>	<p>Smart Care</p>	<p>Easy troubleshooting from the convenience of your smartphone.* Smart Care interacts with your washer and dryer to perform an immediate diagnosis and offer quick solutions.</p> <p><small>*Requires Samsung Smart Washer/Dryer App. The Samsung Smart Washer/Dryer App supports Android OS 2.3.6 or later and iOS 3 or later for iPhone models. Samsung Smart Washer/Dryer App available in App Store and Play Store.</small></p>	<p>Easy troubleshooting from the convenience of your smartphone.*</p> <p><small>*Requires Samsung Smart Washer/Dryer App. The Samsung Smart Washer/Dryer App supports Android OS 2.3.6 or later and iOS 3 or later for iPhone models. Samsung Smart Washer/Dryer App available in App Store and Play Store.</small></p>	
<p>Easier use, for everyone</p>	<p>Accessibility (AUI, Braille)</p>	<p>Aiding the visually and hearing impaired, your washer and dryer now feature audio assistance, playing a different sound for each option, and braille right next to key control panel buttons.</p>	<p>Featuring audio assistance and braille, ensuring easy use for everyone.</p>	
<p>Perfect pair</p>	<p>Matching Dryer</p>	<p>Samsung washers and dryers team up to make light work of laundry day.</p>	<p>N/A</p>	

Product Specs

**WA54CG7105AV
WA54CG7105AW**

**5.4 cu. ft. Extra-Large Capacity Smart Top Load Washer
with ActiveWave™ Agitator and Super Speed Wash**

Related Products and Accessories

Dryer Series	Type	Color
DVE55CG7100V	Electric Dryer	Brushed Black
DVE55CG7100W	Electric Dryer	White
DVG55CG7100V	Gas Dryer	Brushed Black
DVG55CG7100W	Gas Dryer	White

Impeller Version	Type	Color
WA55CG7100AV	Top Load Washer	Brushed Black
WA55CG7100AW	Top Load Washer	White

Spec Sheet

WA54CG7105 SAMSUNG

Samsung 5.4 cu. ft. Extra-Large Capacity Smart Top Load Washer with ActiveWave™ Agitator and Super Speed Wash



- Available Colors**
- Brushed Black**
WA54CG7105AV
 - White**
WA54CG7105AW

Features

- 5.4 cu. ft. Extra-Large Capacity
- ActiveWave™ Agitator
- Wi-Fi Connectivity with SmartThings*
- Super Speed Wash
- Active Water Jet
- 20-Year Motor Warranty
- Deep Fill
- Vibration Reduction Technology+
- Swirl+ Tub Interior
- Self Clean
- Soft-Close Lid
- ENERGY STAR® Certified
- Smart Care™
- Accessibility (AUI, Braille)
- 750 RPM Maximum Spin Speed
- Digital Inverter Motor
- 17 Total Washing Cycles
- 10 Additional Washing Options

Specifications

- 12 Preset Washing Cycles:** Normal, Bedding/Waterproof, Heavy Duty, Colors, Whites, Activewear, Delicates, Quick Wash, Self Clean, Rinse + Spin, Deep Wash, Downloaded
- 5 Downloadable Washing Cycles:** Permanent Press, Wool, Eco Cold, Denim, Power Rinse
- 10 Additional Washing Options:** Delay End, Presoak, Sound Off, Child Lock, Fabric Softener, Deep Fill, Super Speed, Smart Care, Smart Control, Spin Only

- 5 Spin Settings:** High, Medium High, Medium, Low, No Spin
- 5 Soil Settings:** Heavy, Heavy Medium, Normal, Low Medium, Light

- Warranty**
- One (1) Year Parts and Labor
 - Three (3) Years Stainless Steel Tub (Part Only)
 - Twenty (20) Years; Washing DIT (Digital Inverter Motor) Motor Part (Part Only)
 - Five (5) Years Washing Motor Part (Part Only)

Product Dimensions & Weight (WxHxD)
Dimensions: 27¹/₈" x 45¹³/₁₆" x 29⁷/₁₆"
Weight: 136.7 lbs

Shipping Dimensions & Weight (WxHxD)
Dimensions: 30¹/₈" x 47¹/₁₆" x 31¹/₄"
Weight: 145.5 lbs

Temperature Settings: Hot, Warmer, Warm, Cool, Cold

Washer	Model #	UPC Code
Brushed Black	WA54CG7105AV	887276739106
White	WA54CG7105AW	887276739113

Matching Electric Dryer

Brushed Black	DVE55CG7100V	887276740911
White	DVE55CG7100W	887276740928

Matching Gas Dryer

Brushed Black	DVG55CG7100V	887276740973
White	DVG55CG7100W	887276740980

Convenience

- Child Lock
- Dispenser Trays: Main Wash, Softener, Bleach

Ratings

ENERGY STAR® Rated:

 IMEF = 2.3
 IWF = 3.8
 120 kWh/yr

Electrical Requirements

120 V / 60 Hz
 15 Amps

*Requires wireless network, Samsung account and Samsung SmartThings App. The Samsung SmartThings App supports Android OS 4.0 (ICS) or later which is optimized for Samsung smartphones (Galaxy S and Galaxy Note series). This app also supports iOS 7 or later for iPhone models. Samsung SmartThings App available in App Store and Play Store.
 **Requires Samsung Smart Washer/Dryer App. The Samsung Smart Washer/Dryer App supports Android OS 2.3.6 or later and iOS 5 or later for iPhone models. Samsung Smart Washer/Dryer App available in App Store and Play Store.

WA54CG7105 SAMSUNG

Samsung 5.4 cu. ft. Extra-Large Capacity Smart Top Load Washer with ActiveWave™ Agitator and Super Speed Wash

Dimensions
Required dimensions for installation:

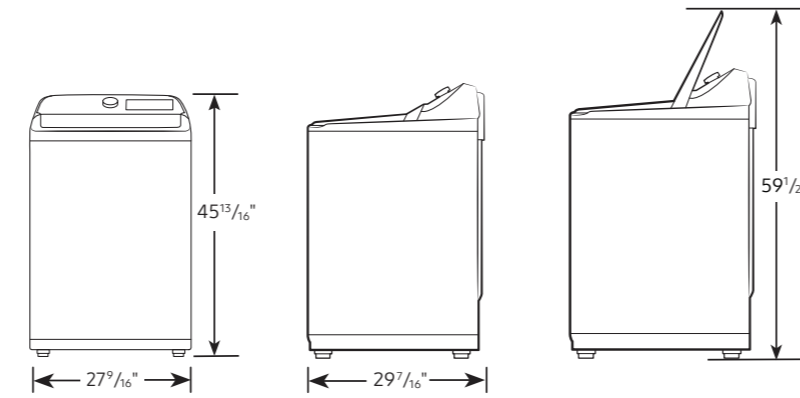

Installation Specifications – Side-by-Side

If the washer and dryer are installed together or the dryer alone, the closet front must have two unobstructed air openings for a combined minimum total area of 72-inch². Your washer alone does not require a specific air opening.

Alcove or closet installation
 Minimum clearance for
 closet and alcove installations:

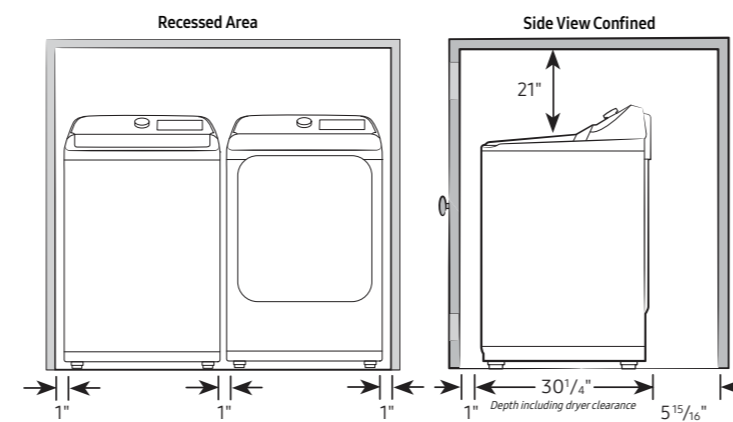

Connection Dimensions

Back view of washer

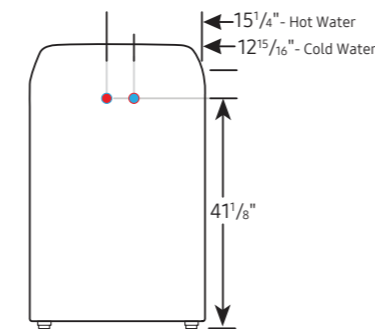

LEGEND:
 Hot Water Connection
 Cold Water Connection

Actual color may vary. Design, specifications, and color availability are subject to change without notice. All metrics, weights and measurements are approximate.
 ©2023 Samsung Electronics America, Inc.
 65 Challenger Road, Ridgefield Park, NJ 07660
 Tel: 800-SAMSUNG, samsung.com, Samsung is a registered trademark of Samsung Electronics Co., Ltd.

Energy Guide

U.S. Government Federal law prohibits removal of this label before consumer purchase.

ENERGYGUIDE

Clothes Washer Capacity Class: Standard Samsung Models WA55CG71**A* Capacity (tub volume): 5.5 cubic feet

Compare ONLY to other labels with yellow numbers.
Labels with yellow numbers are based on the same test procedures.

Estimated Yearly Energy Cost
(when used with an electric water heater)

\$17

\$4 Cost Range of Similar Models \$48

120 kWh
Estimated Yearly Electricity Use

\$10
Estimated Yearly Energy Cost
(when used with a natural gas water heater)

- Your cost will depend on your utility rates and use.
- Cost range based only on standard capacity models.
- Estimated energy cost based on six wash loads a week and a national average electricity cost of 14 cents per kWh and natural gas cost of \$1.21 per therm.

ftc.gov/energy



Energy Guide

User Manual and Warranty

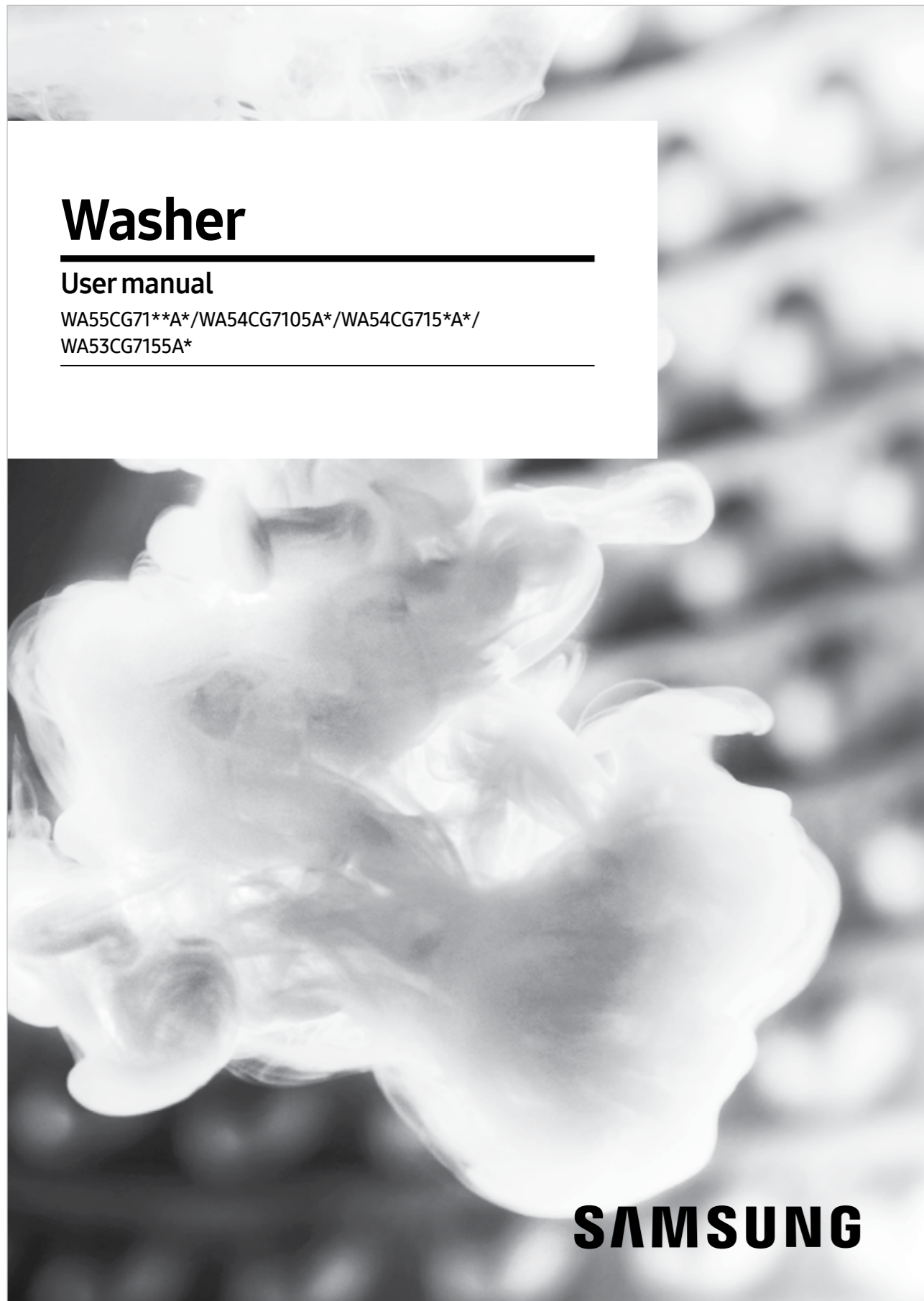

User Manual

LIMITED WARRANTY (U.S.A.) – SAMSUNG TOP LOAD WASHER

Models:
WA55CG7100AW
WA55CG7100AV
WA54CG7105AW
WA54CG7105AV

LIMITED WARRANTY TO ORIGINAL PURCHASER WITH PROOF OF PURCHASE

This SAMSUNG brand product, as supplied and distributed by SAMSUNG ELECTRONICS AMERICA, INC. (SAMSUNG) and delivered new, in the original carton to the original consumer purchaser, is warranted by SAMSUNG against manufacturing defects in materials or workmanship for the limited warranty period, starting from the date of original purchase, of:

One (1) year Parts and labor
Three (3) years Stainless tub part (Part Only)
Twenty (20) years; Washing DIT (Digital Inverter Motor) motor part (Part Only)
Five (5) years Washing AC motor part (Part Only)

This limited warranty is valid only on products purchased and used in the United States that have been installed, operated, and maintained according to the instructions attached to or furnished with the product. To receive warranty service, the purchaser must contact SAMSUNG at the address or phone number provided below for problem determination and service procedures. Warranty service can only be performed by a SAMSUNG authorized service center. The original dated bill of sale must be presented upon request as proof of purchase to SAMSUNG or SAMSUNG's authorized service center to receive warranty service.

SAMSUNG will provide in-home service within the contiguous United States during the warranty period at no charge, subject to availability of SAMSUNG authorized servicers within the customer's geographic area. If in-home service is not available, SAMSUNG may elect, at its option, to provide transportation of the product to and from an authorized service center. If the product is located in an area where service by a SAMSUNG authorized servicer is not available, you may be responsible for a trip charge or require to bring the product to a SAMSUNG authorized service center for service.

To receive in-home service, product must be unobstructed and accessible to the service agent.

During the applicable warranty period, a product will be repaired, replaced, or the purchase price refunded, at the sole option of SAMSUNG. SAMSUNG may use new or reconditioned parts in repairing a product, or replace the product with a new or reconditioned product. Replacement parts and products are warranted for the remaining portion of the original product's warranty or ninety (90) days, whichever is longer. All replaced parts and products are the property of SAMSUNG and you must return them to SAMSUNG.

This limited warranty covers manufacturing defects in materials or workmanship encountered in normal household, noncommercial use of this product and shall not cover the following: damage that occurs in shipment, delivery, installation, and uses for which this product was not intended; damage caused by unauthorized modification

Warranty

Feature Icons

WA54CG7105AV
WA54CG7105AW

**5.4 cu. ft. Extra-Large Capacity Smart Top Load Washer
with ActiveWave™ Agitator and Super Speed Wash**

Feature Icons

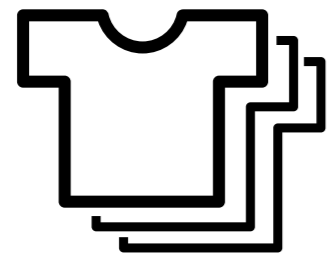

Extra-Large
5.4 cu. ft. Capacity

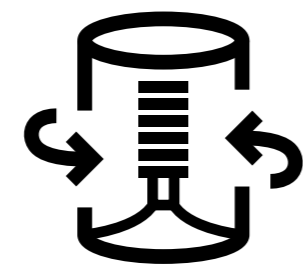

ActiveWave™ Agitator

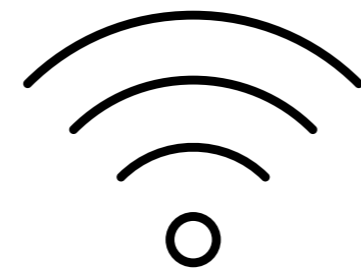

Wi-Fi Connectivity
with SmartThings



Super Speed Wash



Active WaterJet



20-Year Motor
Warranty*

*20-year warranty limited to the Digital Inverter Motor of washers purchased on 7/1/2022 or later. Purchase receipt indicating purchase date required for a claim. Additional restrictions and limitations apply, see warranty for details.

Product Overview

DVE55CG7100V / DVG55CG7100V
DVE55CG7100W / DVG55CG7100W

7.4 cu. ft. Smart Electric Dryer with Steam Sanitize+
7.4 cu. ft. Smart Gas Dryer with Steam Sanitize+

Product Overview

Product Titles

DVE55CG7100 - 7.4 cu. ft. Smart Electric Dryer with Steam Sanitize+

Electric Dryer Description

Samsung's Large Capacity Electric Dryer is equipped with Steam Sanitize+, which removes 95% of pollen* from fabric, while Multi-Steam refreshes clothing and relaxes light wrinkles. With Wi-Fi connectivity, you can remotely start, stop, or delay your dryer from our simple-to-use SmartThings App.** Sensor Dry automatically optimizes the time and temperature of the drying cycle to help prevent overdrying while avoiding excess energy use.

* Testing based on Samsung internal protocols. Results provided to and interpreted by Intertek. Individual results may vary.

** Requires wireless network, Samsung account and SmartThings App. The Samsung SmartThings App supports Android OS 4.0 (ICS) or later which is optimized for Samsung smartphones (Galaxy S and Galaxy Note series). This app also supports iOS 7 or later for iPhone models. SmartThings App available in App Store and Play Store. Only monitoring enabled on gas dryers for safety reasons.

Electric & Gas Dryer Bullets

- Steam Sanitize+ – Sanitize clothing* and reduce wrinkles and odors
- Wi-Fi Connectivity with SmartThings – Remotely start, schedule, and receive end-of-cycle alerts to your smartphone**
- Sensor Dry – Helps prevent overdrying for optimal fabric care

DVG55CG7100 - 7.4 cu. ft. Smart Gas Dryer with Steam Sanitize+

Gas Dryer Description

Samsung's Large Capacity Gas Dryer is equipped with Steam Sanitize+, which removes 95% of pollen* from fabric, while Multi-Steam refreshes clothing and relaxes light wrinkles. With Wi-Fi connectivity, you can remotely monitor your dryer from our simple-to-use SmartThings App.** Sensor Dry automatically optimizes the time and temperature of the drying cycle to help prevent overdrying while avoiding excess energy use.



Easy Ads Links

Brushed Black Electric and Gas Dryer: [https://dam.gettyimages.com/p/z0c3461/digital-appliances?o=AND&q=DVE\(G\)55CG7100V](https://dam.gettyimages.com/p/z0c3461/digital-appliances?o=AND&q=DVE(G)55CG7100V)

White Electric and Gas Dryer: [https://dam.gettyimages.com/p/z0c3461/digital-appliances?o=AND&q=DVE\(G\)55CG7100W](https://dam.gettyimages.com/p/z0c3461/digital-appliances?o=AND&q=DVE(G)55CG7100W)

Available Colors

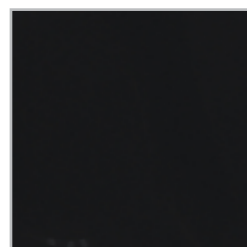

Brushed Black

Electric Dryer Model Number: DVE55CG7100V

Electric Dryer UPC: 887276740911

Gas Dryer Model Number: DVG55CG7100V

Gas Dryer UPC: 887276740973



White

Electric Dryer Model Number: DVE55CG7100W

Electric Dryer UPC: 887276740928

Gas Dryer Model Number: DVG55CG7100W

Gas Dryer UPC: 887276740980

Carousel Image Order

DVE55CG7100V / DVG55CG7100V



Carousel Image Order

DVE55CG7100W / DVG55CG7100W





Product Messaging

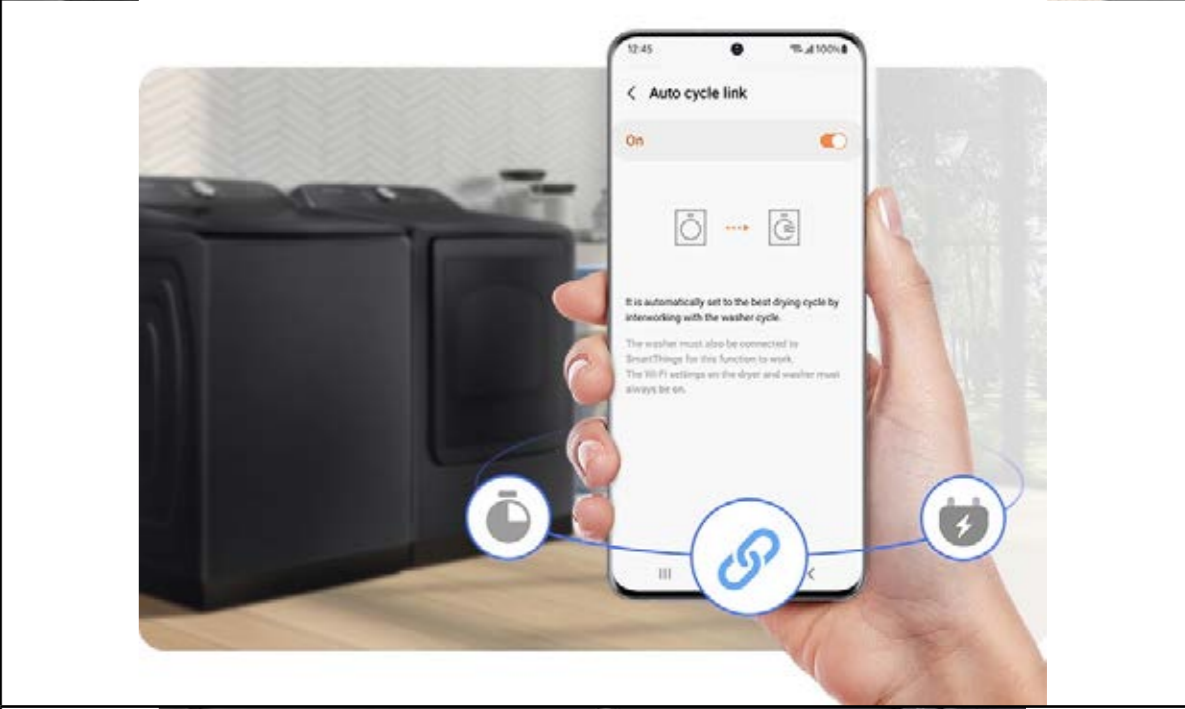

DVE55CG7100V / DVG55CG7100V
DVE55CG7100W / DVG55CG7100W

7.4 cu. ft. Smart Electric Dryer with Steam Sanitize+
7.4 cu. ft. Smart Gas Dryer with Steam Sanitize+



Features and Benefits: DVE(G)55CG7100*

Headline	Feature Name	Long Body Copy	Short Body Copy	Associated Image
<p>Freshen Up Clothes</p>	<p>Steam Sanitize+</p>	<p>Our Steam Sanitize+ cycle removes 95% of pollen* from fabric, while Multi-Steam refreshes clothing and relaxes light wrinkles.</p> <p><small>*Testing based on Samsung internal protocols. Results provided to and interpreted by Intertek. Individual results may vary.</small></p>	<p>Removes 95% of pollen from fabric,* relaxes light wrinkles, and refreshes clothing.</p> <p><small>*Testing based on Samsung internal protocols. Results provided to and interpreted by Intertek. Individual results may vary.</small></p>	
<p>Connect with SmartThings</p>	<p>Wi-Fi Connectivity with SmartThings</p>	<p>Wi-Fi connected so you can receive end-of-cycle alerts, remotely start or stop your washing, schedule cycles on your time, and more, right from your smartphone with the SmartThings App.*</p> <p><small>*Requires wireless network, Samsung account and SmartThings App. The Samsung SmartThings App supports Android OS 4.0 (ICS) or later which is optimized for Samsung smartphones (Galaxy S and Galaxy Note series). This app also supports iOS 7 or later for iPhone models. SmartThings App available in App Store and Play Store.</small></p>	<p>With Wi-Fi connectivity, remotely start, stop, or delay your washer from one simple-to-use app. Get energy usage notifications and so much more.*</p> <p><small>*Requires wireless network, Samsung account and SmartThings App. The Samsung SmartThings App supports Android OS 4.0 (ICS) or later which is optimized for Samsung smartphones (Galaxy S and Galaxy Note series). This app also supports iOS 7 or later for iPhone models. SmartThings App available in App Store and Play Store.</small></p>	
<p>Worry-free drying</p>	<p>Sensor Dry</p>	<p>Automatically optimizes the time and temperature of your drying cycle to protect your clothes from heat damage, while avoiding excess energy use.</p>	<p>Helps prevent overdrying for optimal fabric care.</p>	

Features and Benefits: DVE(G)55CG7100* (Continued)

Headline	Feature Name	Long Body Copy	Short Body Copy	Associated Image
<p>Easy troubleshooting</p>	<p>Smart Care</p>	<p>Easy troubleshooting from the convenience of your smartphone.* Smart Care interacts with your washer and dryer to perform an immediate diagnosis and offer quick solutions.</p> <p><small>*Requires Samsung Smart Washer/Dryer App. The Samsung Smart Washer/Dryer App supports Android OS 2.3.6 or later and iOS 3 or later for iPhone models. Samsung Smart Washer/Dryer App available in App Store and Play Store.</small></p>	<p>Easy troubleshooting from the convenience of your smartphone.*</p> <p><small>*Requires Samsung Smart Washer/Dryer App. The Samsung Smart Washer/Dryer App supports Android OS 2.3.6 or later and iOS 3 or later for iPhone models. Samsung Smart Washer/Dryer App available in App Store and Play Store.</small></p>	
<p>Put an end to stray socks</p>	<p>Internal Drum Light</p>	<p>An internal drum light lets you see the contents of your dryer more clearly, resulting in fewer missed socks or small items.</p>	<p>An internal drum light lets you see the contents of your dryer more clearly.</p>	
<p>Flexible opening</p>	<p>Reversible Dryer Door</p>	<p>Choose which way your dryer door opens to better suit your laundry room layout.</p>	<p>Choose which way your dryer door opens.</p>	

Features and Benefits: DVE(G)55CG7100* (Continued)

Headline	Feature Name	Long Body Copy	Short Body Copy	Associated Image
<p>Easier use, for everyone</p>	<p>Accessibility (AUI, Braille)</p>	<p>Aiding the visually and hearing impaired, your washer and dryer now feature audio assistance, playing a different sound for each option, and braille right next to key control panel buttons.</p>	<p>Featuring audio assistance and braille, ensuring easy use for everyone.</p>	
<p>Dry more items in a single load</p>	<p>Large 7.4 cu. ft. Capacity</p>	<p>Fewer loads, less time in the laundry room, and more time doing the things you love.</p>	<p>Fewer loads, less time in the laundry room.</p>	
<p>Stop the fluff</p>	<p>Lint Filter Indicator</p>	<p>Worry less about lint or fluff blocking the dryer's air intake. The control panel provides a helpful reminder to clean the filter to keep your dryer running smoothly.</p>	<p>The control panel lets you know when it's time to clean the filter.</p>	

Features and Benefits: DVE(G)55CG7100* (Continued)

Headline	Feature Name	Long Body Copy	Short Body Copy	Associated Image
<p>Perfect pair</p>	<p>Matching Washer</p>	<p>Samsung washers and dryers team up to make light work of laundry day.</p>	<p>N/A</p>	

Product Specs

DVE55CG7100V / DVG55CG7100V
DVE55CG7100W / DVG55CG7100W

7.4 cu. ft. Smart Electric Dryer with Steam Sanitize+
7.4 cu. ft. Smart Gas Dryer with Steam Sanitize+

Related Products and Accessories

Impeller Version	Agitator Version	Type	Color
WA55CG7100AV	WA54CG7105AV	Top Load Washer	Brushed Black
WA55CG7100AW	WA54CG7105AW	Top Load Washer	White

Gas Dryer Conversion Kit	Dryer Vent Kit
LPKIT-4	DV-2A

Spec Sheets

DVE55CG7100

Samsung 7.4 cu. ft. Smart Electric Dryer with Steam Sanitize+



SAMSUNG

Available Colors

- Brushed Black
DVE55CG7100V
- White
DVE55CG7100W

Features

- Steam Sanitize+
- Wi-Fi Connectivity with SmartThings*
- Sensor Dry
- Smart Care™
- Interior Drum Light
- Reversible Door
- Accessibility (AUI, Braille)
- Large 7.4 cu. ft. Capacity
- Lint Filter Indicator
- 21 Total Drying Cycles
- 10 Options
- 5 Temperature Settings
- 4-Way Venting (Back, Bottom, Left, Right)

Convenience

- Child Lock
- Lint Filter Indicator

Rating

644 kWh/yr

Electrical Requirements

240 V / 60 Hz
30 Amps

Specifications

12 Preset Drying Cycles:
Refresh, Steam Sanitize+, Normal, Heavy Duty, Permanent Press, Bedding, Delicates, Activewear, Time Dry, Air Fluff, Quick Dry, Downloaded

5 Dry Levels:
More Dry, Normal-More Dry, Normal Dry, Normal-Less Dry, Less Dry

Warranty
One (1) Year Parts and Labor

Product Dimensions & Weight (WxHxD)
Dimensions: 27" x 45³/₁₆" x 30¹/₄"
Weight: 119.0 lbs

Shipping Dimensions & Weight (WxHxD)
Dimensions: 29¹/₂" x 48⁷/₈" x 31¹/₁₆"
Weight: 127.9 lbs

Electric Dryer	Model #	UPC Code
Brushed Black	DVE55CG7100V	887276740971
White	DVE55CG7100W	887276740928

Gas Dryer	Model #	UPC Code
Brushed Black	DVG55CG7100V	887276740973
White	DVG55CG7100W	887276740980

Matching Washer	Model #	UPC Code
Brushed Black	WA55CG7100AV	887276739137
White	WA55CG7100AW	887276739144

Optional Accessories	Model #	UPC Code
Vent Kit	DV-2A	887276146416

*Requires wireless network, Samsung account and Samsung SmartThings App. The Samsung SmartThings App supports Android OS 4.0 (ICS) or later which is optimized for Samsung smartphones (Galaxy S and Galaxy Note series). This app also supports iOS 7 or later for iPhone models. Samsung SmartThings App available in App Store and Play Store. Only monitoring enabled on Gas Dryers for safety reasons.

**Requires Samsung Smart Washer/Dryer App. The Samsung Smart Washer/Dryer App supports Android OS 2.3.6 or later and iOS 3 or later for iPhone models. Samsung Smart Washer/Dryer App available in App Store and Play Store.

DVE55CG7100

Samsung 7.4 cu. ft. Smart Electric Dryer with Steam Sanitize+

SAMSUNG

Dimensions
Required dimensions for installation:

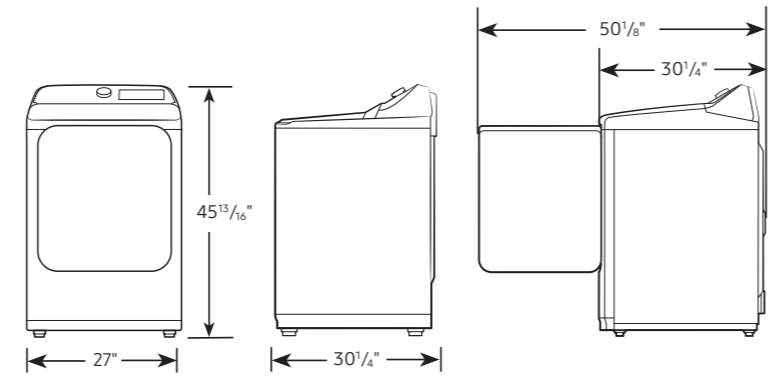

Installation Specifications – Side-by-Side
If the washer and dryer are installed together or the dryer alone, the closet front must have two unobstructed air openings for a combined minimum total area of 72-inch². Your washer alone does not require a specific air opening.

Alcove or closet installation
Minimum clearance for closet and alcove installations:

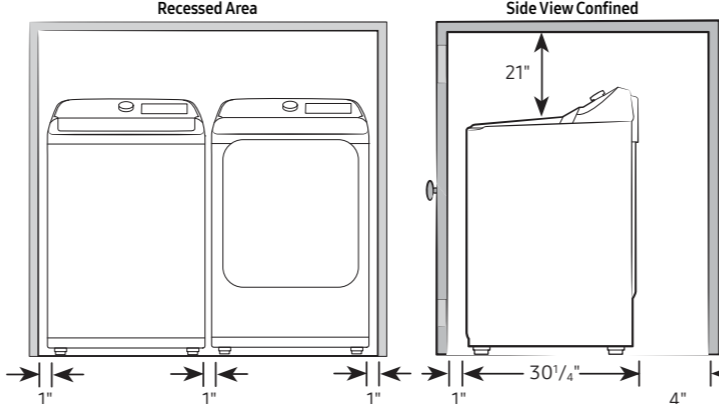

Connection Dimensions
Back and Side View of Electric Dryer

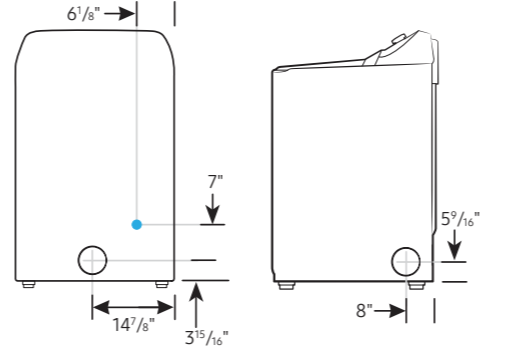

LEGEND:
● Cold Water Connection

Actual color may vary. Design, specifications, and color availability are subject to change without notice. Non-metric weights and measurements are approximate.

©2023 Samsung Electronics America, Inc. 85 Challenger Road, Ridgefield Park, NJ 07660. Tel: 800-SAMSUNG, samsung.com. Samsung is a registered trademark of Samsung Electronics Co., Ltd.

Electric Dryer Spec Sheet - page 1

Electric Dryer Spec Sheet - page 2

DVG55CG7100

Samsung 7.4 cu. ft. Smart Gas Dryer with Steam Sanitize+



SAMSUNG

Available Colors

- Brushed Black
DVG55CG7100V
- White
DVG55CG7100W

Features

- Steam Sanitize+
- Wi-Fi Connectivity with SmartThings*
- Sensor Dry
- Smart Care™
- Interior Drum Light
- Reversible Door
- Accessibility (AUI, Braille)
- Large 7.4 cu. ft. Capacity
- Lint Filter Indicator
- 21 Total Drying Cycles
- 10 Options
- 5 Temperature Settings
- 3-Way Venting (Back, Bottom, Left)

Convenience

- Child Lock
- Lint Filter Indicator

Specifications

12 Preset Drying Cycles:
Refresh, Steam Sanitize+, Normal, Heavy Duty, Permanent Press, Bedding, Delicates, Activewear, Time Dry, Air Fluff, Quick Dry, Downloaded

9 Downloadable Drying Cycles:
Wrinkle Away, Eco Normal, Towels, Wool, Sanitize, Shirts, Denim, Low Temp, Rack Dry

10 Options:
Damp Alert, Wrinkle Prevent, Adjust Time (Up), Adjust Time (Down), Child Lock, Sound On/Off, Eco Dry, Smart Care, Drum Light, Smart Monitor

5 Temperature Settings:
High, Medium High, Medium, Medium Low, Low

5 Dry Levels:
More Dry, Normal-More Dry, Normal Dry, Normal-Less Dry, Less Dry

Warranty
One (1) Year Parts and Labor

Product Dimensions & Weight (WxHxD)
Dimensions: 27" x 45³/₁₆" x 30¹/₄"
Weight: 119.0 lbs

Shipping Dimensions & Weight (WxHxD)
Dimensions: 29¹/₂" x 48⁷/₈" x 31¹/₁₆"
Weight: 127.9 lbs

Gas Dryer	Model #	UPC Code
Brushed Black	DVG55CG7100V	887276740973
White	DVG55CG7100W	887276740980

Electric Dryer	Model #	UPC Code
Brushed Black	DVE55CG7100V	887276740971
White	DVE55CG7100W	887276740928

Matching Washer	Model #	UPC Code
Brushed Black	WA55CG7100AV	887276739137
White	WA55CG7100AW	887276739144

Optional Accessories	Model #	UPC Code
Vent Kit	DV-2A	887276146416
Gas-to-Propane Converter Kit	LPKIT-4	887276352787

*Requires wireless network, Samsung account and Samsung SmartThings App. The Samsung SmartThings App supports Android OS 4.0 (ICS) or later which is optimized for Samsung smartphones (Galaxy S and Galaxy Note series). This app also supports iOS 7 or later for iPhone models. Samsung SmartThings App available in App Store and Play Store. Only monitoring enabled on Gas Dryers for safety reasons.

**Requires Samsung Smart Washer/Dryer App. The Samsung Smart Washer/Dryer App supports Android OS 2.3.6 or later and iOS 3 or later for iPhone models. Samsung Smart Washer/Dryer App available in App Store and Play Store.

Gas Dryer Spec Sheet - page 1

DVG55CG7100

Samsung 7.4 cu. ft. Smart Gas Dryer with Steam Sanitize+

SAMSUNG

Dimensions
Required dimensions for installation:

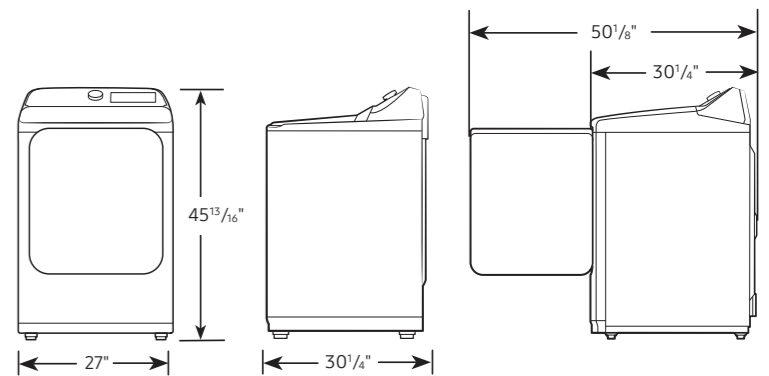

Installation Specifications – Side-by-Side
If the washer and dryer are installed together or the dryer alone, the closet front must have two unobstructed air openings for a combined minimum total area of 72-inch². Your washer alone does not require a specific air opening.

Alcove or closet installation
Minimum clearance for closet and alcove installations:

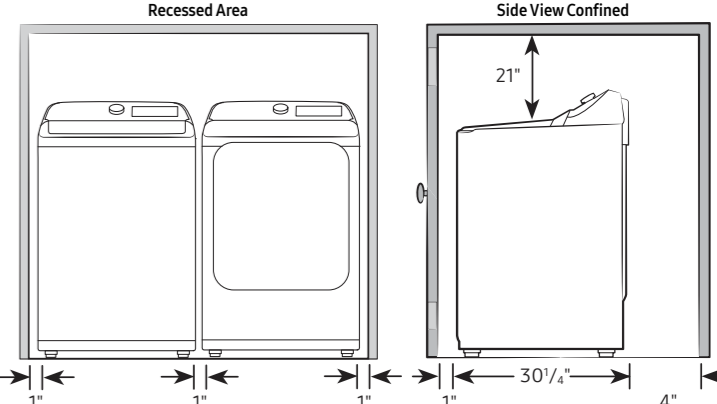

Connection Dimensions
Back and Side View of Gas Dryer

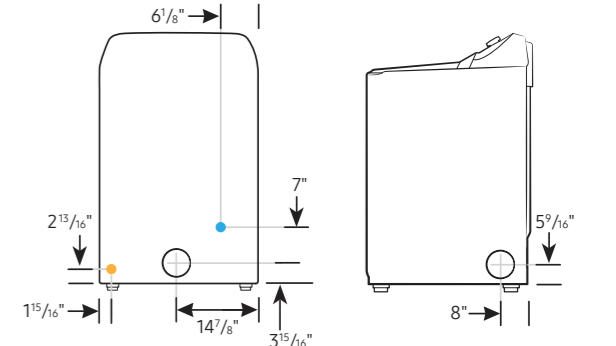

LEGEND:
● Cold Water Connection
● Gas Connection

Actual color may vary. Design, specifications, and color availability are subject to change without notice. Non-metric weights and measurements are approximate.

©2023 Samsung Electronics America, Inc. 85 Challenger Road, Ridgefield Park, NJ 07660. Tel: 800-SAMSUNG, samsung.com. Samsung is a registered trademark of Samsung Electronics Co., Ltd.

Gas Dryer Spec Sheet - page 2

User Manual and Warranty

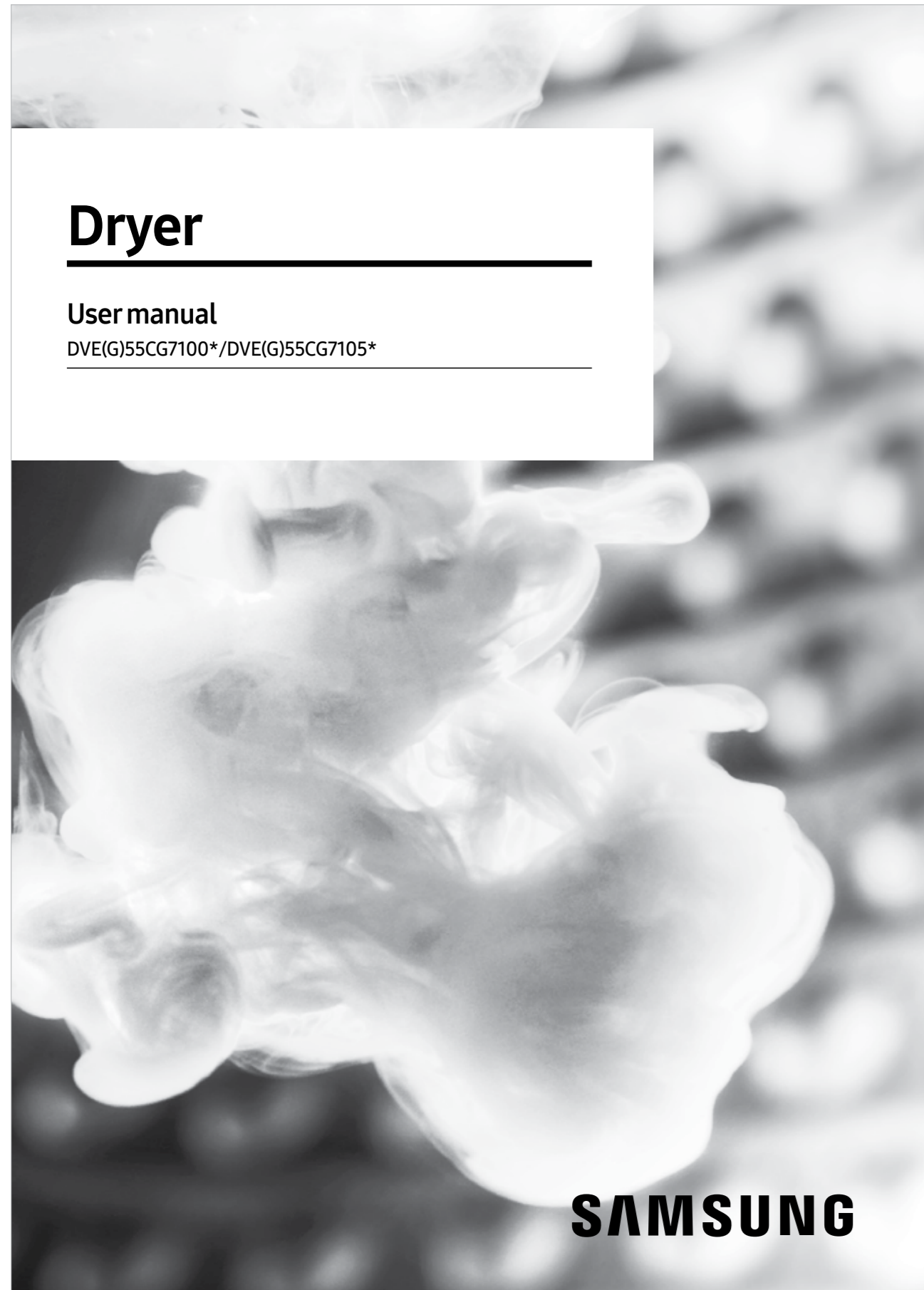

User Manual - Electric and Gas Dryers

LIMITED WARRANTY (U.S.A.) – SAMSUNG DRYER

Models:

DVE(G)55CG7100V

DVE(G)55CG7100W

LIMITED WARRANTY TO ORIGINAL PURCHASER WITH PROOF OF PURCHASE

This SAMSUNG brand product, as supplied and distributed by SAMSUNG ELECTRONICS AMERICA INC. (SAMSUNG) and delivered new, in the original carton to the original consumer purchaser, is warranted by SAMSUNG against manufacturing defects in materials or workmanship for the limited warranty period, starting from the date of original purchase, of:

One (1) Year Parts and Labor

This limited warranty is valid only on products purchased and used in the United States that have been installed, operated, and maintained according to the instructions attached to or furnished with the product. To receive warranty service, the purchaser must contact SAMSUNG at the address or phone number provided below for problem determination and service procedures. Warranty service can only be performed by a SAMSUNG authorized service center. The original dated bill of sale must be presented upon request as proof of purchase to SAMSUNG or SAMSUNG's authorized service center to receive warranty service.

SAMSUNG will provide in-home service within the contiguous United States during the warranty period at no charge, subject to availability of SAMSUNG authorized servicers within the customer's geographic area. If in-home service is not available, SAMSUNG may elect, at its option, to provide transportation of the product to and from an authorized service center. If the product is located in an area where service by a SAMSUNG authorized servicer is not available, you may be responsible for a trip charge or required to bring the product to a SAMSUNG authorized service center for service.

To receive in-home service, product must be unobstructed and accessible to the service agent.

During the applicable warranty period, a product will be repaired, replaced, or the purchase price refunded, at the sole option of SAMSUNG. SAMSUNG may use new or reconditioned parts in repairing a product, or replace the product with a new or reconditioned product. Replacement parts and products are warranted for the remaining portion of the original product's warranty or ninety (90) days, whichever is longer. All replaced parts and products are the property of SAMSUNG and you must return them to SAMSUNG.

Warranty - Electric and Gas Dryers

Feature Icons

DVE55CG7100V / DVG55CG7100V
DVE55CG7100W / DVG55CG7100W

7.4 cu. ft. Smart Electric Dryer with Steam Sanitize+
7.4 cu. ft. Smart Gas Dryer with Steam Sanitize+

Feature Icons

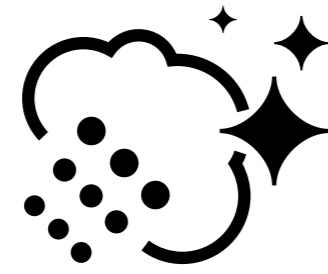

Steam Sanitize+

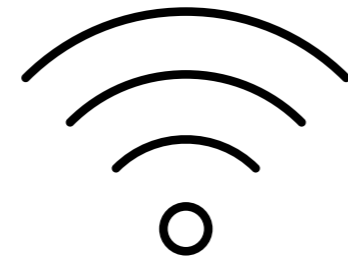

Wi-Fi Connectivity
with SmartThings

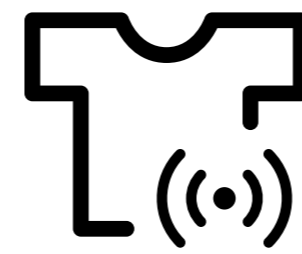

Sensor Dry



Smart Care

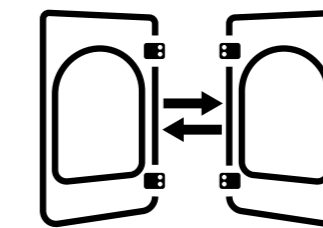

Reversible Dryer Door

Price Tag Guidance

Please follow one of the below naming conventions for price tags at retail, accounting for any potential character count limitations. Please also ensure that any feature list appearing on fact tags follows the Product Messaging hierarchy and copy noted in the Product Guide for each model.

WA55CG7100A*

Long (More than 40 Characters)

5.5 cu. ft. Extra-Large Capacity Smart Top Load Washer with Super Speed Wash (76 characters)

Medium (40 Characters or less)

5.5 cu. ft. TL Washer with Super Speed (39 characters)

Short (30 Characters or less)

5.5 cu. ft. Top Load Washer (28 characters)

WA54CG7105A*

Long (More than 40 Characters)

5.4 cu. ft. Smart Top Load Washer with ActiveWave™ Agitator and Super Speed Wash (94 characters)

Medium (40 Characters or less)

5.4 cu. ft. TL Washer with Super Speed (38 characters)

Short (30 Characters or less)

5.4 cu. ft. Top Load Washer (28 characters)

DVE55CG7100*

Long (More than 40 Characters)

7.4 cu. ft. Smart Electric Dryer with Steam Sanitize+ (53 characters)

Medium (40 Characters or less)

7.4 cu. ft. Electric Dryer (26 characters)

Short (30 Characters or less)

7.4 cu. ft. Electric Dryer (26 characters)

DVG55CG7100*

Long (More than 40 Characters)

7.4 cu. ft. Smart Gas Dryer with Steam Sanitize+ (48 characters)

Medium (40 Characters or less)

7.4 cu. ft. Gas Dryer (21 characters)

Short (30 Characters or less)

7.4 cu. ft. Gas Dryer (21 characters)

SAMSUNG