



ASSEMBLY INSTRUCTIONS COASTER FINE FURNITURE



Fine Furniture for every stage of life

2253K Futon Bunk Bed

REVISION 0 : 05/30/2019
REVISION 1 : 10/21/2019

ASSEMBLY INSTRUCTIONS

ASSEMBLY TIPS:

1. Remove hardware from box and sort by size.
2. Please check to see that all hardware and parts are present prior to start of assembly.
3. Please follow attached instructions in the same sequence as numbered to assure fast & easy assembly.



WARNING!









1. Don't attempt to repair or modify parts that are broken or defective. Please contact the store immediately.
2. This product is for home use only and not intended for commercial establishments.



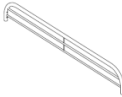







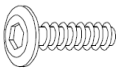

ASSEMBLY TIME

45 MINUTES

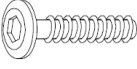
PARTS IDENTIFICATION

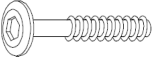
<p>A RIGHT HEADBOARD</p>		<p>1PC</p>		<p>F BED SUPPORT</p>		<p>2PC</p>
<p>B LEFT HEADBOARD</p>		<p>1PC</p>		<p>G SAFETY RAIL</p>		<p>2PC</p>
<p>C TOP BEDBASE</p>		<p>1PC</p>		<p>H RIGHT JOINT</p>		<p>1PC</p>
<p>D LOWER FRONT BEDBASE</p>		<p>1PC</p>		<p>I LEFT JOINT</p>		<p>1PC</p>
<p>E LOWER BACK BEDBASE</p>		<p>1PC</p>		<p>J HOOK</p>		<p>1PC</p>

HARDWARE IDENTIFICATION

<p>1 BOLT (1/4X10mm)</p>		<p>8PCS</p>		<p>7 NUT 5/16</p>		<p>12PCS</p>
<p>2 BOLT (5/16X32mm)</p>		<p>4PCS</p>		<p>8 PVC STICKER</p>		<p>4PCS</p>
<p>3 BOLT (5/16X45mm)</p>		<p>8PCS</p>		<p>9 ALLEN KEY 4mm</p>		<p>1PC</p>
<p>4 BOLT (5/16X53mm)</p>		<p>8PCS</p>		<p>10 ALLEN KEY 5mm</p>		<p>1PC</p>
<p>5 WASHER 8.5mm</p>		<p>20PCS</p>		<p>11 WRENCH 13mm</p>		<p>1PC</p>
<p>6 WASHER 8.5mm</p>		<p>12PCS</p>				

NOTE:

Phillips head screw driver is required in the assembly process; however, manufacturer does not provide this item.

ITEM: **2253K**



ASSEMBLY INSTRUCTIONS

STEP 1

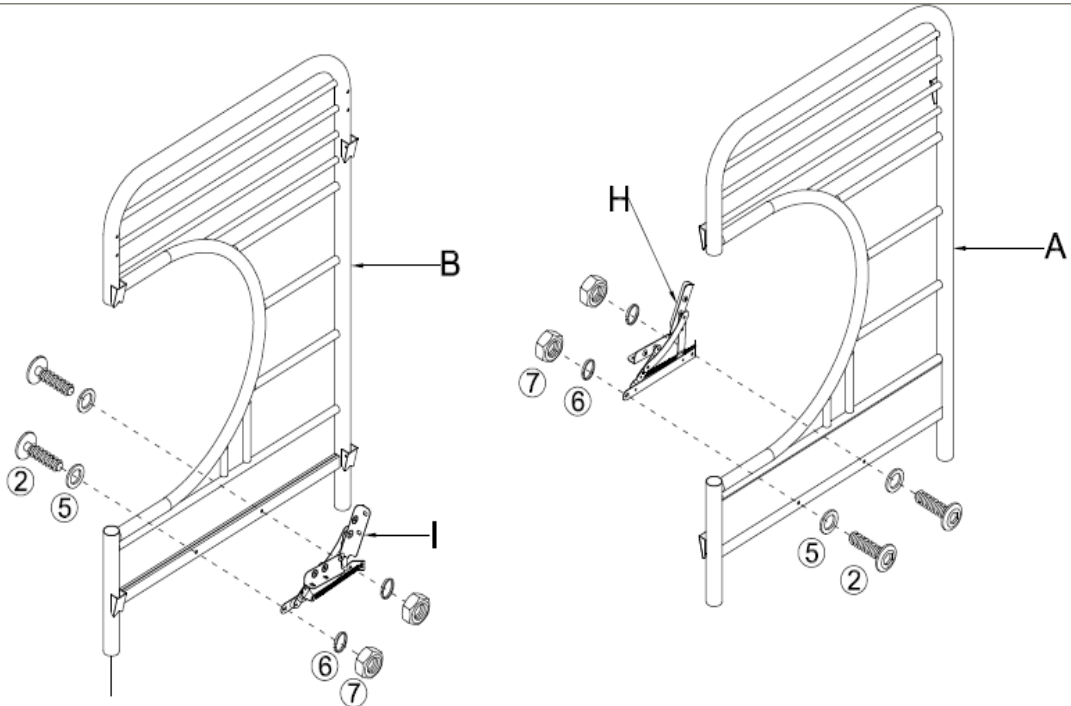

 5/16" x 32mm ② x 4	 ø8.5 ⑤ x 4	 ø8.5 ⑥ x 4	 5/16" ⑦ x 4
---------------------------	-------------------	-------------------	--------------------

STEP 2

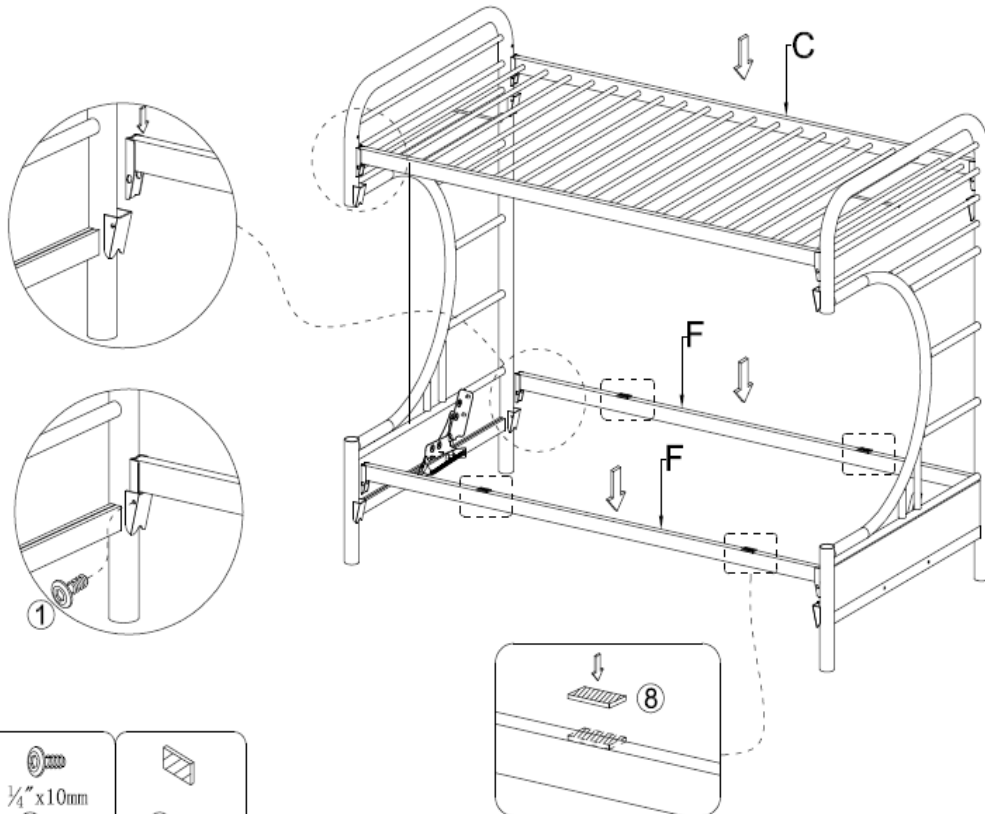

 1/4" x 10mm ① x 8	 ⑧ x 4
--------------------------	-----------

ITEM: **2253K**



ASSEMBLY INSTRUCTIONS

STEP 3

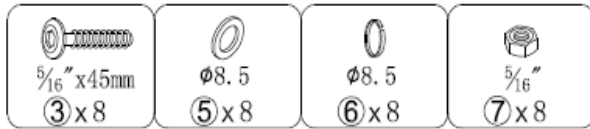
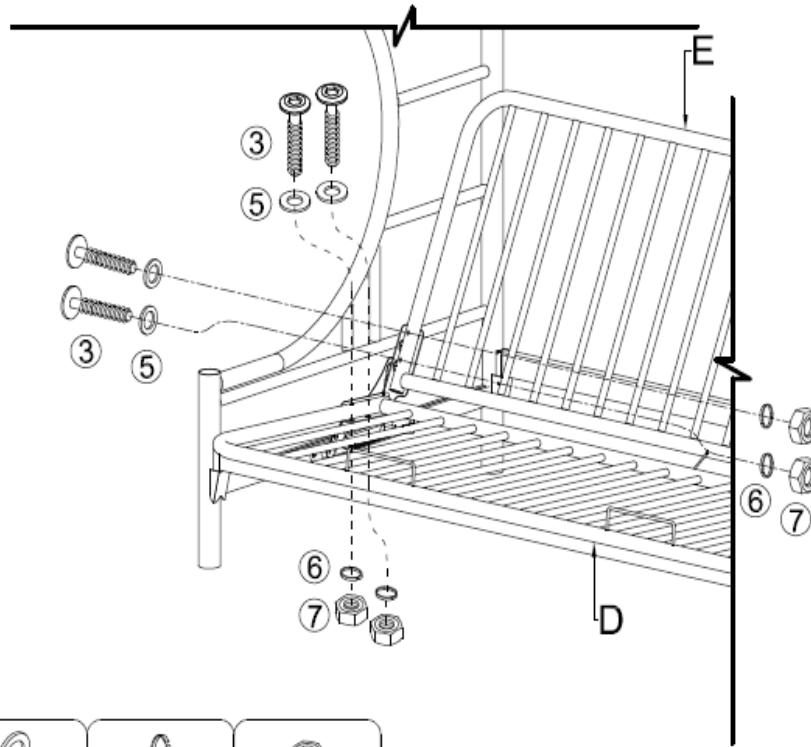

STEP 4 COMPLETE

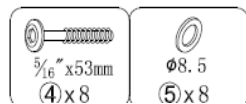
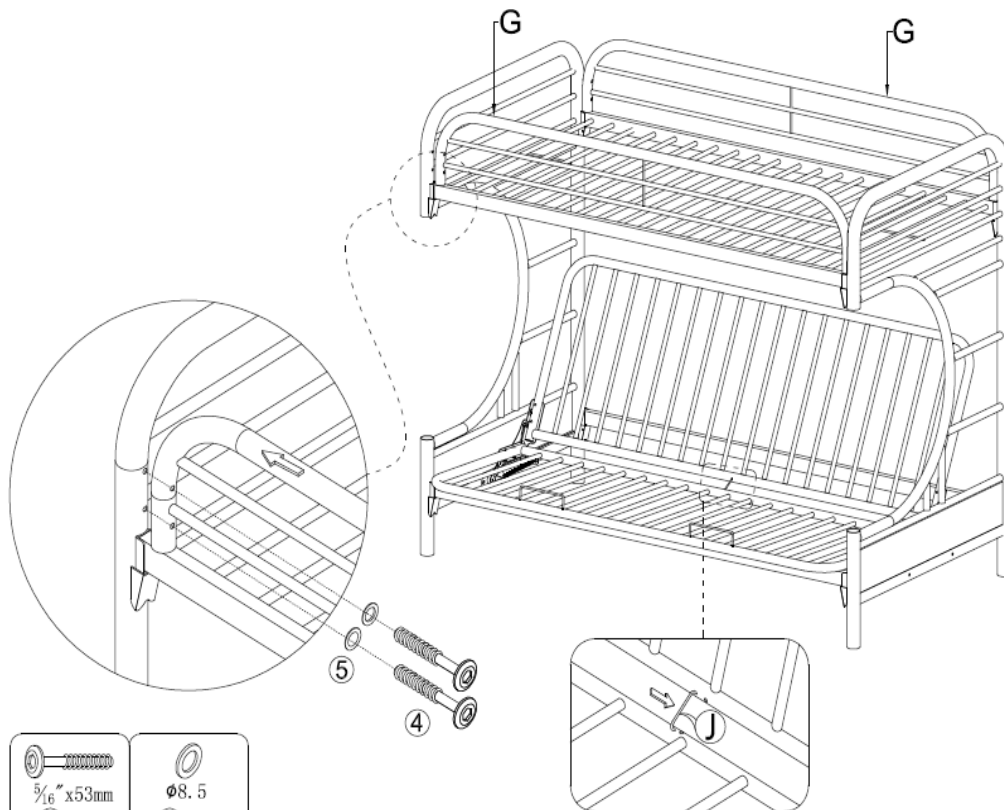

ITEM: **2253K**



ASSEMBLY INSTRUCTIONS

COASTER CO. SANTA FE SPRINGS, CA. 90670
INSTRUCTIONS FOR BUNK BED MODEL # 2253K

SIZE OF MATTRESS

The length and width of the bunk mattress are as follow:

	Length	Width	Thickness
Upper bunk	74" - 75"	37 1/2" - 38 1/2"	6" Maximum

Ensure thickness of mattress does not exceed 6" and there must be at least 5" from mattress sleeping surface to top edge of guardrail.

SAFETY WARNING

1. Follow the information on the warnings appearing on the upper bunk end structure and on the carton. Do not remove the warning label from bed.
 2. Always use the recommended size mattress or mattress support or both to help prevent the likelihood of entrapment or falls.
 3. Surface of mattress must be at least 5 in. (127 mm) below the upper edge of guardrails.
 4. Do not allow children under 6 years of age to use the upper bunk.
 5. Prohibit more than one person on upper bunk.
 6. Periodically check and ensure that the guardrail, ladder, and other components are in their proper position, free from damage, and that all connectors are tight.
 7. Do not allow horseplay on or under the bed and prohibit jumping on the bed.
 8. Always use the ladder for entering and leaving the upper bunk.
 9. Do not use substitute parts. Contact the manufacturer or dealer for replacement parts.
 10. Use of a night light may provide added safety precaution for a child using upper bunk.
 11. Always use guardrails on both long sides of the upper bunk. If the bunk bed will be placed next to the wall, the guardrail that runs the full length of the bed should be placed against the wall to prevent entrapment between the bed and wall.
 12. The use of water or sleep flotation mattress is prohibited.
 13. Keep these instructions for future reference.
- STRANGULATION HAZARD:**
14. Never attach or hang items to any part of the bunk bed that are not designed for use with the bed for example, but not limited to hooks, belts, and jump ropes.

REPLACEMENT PARTS:

Replacement parts, including additional guardrails may be obtained from any

ITEM: **2253K**



PRODUCT DIMENSION:

