

ASSEMBLY INSTRUCTIONS
COASTER FINE FURNITURE



Fine Furniture for every stage of life

907516
Accent Bench

ITEM:907516



ASSEMBLY INSTRUCTIONS

ASSEMBLY TIPS:

1. Remove hardware from box and sort by size.
2. Please check to see that all hardware and parts are present prior to start of assembly.
3. Please follow attached instructions in the same sequence as numbered to assure fast & easy assembly.



WARNING!

1. Don't attempt to repair or modify parts that are broken or defective. Please contact the store immediately.
2. This product is for home use only and not intended for commercial establishments.





ASSEMBLY TIME

10 MINUTES

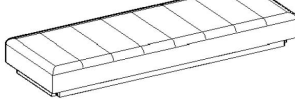
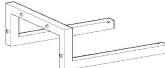
PARTS IDENTIFICATION

A	SEAT CUSHION WITH FRAME		1PC
B	LEG		2PCS

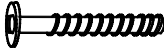
HARDWARE IDENTIFICATION

1	ALLEN WRENCH (M5 x 57mm - BLK)		1PC
2	BOLT (M8 x 60mm - BLK)		4PCS
3	LOCK WASHER (M8 - BLK)		4PCS
4	FLAT WASHER (M8 - BLK)		4PCS

ITEM: **907516**

ASSEMBLY INSTRUCTIONS



STEP 1

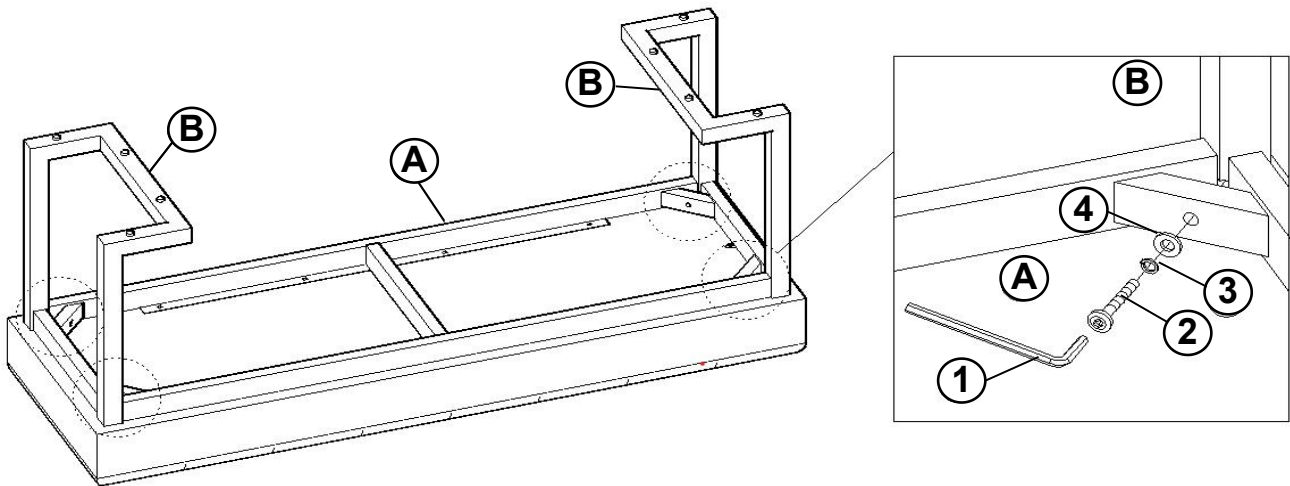

STEP 2
COMPLETE

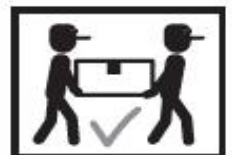
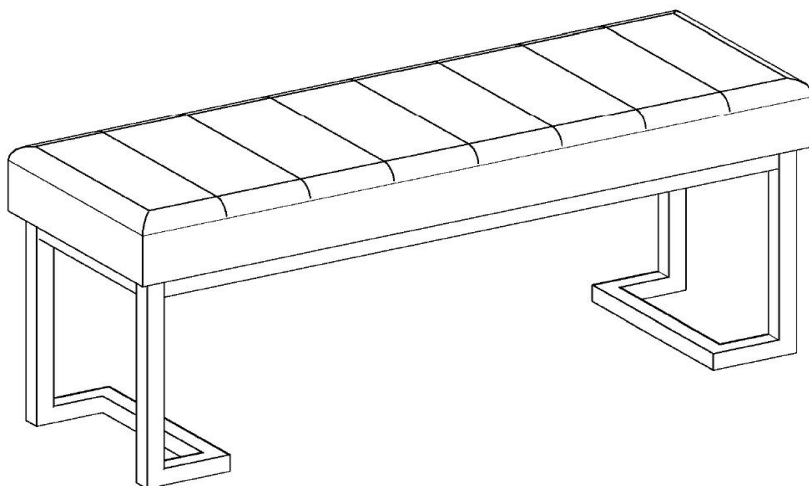

ITEM:907516

COASTER
FINE FURNITURE

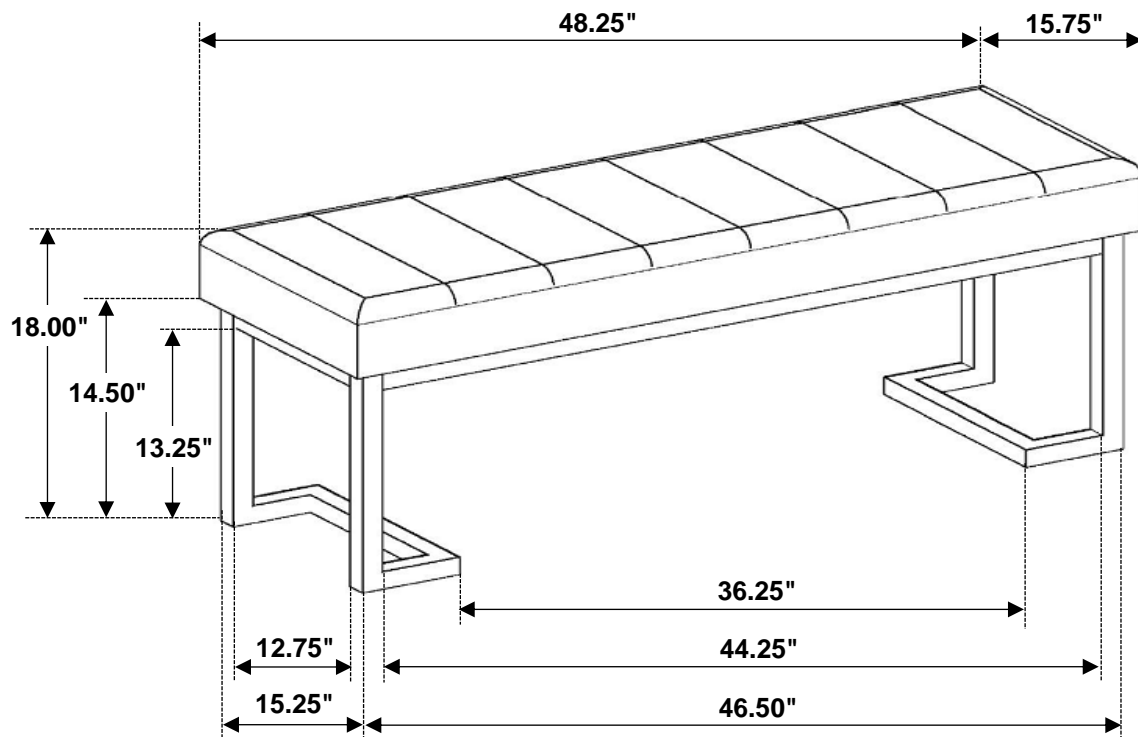

Note: Dimension tolerance $\pm 5\%$