

dji OSMO MOBILE 7 / 7P

User Manual

v1.0 2025.02

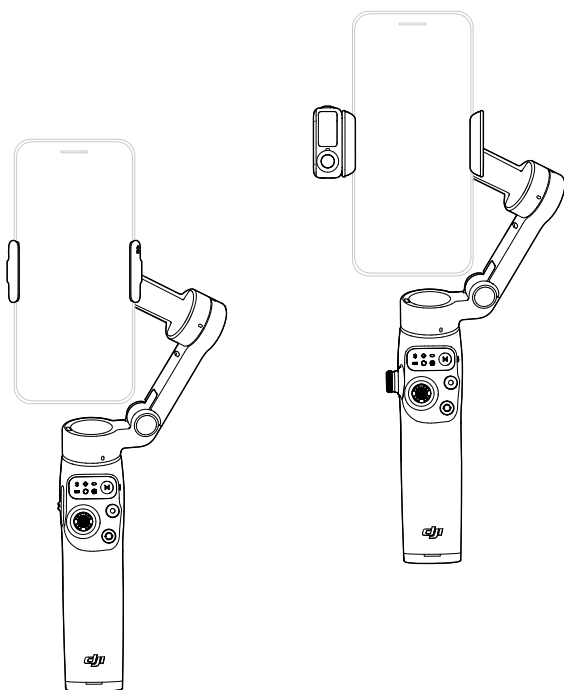



This document is copyrighted by DJI with all rights reserved. Unless otherwise authorized by DJI, you are not eligible to use or allow others to use the document or any part of the document by reproducing, transferring or selling the document. Only refer to this document and the content thereof as instructions to operate DJI products. The document should not be used for other purposes.

In the event of divergence among different versions, the English version shall prevail.

Searching for Keywords

Search for keywords such as “battery” and “install” to find a topic. If you are using Adobe Acrobat Reader to read this document, press Ctrl+F on Windows or Command+F on Mac to begin a search.

Navigating to a Topic

View a complete list of topics in the table of contents. Click on a topic to navigate to that section.

Printing this Document

This document supports high resolution printing.

Using this Manual

Legend

△ Important

💡 Hints and Tips

📖 Reference

Read Before Use

DJI™ provides you with tutorial videos and the following documents:

1. *Safety Guidelines*
2. *Quick Start Guide*
3. *User Manual*

It is recommended to watch all the tutorial videos and read the *Safety Guidelines* before using for the first time. Make sure to review the *Quick Start Guide* before using for the first time and refer to this *User Manual* for more information.

Video Tutorials

Go to the address below or scan the QR code to watch the tutorial videos, which demonstrate how to use the product safely:



<https://www.dji.com/osmo-mobile-7-series/video>

Illustration

The general descriptions in this manual apply to both Osmo Mobile 7 and Osmo Mobile 7P. Osmo Mobile 7P is used as an example in the illustrations.

Contents

Using this Manual	3
Legend	3
Read Before Use	3
Video Tutorials	3
Illustration	3
1 Product Profile	6
1.1 Osmo Mobile 7	6
1.2 Osmo Mobile 7P	7
1.3 Multifunctional Module	8
2 Using for the First Time	9
2.1 Charging	9
2.2 Unfolding	9
2.3 Attaching the Phone	10
2.4 Connecting to the DJI Mimo App	11
2.5 Firmware Update	12
3 Basic Features	13
3.1 Grip Gestures	13
3.2 Follow Modes	14
3.3 Indicators	15
3.4 Buttons and Ports	16
3.5 Phone Charging	18
3.6 Storage	19
4 Advanced Features	20
4.1 Multifunctional Module	20
Installing and Removing	20
Tracking and Shooting	21
Tracking	22
Shooting	23
Fill Light	24
Connecting to Wireless Microphones	25
Phone Charging	27
Indicators	27
Firmware Update	28
4.2 Remote Control With Watch	28
5 Maintenance	29

6	Appendix	30
6.1	Specifications	30
6.2	Phone Compatibility	30

1 Product Profile

1.1 Osmo Mobile 7

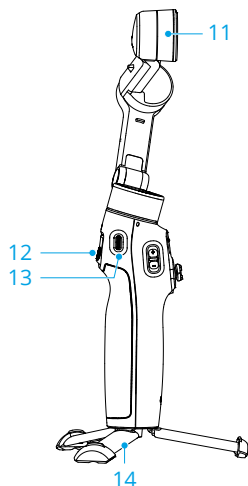
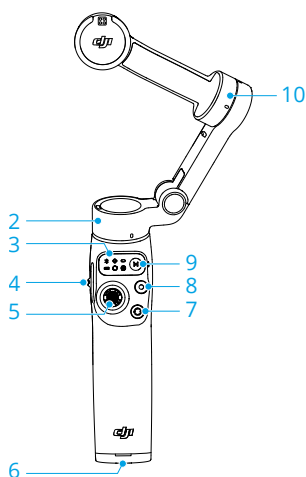
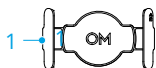

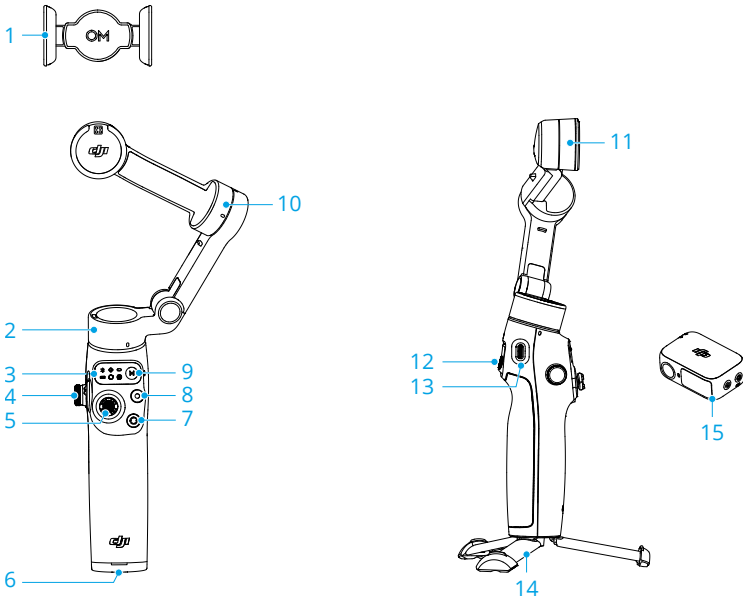

1. DJI OM Magnetic Phone Clamp 4
2. Pan Motor
3. Status Panel
4. Zoom Slider
5. Joystick
6. 1/4"-20 UNC Port
7. Switch Button
8. Shutter/Record Button
9. Power/M Button
10. Tilt Motor
11. Roll Motor
12. Trigger
13. Charging Port (USB-C)
14. Built-in Tripod

1.2 Osmo Mobile 7P



- | | |
|-----------------------------------------|-----------------------------------|
| 1. DJI OM 7 Series Magnetic Phone Clamp | 8. Shutter/Record Button |
| 2. Pan Motor | 9. Power/M Button |
| 3. Status Panel | 10. Tilt Motor |
| 4. Side Wheel | 11. Roll Motor |
| 5. Joystick | 12. Trigger |
| 6. 1/4"-20 UNC Port | 13. Charging Port (USB-C) |
| 7. Switch Button | 14. Built-in Tripod |
| | 15. DJI OM Multifunctional Module |

 • DJI OM Multifunctional Module is hereinafter referred to as “Multifunctional Module”.

 • The Osmo Mobile 7P combo includes Multifunctional Module and accompanying accessories. For Osmo Mobile 7, the module and accessories are sold separately.

1.3 Multifunctional Module

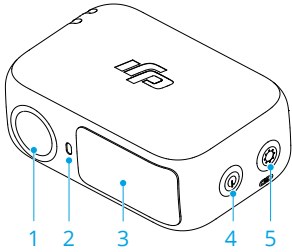

1. Tracking Camera
2. Camera Status Indicator
3. Fill Light
4. Brightness Control Button
5. Color Temperature Control/Bluetooth Pairing Button

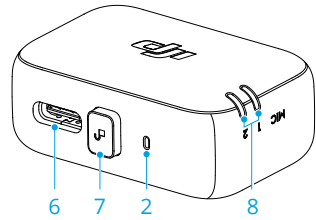

6. Audio Data/Phone Charging Port (USB-C)
7. Release Button
8. Wireless Microphone Status Indicator

2 Using for the First Time

2.1 Charging

The product is fully charged when the Battery Level Indicator turns off.

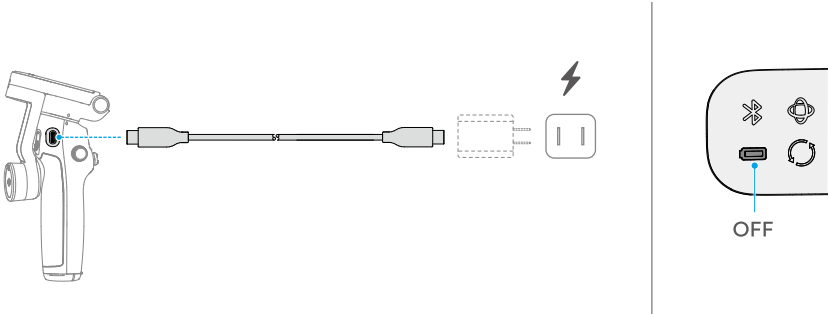

2.2 Unfolding

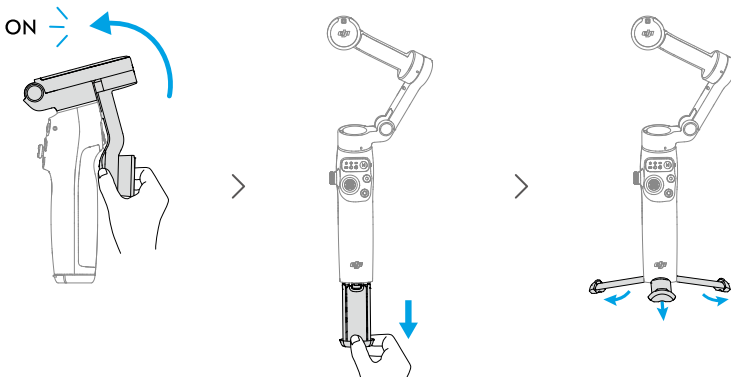

- The built-in tripod is suitable for stable, level surfaces in windless environments. In other conditions, it is recommended to attach DJI OM Grip Tripod (sold separately) to the bottom of the gimbal.
- Only Osmo Mobile 7P has a built-in extension rod.

If you extend the built-in extension rod, make sure to adjust the Pan Motor to be level with the ground. This ensures balance after the phone is attached to the gimbal.

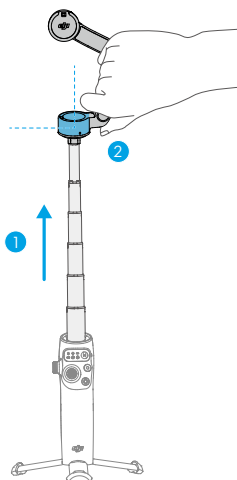

2.3 Attaching the Phone

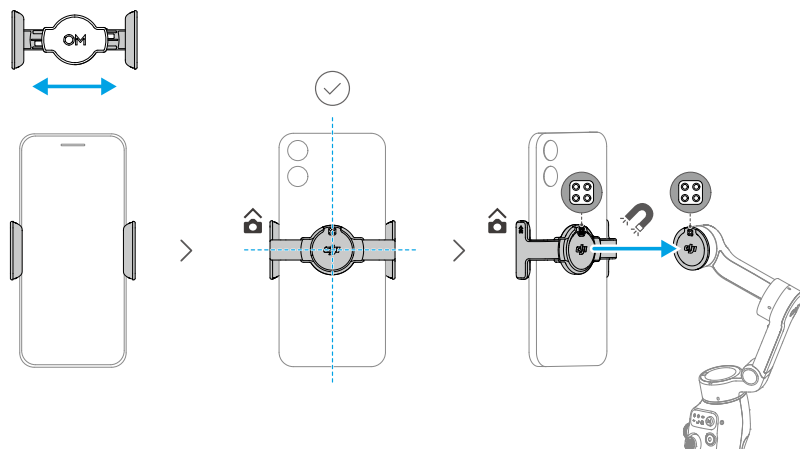

A steady gimbal mode light (☉ / ○ / ● / ◌) indicates that the gimbal is stabilizing the phone. If the light is not displayed after you attach the phone, press the M button to enable stabilization.

2.4 Connecting to the DJI Mimo App

1. Scan the QR code to download DJI Mimo.



2. Enable Bluetooth on your phone, open DJI Mimo, and connect to the gimbal.

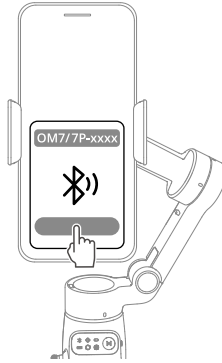

-
- To check the Android and iOS operating system versions supported by DJI Mimo, visit <https://www.dji.com/downloads/djiapp/dji-mimo>.
 - The interface and functions of DJI Mimo may vary as the software version is updated. Actual user experience is based on the software version used.

💡 If Bluetooth connection fails, try the following steps:

1. Go to Bluetooth settings on your phone. Remove any existing connections with the gimbal and forget the device.
 2. [Reset Bluetooth for the gimbal](#).
 3. Tap the new device name in Bluetooth settings. Once connected, relaunch DJI Mimo.
-

2.5 Firmware Update

A prompt will appear in DJI Mimo when new firmware is available. Tap the prompt and follow the on-screen instructions to update the firmware.

Ensure that the Battery Level Indicator shows solid green before the update. **DO NOT** exit DJI Mimo during the update.

If the update fails, restart DJI Mimo, reestablish the Bluetooth connection, and retry.

3 Basic Features



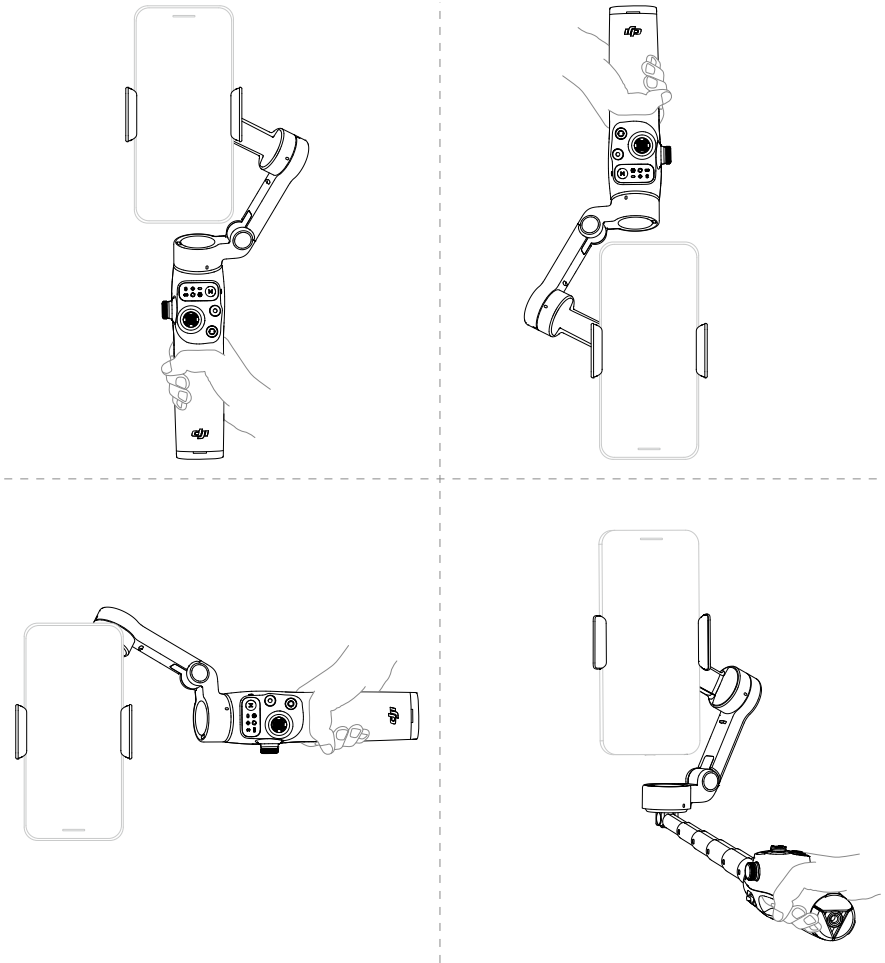

3.1 Grip Gestures



- Grip gestures apply to both landscape and portrait orientations.
- Only Osmo Mobile 7P has a built-in extension rod.
- If the built-in tripod is extended, grip the handle to ensure stability. **DO NOT** grip only the tripod.

3.2 Follow Modes

Click to watch the [tutorial videos](#).

Follow mode	Effect
PTF (Pan and tilt follow) 	①+②
PF (Pan follow) 	①
FPV (Pan, tilt, and roll follow) 	①+②+③
SpinShot 	①+②+③+④
Lock	The phone does not follow handle movements



① Rotate the handle in the horizontal plane and the phone follows

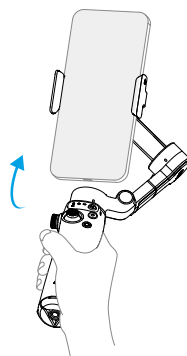

② Swing the handle back and forth and the phone follows

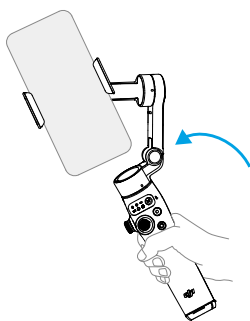

③ Rotate the handle in the vertical plane and the phone follows

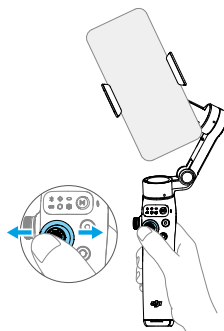

④ Move the joystick left or right to rotate the phone in the vertical plane

3.3 Indicators

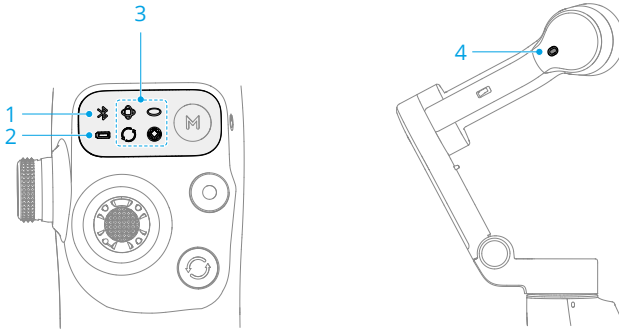

1. System Status Indicator

	Pulses green	Bluetooth disconnected
	Solid green	Bluetooth connected

2. Battery Level Indicator

	Blinks red quickly	≤5%
	Solid red	6%-19%
	Solid yellow	20%-60%
	Solid green	>60%

3. Gimbal Mode Indicator

	On	PTF
	On	PF
	On	FPV
	On	SpinShot
	Blinks alternately	Firmware updating
	Blinks simultaneously	Firmware update failed or abnormal status

4. Recording Status Indicator

	Solid red	Recording video using DJI Mimo
--	-----------	--------------------------------

3.4 Buttons and Ports

The following features are based on DJI Mimo. Support for certain features in the system camera may vary depending on the phone model. For more information, visit <https://www.dji.com/osmo-mobile-7-series>.

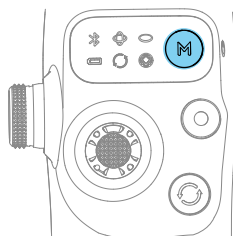

Power/M Button

When powered off

With the gimbal folded, press once: Check the battery level

With the gimbal unfolded, press once: Power on

When powered on

Press once: Switch between gimbal modes

Press three times: Enter standby mode (press any button to exit)

Press and hold: Power off

- * The M button can also control phone charging using the gimbal or Multifunctional Module.

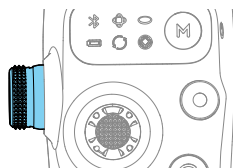

Side Wheel (Osmo Mobile 7P)

Press once: Switch between focus and zoom

Rotate: Control focus or zoom

- * The side wheel can [control the fill light](#) when used with Multifunctional Module.

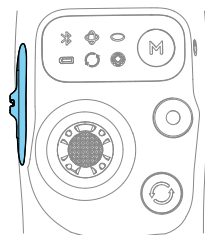

Zoom Slider (Osmo Mobile 7)

Push once: Switch between preset zoom levels

Push continuously: Change zoom continuously

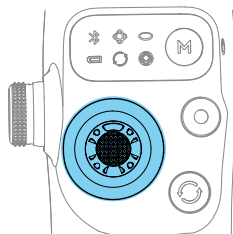

Joystick

Move vertically and horizontally to tilt and pan the mobile phone. The joystick control direction can be set in DJI Mimo.

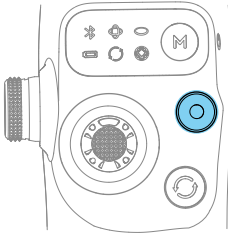

Shutter/Record Button

Press once: Take a photo or start/stop recording
Press twice: Take a photo during recording
Press and hold: Burst shooting when in photo mode

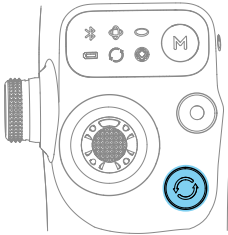

Switch Button

Press once: Switch between front and rear cameras
Press twice: Switch between landscape and portrait modes
Press three times: Switch between photo and video modes

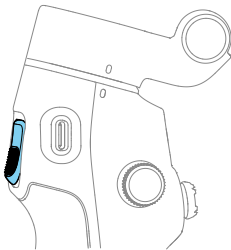

Trigger

Press once: Start or stop ActiveTrack
Press twice: Recenter the gimbal
Press three times: Rotate the phone 180 degrees in the horizontal plane
Press once, and then press and hold: Adjust the follow speed to fast mode. Release to exit.
Press and hold: Enter lock mode. Release to exit.

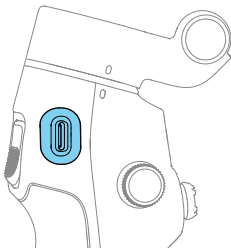

Charging Port (USB-C)

Charging the gimbal
[Charging the phone](#)

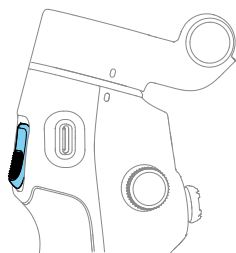

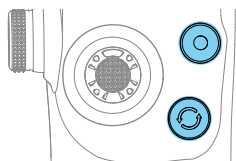

Combination Operation

Press the switch button, shutter/record button, and trigger simultaneously for more than one second to reset the Bluetooth name and connection and reconnect.



3.5 Phone Charging

- Make sure that the gimbal is sufficiently charged (the indicator shows  or ).
- Make sure that the gimbal is powered off.
- Certain phones are charged only after pressing the M button.

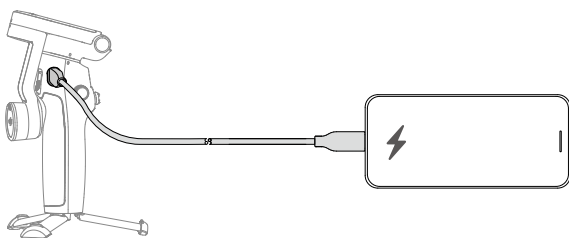

3.6 Storage

- For Osmo Mobile 7P, retract the extension rod before performing the following steps.
- When the gimbal powers off, it automatically rotates to the folding position. Remove the phone, phone clamp, and Multifunctional Module together. For the next use, attach them as a whole and unfold the gimbal to start shooting.

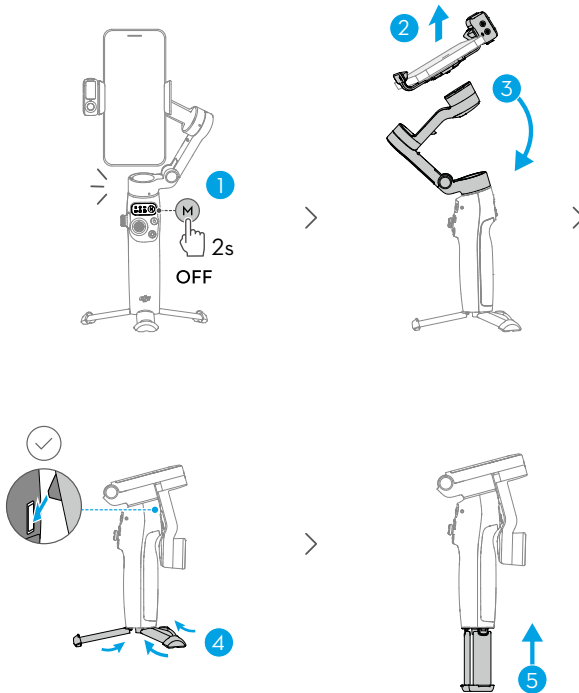

4 Advanced Features

4.1 Multifunctional Module

- 💡 • The Osmo Mobile 7P combo includes Multifunctional Module and accompanying accessories. For Osmo Mobile 7, the module and accessories are sold separately.
-

Installing and Removing

Example ①
Capture photos or videos of yourself

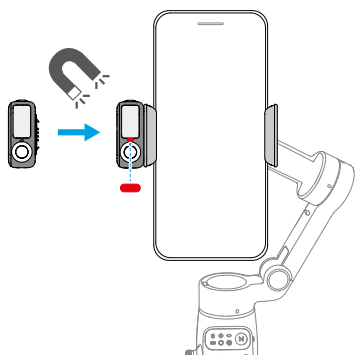

Example ②
Capture photos or videos of others

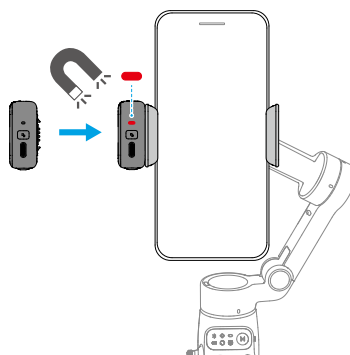

- 💡 • If the indicator shown in the preceding figure does not turn on after Multifunctional Module is installed, check whether the marks on the gimbal and the phone clamp are aligned.
 - If Multifunctional Module is idle for more than five minutes, it automatically enters sleep mode and the indicator turns off. To exit sleep mode, press the trigger on the gimbal.
-

Avoid blocking the rear camera when shooting in landscape mode.

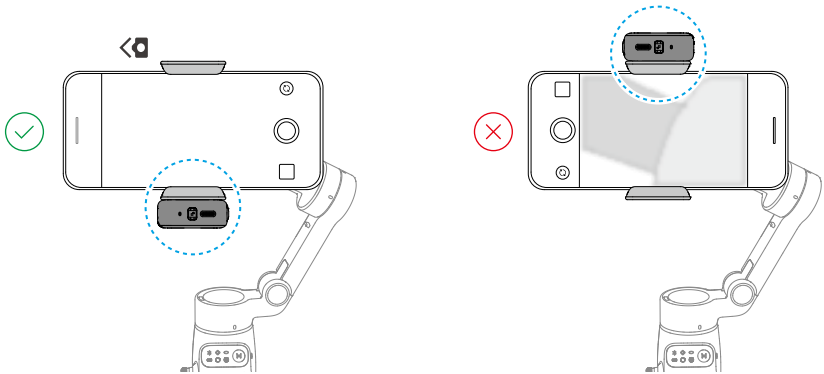

Remove Multifunctional Module:

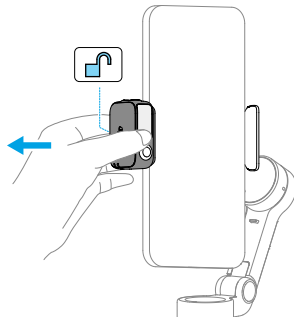

Tracking and Shooting

Multifunctional Module allows you to enable tracking in the system camera and third-party camera apps, without the need to use DJI Mimo.

-
- ⚠ • Multifunctional Module supports tracking people only.
 - The tracking and shooting features of Multifunctional Module are disabled in DJI Mimo.
-
- 💡 • Position the tracking camera of Multifunctional Module and the phone camera towards the subject. For example, both cameras are used to take selfies in the following illustrations.

- To achieve optimal gesture recognition, keep the subject 0.5m to 3m away from the tracking camera.
 - During tracking, keep the subject 0.5m to 8m away from the tracking camera.
-

Tracking

1. Enable Bluetooth on the phone and connect to the gimbal.

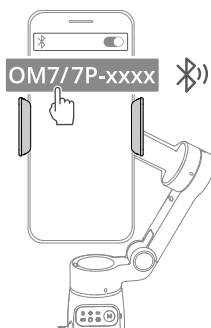

2. Enable tracking: Show the  gesture to the camera or press the trigger. The indicator turns solid green.

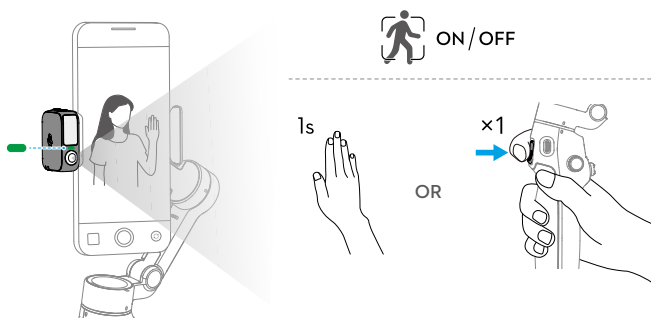

3. Adjust the composition as needed during tracking.

- Method 1: Use the joystick.
- Method 2: Use hand gestures.

Show the  gesture to the camera. The indicator turns solid yellow and tracking is automatically paused. The subject can move to the desired position in the frame.

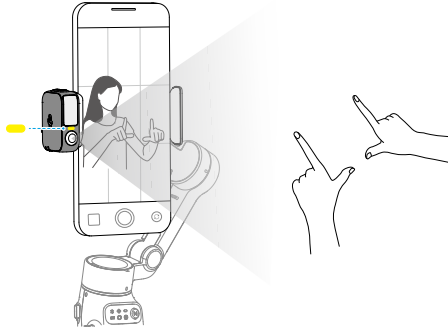

Show the  gesture again to confirm the composition. The indicator turns solid green and tracking automatically resumes.

To restore the default composition for each method, press the trigger twice.

4. Stop tracking: Show the  gesture or press the trigger again. The indicator turns solid red.

Shooting

Whether tracking is enabled or not, you can use the  gesture to start a countdown for taking a photo or starting/stopping recording. The indicator pulses yellow during the countdown.

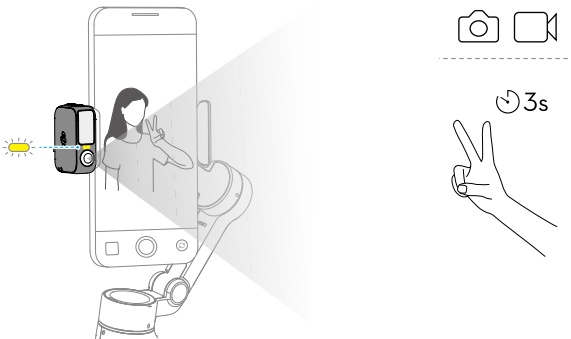

Fill Light

Make sure that Multifunctional Module is [properly installed](#).

Adjust brightness:



Adjust color temperature:

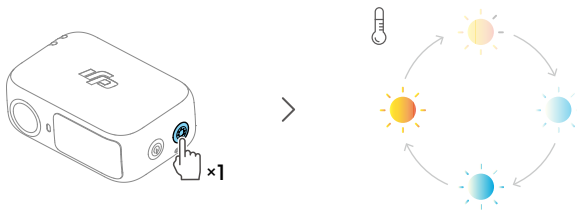

Osmo Mobile 7P allows you to control the fill light on Multifunctional Module using the side wheel:

- Press and hold: Turn on/off the fill light
- Rotate: Adjust brightness or color temperature

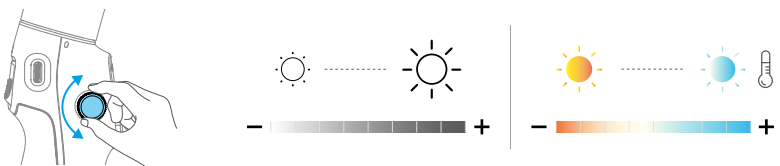

- Press once: Switch between controlling brightness and color temperature
- Press twice in DJI Mimo: Set the effect of rotating the side wheel to focus/zoom control or brightness/color temperature control

Connecting to Wireless Microphones

Multifunctional Module can connect to two wireless microphone transmitters (hereinafter referred to as “transmitters”). Supported transmitters:

- DJI Mic Mini

1. Connect Multifunctional Module to the phone.

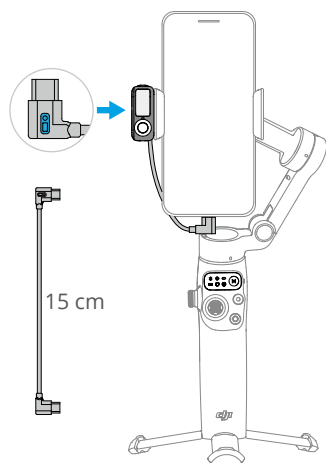

2. Enable Bluetooth pairing for Multifunctional Module.

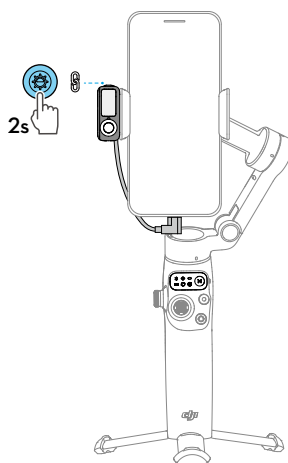

3. Power on the transmitter.

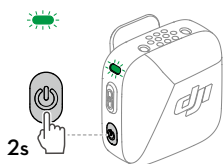

4. Enable Bluetooth pairing for the transmitter.

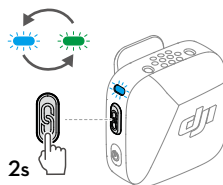



5. Once paired, both indicators of Multifunctional Module and the transmitter turn solid green. You can start recording.



- To prevent the cable connecting Multifunctional Module and the phone from obstructing the gimbal, bend the cable as needed.
- For iPhone 14 and earlier models, a USB-C to Lightning cable (sold separately) is required to connect to Multifunctional Module.

- You can configure wireless microphone settings in DJI Mimo.

Phone Charging

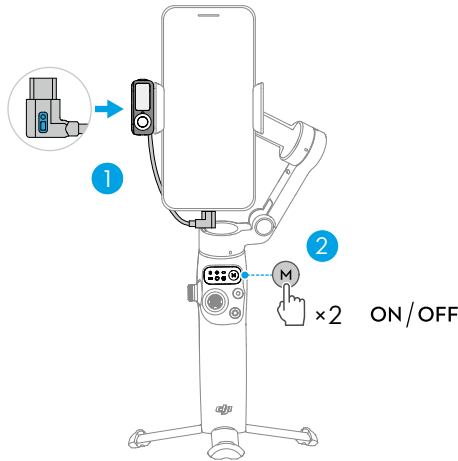

- Make sure that the gimbal is sufficiently charged (the indicator shows  or ).



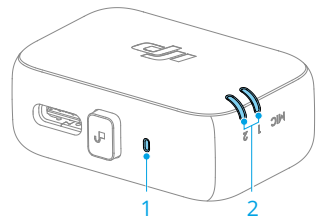
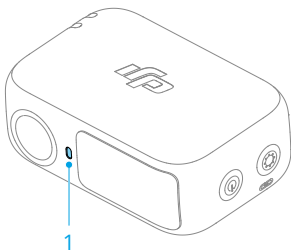





Indicators



1. Camera Status Indicator

 —	Solid red	Tracking disabled or subject lost
 —	Solid green	Subject being tracked
	Blinks green	Subject lost temporarily

	Solid yellow	Composition being adjusted
	Blinks yellow	Countdown for photo shooting or video recording
2. Wireless Microphone Status Indicator		
	Blinks green quickly	Multifunctional Module pairing with a transmitter
	Blinks green slowly	Multifunctional Module paired with a transmitter but not connected to the phone using the cable
	Solid green	Ready for audio recording
	Solid red	Battery less than 10% for the paired transmitter
	Solid yellow	Noise cancelling enabled for the paired transmitter

Firmware Update

Make sure that Multifunctional Module is [properly installed](#).

When using DJI Mimo to update the gimbal firmware, the module firmware is updated together. Please wait for the upgrade to complete.

4.2 Remote Control With Watch

You can use DJI Mimo on an Apple Watch to view the camera feed, control the gimbal, and enable ActiveTrack remotely.

1. Pair the watch with your phone and install DJI Mimo on both devices.
2. Run DJI Mimo on the phone, connect to the gimbal, and enter the camera view.
3. Run DJI Mimo on the watch to start remote control.

-
-  • Keep the devices within the Bluetooth range.
 - To view the supported watch devices, visit <https://www.dji.com/osmo-mobile-7-series/faq>.
-

5 Maintenance



- Put out any product fire using water, sand, fire blanket, or a dry powder fire extinguisher.
 - Never disassemble or pierce the product in any way or the battery may leak, catch fire, or explode.
-



- It is recommended to use a soft, dry cloth to clean the product.
- When the phone is attached to the gimbal, the compass feature of the phone may experience interference. In such cases, calibrate the compass according to the prompts in the phone.
- The NFC (near-field communication) and wireless charging functions of the phone may be affected when the phone clamp is attached. These functions will no longer be affected once the phone clamp has been removed from the phone.
- The built-in extension rod contains a spring. If the extension rod is extended for more than a week, the spring may become deformed and the extension rod can no longer be used normally. It is recommended to retract the extension rod and fold the gimbal after use.

* Only Osmo Mobile 7P has a built-in extension rod.

6 Appendix

6.1 Specifications

Visit <https://www.dji.com/osmo-mobile-7-series/specs> for more information.

6.2 Phone Compatibility

Visit <https://www.dji.com/osmo-mobile-7-series> for more information.



Osmo Mobile 7
Contact
DJI SUPPORT



Osmo Mobile 7P
Contact
DJI SUPPORT

This content is subject to change without notice.
Download the latest version from



<https://www.dji.com/osmo-mobile-7-series/downloads>

If you have any questions about this document, please contact DJI by sending a message to DocSupport@dji.com.

DJI and OSMO are trademarks of DJI.
Copyright © 2025 DJI All Rights Reserved.