

SAMSUNG

Product Guide

Bespoke 8700 Series Laundry

Available in Silver Steel and Brushed Black



Table of Contents

WF53BB8700 - Front Load Washer

Product Overview

Product Overview 4

Carousel Image Order 5

Product Messaging

Features and Benefits 8

Lifestyle Images 16

Product Specs

Related Products and Accessories 19

Spec Sheet 20

Energy Guide 21

User Manual and Warranty 22

Feature Icons 24

DVE53BB8700 - Electric Dryer

DVG53BB8700 - Gas Dryer

Product Overview

Product Overview 26

Carousel Image Order 27

Product Messaging

Features and Benefits 32

Product Specs

Related Products and Accessories 40

Spec Sheets 41

User Manual and Warranty 43

Feature Icons 45

Product Overview

WF53BB8700AT
WF53BB8700AV

**Bespoke 5.3 cu. ft. Ultra Capacity Front Load Washer
with Super Speed Wash and AI Smart Dial**

Product Overview

Product Title

Bespoke 5.3 cu. ft. Ultra Capacity Front Load Washer with Super Speed Wash and AI Smart Dial

Product Description (410 Characters)

Samsung's Bespoke 5.3 cu. ft. Ultra Capacity Front Load Washer has a sleek, flat-panel design, comes in new premium colors, and is equipped with smart features that simplify your laundry experience. It has our Super Speed Wash, which powerfully cleans a full load of laundry in just 28 minutes,* and our AI Smart Dial, which learns and recommends your favorite cycles** and makes controlling your washer a breeze.

*Based on using Super Speed cycle with an 8lb load.

** AI Smart Dial makes recommendations within 30 days of use based on cycle selections, time selected, and other factors.

Easy Ads Links

Silver Steel Washer: <https://dam.gettyimages.com/p/z0c3461/digital-appliances?o=AND&q=WF53BB8700AT>

Brushed Black Washer: <https://dam.gettyimages.com/p/z0c3461/digital-appliances?o=AND&q=WF53BB8700AV>

Available Colors



Silver Steel

Model Number: WF53BB8700AT

UPC: 887276652238



Brushed Black

Model Number: WF53BB8700AV

UPC: 887276652245



Carousel Image Order

WF53BB8700AT



Carousel Image Order

WF53BB8700AV





Product Messaging



WF53BB8700AT
WF53BB8700AV

**Bespoke 5.3 cu. ft. Ultra Capacity Front Load Washer
with Super Speed Wash and AI Smart Dial**



Features and Benefits: WF53BB8700*

Headline	Feature Name	Long Body Copy	Short Body Copy	Associated Image
<p>Bespoke design, intelligent wash</p>	<p>N/A</p>	<p>Laundry reimaged with a clean, flat-panel design and AI-powered features that simplify your cleaning routine. Choose from a variety of premium colors to create a laundry space that fits your style.</p>	<p>Flat-panel design, AI-powered features, and a variety of premium colors.</p>	
<p>Industry's largest capacity in its class*</p> <p><small>*As compared to 27" wide front load washers.</small></p>	<p>5.3 cu. ft. Ultra Capacity</p>	<p>Ultra Capacity lets you wash more items in a single load, meaning fewer loads, less time in the laundry room, and more time doing the things you love.</p>	<p>Fewer loads, less time in the laundry room.</p>	
<p>Wash a full load in just 28 minutes*</p> <p><small>*Based on using Super Speed cycle with an 8lb load.</small></p>	<p>Super Speed Wash</p>	<p>Wash a full load in just 28 minutes* without sacrificing cleaning performance, and achieve a complete wash and dry in under an hour when paired with a Super Speed Dryer.</p> <p><small>*Based on using Super Speed cycle with an 8lb load.</small></p>	<p>Powerful cleaning in just 28 minutes* and achieve a complete wash and dry in under an hour with an added Super Speed Dryer.</p> <p><small>*Based on using Super Speed cycle with an 8lb load.</small></p>	



Features and Benefits: WF53BB8700* (Continued)

Headline	Feature Name	Long Body Copy	Short Body Copy	Associated Image
<p>Make your laundry routine more simple</p>	<p>AI Smart Dial</p>	<p>Samsung's easy to use, AI Smart Dial simplifies your washer's control panel, learns and recommends your favorite cycles,* and allows you to customize your cycle list, making laundry day a breeze.</p> <p><small>*AI Smart Dial makes recommendations within 30 days of use based on cycle selections, time selected, and other factors.</small></p>	<p>Samsung's easy to use, AI Smart Dial simplifies your washer's control panel and makes laundry day a breeze.</p>	
<p>Controls within reach</p>	<p>MultiControl™</p>	<p>Eliminate the long reach and control your dryer right from your washer when the units are stacked.*</p> <p><small>*Use of this feature requires a stacked AI Smart Dial washer and dryer and Bespoke Stacking & MultiControl™ Combo Kit (SKK-9MC*), which is sold separately.</small></p>	<p>Control your dryer right from your washer when the units are stacked.*</p> <p><small>*Use of this feature requires a stacked AI Smart Dial washer and dryer and Bespoke Stacking & MultiControl™ Combo Kit (SKK-9MC*), which is sold separately.</small></p>	
<p>N/A</p>	<p>ENERGY STAR® Most Efficient</p>	<p>Our washers are recognized by the EPA in delivering cutting edge energy efficiency along with the latest in technological innovation.*</p> <p><small>*Visit www.energystar.gov for more information on ENERGY STAR® guidelines.</small></p>	<p>Recognized for delivering cutting edge energy efficiency and innovation.*</p> <p><small>*Visit www.energystar.gov for more information on ENERGY STAR® guidelines.</small></p>	

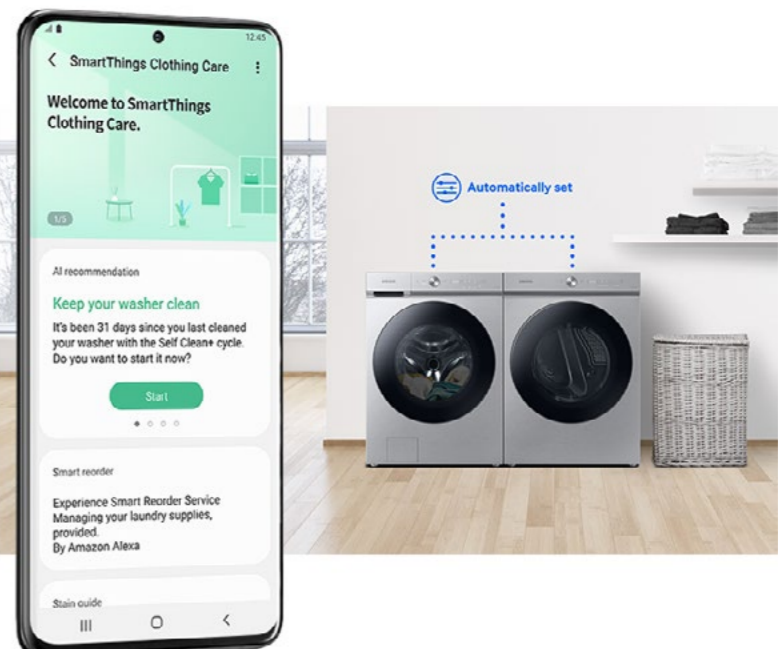

Features and Benefits: WF53BB8700* (Continued)

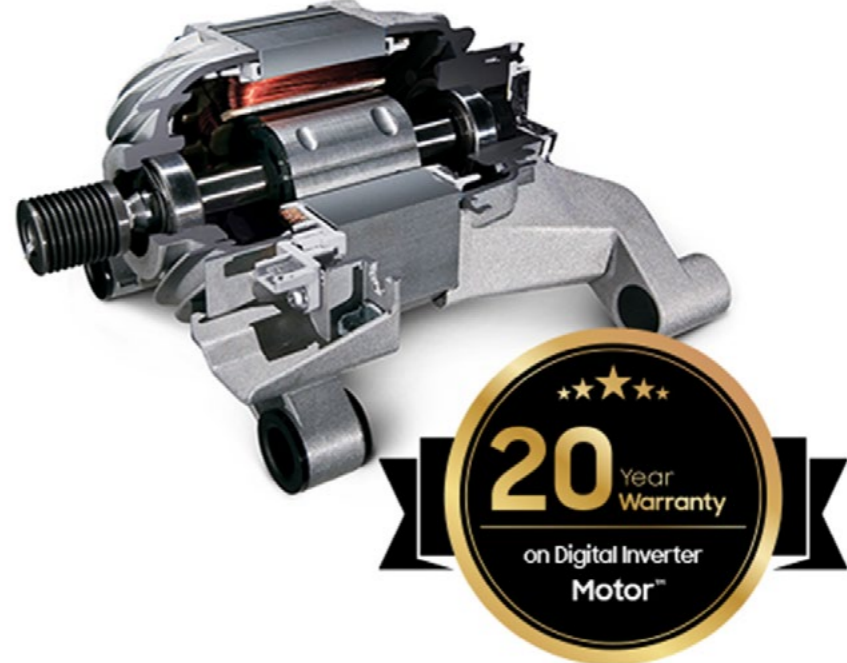
Headline	Feature Name	Long Body Copy	Short Body Copy	Associated Image
<p>Space-saving design</p>	<p>Shallow Closet-Depth Fit* *Designed to fit a 38" installation depth.</p>	<p>Perfect for any laundry space, this washer has a shallower depth for easy closet installation,* without sacrificing capacity. *Designed to fit a 38" installation depth.</p>	<p>A shallower depth allows for easy closet installation* without sacrificing capacity. *Designed to fit a 38" installation depth.</p>	
<p>Fits any space</p>	<p>Flexible Installation</p>	<p>Install your washer and dryer stacked or side by side to fit any space.</p>	<p>Your choice, stacked or side by side.</p>	
<p>Control in the palm of your hand</p>	<p>Wi-Fi Connectivity</p>	<p>Wi-Fi connected so you can get end-of-cycle alerts, remotely start and stop your wash, schedule cycles on your time and more, right from your smartphone with the SmartThings App.* *Requires wireless network, Samsung account and SmartThings App. Available on Android and iOS devices.</p>	<p>Get end of cycle alerts, remotely start, schedule, and more from your smartphone with the SmartThings App.* *Requires wireless network, Samsung account and SmartThings App. Available on Android and iOS devices.</p>	



Features and Benefits: WF53BB8700* (Continued)

Headline	Feature Name	Long Body Copy	Short Body Copy	Associated Image
<p>Purchase with confidence</p>	<p>20-Year Motor Warranty</p>	<p>Purchase with confidence any Samsung Washer model with a Digital Inverter Motor and receive a 20 year warranty on the motor.*</p> <p><small>*20-year warranty limited to the Digital Inverter Motor of washers purchased on 7/1/2022 or later. Purchase receipt indicating purchase date required for a claim. Additional restrictions and limitations apply, see warranty for details.</small></p>	<p>Purchase with confidence any Samsung Washer model with a Digital Inverter Motor and receive a 20 year warranty on the motor.*</p> <p><small>*20-year warranty limited to the Digital Inverter Motor of washers purchased on 7/1/2022 or later. Purchase receipt indicating purchase date required for a claim. Additional restrictions and limitations apply, see warranty for details.</small></p>	
<p>Gently remove stains</p>	<p>Steam</p>	<p>The power of steam lets you gently remove stains without any time-consuming pretreatments. Steam is released from the drum so every item in the load is thoroughly saturated, ensuring a deep clean.</p>	<p>The power of steam lets you gently remove stains without any time-consuming pretreatments.</p>	
<p>Open the door to a fresher washer</p>	<p>Antimicrobial Technology</p>	<p>The inside of the washer is treated with antimicrobial technology to help keep it smelling fresh.*</p> <p><small>*Antimicrobial treatment is applied to the gasket and does not protect users or other items against bacteria, viruses, germs, or other disease organisms.</small></p>	<p>Keep the inside of your washer smelling fresh with antimicrobial technology.*</p> <p><small>*Antimicrobial treatment is applied to the gasket and does not protect users or other items against bacteria, viruses, germs, or other disease organisms.</small></p>	

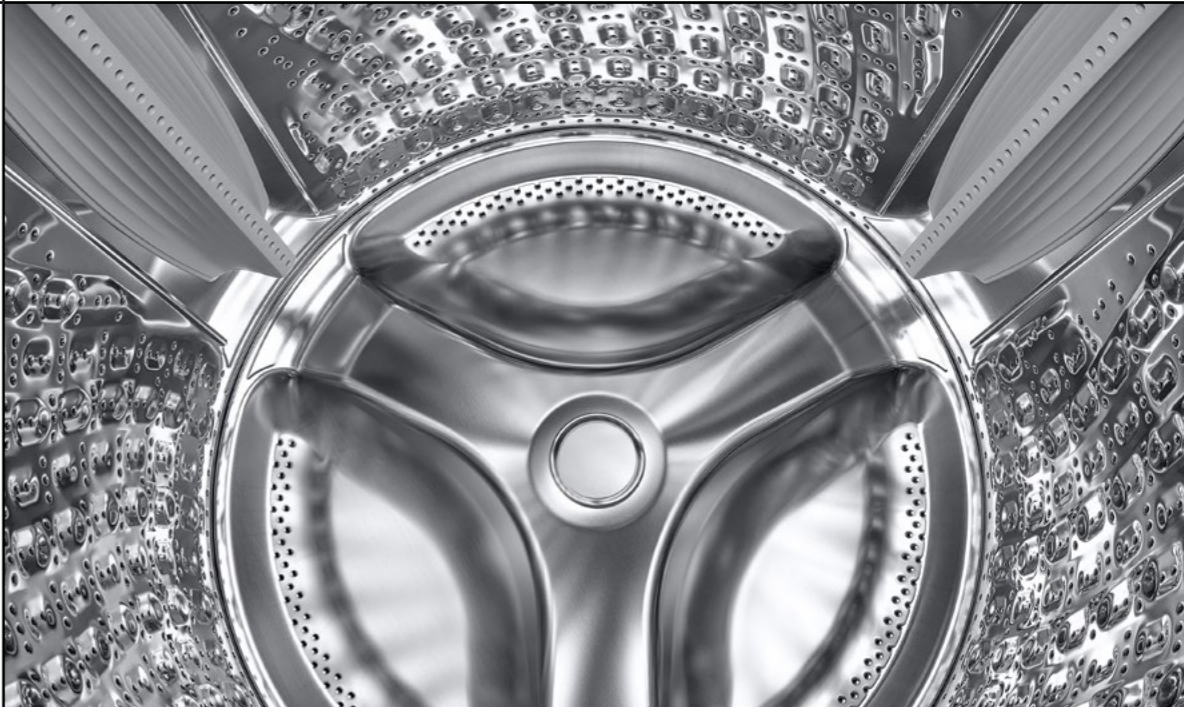

Features and Benefits: WF53BB8700* (Continued)

Headline	Feature Name	Long Body Copy	Short Body Copy	Associated Image
<p>Keep your washer fresh</p>	<p>Self Clean+</p>	<p>Self Clean+ cleans the inside of your washer to keep it smelling fresh and will also remind you every 40 wash cycles when it is time for a cleaning.</p>	<p>Self Clean+ cleans the inside of your washer and will remind you every 40 cycles when it is time for a cleaning.</p>	
<p>Beautiful design, built to last</p>	<p>Premium Tempered Glass Door</p>	<p>Made with a more scratch-resistant, flat tempered glass, our premium design door combines an upscale look with a durable finish.</p>	<p>A more scratch-resistant tempered glass door combines an upscale look with a durable finish.</p>	
<p>Quiet washing anytime, any place</p>	<p>Vibration Reduction Technology+</p>	<p>Do your laundry in peace. Our innovative Vibration Reduction Technology+ reduces noise and vibration and creates a quiet washing experience.</p>	<p>Reduces noise and vibration for quiet washing.</p>	

Features and Benefits: WF53BB8700* (Continued)

Headline	Feature Name	Long Body Copy	Short Body Copy	Associated Image
N/A	Swirl+ Drum Interior	The improved drum pattern draws out more water during the rinse cycle and helps prevent clothes from snagging during the wash.	Improved drum pattern draws out water more quickly and helps prevent snags.	
Put an end to stray socks	Internal Drum Light	An internal drum light lets you see the contents of your washer more clearly, meaning fewer missed socks or small items.	An internal drum light lets you see the contents of your washer more clearly.	
Easier use, for everyone	ADA Compliant	<p>With use of a Samsung Riser,* your washer or dryer is compliant with the Americans with Disabilities Act (ADA), making loading and unloading much easier.</p> <p><small>*ADA Compliant when using 27" wide riser. (Riser model codes: WE272NV, WE272NW, WE272NC)</small></p>	<p>Designed for easy use for everyone.*</p> <p><small>*ADA Compliant when using 27" wide riser. (Riser model codes: WE272NV, WE272NW, WE272NC)</small></p>	

Features and Benefits: WF53BB8700* (Continued)

Headline	Feature Name	Long Body Copy	Short Body Copy	Associated Image
<p>Perfect pair</p>	<p>Matching Dryer</p>	<p>Samsung washers and dryers team up to make light work of laundry day.</p>	<p>N/A</p>	
<p>N/A</p>	<p>Matching Accessories</p>	<p>Round out your laundry setup with a matching pedestal, riser, and more.</p>	<p>N/A</p>	

Lifestyle Images

WF53BB8700AT

WF53BB8700AV

**Bespoke 5.3 cu. ft. Ultra Capacity Front Load Washer
with Super Speed Wash and AI Smart Dial**

Lifestyle Images

Silver Steel Pair



Lifestyle Images

Brushed Black Pair



Product Specs

WF53BB8700AT

WF53BB8700AV

**Bespoke 5.3 cu. ft. Ultra Capacity Front Load Washer
with Super Speed Wash and AI Smart Dial**

Related Products and Accessories

Bespoke Dryer Series	Bespoke Pedestal	Riser	Bespoke Stacking & MultiControl™ Combo Kit
DVE53BB8700T DVG53BB8700T DVE53BB8700V DVG53BB8700V	WE502NT WE502NV	WE272NV	SKK-9MCT SKK-9MCTV

Spec Sheet

WF53BB8700
Bespoke 5.3 cu. ft. Ultra Capacity Front Load Washer with Super Speed Wash and AI Smart Dial



Available Colors

-  Silver Steel
WF53BB8700AT
-  Brushed Black
WF53BB8700AV

Features

- Bespoke Design
- 5.3 cu. ft. Ultra Capacity
- Super Speed Wash
- AI Smart Dial
- MultiControl™
- ENERGY STAR® Most Efficient
- Shallow Closet-Depth Fit¹
- Flexible Installation
- Wi-Fi Connectivity²
- Steam
- Antimicrobial Technology³
- Self Clean+
- Premium Tempered Glass Door
- Vibration Reduction Technology⁴
- Swift™ Drum Interior
- Internal Drum Light
- ADA Compliant⁵
- 1200 RPM Maximum Spin Speed
- Direct Drive Motor
- 24 Total Washing Cycles
- 14 Options

Specifications

24 Total Washing Cycles: Normal, Heavy Duty, Bedding, Permanent Press, Delicates, Activewear, Wool, Towels, Eco Cold, Rinse + Spin, Self Clean+, Small Load, Colors, Spin Only, Outdoor, Denim, Super Speed, Steam Sanitize, Steam Allergen, Steam Normal, Power Steam, Steam Whites, Steam Bulky, Power Rinse

14 Additional Washing Options: Presoak, Extra Rinse, My Cycles, Delay End, Smart Control, Super Speed, Drum Light, Child Lock, AI Pattern, Alarm, Calibration, Wi-Fi, Language, Factory Reset

5 Temperature Settings: Extra Hot, Hot, Warm, Cold, Tap Cold

7 Spin Settings: Extra High, High, Medium, Low, Extra Low, No Spin, No Drain

5 Soil Settings: Extra Heavy, Heavy, Normal, Light, Extra Light

Warranty
One (1) Year Parts and Labor
Three (3) Years Stainless Tub Part (Part Only)
Twenty (20) Years; Washing DIT (Digital Inverter Motor) Part (Part Only)

Product Dimensions & Weight (WxHxD)
Dimensions: 27" x 38 1/2" x 34 1/2"
Weight: 224.9 lbs

Shipping Dimensions & Weight (WxHxD)
Dimensions: 29 1/8" x 42 1/8" x 36 1/4"
Weight: 231.5 lbs

Convenience

- Child Lock
- Dispenser Trays: Main Wash, Softener, Bleach

Ratings

Most Efficient 2022

CEE Tier 3
IMEF = 3.1
IWF = 2.9
103 kWh/yr

Electrical Requirements
120 V / 60 Hz
15 Amps

SAMSUNG

¹ Designed to fit a 38" installation depth.
² Requires wireless network, Samsung account and Samsung SmartThings App. The Samsung SmartThings App supports Android OS 4.0 (ICS) or later which is optimized for Samsung smartphones (Galaxy S and Galaxy Note series). This app also supports iOS 7 or later for iPhone models. Samsung SmartThings App available in App Store and Play Store.
³ Antimicrobial treatment does not protect users or other items against bacteria, viruses, germs, or other disease organisms.
⁴ ADA Compliant when using 27" wide riser. (Riser model codes: WE272NV, WE272NW, WE272NC)

WF53BB8700
Bespoke 5.3 cu. ft. Ultra Capacity Front Load Washer with Super Speed Wash and AI Smart Dial

Dimensions
Required dimensions for installation with pedestal:

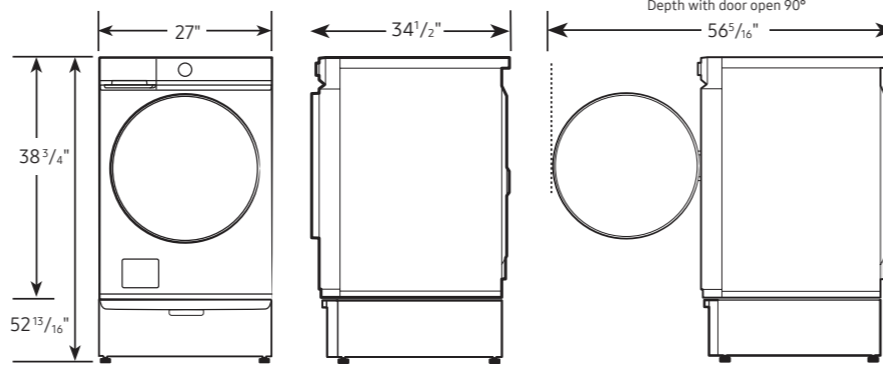

Installation Specifications – Side-by-Side
If the washer and dryer are installed together or the dryer alone, the closet front must have two unobstructed air openings for a combined minimum total area of 72-inch². Your washer alone does not require a specific air opening.

Connection Dimensions
Back view of washer

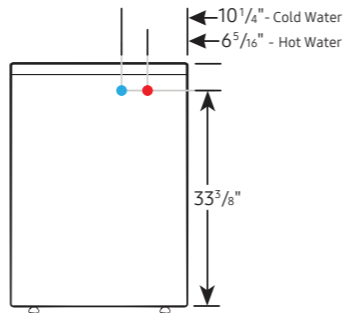

LEGEND:
● Cold Water Connection
● Hot Water Connection

Actual color may vary. Design, specifications, and color availability are subject to change without notice. Non-metric weights and measurements are approximate.
©2023 Samsung Electronics America, Inc. 85 Challenger Road, Ridgefield Park, NJ 07663. Tel: 800-840-2626, samsung.com, samsung.com registered trademark of Samsung Electronics Co., Ltd.

SAMSUNG

Washer Spec Sheet - page 2

WF53BB8700
Bespoke 5.3 cu. ft. Ultra Capacity Front Load Washer with Super Speed Wash and AI Smart Dial

Installation Specifications – Stacked Pair
Clearances indicated are for stacked pairs. The closet front must have two unobstructed air openings for a combined minimum total area of 72-inch².

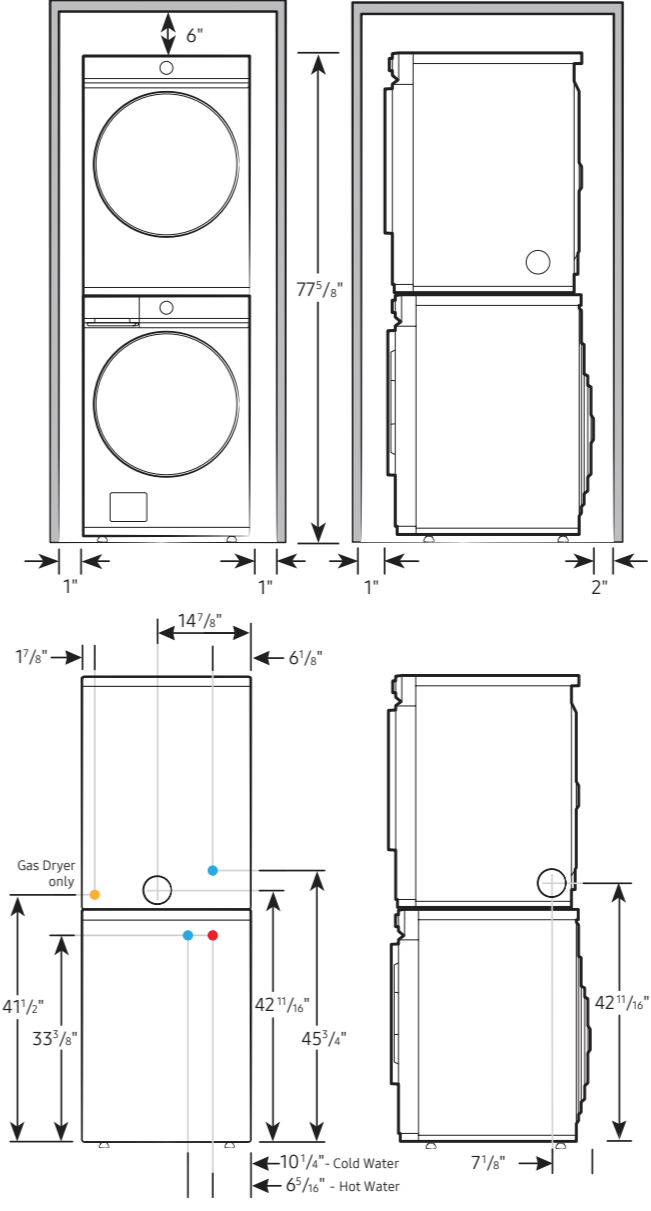

Connection Dimensions
Back and side views of stacked pair

LEGEND:
● Cold Water Connection
● Hot Water Connection
● Gas Connection

Actual color may vary. Design, specifications, and color availability are subject to change without notice. Non-metric weights and measurements are approximate.
©2023 Samsung Electronics America, Inc. 85 Challenger Road, Ridgefield Park, NJ 07663. Tel: 800-840-2626, samsung.com, samsung.com registered trademark of Samsung Electronics Co., Ltd.

SAMSUNG

Washer Spec Sheet - page 3

Energy Guide

U.S. Government Federal law prohibits removal of this label before consumer purchase.

ENERGYGUIDE

Clothes Washer
Capacity Class: Standard

Samsung
Models WF53BB89**A*
WF53BB87**A*

Capacity (tub volume): 5.3 cubic feet

Compare ONLY to other labels with yellow numbers.
Labels with yellow numbers are based on the same test procedures.

Estimated Yearly Energy Cost
(when used with an electric water heater)

\$12

\$8 Cost Range of Similar Models \$51

103 kWh
Estimated Yearly Electricity Use

\$10
Estimated Yearly Energy Cost
(when used with a natural gas water heater)

- Your cost will depend on your utility rates and use.
- Cost range based only on standard capacity models.
- Estimated energy cost based on six wash loads a week and a national average electricity cost of 12 cents per kWh and natural gas cost of \$1.09 per therm.

ftc.gov/energy



Energy Guide

User Manual and Warranty

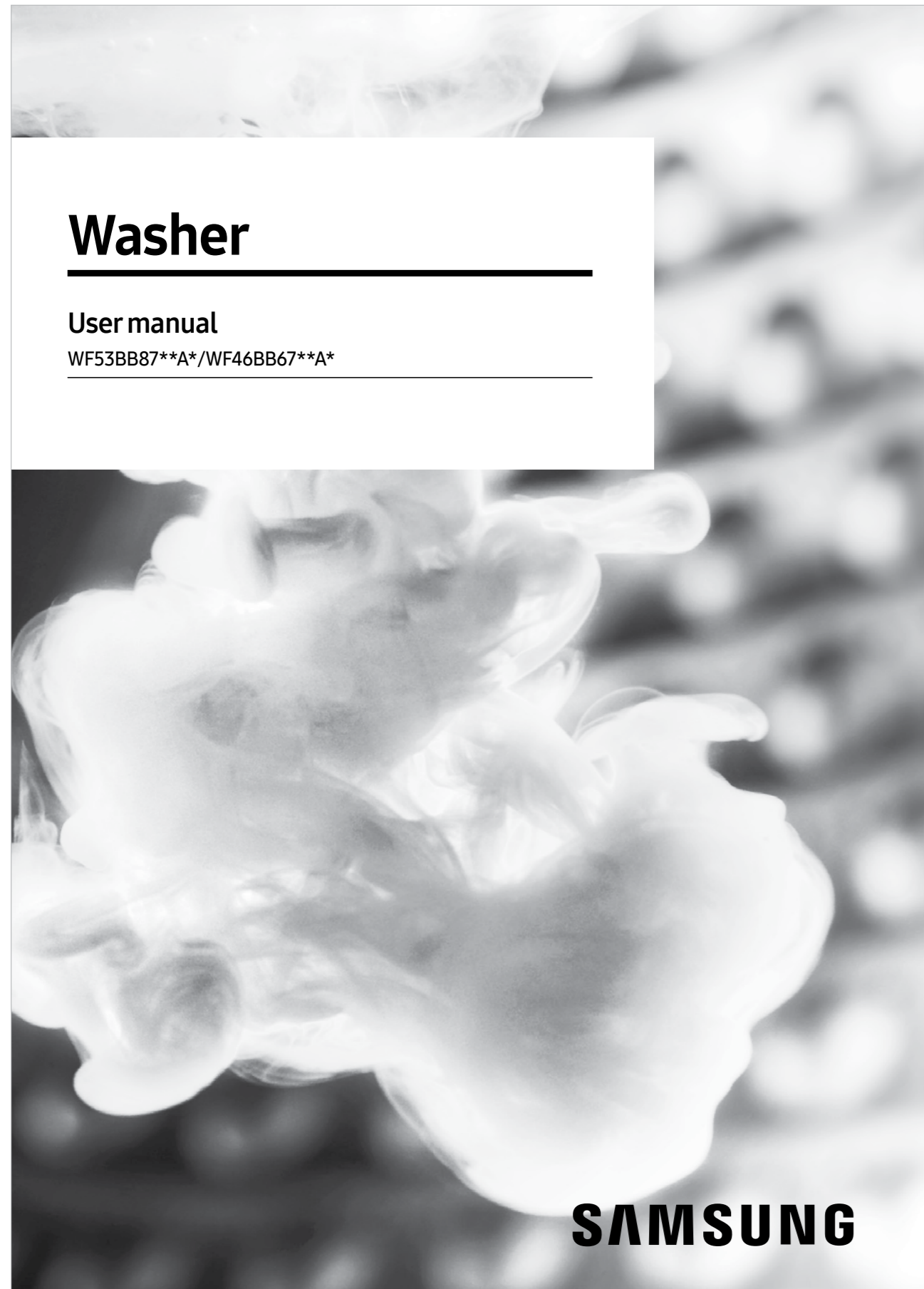

User Manual

LIMITED WARRANTY (U.S.A.) – SAMSUNG WASHER

Models:
WF53BB8700AT
WF53BB8700AV

LIMITED WARRANTY TO ORIGINAL PURCHASER WITH PROOF OF PURCHASE

This SAMSUNG brand product, as supplied and distributed by SAMSUNG ELECTRONICS AMERICA, INC. (SAMSUNG) and delivered new, in the original carton to the original consumer purchaser, is warranted by SAMSUNG against manufacturing defects in materials or workmanship for the limited warranty period, starting from the date of original purchase, of:

One (1) year Parts and labor
Three (3) years Stainless tub part (Part Only)
Twenty (20) years; Washing DIT (Digital Inverter Motor) motor part (Part Only)

This limited warranty is valid only on products purchased and used in the United States that have been installed, operated, and maintained according to the instructions attached to or furnished with the product. To receive warranty service, the purchaser must contact SAMSUNG at the address or phone number provided below for problem determination and service procedures. Warranty service can only be performed by a SAMSUNG authorized service center. The original dated bill of sale must be presented upon request as proof of purchase to SAMSUNG or SAMSUNG's authorized service center to receive warranty service.

SAMSUNG will provide in-home service within the contiguous United States during the warranty period at no charge, subject to availability of SAMSUNG authorized servicers within the customer's geographic area. If in-home service is not available, SAMSUNG may elect, at its option, to provide transportation of the product to and from an authorized service center. If the product is located in an area where service by a SAMSUNG authorized servicer is not available, you may be responsible for a trip charge or require to bring the product to a SAMSUNG authorized service center for service.

To receive in-home service, product must be unobstructed and accessible to the service agent.

During the applicable warranty period, a product will be repaired, replaced, or the purchase price refunded, at the sole option of SAMSUNG. SAMSUNG may use new or reconditioned parts in repairing a product, or replace the product with a new or reconditioned product. Replacement parts and products are warranted for the remaining portion of the original product's warranty or ninety (90) days, whichever is longer. All replaced parts and products are the property of SAMSUNG and you must return them to SAMSUNG.

This limited warranty covers manufacturing defects in materials or workmanship encountered in normal household, noncommercial use of this product and shall not cover the following: damage that occurs in shipment, delivery, installation, and uses for which this product was not intended; damage caused by unauthorized modification or alteration of the product; product where the original factory serial numbers have been removed, defaced, changed in any way, or cannot be readily determined; cosmetic damage including scratches, dents, chips, and other damage to the product's finishes;

Warranty

Feature Icons

WF53BB8700AT
WF53BB8700AV

**Bespoke 5.3 cu. ft. Ultra Capacity Front Load Washer
with Super Speed Wash and AI Smart Dial**

Feature Icons

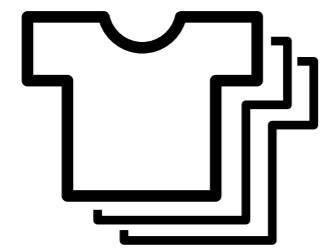

5.3 cu. ft. Ultra Capacity



Super Speed Wash

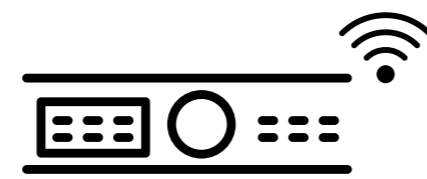

AI Smart Dial



MultiControl™



ENERGY STAR®
Most Efficient

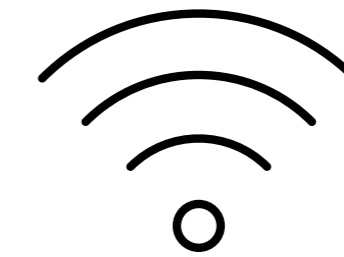

Wi-Fi Connectivity



20-Year Motor Warranty*

*20-year warranty limited to the Digital Inverter Motor of washers purchased on 7/1/2022 or later. Purchase receipt indicating purchase date required for a claim. Additional restrictions and limitations apply, see warranty for details.

Product Overview

DVE53BB8700T / DVG53BB8700T
DVE53BB8700V / DVG53BB8700V

**Bespoke 7.6 cu. ft. Ultra Capacity Electric Dryer
with Super Speed Dry and AI Smart Dial**
**Bespoke 7.6 cu. ft. Ultra Capacity Gas Dryer
with Super Speed Dry and AI Smart Dial**

Product Overview

Product Titles

DVE53BB8700 - Bespoke 7.6 cu. ft. Ultra Capacity Electric Dryer with Super Speed Dry and AI Smart Dial

DVG53BB8700 - Bespoke 7.6 cu. ft. Ultra Capacity Gas Dryer with Super Speed Dry and AI Smart Dial

Electric Dryer Description (380 Characters)

Samsung's Bespoke Ultra Capacity Electric Dryer has a sleek, flat-panel design, comes in new premium colors, and is equipped with smart features that simplify your laundry experience. It has our Super Speed Dry, which optimally dries a full load in just 30 minutes,* and our AI Smart Dial, which learns and recommends your favorite cycles** and makes controlling your dryer a breeze.

Gas Dryer Description (375 Characters)

Samsung's Bespoke Ultra Capacity Gas Dryer has a sleek, flat-panel design, comes in new premium colors, and is equipped with smart features that simplify your laundry experience. It has our Super Speed Dry, which optimally dries a full load in just 30 minutes,* and our AI Smart Dial, which learns and recommends your favorite cycles** and makes controlling your dryer a breeze.

*Based on 8lb D.O.E. standard load (50% cotton, 50% poly).

**AI Smart Dial makes recommendations within 30 days of use based on cycle selections, time selected, and other factors.

Easy Ads Links

Silver Steel Electric and Gas Dryer: https://dam.gettyimages.com/p/z0c3461/digital-appliances?o=AND&q=DV*53BB8700T

Brushed Black Electric and Gas Dryer: https://dam.gettyimages.com/p/z0c3461/digital-appliances?o=AND&q=DV*53BB8700V

Available Colors



Silver Steel

Electric Dryer Model Number: DVE53BB8700T

Electric Dryer UPC: 887276657233

Gas Dryer Model Number: DVG53BB8700T

Gas Dryer UPC: 887276657295



Brushed Black

Electric Dryer Model Number: DVE53BB8700V

Electric Dryer UPC: 887276657240

Gas Dryer Model Number: DVG53BB8700V

Gas Dryer UPC: 887276657301



Carousel Image Order

Electric Dryer - DVE53BB8700T



Carousel Image Order

Gas Dryer - DVG53BB8700T



Carousel Image Order

Electric Dryer - DVE53BB8700V



Carousel Image Order

Gas Dryer - DVG53BB8700V





Product Messaging



DVE53BB8700T / DVG53BB8700T
DVE53BB8700V / DVG53BB8700V

**Bespoke 7.6 cu. ft. Ultra Capacity Electric Dryer
with Super Speed Dry and AI Smart Dial**
**Bespoke 7.6 cu. ft. Ultra Capacity Gas Dryer
with Super Speed Dry and AI Smart Dial**



Features and Benefits: DVE(G)53BB8700*

Headline	Feature Name	Long Body Copy	Short Body Copy	Associated Image
<p>Bespoke design, intelligent dry</p>	<p>N/A</p>	<p>Laundry reimagined with a clean, flat-panel design and AI-powered features that simplify your cleaning routine. Choose from a variety of premium colors to create a laundry space that fits your style.</p>	<p>Flat-panel design, AI-powered features, and a variety of premium colors.</p>	
<p>Dry a full load in 30 minutes* <small>*Based on 8lb D.O.E. standard load (50% cotton, 50% poly).</small></p>	<p>Super Speed Dry</p>	<p>Dry a full load in just 30 minutes* and achieve a complete wash and dry in under an hour with an added Super Speed Washer. <small>*Based on 8lb D.O.E. standard load (50% cotton, 50% poly).</small></p>	<p>Dry in just 30 minutes* and achieve a complete wash and dry in under an hour with an added Super Speed Washer. <small>*Based on 8lb D.O.E. standard load (50% cotton, 50% poly).</small></p>	
<p>Make your laundry routine more simple</p>	<p>AI Smart Dial</p>	<p>Samsung's easy to use, AI Smart Dial simplifies your dryer's control panel, learns and recommends your favorite cycles,* and allows you to customize your cycle list, making laundry day a breeze. <small>*AI Smart Dial makes recommendations within 30 days of use based on cycle selections, time selected, and other factors.</small></p>	<p>Samsung's easy to use, AI Smart Dial simplifies your dryer's control panel and makes laundry day a breeze.</p>	



Features and Benefits: DVE(G)53BB8700* (Continued)

Headline	Feature Name	Long Body Copy	Short Body Copy	Associated Image
<p>Controls within reach</p>	<p>MultiControl™</p>	<p>Eliminate the long reach and control your dryer right from your washer when the units are stacked.*</p> <p><small>*Use of this feature requires a stacked AI Smart Dial washer and dryer and Bespoke Stacking & MultiControl™ Combo Kit (SKK-9MC*), which is sold separately.</small></p>	<p>Control your dryer right from your washer when the units are stacked.*</p> <p><small>*Use of this feature requires a stacked AI Smart Dial washer and dryer and Bespoke Stacking & MultiControl™ Combo Kit (SKK-9MC*), which is sold separately.</small></p>	
<p>Freshen up clothes</p>	<p>Steam Sanitize+</p>	<p>Our Steam Sanitize+ cycle removes 95% of pollen* from fabric, while Multi-Steam refreshes clothing and relaxes light wrinkles.</p> <p><small>*Testing based on Samsung internal protocols. Results provided to and interpreted by Intertek. Individual results may vary.</small></p>	<p>Removes 95% of pollen from fabric,* relaxes light wrinkles, and refreshes clothing.</p> <p><small>*Testing based on Samsung internal protocols. Results provided to and interpreted by Intertek. Individual results may vary.</small></p>	 <p>ODOR Refresh Cycle WRINKLES Wrinkles Away Cycle ANTISTATIC Anti Static Function(*Option)</p>
<p>N/A</p>	<p>ENERGY STAR® Certified</p>	<p>ENERGY STAR® Certified,* so you use less energy without sacrificing performance or functionality.</p> <p><small>*Visit www.energystar.gov for more information on ENERGY STAR® guidelines.</small></p>	<p>Eco-friendly and energy-efficient.</p>	

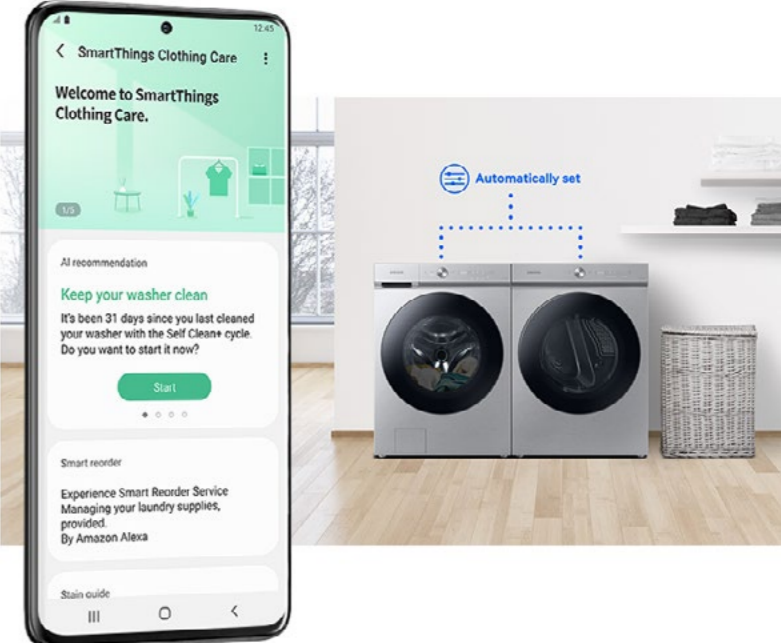

Features and Benefits: DVE(G)53BB8700* (Continued)

Headline	Feature Name	Long Body Copy	Short Body Copy	Associated Image
<p>Space-saving design</p>	<p>Shallow Closet-Depth Fit* *Designed to fit a 38" installation depth.</p>	<p>Perfect for any laundry space, this dryer has a shallower depth for easy closet installation,* without sacrificing capacity. *Designed to fit a 38" installation depth.</p>	<p>A shallower depth allows for easy closet installation* without sacrificing capacity. *Designed to fit a 38" installation depth.</p>	
<p>Fits any space</p>	<p>Flexible Installation</p>	<p>Install your washer and dryer stacked or side by side to fit any space.</p>	<p>Your choice, stacked or side by side.</p>	
<p>Control in the palm of your hand</p>	<p>Wi-Fi Connectivity</p>	<p>Wi-Fi connected so you can get end-of-cycle alerts, remotely start and stop your dryer, schedule cycles on your time, and more right from your smartphone with the SmartThings App.* *Requires wireless network, Samsung account and SmartThings App. The Samsung SmartThings App supports Android OS 4.0 (ICS) or later which is optimized for Samsung smartphones (Galaxy S and Galaxy Note series). This app also supports iOS 7 or later for iPhone models. SmartThings App available in App Store and Play Store. Only monitoring enabled on Gas Dryers for safety reasons.</p>	<p>Get end of cycle alerts, remotely start, schedule and more from your smartphone with the SmartThings App.* *Requires wireless network, Samsung account and SmartThings App. The Samsung SmartThings App supports Android OS 4.0 (ICS) or later which is optimized for Samsung smartphones (Galaxy S and Galaxy Note series). This app also supports iOS 7 or later for iPhone models. SmartThings App available in App Store and Play Store. Only monitoring enabled on Gas Dryers for safety reasons.</p>	



Features and Benefits: DVE(G)53BB8700* (Continued)

Headline	Feature Name	Long Body Copy	Short Body Copy	Associated Image
<p>Worry-free drying</p>	<p>Sensor Dry</p>	<p>Automatically optimizes the time and temperature of your drying cycle to protect your clothes from heat damage, while avoiding excess energy use.</p>	<p>Helps prevent overdrying for optimal fabric care.</p>	
<p>Dry more items in a single load</p>	<p>7.6 cu. ft. Ultra Capacity</p>	<p>Fewer loads, less time in the laundry room, and more time doing the things you love.</p>	<p>Fewer loads, less time in the laundry room.</p>	
<p>Cleaner, safer vents</p>	<p>Vent Sensor</p>	<p>A sensor continuously monitors the condition of your dryer's air duct to make sure it's running safely and efficiently. Plus, automatic alerts let you know when it's time to clean your air duct or check for obstructions so performance stays at its peak.</p>	<p>Continuously monitors the condition of your dryer's air duct to make sure it's running safely and efficiently.</p>	



Features and Benefits: DVE(G)53BB8700* (Continued)

Headline	Feature Name	Long Body Copy	Short Body Copy	Associated Image
<p>Stop the fluff</p>	<p>Lint Filter Indicator</p>	<p>Worry less about lint or fluff blocking the dryer's air intake. The control panel provides a helpful reminder to clean the filter to keep your dryer running smoothly.</p>	<p>The control panel lets you know when it's time to clean the filter.</p>	
<p>Materials that last</p>	<p>Stainless Steel Drum</p>	<p>Keep your dryer looking like new with a durable stainless steel drum that helps prevent nicks and scratches.</p>	<p>A durable stainless steel drum helps prevent nicks and scratches.</p>	
<p>Beautiful design, built to last</p>	<p>Premium Tempered Glass Door</p>	<p>Made with a more scratch-resistant, flat tempered glass, our premium design door combines an upscale look with a durable finish.</p>	<p>A more scratch-resistant tempered glass door combines an upscale look with a durable finish.</p>	

Features and Benefits: DVE(G)53BB8700* (Continued)

Headline	Feature Name	Long Body Copy	Short Body Copy	Associated Image
<p>Put an end to stray socks</p>	<p>Internal Drum Light</p>	<p>An internal drum light lets you see the contents of your dryer more clearly, meaning fewer missed socks or small items.</p>	<p>An internal drum light lets you see the contents of your dryer more clearly.</p>	
<p>N/A</p>	<p>Drying Rack</p>	<p>The included drying rack provides a perfect place to gently dry delicate items, sweaters and footwear.</p>	<p>The included drying rack provides a perfect place to gently dry delicate items.</p>	
<p>Flexible opening</p>	<p>Reversible Dryer Door</p>	<p>Choose which way your dryer door opens to better suit your laundry room layout.</p>	<p>Choose which way your dryer door opens.</p>	

Features and Benefits: DVE(G)53BB8700* (Continued)

Headline	Feature Name	Long Body Copy	Short Body Copy	Associated Image
<p>Easier use, for everyone</p>	<p>ADA Compliant</p>	<p>With use of a Samsung Riser,* your washer or dryer is compliant with the Americans with Disabilities Act (ADA), making loading and unloading much easier.</p> <p><small>*ADA Compliant when using 27" wide riser.(Riser model codes: WE272NV, WE272NW, WE272NC)</small></p>	<p>Designed for easy use for everyone.*</p> <p><small>*ADA Compliant when using 27" wide riser.(Riser model codes: WE272NV, WE272NW, WE272NC)</small></p>	
<p>Perfect pair</p>	<p>Matching Washer</p>	<p>Samsung washers and dryers team up to make light work of laundry day.</p>	<p>N/A</p>	
<p>N/A</p>	<p>Matching Accessories</p>	<p>Round out your laundry setup with a matching pedestal, riser, and more.</p>	<p>N/A</p>	

Product Specs

DVE53BB8700T / DVG53BB8700T
DVE53BB8700V / DVG53BB8700V

**Bespoke 7.6 cu. ft. Ultra Capacity Electric Dryer
with Super Speed Dry and AI Smart Dial**
**Bespoke 7.6 cu. ft. Ultra Capacity Gas Dryer
with Super Speed Dry and AI Smart Dial**

Related Products and Accessories

Bespoke Washer Series	Bespoke Pedestal	Riser	Bespoke Stacking & MultiControl™ Combo Kit	Gas to Propane Converter Kit	Side Vent Kit
WF53BB8700AT WF53BB8700AV	WE502NT WE502NV	WE272NV	SKK-9MCT SKK-9MCV	LPKIT-4	DV-2A

Spec Sheet

DVE53BB8700
Bespoke 7.6 cu. ft. Ultra Capacity Electric Dryer with Super Speed Dry and AI Smart Dial



Available Colors

- Silver Steel
DVE53BB8700T
- Brushed Black
DVE53BB8700V

Features

- Bespoke Design
- Super Speed Dry
- AI Smart Dial
- MultiControl™
- Steam Sanitize+
- ENERGY STAR® Certified
- Shallow Closet-Depth Fit¹
- Flexible Installation
- Wi-Fi Connectivity²
- Sensor Dry
- 7.6 cu. ft. Ultra Capacity
- Vent Sensor
- Lint Filter Indicator
- Stainless Steel Drum
- Premium Tempered Glass Door
- Internal Drum Light
- Drying Rack
- Reversible Dryer Door
- ADA Compliant³
- 19 Total Drying Cycles
- 14 Options
- 5 Temperature Settings
- 4-Way Venting

Specifications

19 Preset Drying Cycles: Steam Refresh, Wrinkle Away, Steam Sanitize+, Super Speed, Eco Normal, Normal, Heavy Duty, Towels, Permanent Press, Activewear, Bedding, Delicates, Wool, Shirts, Denim, Time Dry, Air Fluff, Small Load, Rack Dry

14 Options: Damp Alert, Wrinkle Prevent, AntiStatic, My Cycles, Smart Control, Eco Dry, Drum Light, Child Lock, Alarm, AI Pattern, Wi-Fi, Language, Vent Blockage Test, Factory Reset

5 Temperature Settings: High, Medium, Medium Low, Low, Extra Low

5 Dry Levels: Very Dry, More Dry, Normal Dry, Less Dry, Damp Dry

Warranty
Two (2) Years Parts and Labor*
*Effective for purchases made between 10/1/22 - 9/30/23; proof of purchase required.

Product Dimensions & Weight (WxHxD)
Dimensions: 27" x 38 3/4" x 31 1/8"
Weight: 121.3 lbs

Shipping Dimensions & Weight (WxHxD)
Dimensions: 29 1/4" x 42 11/16" x 34 11/16"
Weight: 130.1 lbs

Electric Dryer	Model #	UPC Code	Optional Accessories	Model #	UPC Code
Silver Steel	DVE53BB8700T	887276657233	Silver Steel Pedestal	WE502NT	887276665283
Brushed Black	DVE53BB8700V	887276657240	Brushed Black Pedestal	WE502NV	887276665290
Gas Dryer			Brushed Black Riser	WE272NV	887276197630
Silver Steel	DVG53BB8700T	887276657295	Silver Steel Bespoke Stacking and MultiControl™ Combo Kit	SKK-9MCT	887276667379
Brushed Black	DVG53BB8700V	887276657301	Brushed Black Bespoke Stacking and MultiControl™ Combo Kit	SKK-9MCV	887276667386
Matching Washer			Vent Kit	DV-2A	887276146416
Silver Steel	WF53BB8700AT	887276652238			
Brushed Black	WF53BB8700AV	887276652245			

Convenience

- Child Lock
- Filter Check Indicator

Ratings

ENERGY STAR® Rated:
608 kWh/yr

Electrical Requirements
240 V / 60 Hz
30 Amps

¹Designed to fit a 38" installation depth.
²Requires wireless network, Samsung account and SmartThings App. The Samsung SmartThings App supports Android OS 4.0 (ICS) or later which is optimized for Samsung smartphones (Galaxy S and Galaxy Note series). This app also supports iOS 7 or later for iPhone models. SmartThings App available in App Store and Play Store. Only monitoring enabled on Gas Dryers for safety reasons.
³ADA Compliant when using 27" wide riser. (Riser model codes: WE272NV, WE272NW, WE272NC)

SAMSUNG

Electric Dryer Spec Sheet - page 1

DVE53BB8700
Bespoke 7.6 cu. ft. Ultra Capacity Electric Dryer with Super Speed Dry and AI Smart Dial

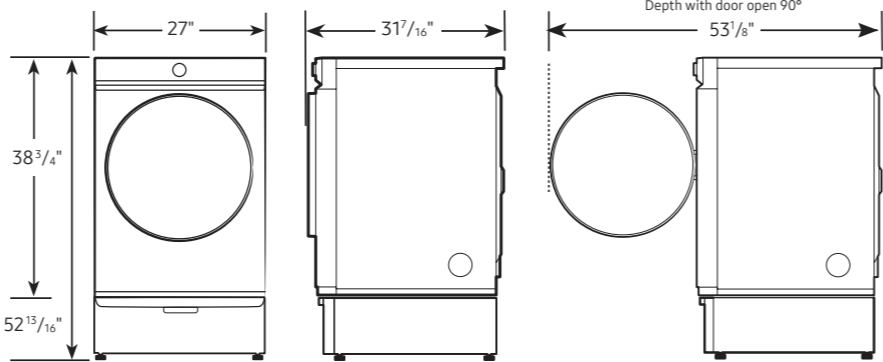

Dimensions
Required dimensions for installation with pedestal:

Installation Specifications – Side-by-Side
If the washer and dryer are installed together or the dryer alone, the closet front must have two unobstructed air openings for a combined minimum total area of 72-inch². Your washer alone does not require a specific air opening.

Alcove or closet installation
Minimum clearance for closet and alcove installations:

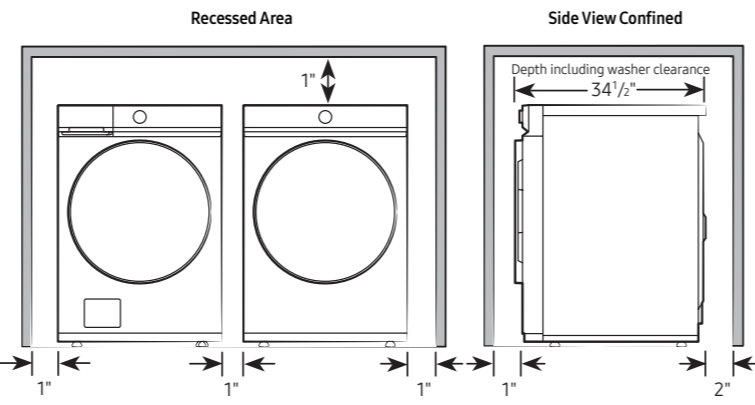

Connection Dimensions
Back and side view of dryer

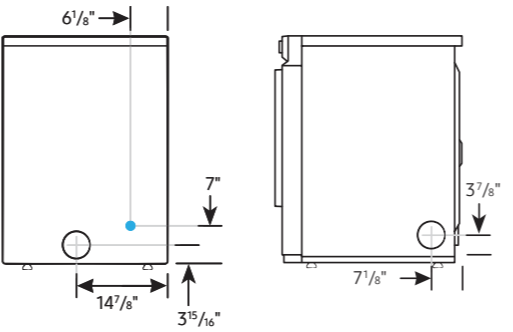

LEGEND:
● Cold Water Connection
● Hot Water Connection

Actual color may vary. Design, specifications, and color availability are subject to change without notice. Non-metric weights and measurements are approximate.
©2022 Samsung Electronics America, Inc.
85 Challenger Road, Ridgefield Park, NJ 07660.
Tel: 800-SAMSUNG, samsung.com. Samsung is a registered trademark of Samsung Electronics Co., Ltd.

SAMSUNG

Electric Dryer Spec Sheet - page 2

DVE53BB8700
Bespoke 7.6 cu. ft. Ultra Capacity Electric Dryer with Super Speed Dry and AI Smart Dial

Installation Specifications – Stacked Pair
Clearances indicated are for stacked pairs. The closet front must have two unobstructed air openings for a combined minimum total area of 72-inch².

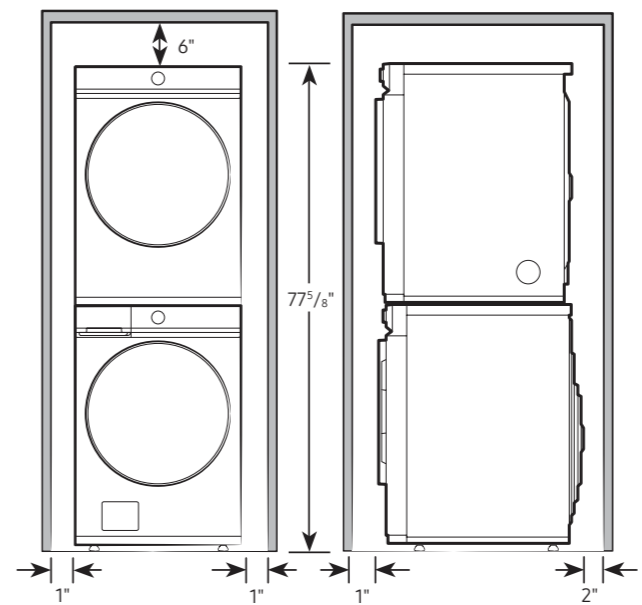

Connection Dimensions
Back and side views of stacked pair

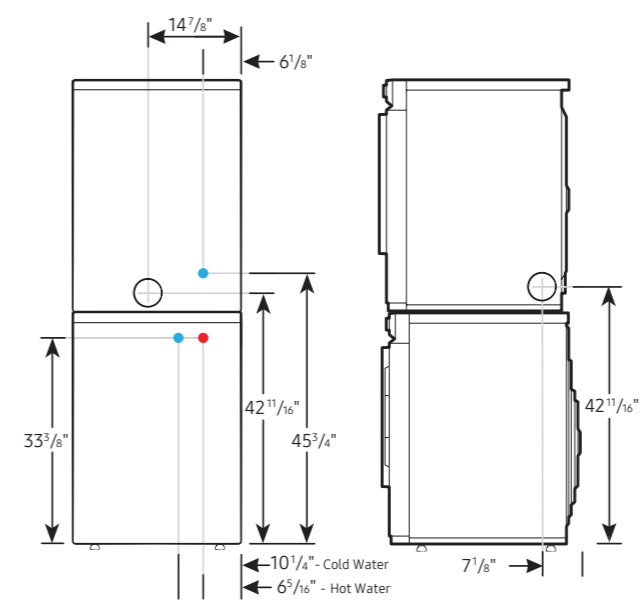

LEGEND:
● Cold Water Connection
● Hot Water Connection

Actual color may vary. Design, specifications, and color availability are subject to change without notice. Non-metric weights and measurements are approximate.
©2022 Samsung Electronics America, Inc.
85 Challenger Road, Ridgefield Park, NJ 07660.
Tel: 800-SAMSUNG, samsung.com. Samsung is a registered trademark of Samsung Electronics Co., Ltd.

SAMSUNG

Electric Dryer Spec Sheet - page 3

Spec Sheet

DVG53BB8700
Bespoke 7.6 cu. ft. Ultra Capacity Gas Dryer with Super Speed Dry and AI Smart Dial



Available Colors

- Silver Steel
DVG53BB8700T
- Brushed Black
DVG53BB8700V

Features

- Bespoke Design
- Super Speed Dry
- AI Smart Dial
- MultiControl™
- Steam Sanitize+
- ENERGY STAR® Certified
- Shallow Closet-Depth Fit¹
- Flexible Installation
- Wi-Fi Connectivity²
- Sensor Dry
- Vent Sensor
- 7.6 cu. ft. Ultra Capacity
- Lint Filter Indicator
- Stainless Steel Drum
- Premium Tempered Glass Door
- Internal Drum Light
- Drying Rack
- Reversible Dryer Door
- ADA Compliant³
- 19 Total Drying Cycles
- 14 Options
- 5 Temperature Settings
- 3-Way Venting

Specifications

19 Preset Drying Cycles: Steam Refresh, Wrinkle Away, Steam Sanitize+, Super Speed, Eco Normal, Normal, Heavy Duty, Towels, Permanent Press, Activewear, Bedding, Delicates, Wool, Shirts, Denim, Time Dry, Air Fluff, Small Load, Rack Dry

14 Options: Damp Alert, Wrinkle Prevent, AntiStatic, My Cycles, Smart Control, Eco Dry, Drum Light, Child Lock, Alarm, AI Pattern, Wi-Fi, Language, Vent Blockage Test, Factory Reset

5 Temperature Settings: High, Medium, Medium Low, Low, Extra Low

5 Dry Levels: Very Dry, More Dry, Normal Dry, Less Dry, Damp Dry

Warranty
Two (2) Years Parts and Labor*
*Effective for purchases made between 10/1/22 - 9/30/23; proof of purchase required.

Product Dimensions & Weight (WxHxD)
Dimensions: 27" x 38 1/4" x 31 1/16"
Weight: 121.5 lbs

Shipping Dimensions & Weight (WxHxD)
Dimensions: 29 1/4" x 42 1/16" x 34 11/16"
Weight: 130.1 lbs

Gas Dryer	Model #	UPC Code	Optional Accessories	Model #	UPC Code
Silver Steel	DVG53BB8700T	887276657295	Silver Steel Pedestal	WE502NT	887276665283
Brushed Black	DVG53BB8700V	887276657301	Brushed Black Pedestal	WE502NV	887276665290
			Brushed Black Riser	WE272NV	887276197630
			Silver Steel Bespoke Stacking and MultiControl™ Combo Kit	SKK-9MCT	887276667379
			Brushed Black Bespoke Stacking and MultiControl™ Combo Kit	SKK-9MCV	887276667386
			Vent Kit	DV-2A	887276146416
			Gas to Propane Converter Kit	LPKIT-4	887276352787

Matching Washer

Silver Steel	WF53BB8700AT	887276652238
Brushed Black	WF53BB8700AV	887276652245

Electrical Requirements
120 V / 60 Hz
15 Amps

Convenience

- Child Lock
- Filter Check Indicator

Connection Dimensions

Back and side view of dryer

LEGEND:

- Cold Water Connection
- Hot Water Connection
- Gas Connection

Actual color may vary. Design, specifications, and color availability are subject to change without notice. Non-metric weights and measurements are approximate.

©2022 Samsung Electronics America, Inc. 85 Challenger Road, Ridgefield Park, NJ 07660. Tel: 800-SAMSUNG. samsung.com. Samsung is a registered trademark of Samsung Electronics Co., Ltd.

SAMSUNG

Gas Dryer Spec Sheet - page 1

DVG53BB8700
Bespoke 7.6 cu. ft. Ultra Capacity Gas Dryer with Super Speed Dry and AI Smart Dial

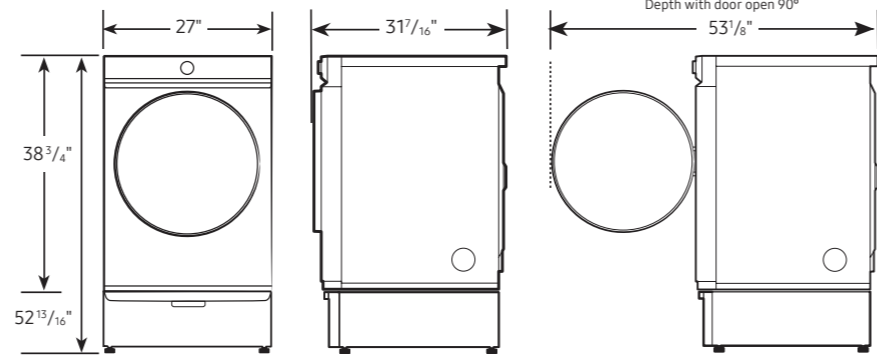

Dimensions
Required dimensions for installation with pedestal:

Installation Specifications – Side-by-Side
If the washer and dryer are installed together or the dryer alone, the closet front must have two unobstructed air openings for a combined minimum total area of 72-inch². Your washer alone does not require a specific air opening.

Alcove or closet installation
Minimum clearance for alcove and alcove installations:

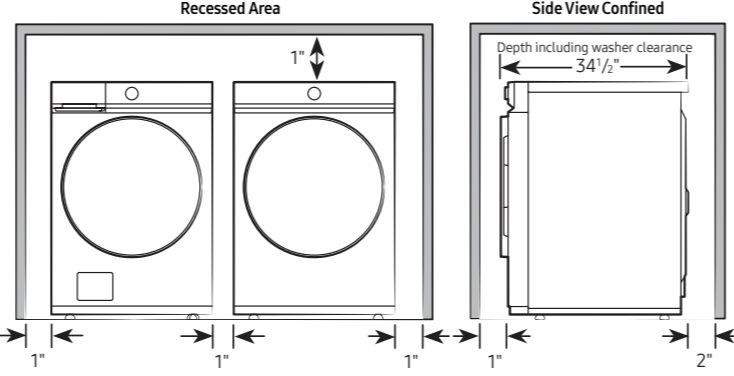

Connection Dimensions
Back and side view of dryer

LEGEND:

- Cold Water Connection
- Hot Water Connection
- Gas Connection

Actual color may vary. Design, specifications, and color availability are subject to change without notice. Non-metric weights and measurements are approximate.

©2022 Samsung Electronics America, Inc. 85 Challenger Road, Ridgefield Park, NJ 07660. Tel: 800-SAMSUNG. samsung.com. Samsung is a registered trademark of Samsung Electronics Co., Ltd.

SAMSUNG

Gas Dryer Spec Sheet - page 2

DVG53BB8700
Bespoke 7.6 cu. ft. Ultra Capacity Gas Dryer with Super Speed Dry and AI Smart Dial

Installation Specifications – Stacked Pair
Clearances indicated are for stacked pairs. The closet front must have two unobstructed air openings for a combined minimum total area of 72-inch².

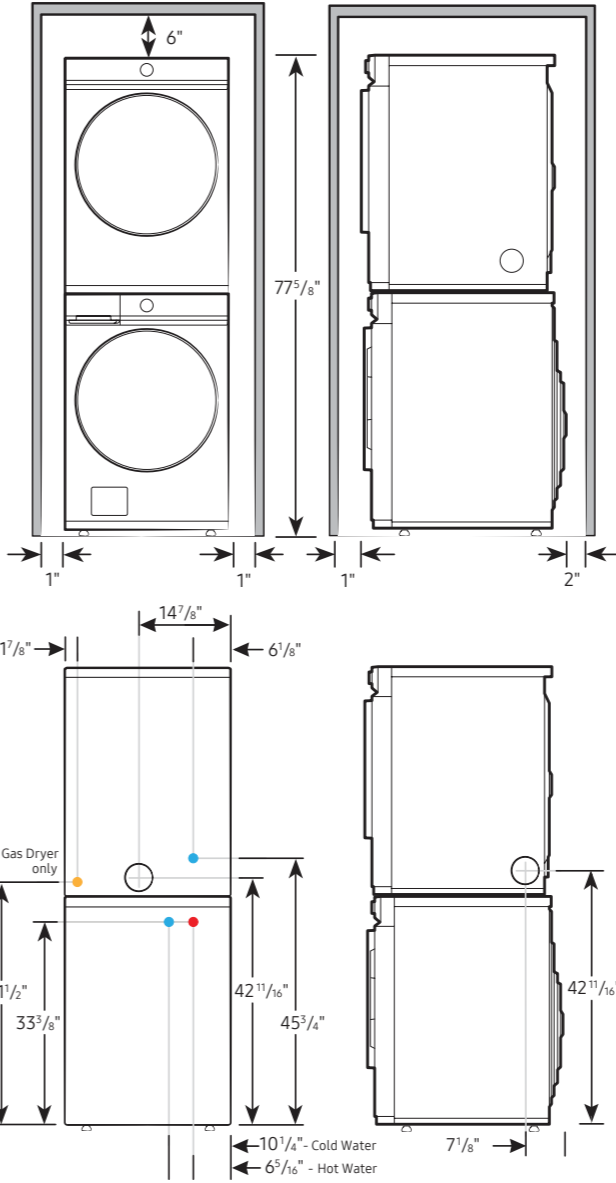

Connection Dimensions
Back and side views of stacked pair

LEGEND:

- Cold Water Connection
- Hot Water Connection
- Gas Connection

Actual color may vary. Design, specifications, and color availability are subject to change without notice. Non-metric weights and measurements are approximate.

©2022 Samsung Electronics America, Inc. 85 Challenger Road, Ridgefield Park, NJ 07660. Tel: 800-SAMSUNG. samsung.com. Samsung is a registered trademark of Samsung Electronics Co., Ltd.

SAMSUNG

Gas Dryer Spec Sheet - page 3

User Manual and Warranty

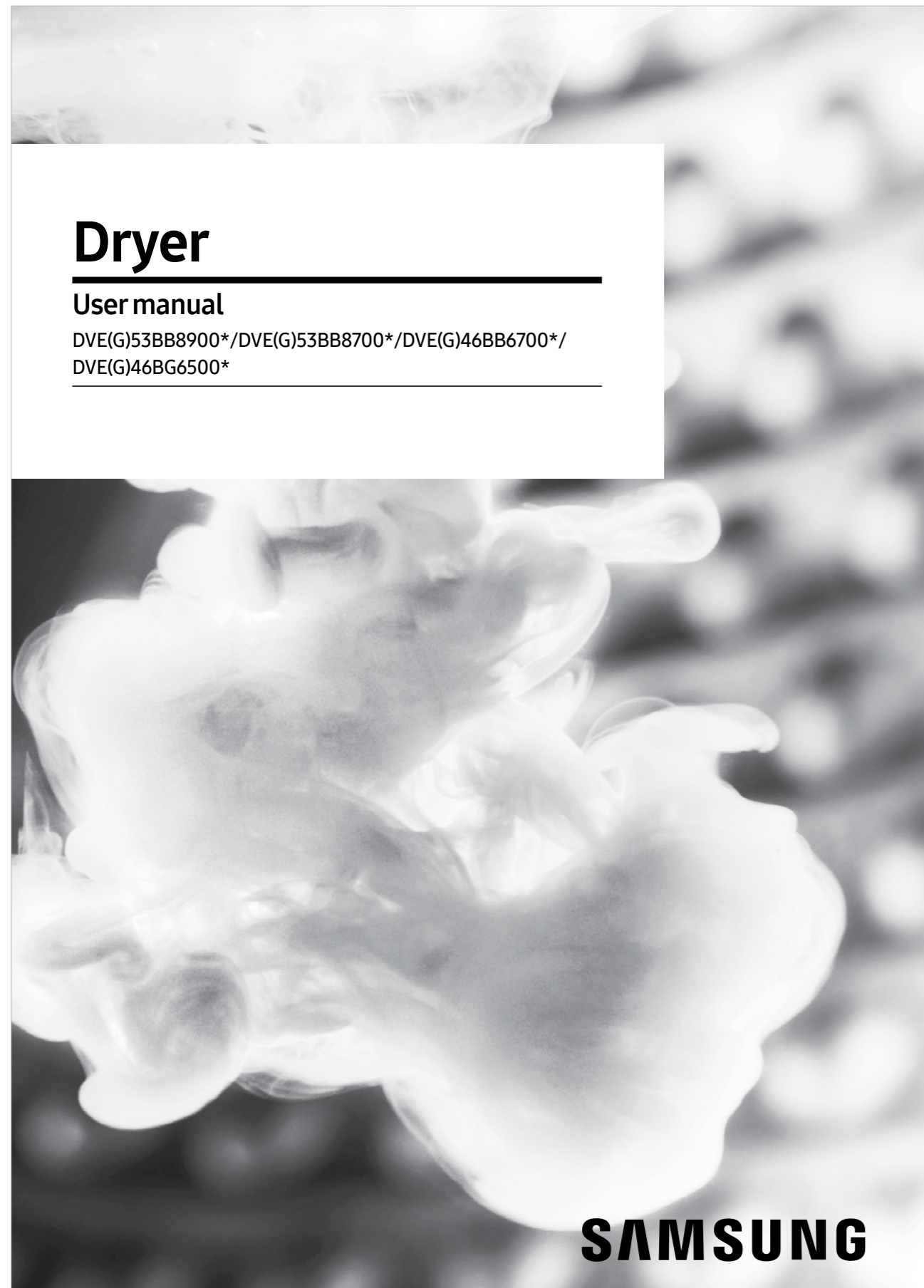

User Manual - Electric and Gas Dryers

LIMITED WARRANTY (U.S.A.) – SAMSUNG DRYER

Models:

DVE(G)53BB8700V

DVE(G)53BB8700T

LIMITED WARRANTY TO ORIGINAL PURCHASER WITH PROOF OF PURCHASE

This SAMSUNG brand product, as supplied and distributed by SAMSUNG ELECTRONICS AMERICA INC. (SAMSUNG) and delivered new, in the original carton to the original consumer purchaser, is warranted by SAMSUNG against manufacturing defects in materials or workmanship for the limited warranty period, starting from the date of original purchase, of:

One (1) Year Parts and Labor

This limited warranty is valid only on products purchased and used in the United States that have been installed, operated, and maintained according to the instructions attached to or furnished with the product. To receive warranty service, the purchaser must contact SAMSUNG at the address or phone number provided below for problem determination and service procedures. Warranty service can only be performed by a SAMSUNG authorized service center. The original dated bill of sale must be presented upon request as proof of purchase to SAMSUNG or SAMSUNG's authorized service center to receive warranty service.

SAMSUNG will provide in-home service within the contiguous United States during the warranty period at no charge, subject to availability of SAMSUNG authorized servicers within the customer's geographic area. If in-home service is not available, SAMSUNG may elect, at its option, to provide transportation of the product to and from an authorized service center. If the product is located in an area where service by a SAMSUNG authorized servicer is not available, you may be responsible for a trip charge or required to bring the product to a SAMSUNG authorized service center for service.

To receive in-home service, product must be unobstructed and accessible to the service agent.

During the applicable warranty period, a product will be repaired, replaced, or the purchase price refunded, at the sole option of SAMSUNG. SAMSUNG may use new or reconditioned parts in repairing a product, or replace the product with a new or reconditioned product. Replacement parts and products are warranted for the remaining portion of the original product's warranty or ninety (90) days, whichever is longer. All replaced parts and products are the property of SAMSUNG and you must return them to SAMSUNG.

Warranty - Electric and Gas Dryers

Feature Icons

DVE53BB8700T / DVG53BB8700T
DVE53BB8700V / DVG53BB8700V

**Bespoke 7.6 cu. ft. Ultra Capacity Electric Dryer
with Super Speed Dry and AI Smart Dial**
**Bespoke 7.6 cu. ft. Ultra Capacity Gas Dryer
with Super Speed Dry and AI Smart Dial**

Feature Icons



Super Speed Dry

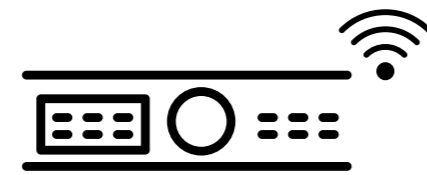

AI Smart Dial



MultiControl™

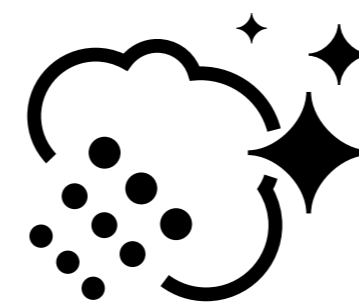

Steam Sanitize+



ENERGY STAR®
Certified

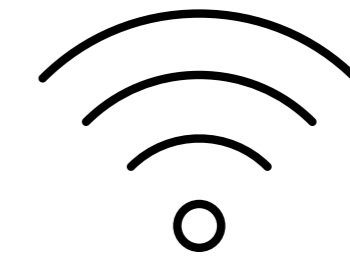

Wi-Fi Connectivity

SAMSUNG