

Wireless Speaker
ULT FIELD 7



Model: YY7858E

Design and specifications are subject to change without notice.

Quick Start Guide

Download the app



By using "Sony | Music Center," you can adjust an equalizer and the sound quality on the speaker connected via a BLUETOOTH® connection. You can also operate and play from various audio sources connected to the speaker. To use all the functions and performance enhancements, use the latest versions of "Sony | Music Center" and the internal software for the speaker. For details, see the following.

<https://www.sony.net/elesupport/>

Let's start to use



1

Turning the power on

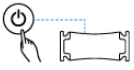

Press the  (power) button. When you use the speaker for the first time after purchase, the speaker automatically enters pairing mode and the  (BLUETOOTH) indicator starts double flashing (pairing mode).

2

Connecting with BLUETOOTH devices



Operate the BLUETOOTH device to perform the pairing procedure and/or to establish a BLUETOOTH connection.

When a BLUETOOTH connection is established, you hear the notification sound from the speaker and the activity of the  (BLUETOOTH) indicator changes from flashing to lit.

3

Listening to music



Start playback on a BLUETOOTH device.

For further functions



Fiestable

By using “Fiestable,” you can enjoy karaoke, add DJ effects along with the music, and flexibly alter the lights on the speakers.*

Install “Fiestable” to your smartphone, etc., from Google Play (Play Store) or from App Store.

* Supported functions vary depending on the model of your speaker.

SRS-ULT70

Getting Started

[Parts and controls](#)

[Carrying/placing the speaker](#)

Power source/charging

[Charging the speaker](#)

[Turning the power on](#)

[Turning the power off](#)

[Using the BLUETOOTH standby \(auto power on\) function](#)

[Charging a USB device such as a smartphone or iPhone](#)

[Auto Standby \(power saving\) function](#)

[Using the speaker with less power consumption of the rechargeable battery \(STAMINA\)](#)

Lighting function

[Turning on/off the speaker's light \(Lighting function\)](#)

Making connections

USB device

[Connecting with a USB device](#)

BLUETOOTH device

[How to make wireless connections to BLUETOOTH devices](#)

[Connecting to BLUETOOTH devices easily with "Sony | Music Center" via a BLUETOOTH connection](#)

[Pairing and connecting with BLUETOOTH devices](#)

[Connecting with a computer via a BLUETOOTH connection \(Windows®\)](#)

[Connecting with a computer via a BLUETOOTH connection \(Mac\)](#)

Multipoint connection

[Connecting the speaker concurrently with 2 BLUETOOTH devices \(multipoint connection\)](#)

Listening to music

USB device

[Listening to music of a USB device](#)

BLUETOOTH device

[Listening to music of a device via a BLUETOOTH connection](#)

[Selecting the quality for music playback via a BLUETOOTH connection \(Codec\)](#)

[Supported codecs](#)

[Terminating the BLUETOOTH connection \(After use\)](#)

[Turning on or off the BLUETOOTH function](#)

[Listening to music of a portable audio device, etc. through a wired connection](#)

[Enjoying switching the sound effects](#)

Stereo Pair function

[Listening to music wirelessly with 2 speakers \(Stereo Pair function\)](#)

Party Connect function

[Enjoying wireless playback using multiple speakers \(Party Connect function\)](#)

Additional features

[Using an external microphone](#)

[Enjoying sound from a guitar](#)

Using “Sony | Music Center”

[What you can do with “Sony | Music Center”](#)

[Installing “Sony | Music Center”](#)

Using “Fiestable”

[What you can do with “Fiestable”](#)

[Installing “Fiestable”](#)

Information

[About the indicators](#)

[Updating the pre-installed software](#)

Notes on use

[Precautions](#)

[Notes on charging](#)

[Notes on waterproof and dustproof features](#)

[How to care for the speaker](#)

[About the BLUETOOTH wireless technology](#)

[Licenses](#)

[Trademarks](#)

Troubleshooting

[What can I do to solve a problem?](#)

Power supply

[Unable to charge the speaker](#)

[Unable to turn on the speaker or the speaker suddenly turns off](#)

Sound

[No sound/Sound from only one speaker/Low sound level/Distorted sound/Humming or noise in the speaker output](#)

[Sound becomes low while in use](#)

USB device

[The USB device is not detected; playback from an audio source fails; no sound comes out of the speaker; playback does not start with the first track](#)

[The sound from the speaker contains noise, skips, or is distorted](#)

[It takes a long time before playback starts](#)

BLUETOOTH device

[Unable to pair the speaker with a BLUETOOTH device](#)

[Speaker output is interrupted](#)

[Unable to connect a BLUETOOTH device with the speaker for the Stereo Pair function](#)

[Unable to connect with a speaker for the Party Connect function](#)

[Unable to add a speaker for the Party Connect function](#)

[Unable to connect the speaker concurrently with 2 devices \(multipoint connection\)](#)

Microphone

[There is no microphone sound](#)

[There is acoustic feedback](#)

Reset

[Restarting the speaker](#)

[Initializing the speaker](#)

Specifications

[Specifications](#)

Wireless Speaker
ULT FIELD 7

Parts and controls

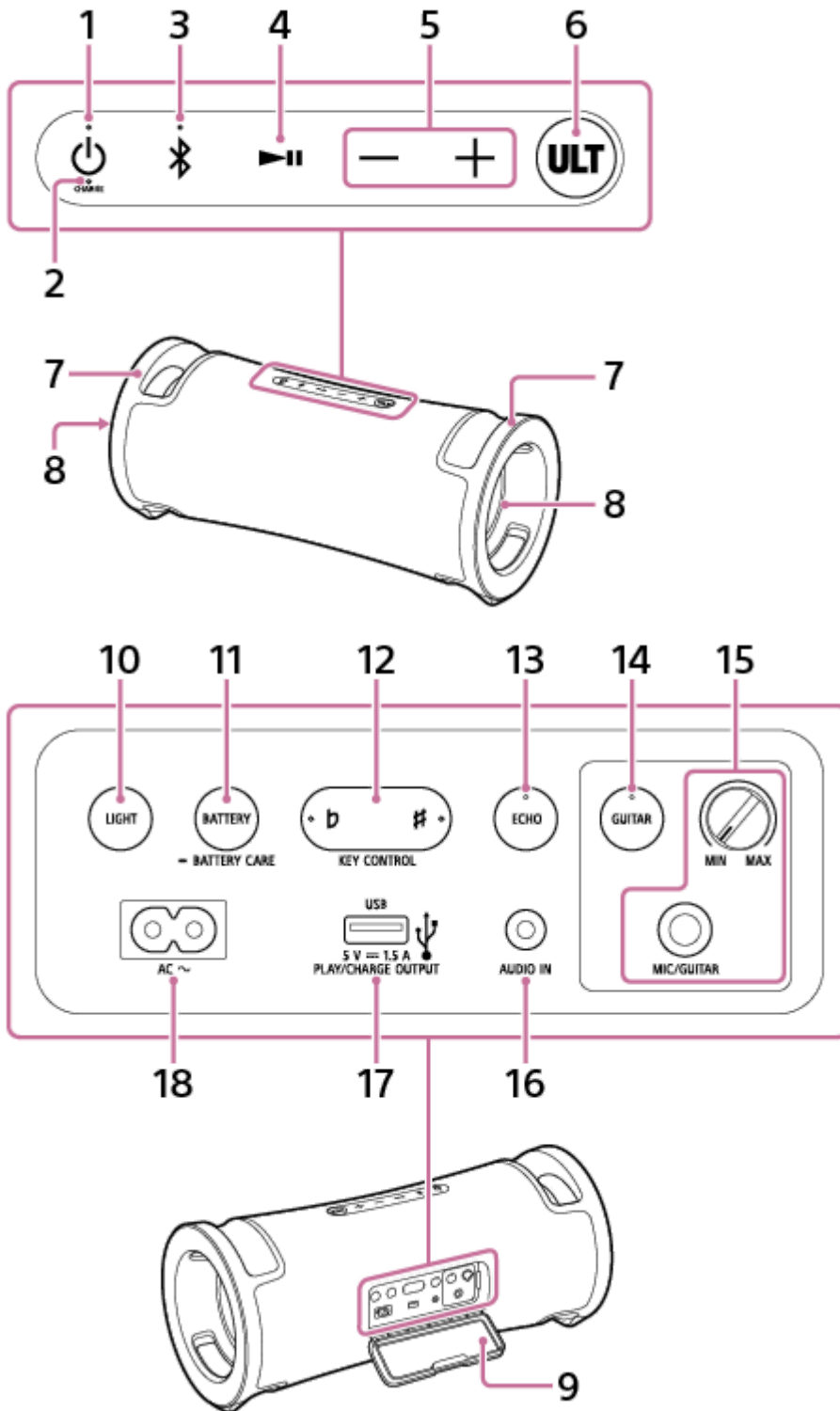

1. ⏻ (power) button with indicator
2. CHARGE indicator
3. 📶 (BLUETOOTH) button with indicator

4. **▶||** (play) button^{*1}
5. **-/+** (volume) buttons
6. **ULT** button
7. **Handles**
8. **Lights**
9. **Cap**
10. **LIGHT** button
11. **BATTERY** button/ **■** **BATTERY CARE** button
12. **KEY CONTROL** **b** (flat) button with indicator/ **#** (sharp) button with indicator
13. **ECHO** button with indicator
14. **GUITAR** button with indicator
15. **MIC and GUITAR level (MIN/MAX) knob**
MIC/GUITAR jack (Φ 6.3 mm)
16. **AUDIO IN** jack (Φ 3.5 mm)^{*2}
17. **PLAY/CHARGE OUTPUT** (DC power output only) port (USB)^{*3}
18. **AC input jack**

^{*1} Pressing and holding **▶||** (play) button for about 5 seconds makes the speaker play the music track stored for demonstration purposes. To disable this feature, press **▶||** (play) button once again.

^{*2} Plugging an audio cable disables audio output from the BLUETOOTH device.

^{*3} Connecting a USB device disables audio outputs from the BLUETOOTH device and the device connected to the AUDIO IN jack.

Note

- The port and jacks on the speaker are not designed for waterproof and dustproof. Do not use the speaker in places where the speaker is likely to have water splashed on it. When you are finished with using the speaker, be sure to securely close the cap.

Related Topic

- [About the indicators](#)

Wireless Speaker
ULT FIELD 7

Carrying/placing the speaker

To carry the speaker

Before carrying the speaker, disconnect all the cables connected to the speaker.

Grasp the left and right handles with both hands, and then lift and move the speaker.

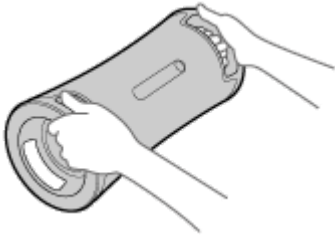

Note

- To avoid personal injuries and/or property damage, place your hands properly on the speaker to hold and carry the speaker.
- Do not let children or infants be near when carrying the speaker.
- If your skin remains in contact with the handle for a long time while the light is turned on, there is a risk of low-temperature burns. To carry a speaker while it is powered on, turn the light (lighting function) off.

To place the speaker in the vertical orientation

The speaker can be placed in the vertical orientation as well.

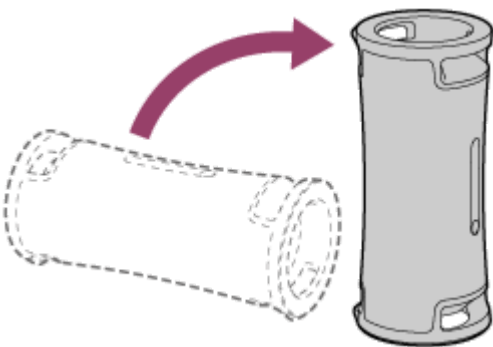

Related Topic

- [Turning on/off the speaker's light \(Lighting function\)](#)

Wireless Speaker
ULT FIELD 7



Charging the speaker

The speaker is capable of running on power either from an AC outlet connected by the supplied AC power cord (mains lead) or from the rechargeable built-in lithium-ion battery.

When using the speaker for the first time, be sure to charge the built-in battery for more than 1 hour before turning on the speaker.

With the built-in battery charged in advance, you can use the speaker solely with battery power.

Hint

- For charging the built-in battery of the speaker, the Battery Care mode option is available in addition to the normal charging method. Battery Care mode limits the maximum charge capacity to approximately 90% and makes the battery life last longer. The playback time available in Battery Care mode is shorter than the time available when the built-in battery is charged by the normal charging method. At the time of purchase, the speaker is not in Battery Care mode.
- While the speaker is turned on, pressing and holding the BATTERY button/  BATTERY CARE button behind the cap on the rear side of the speaker for about 2 seconds places the speaker into Battery Care mode and you hear voice guidance (Battery Care mode, ON) from the speaker. Pressing and holding the BATTERY button/  BATTERY CARE button once again for about 2 seconds brings the speaker out of Battery Care mode and you hear voice guidance (Battery Care mode, OFF) from the speaker.
- You can place/bring the speaker into/out of Battery Care mode with "Sony | Music Center" as well.

1 Connect the speaker to an AC outlet to charge it.

Connect the AC input jack on the speaker and an AC outlet with the supplied AC power cord (mains lead).

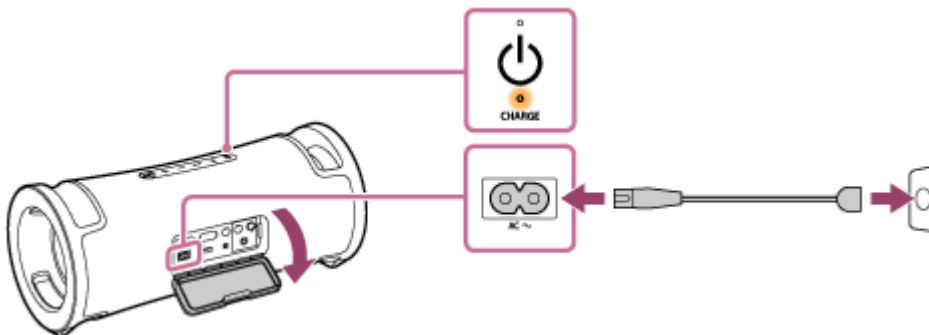

Battery charging starts and the CHARGE indicator lights up in orange. Charging will complete in about 5 hours* and the indicator will turn off.

* Time required for the empty battery to be fully charged (100%) while the speaker is turned off.

After you disconnect the AC power cord (mains lead) from the speaker upon completion of battery charging, be sure to close the cap securely.

The cap plays a very important role in maintenance of the waterproof and dustproof performance.

Checking the charging completion

If the built-in battery is fully charged when you connect the speaker to an AC outlet, the CHARGE indicator lights up in orange then turns off after about 1 minute.

Checking the built-in battery level of the rechargeable built-in battery

After pressing the BATTERY button behind the cap on the rear side of the speaker, when the speaker is turned on, the voice guidance listed below is output from the speaker depending on the remaining built-in battery power.

81% - 100%: "Battery fully charged"

81% - 90% (Battery Care mode): "Battery Care Mode, Fully Charged, Battery About 90%"

61% - 80%: "Battery about 80%"

41% - 60%: "Battery about 60%"

21% - 40%: "Battery about 40%"

1% - 20%: "Low Battery"

Hint

- By using "Sony | Music Center," you can activate/deactivate the voice guidance associated with the remaining battery power that you hear when you turn on the speaker.

Built-in battery life (while the speaker is not in Battery Care mode and a BLUETOOTH connection is established)

- Approx. 30 hours
 - Volume level: 16
 - Sound: ULT1/2 on
 - Lighting: off
- Approx. 25 hours
 - Volume level: 16
 - Sound: ULT1/2 on
 - Lighting: on
- Approx. 3 hours
 - Volume level: 50 (MAX.)
 - Sound: ULT1/2 on
 - Lighting: on

Time required for charging the built-in rechargeable battery (while Battery Care mode is not activated)

- Approx. 5 hours*
10 minutes of charging provide approximately 3 hours of music playback.
(Volume level: 16 / Sound: ULT1/2 on / Lighting: off)

* Time required for the empty battery to be fully charged (100%) while the speaker is turned off.

The built-in battery life above is measured using our specified music source.

Actual performance time may vary from the listed time due to the volume, songs played, surrounding temperature, and usage conditions.

When the built-in battery is running low

When the voice guidance says "Low Battery" and the CHARGE indicator flashes slowly, the built-in battery is running low and needs to be charged. While in this state, the speaker is not capable of supplying power to other devices and may automatically turn off.

When the remaining battery decreases to such a level that the speaker cannot be turned on, you hear voice guidance (Battery is empty.) and the speaker automatically turns off. In such a case, charge the speaker.

In the event that the CHARGE indicator flashes 3 times in orange and then the speaker turns off when the speaker is turned on, the built-in battery is empty and needs to be charged.

Hint

- Turn on STAMINA on “Sony | Music Center” to reduce the power consumed while using the rechargeable built-in battery so you can enjoy playing music for a longer time.

Note



- When you use the speaker at a loud volume, the built-in battery may run low even if the speaker is connected to an AC outlet. If you want to use the speaker while charging, lower the volume of the speaker. Otherwise, turn off the speaker and charge the built-in battery sufficiently.
- The maximum power output will be lower when the built-in battery is running low.
- If the ambient temperature is extremely low or high, the speaker will stop charging the built-in battery for safety reasons. It may also stop charging if charging continues for a long period of time. If such an event occurs, bring the temperature up or down to an operating temperature between 5 °C and 35 °C (41 °F and 95 °F), disconnect and reconnect the supplied AC power cord (mains lead), and then let the speaker charge the built-in battery once again.
- Do not charge the speaker's built-in battery in places where the speaker is likely to have water splashed on it. The supplied AC power cord (mains lead) as well as the jacks and port (AC IN, USB, AUDIO IN, MIC) behind the cap are not designed for waterproof and dustproof.
- Even if you do not intend to use the speaker for a long time, charge the built-in battery sufficiently once every 6 months to maintain its performance.

Related Topic

- [Turning the power on](#)
- [Notes on charging](#)
- [What you can do with “Sony | Music Center”](#)

Turning the power on

1 Press the (power) button.

You hear the notification sound from the speaker, the  (power) indicator lights up in green, and the  (BLUETOOTH) indicator flashes slowly in blue.

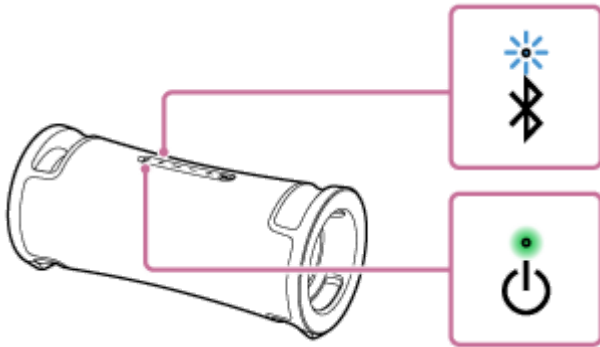

When the speaker has no pairing information, for example when you use the BLUETOOTH function for the first time after purchase, the  (BLUETOOTH) indicator keeps double flashing in blue.

Note



- When the voice guidance says “Low Battery” and the CHARGE indicator flashes slowly, the built-in battery is running low and needs to be charged. While in this state, the speaker is not capable of supplying power to other devices and may automatically turn off.
- When the remaining battery decreases to such a level that the speaker cannot be turned on, you hear voice guidance (Battery is empty.) and the speaker automatically turns off. In such a case, charge the speaker.
- In the event that the CHARGE indicator flashes 3 times in orange and then the speaker turns off when the speaker is turned on, the built-in battery is empty and needs to be charged.

Related Topic

- [Turning the power off](#)
- [Charging the speaker](#)
- [Turning on/off the speaker's light \(Lighting function\)](#)

Turning the power off

1 Press the (power) button.

You hear the notification sound from the speaker, and the  (power) indicator and  (BLUETOOTH) indicator turn off.

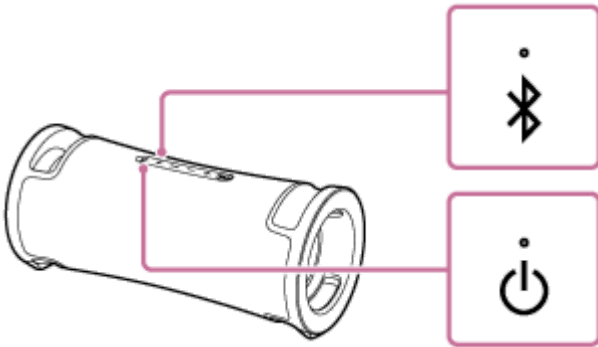

Hint

- While the speaker is connected to an AC outlet by the supplied AC power cord (mains lead) and the BLUETOOTH standby function is activated, turning off the speaker lights the  (power) indicator in orange to indicate the BLUETOOTH standby function is active*.

* At the time of purchase, the BLUETOOTH standby function is deactivated.

Related Topic

- [Auto Standby \(power saving\) function](#)
- [Using the BLUETOOTH standby \(auto power on\) function](#)

Wireless Speaker
ULT FIELD 7

Using the BLUETOOTH standby (auto power on) function

When the BLUETOOTH standby function is activated, the speaker is automatically turned on when you operate a BLUETOOTH device, and starts the BLUETOOTH connection.

Before operating the speaker, note the following:

- The BLUETOOTH standby function is activated only while the speaker is connected to an AC outlet by the supplied AC power cord (mains lead). While the speaker is running only on power from the rechargeable built-in battery, the BLUETOOTH standby function is deactivated.
- Pair the speaker with a BLUETOOTH device in advance. When no pairing information is stored on the speaker, for example when the speaker is used for the first time after purchase, the BLUETOOTH standby function of the speaker is not activated.

1 Turn on the speaker.

You hear the notification sound from the speaker, and the  (power) indicator lights up in green.

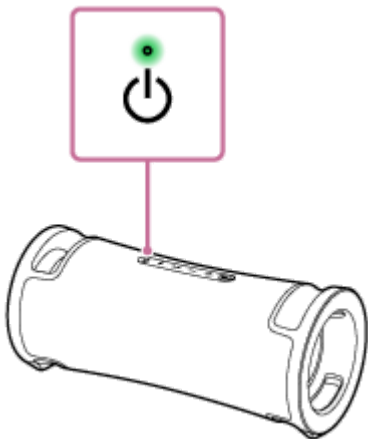

2 Tap [Music Center] on your smartphone, etc. to start up the application.



Music Center

3 Tap [ULT FIELD 7].



4 Tap [Settings].



5 Tap [Power Option].

6 Tap the check box for [Bluetooth Standby] to select the check box.

The selected check box indicates that the BLUETOOTH standby function is activated.

7 Go back to the top screen for the speaker (the screen in step 4).

The change to the settings is put in effect.

To deactivate the BLUETOOTH standby function

In step 6 above, tap the check box for [Bluetooth Standby] to deselect the check box. Going back to the top screen for the selected speaker (the screen in step 4) deactivates the BLUETOOTH standby function.

Hint

- When the BLUETOOTH standby function is activated, the  (power) indicator lights up in orange while the speaker is turned off. (Provided that the speaker is connected to an AC outlet by the supplied AC power cord (mains lead).)

Related Topic

- [Charging the speaker](#)
- [Turning the power on](#)
- [About the indicators](#)

Charging a USB device such as a smartphone or iPhone

You can charge a USB device, such as a smartphone or iPhone, by connecting it to the speaker via USB. Even if the speaker is not connected to an AC outlet, its built-in battery can supply power to a USB device.

- 1 **Connect a USB device, such as a smartphone or an iPhone, to the PLAY/CHARGE OUTPUT port (USB) with a USB cable (commercially available).**

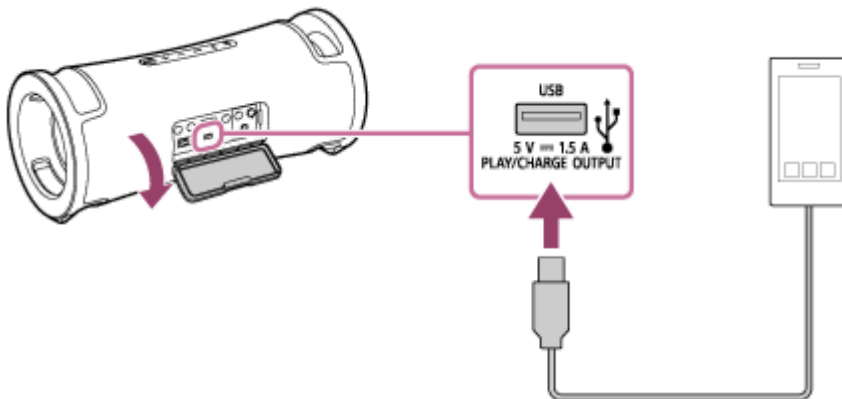

- 2 **Turn on the speaker.**

You hear the notification sound from the speaker, the  (power) indicator lights up in green, and the speaker starts supplying power to the connected USB device for battery charging.

Note

- While the speaker is supplying power to the other device, the Auto Standby function is turned off.
- Turning off the speaker stops power supply to the connected USB device.
- The slowly flashing CHARGE indicator indicates that the built-in battery is running low and needs to be charged. While in this state, the speaker is not capable of supplying power to other devices and may automatically turn off.
- Do not charge the speaker's built-in battery in places where the speaker is likely to have water splashed on it. The supplied AC power cord (mains lead) as well as the jacks and port (AC IN, USB, AUDIO IN, MIC) behind the cap are not designed for waterproof and dustproof.
- After you disconnect the USB cable from the speaker upon completion of battery charging, be sure to close the cap securely. The cap plays a very important role in maintenance of the waterproof and dustproof performance.

Related Topic

- [Charging the speaker](#)
- [Turning the power on](#)
- [Auto Standby \(power saving\) function](#)

Wireless Speaker
ULT FIELD 7

Auto Standby (power saving) function

In the event of the following, the speaker automatically turns off in 15 minutes to conserve the power of the rechargeable built-in battery.

At the time of purchase, the Auto Standby function is set to on.

When the speaker is in BLUETOOTH mode

- No operation on the speaker.
- The connected BLUETOOTH device is not playing music (audio), nor is it being operated.

When the speaker is in AUDIO IN mode

- No operation on the speaker.
- No music (sound) is playing on an audio device connected to the AUDIO IN jack or the music (sound) volume of an audio device connected to the AUDIO IN jack is extremely small.

When the speaker is in USB mode

- No operation on the speaker.
- No music (sound) is playing on a USB device connected to the PLAY/CHARGE OUTPUT port (USB).



Hint

- You can turn on or off the Auto Standby function by using “Sony | Music Center.”

Note

- Disabling this function will increase the power consumption because the product will not turn off automatically when not being used.
- While a microphone or a guitar is connected to the speaker, the Auto Standby function is turned off.
- While the speaker is supplying power to the other device, the Auto Standby function is turned off.

Turning on/off the Auto Standby function

- 1 Turn on the speaker.
- 2 Press and hold **▶||** (play) button and **–** (volume) button simultaneously for about 5 seconds.
 - When the Auto Standby function is turned off, the  (power) indicator flashes 3 times in orange.
 - When the Auto Standby function is turned on, the  (power) indicator flashes twice in orange.

Related Topic

- [What you can do with “Sony | Music Center”](#)

Wireless Speaker
ULT FIELD 7

Using the speaker with less power consumption of the rechargeable battery (STAMINA)

Reduce the power consumed while the speaker is running on the rechargeable built-in battery so you can use the speaker for a longer period of time.

To use STAMINA

At the time of purchase, the STAMINA power option is set to off.

On "Sony | Music Center," tap [ULT FIELD 7] - [Settings] - [Power Option] - [STAMINA], and then set it to on.

While the STAMINA power option is set to on, the lighting function and the sound effects, including the ULT POWER SOUND, are set to off.

Wireless Speaker
ULT FIELD 7

Turning on/off the speaker's light (Lighting function)

The speaker lights up with the music to liven up the atmosphere. When you purchase the speaker, the lighting function is set to on.

1 Turn on the speaker.

You hear the notification sound from the speaker, and the  (power) indicator lights up in green. The speaker lights up.

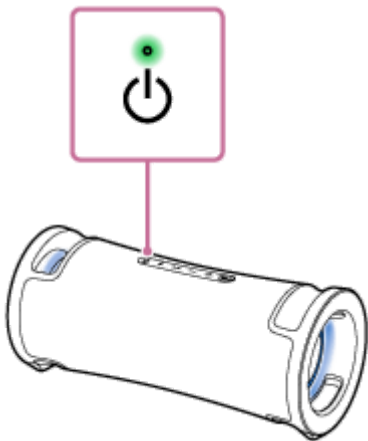

To turn on (light on)/turn off (light off) the lighting function

Press the LIGHT button behind the cap on the rear side of the speaker to turn on/off the lighting function.

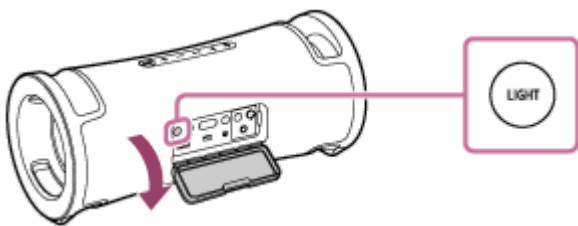

Hint

- By using the "Illumination" function on "Sony | Music Center," you can turn on/off the lighting function or choose the various lighting modes.
- By using the "Illumination" function on "Fiestable," you can change the lighting color of the speaker's light as well.

Note

- When the speaker's light seems bright or glaring, turn up the room lights or turn off the lighting function.
- Be sure to close the cap completely after using the LIGHT button. The cap plays a very important role in maintenance of the waterproof and dustproof performance.

- What you can do with “Sony | Music Center”
- What you can do with “Fiestable”

5-056-532-11(1) Copyright 2024 Sony Corporation

Wireless Speaker
ULT FIELD 7

Connecting with a USB device

Compatible USB devices

- USB devices compliant with USB Mass Storage Class
- USB devices formatted with the FAT (except exFAT) file system

Some USB devices may not work with the speaker even if the devices meet the above conditions.
Using iPhone devices via USB connection is not supported.

Note

- When USB cable connection is necessary, use the USB cable supplied with the USB device. See the operating instructions supplied with the USB device for details on the operation method.
- Do not connect the speaker and the USB device through a USB hub.
- When the USB device is connected, the speaker reads all the files on the USB device. If there are many folders or files on the USB device, it may take a long time to finish reading the USB device.
- With some connected USB devices, there may be a delay before an operation is performed by this speaker.
- Compatibility with all encoding/writing software cannot be guaranteed. If audio files on the USB device were originally encoded with incompatible software, those files may produce noise or interrupted audio, or may not play at all.
- This speaker does not necessarily support all the functions provided in a connected USB device.
- Do not use the PLAY/CHARGE OUTPUT port (USB) in places where the speaker is likely to have water splashed on it. The supplied AC power cord (mains lead) as well as the jacks and port (AC IN, USB, AUDIO IN, MIC) behind the cap are not designed for waterproof and dustproof.

1 Connect a USB device to the PLAY/CHARGE OUTPUT port (USB).

Related Topic

- [Listening to music of a USB device](#)

Wireless Speaker
ULT FIELD 7

How to make wireless connections to BLUETOOTH devices

You can enjoy music with the speaker wirelessly by using your BLUETOOTH device's BLUETOOTH function.

Pairing

Pairing is the process required to mutually register the information on BLUETOOTH devices to be connected wirelessly. To pair with a second or subsequent BLUETOOTH device, perform the following pairing procedure for each device. Pair the speaker and the device manually.

Connecting to a paired device

Once a device is paired, it is not necessary to pair it again. Connect to devices already paired with the speaker using the methods necessary for each device.

For details about pairing and connection operations, see the related topics below.

Related Topic

- [Connecting to BLUETOOTH devices easily with "Sony | Music Center" via a BLUETOOTH connection](#)
- [Pairing and connecting with BLUETOOTH devices](#)
- [Connecting with a computer via a BLUETOOTH connection \(Windows®\)](#)
- [Connecting with a computer via a BLUETOOTH connection \(Mac\)](#)

Wireless Speaker
ULT FIELD 7

Connecting to BLUETOOTH devices easily with “Sony | Music Center” via a BLUETOOTH connection

Launch the “Sony | Music Center” on your Android™ smartphone/iPhone to connect the speaker to a smartphone or iPhone. For details about “Sony | Music Center,” refer to the following URL:

<https://www.sony.net/smcqa/>



Sony Music Center



Note

- The connection with some smartphones and iPhone devices may become unstable when connecting using the “Sony | Music Center.” In that case, follow the procedures in “[Pairing and connecting with BLUETOOTH devices](#)” to connect to the speaker.

Related Topic

- [How to make wireless connections to BLUETOOTH devices](#)
- [Pairing and connecting with BLUETOOTH devices](#)
- [Connecting with a computer via a BLUETOOTH connection \(Windows®\)](#)
- [Connecting with a computer via a BLUETOOTH connection \(Mac\)](#)
- [What you can do with “Sony | Music Center”](#)
- [Installing “Sony | Music Center”](#)

Wireless Speaker
ULT FIELD 7

Pairing and connecting with BLUETOOTH devices

Pairing is the process required to mutually register the information on BLUETOOTH devices to be connected wirelessly. To pair with a second or subsequent BLUETOOTH device, perform the following pairing procedure for each device. The pairing information is stored on the speaker when the speaker is turned off. Before operating the speaker, be sure to do the following:

- Place the BLUETOOTH device within 1 m (3.2 ft) of the speaker.
- Connect the speaker to an AC outlet with the supplied AC power cord (mains lead). Or charge the rechargeable built-in battery sufficiently.
- To avoid any sudden loud sound output from the speaker, turn down the volume of both the BLUETOOTH device and the speaker or stop music playback. Depending on the BLUETOOTH device, the volume of the device may be synchronized with the speaker volume when music playback starts after a BLUETOOTH connection is established between the BLUETOOTH devices and the speaker.
- Prepare the operating instructions supplied with the BLUETOOTH device for reference.

1 Turn on the speaker.

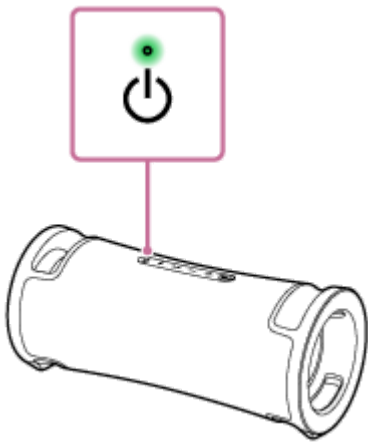

2 Check the status of the (BLUETOOTH) indicator.

When the indicator is double flashing

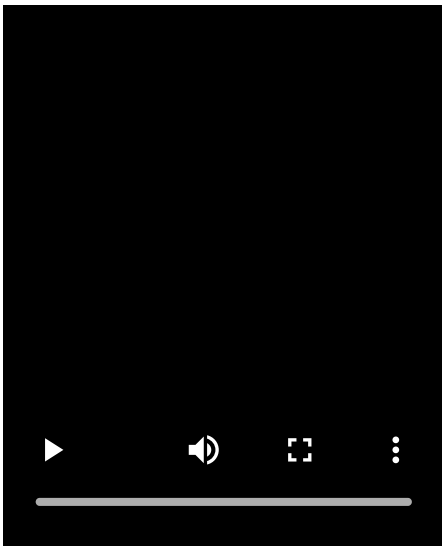

In the event that the speaker is paired with a BLUETOOTH device for the first time after purchase or in the event after the speaker is initialized (the speaker has no pairing information), the speaker automatically enters pairing mode when it is turned on. Proceed to step 4 .

When the indicator is flashing slowly

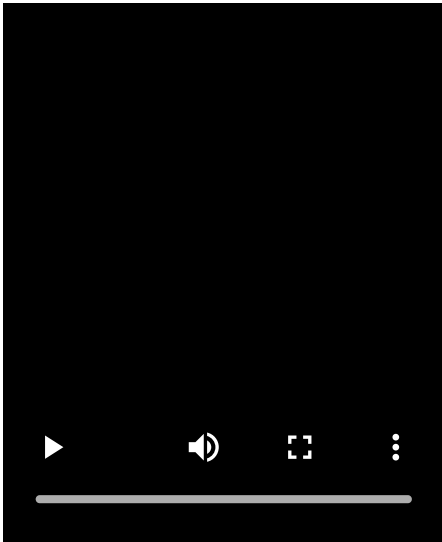

The speaker is searching for BLUETOOTH connections.

- To pair the speaker with a second or subsequent BLUETOOTH device (when the speaker has pairing information of other BLUETOOTH devices), proceed to step 3 .
- To reconnect the speaker with one of the BLUETOOTH devices that have been paired with the speaker before, proceed to step 4 .
The speaker will automatically be connected just by turning on the BLUETOOTH function on the BLUETOOTH device.
Depending on the BLUETOOTH device, the speaker may be reconnected with the device right after it is turned on. For details, refer to the operating instructions supplied with your BLUETOOTH device.

When the indicator stays lit

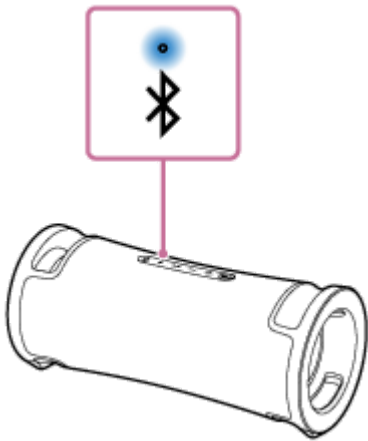

The speaker has been connected to the BLUETOOTH device.

To connect to other BLUETOOTH devices, follow one of the procedures below.

- To pair the speaker with a second or subsequent BLUETOOTH device (when the speaker has pairing information of other BLUETOOTH devices), proceed to step **3**.
- To reconnect the speaker with one of the BLUETOOTH devices that have been paired with the speaker before, proceed to step **4**. The speaker will automatically be connected just by turning on the BLUETOOTH function on the BLUETOOTH device.

3 Press  (BLUETOOTH) button.

You hear voice guidance (Pairing) from the speaker and the  (BLUETOOTH) indicator starts double flashing (pairing mode).

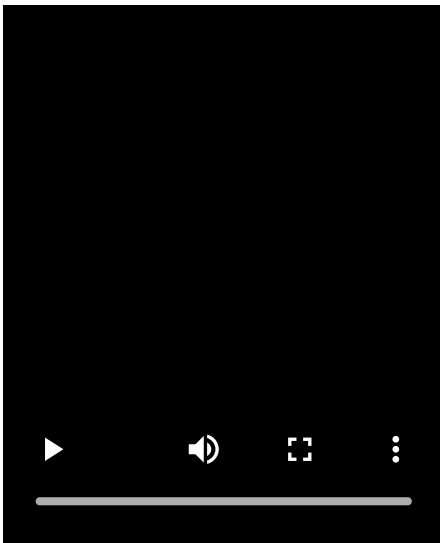

4 Perform the pairing procedure on the BLUETOOTH device to detect the speaker.

When a list of detected devices appears on the display of the BLUETOOTH device, select "ULT FIELD 7."

If a passkey* is required on the display of the BLUETOOTH device, enter "0000."

* The passkey may be called a "passcode," "PIN code," "PIN number," or "password."

5 Establish a BLUETOOTH connection from the BLUETOOTH device.

When a BLUETOOTH connection is established, you hear the notification sound from the speaker and the activity of the  (BLUETOOTH) indicator changes from flashing to lit.

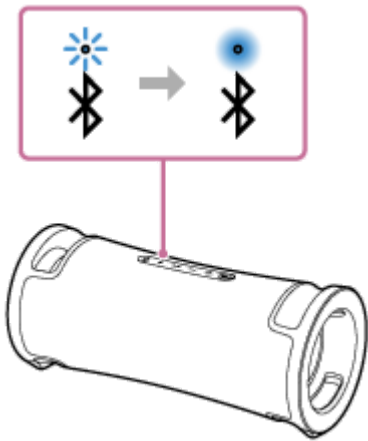

If the BLUETOOTH connection is not established, repeat from step ③.

Hint

- As long as the BLUETOOTH function is activated on a BLUETOOTH device that has previously been connected with the speaker, the speaker is reconnected with the device right after the speaker is turned on.
- The above instructions on the BLUETOOTH device are provided as an example. For details, refer to the operating instructions supplied with the BLUETOOTH device.
- You can perform operations including establishment and disconnection of BLUETOOTH connections by using “Sony | Music Center.”
- You can connect the speaker concurrently with up to 2 BLUETOOTH devices. (Multipoint connection)

Note

- The pairing mode of the speaker is released after about 5 minutes and the  (BLUETOOTH) indicator flashes slowly. However, when the speaker has no pairing information, such as at the factory settings, the pairing mode is not released. If the pairing mode is released before finishing the process, repeat from step ③.
- The passkey of the speaker is “0000.” If a passkey besides “0000” is set on the BLUETOOTH device, pairing cannot be done with the speaker.
- Once BLUETOOTH devices are paired, there is no need to pair them again, except in the following cases:
 - Pairing information has been deleted after repair, etc.
 - The speaker is already paired with 8 devices and another device is to be paired.
The speaker can be paired with up to 8 devices. When a new device is paired in addition to 8 paired devices, the pairing information of the earliest device connected via a BLUETOOTH connection is replaced by the information of the new one.
 - The pairing information of the speaker has been deleted from the BLUETOOTH device.
 - The speaker is initialized.
All pairing information will be deleted. If you initialize the speaker, it may not be able to connect your BLUETOOTH device. In this case, erase the pairing information of the speaker on your BLUETOOTH device, and then perform the pairing procedure again.
- When a USB device or an audio cable is connected to the speaker’s PLAY/CHARGE OUTPUT port (USB) or to the AUDIO IN jack while the speaker is connected to a BLUETOOTH device via a BLUETOOTH connection, sound from the BLUETOOTH device is not output from the speaker. To listen to music from the BLUETOOTH device, disconnect the USB device and the audio cable.
- The speaker can be paired with multiple devices, but can only play music from one paired device at a time.
- When using the Stereo Pair function or the Party Connect function, you cannot use the multipoint connection capability.

Related Topic

- [Connecting the speaker concurrently with 2 BLUETOOTH devices \(multipoint connection\)](#)
- [Listening to music of a device via a BLUETOOTH connection](#)
- [Terminating the BLUETOOTH connection \(After use\)](#)

5-056-532-11(1) Copyright 2024 Sony Corporation

Wireless Speaker
ULT FIELD 7

Connecting with a computer via a BLUETOOTH connection (Windows®)

Pairing is the process required to mutually register the information on BLUETOOTH devices to be connected wirelessly. It is necessary to pair a device with the speaker to be able to make a BLUETOOTH connection for the first time. Perform the same procedures to pair to other devices.

The pairing information is stored on the speaker when the speaker is turned off.

Supported operation systems

Windows 11, Windows 10

Do the following before starting.

- Place your computer within 1 m (3.2 ft) of the speaker.
- Connect the speaker to an AC outlet with the supplied AC power cord (mains lead). Or charge the rechargeable built-in battery sufficiently.
- Prepare the operating instructions supplied with the computer for reference.
- To avoid any sudden loud sound output from the speaker, turn down the volume of both the computer and the speaker or stop music playback.
- Set the speaker of your computer to on.
If the speaker of your computer is set to  (mute), sound does not output on the BLUETOOTH speaker.
 - When the speaker of your computer is set to on:



1 Turn on the speaker.

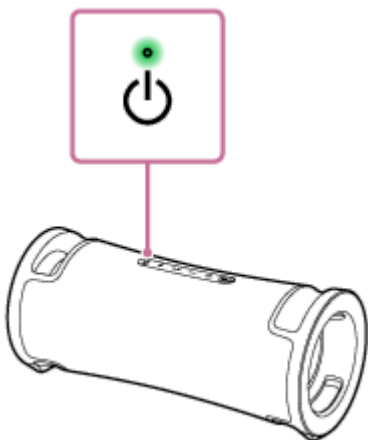

2 Check the (BLUETOOTH) indicator for activity.

When the indicator is double flashing

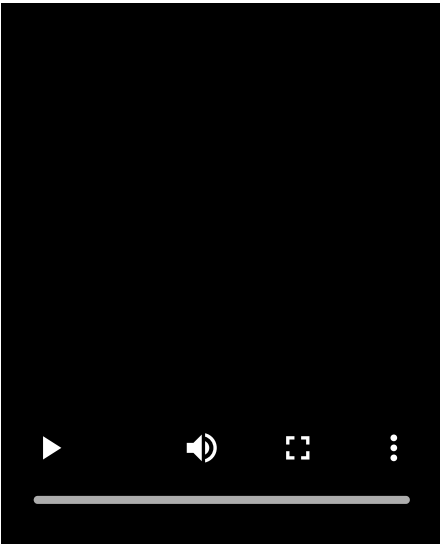

After you pair the speaker with a BLUETOOTH device for the first time since purchase or initialize the speaker (the speaker has no pairing information), the speaker automatically enters pairing mode when it is turned on. Proceed to step 4 .

When the indicator is flashing slowly

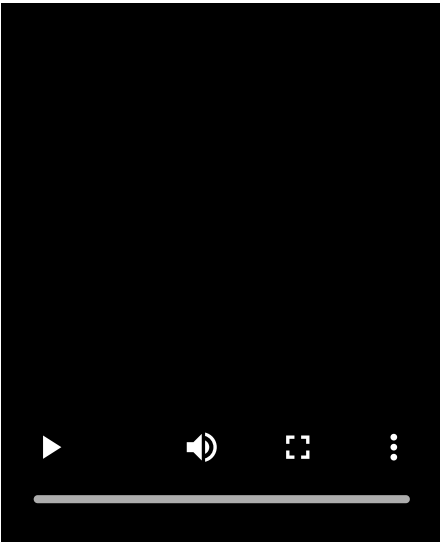

The speaker is searching for BLUETOOTH connections.

- To pair the speaker with a second or subsequent BLUETOOTH device (when the speaker has pairing information of other BLUETOOTH devices), proceed to step 3 .
- To reconnect the speaker with one of the BLUETOOTH devices that have been paired with the speaker before, proceed to step 6 .
The speaker will automatically be connected with the computer just by turning on the BLUETOOTH function on the computer.
Depending on the BLUETOOTH device, the speaker may be reconnected with the device right after it is turned on. For details, refer to the operating instructions supplied with your BLUETOOTH device.

When the indicator stays lit

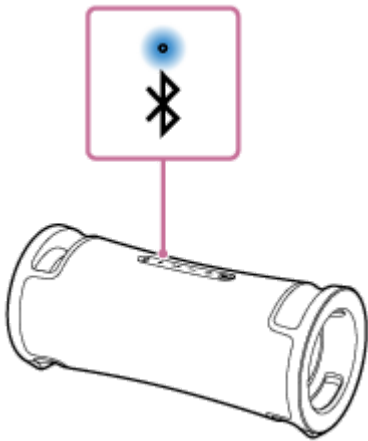

The speaker is already connected with one of the BLUETOOTH devices.

To connect the speaker with another BLUETOOTH device, do either of the following:

- To pair the speaker with a second or subsequent BLUETOOTH device (when the speaker has pairing information of other BLUETOOTH devices), proceed to step **3**.
- To reconnect the speaker with one of the BLUETOOTH devices that have been paired with the speaker before, proceed to step **6**.
The speaker will automatically be connected with the computer just by turning on the BLUETOOTH function on the computer.

3 Press  (BLUETOOTH) button.

You hear voice guidance (Pairing) from the speaker and the  (BLUETOOTH) indicator starts double flashing (pairing mode).

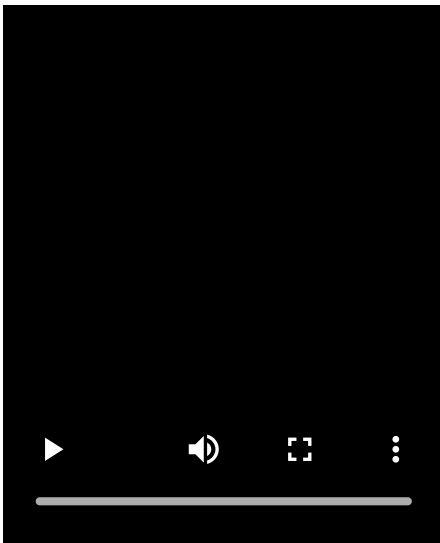

4 Wake the computer up if the computer is in standby (sleep) or hibernation mode.

5 Register the speaker to the computer.

On Windows 11

1. Click the [Start] button, then [Settings].
2. Click [Bluetooth & devices].

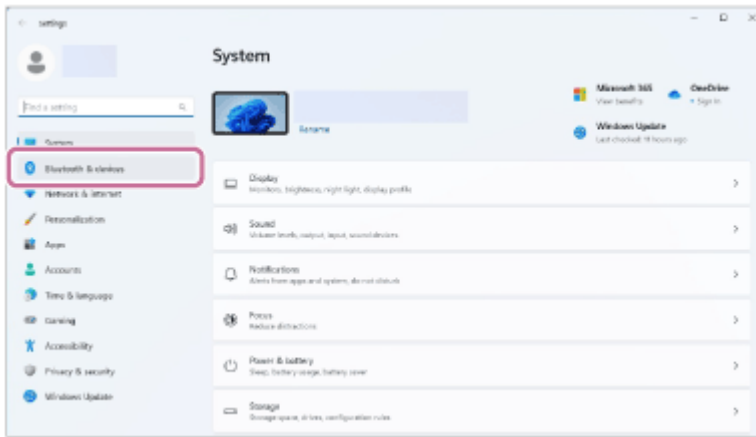

3. Click the [Bluetooth] switch to turn on the BLUETOOTH function, and then click [Add device].



4. Click [Bluetooth].

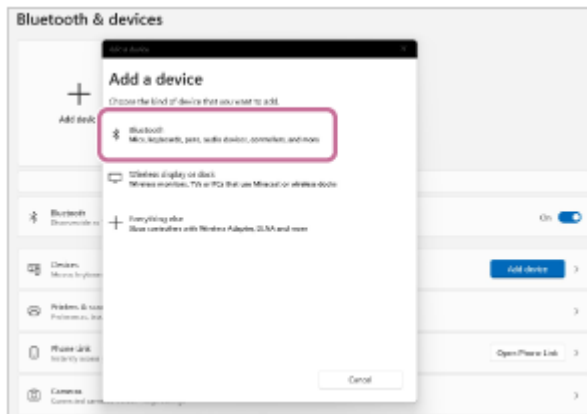

5. Select [ULT FIELD 7].

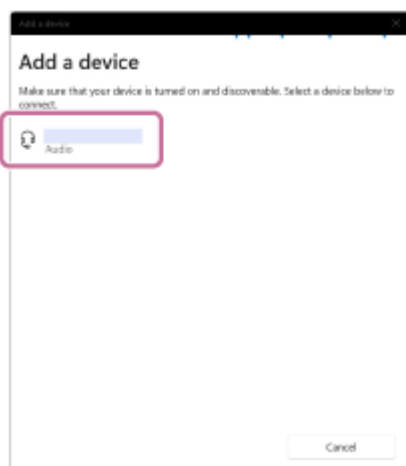

If a passkey* is required, enter "0000."

If [ULT FIELD 7] does not appear, perform the operation again from step 3.

* The passkey may be called a "passcode," "PIN code," "PIN number," or "password."

6. After pairing, the BLUETOOTH connection establishes automatically and [Connected music] or [Connected voice, music] will be displayed on the screen. Proceed to step 7 .



On Windows 10

1. Click the [Start] button, then [Settings].
2. Click [Devices].

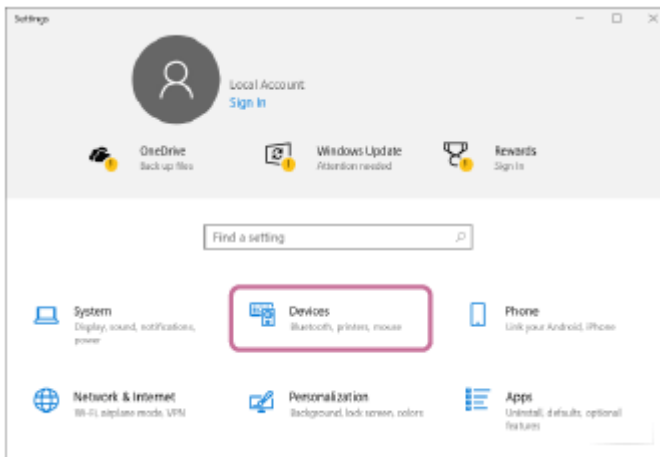

3. Click the [Bluetooth & other devices] tab, click the [Bluetooth] switch to turn on the BLUETOOTH function, and then click [Add Bluetooth or other device].

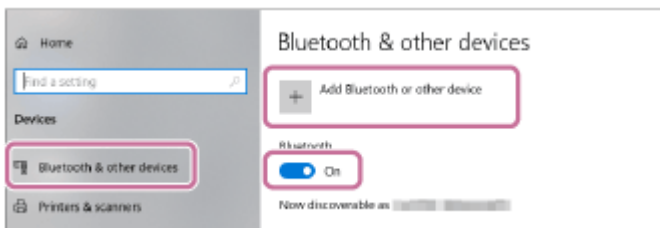

4. Click [Bluetooth].

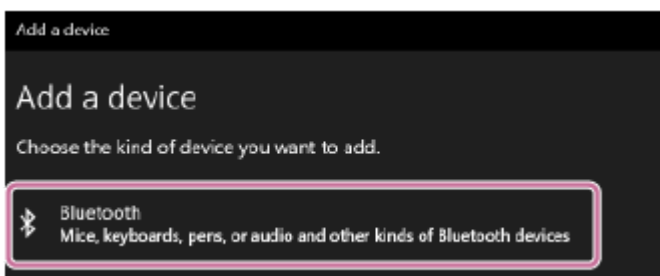

5. Select [ULT FIELD 7].

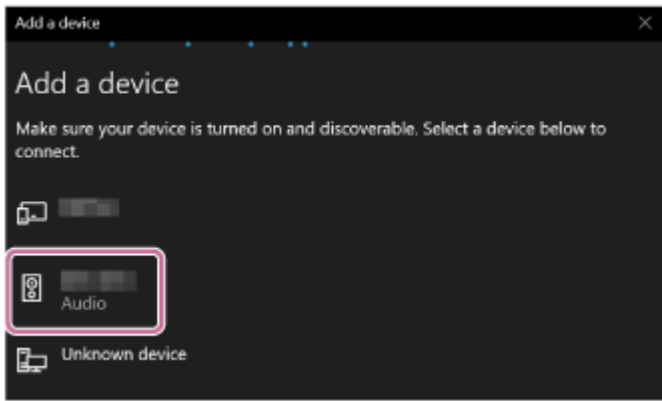

If a passkey* is required, enter "0000."

If [ULT FIELD 7] does not appear, perform the operation again from step 3 .

* The passkey may be called a "passcode," "PIN code," "PIN number," or "password."

6. After pairing, the BLUETOOTH connection establishes automatically and [Connected music] or [Connected voice, music] will be displayed on the screen. Proceed to step 7 .

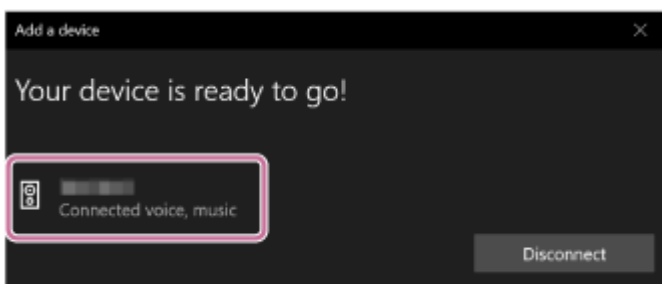

6 Select the speaker on the computer.

On Windows 11

1. Click the [Start] button, then [Settings].
2. Click [Bluetooth & devices].
3. Select [ULT FIELD 7] and click [Connect].

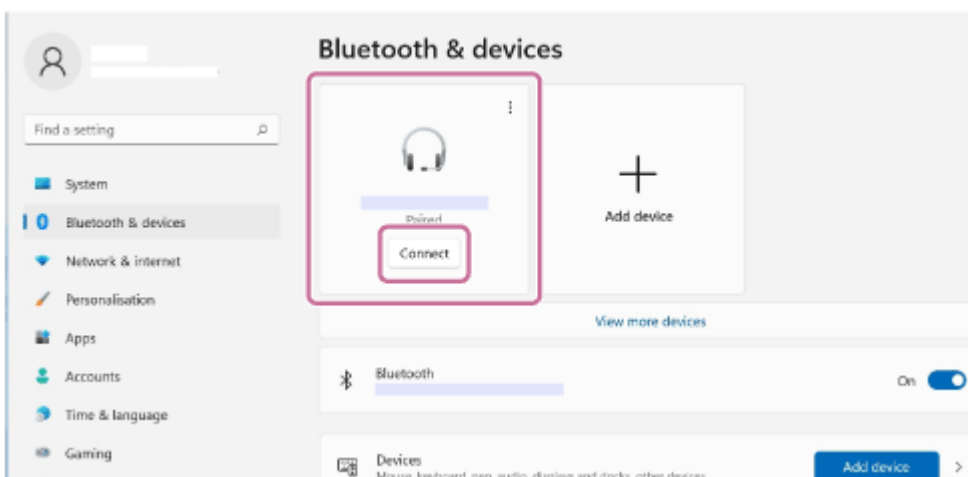

The icon on the screen may look different from what you actually see.

When a BLUETOOTH connection is established, [Connected music] or [Connected voice, music] will be displayed on the screen. Proceed to step 7 .

On Windows 10

1. Click the [Start] button, then [Settings].
2. Click [Devices].

3. Select [ULT FIELD 7] under “Audio” on the [Bluetooth & other devices] tab, and then click [Connect].

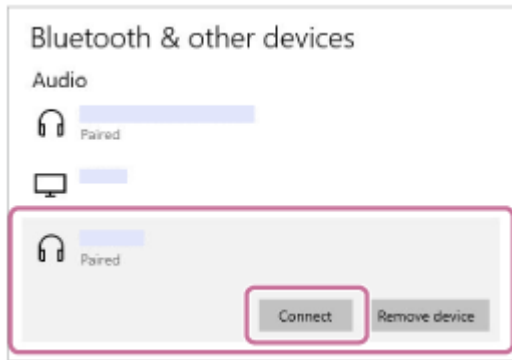

The icon on the screen may look different from what you actually see.

When a BLUETOOTH connection is established, [Connected music] or [Connected voice, music] will be displayed on the screen. Proceed to step 7 .

7 Follow the on-screen instructions to establish a BLUETOOTH connection.

When a BLUETOOTH connection is established, you hear the notification sound from the speaker and the activity of the  (BLUETOOTH) indicator changes from flashing to lit.

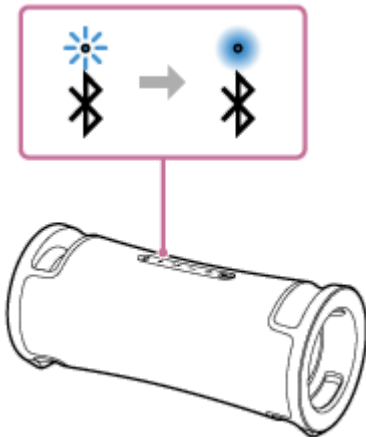

If the connection attempt fails, repeat the procedure from step 3 .

Hint

- The above instructions on the computer are provided as an example. For details, refer to the operating instructions supplied with your computer. In addition, not all the computers are tested and found compatible with the above procedure and the procedure is not applicable to home-built computers.
- You can connect the speaker concurrently with up to 2 BLUETOOTH devices. (Multipoint connection)

Note

- The pairing mode of the speaker is released after about 5 minutes and the  (BLUETOOTH) indicator flashes slowly. However, when the speaker has no pairing information, such as at the factory settings, the pairing mode is not released. If the pairing mode is released before finishing the process, repeat from step 3 .
- Once BLUETOOTH devices are paired, there is no need to pair them again, except in the following cases:
 - Pairing information has been deleted after repair, etc.
 - The speaker is already paired with 8 devices and another device is to be paired.
The speaker can be paired with up to 8 devices. When a new device is paired in addition to 8 paired devices, the pairing information of the earliest device connected via a BLUETOOTH connection is replaced by the information of the new one.

- The pairing information of the speaker has been deleted from the BLUETOOTH device.
- The speaker is initialized.
All pairing information will be deleted. If you initialize the speaker, it may not be able to connect your computer. In this case, erase the pairing information of the speaker on your computer, and then perform the pairing procedure again.
- The speaker can be paired with multiple devices, but can only play music from one paired device at a time.
- The passkey of the speaker is “0000.” If a passkey besides “0000” is set on the BLUETOOTH device, pairing cannot be done with the speaker.
- When a USB device or an audio cable is connected to the speaker’s PLAY/CHARGE OUTPUT port (USB) or to the AUDIO IN jack while the speaker is connected to a BLUETOOTH device via a BLUETOOTH connection, sound from the BLUETOOTH device is not output from the speaker. To listen to music from the BLUETOOTH device, disconnect the USB device and the audio cable.
- When using the Stereo Pair function or the Party Connect function, you cannot use the multipoint connection capability.

Related Topic

- [Connecting the speaker concurrently with 2 BLUETOOTH devices \(multipoint connection\)](#)
- [Listening to music of a device via a BLUETOOTH connection](#)
- [Terminating the BLUETOOTH connection \(After use\)](#)

Wireless Speaker
ULT FIELD 7

Connecting with a computer via a BLUETOOTH connection (Mac)

Pairing is the process required to mutually register the information on BLUETOOTH devices to be connected wirelessly. It is necessary to pair a device with the speaker to be able to make a BLUETOOTH connection for the first time. Perform the same procedures to pair to other devices.

The pairing information is stored on the speaker when the speaker is turned off.

Supported operation systems

macOS Monterey (version 12.6)

Do the following before starting.

- Place your computer within 1 m (3.2 ft) of the speaker.
- Connect the speaker to an AC outlet with the supplied AC power cord (mains lead). Or charge the rechargeable built-in battery sufficiently.
- Prepare the operating instructions supplied with the computer for reference.
- To avoid any sudden loud sound output from the speaker, turn down the volume of both the computer and the speaker or stop music playback.
- Set the speaker of your computer to on.
If the speaker of your computer is set to  (mute), sound does not output on the BLUETOOTH speaker.

– When the speaker of your computer is set to on:



1 Turn on the speaker.

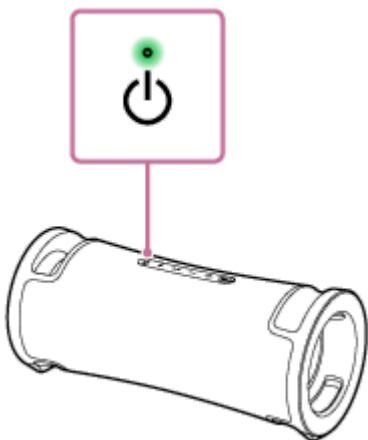

2 Check the (BLUETOOTH) indicator for activity.

When the indicator is double flashing

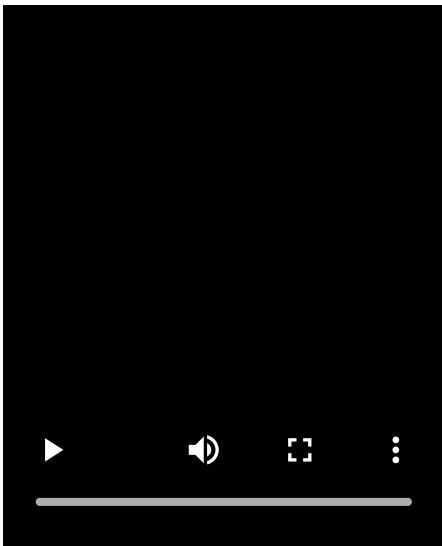

After you pair the speaker with a BLUETOOTH device for the first time since purchase or initialize the speaker (the speaker has no pairing information), the speaker automatically enters pairing mode when it is turned on. Proceed to step 4 .

When the indicator is flashing slowly

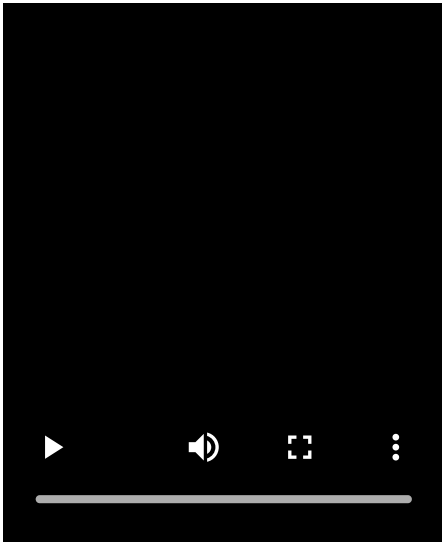

The speaker is searching for BLUETOOTH connections.

- To pair the speaker with a second or subsequent BLUETOOTH device (when the speaker has pairing information of other BLUETOOTH devices), proceed to step 3 .
- To reconnect the speaker with one of the BLUETOOTH devices that have been paired with the speaker before, proceed to step 4 .
The speaker will automatically be connected with the computer just by turning on the BLUETOOTH function on the computer.
Depending on the BLUETOOTH device, the speaker may be reconnected with the device right after it is turned on. For details, refer to the operating instructions supplied with your BLUETOOTH device.

When the indicator stays lit

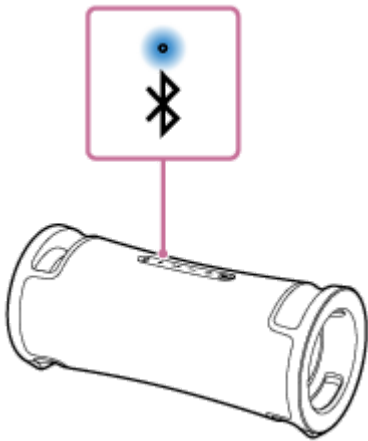

The speaker is already connected with one of the BLUETOOTH devices.

To connect the speaker with another BLUETOOTH device, do either of the following:

- To pair the speaker with a second or subsequent BLUETOOTH device (when the speaker has pairing information of other BLUETOOTH devices), proceed to step **3** .
- To reconnect the speaker with one of the BLUETOOTH devices that have been paired with the speaker before, proceed to step **4** .
The speaker will automatically be connected with the computer just by turning on the BLUETOOTH function on the computer.

3 Press  (BLUETOOTH) button.

You hear voice guidance (Pairing) from the speaker and the  (BLUETOOTH) indicator starts double flashing (pairing mode).

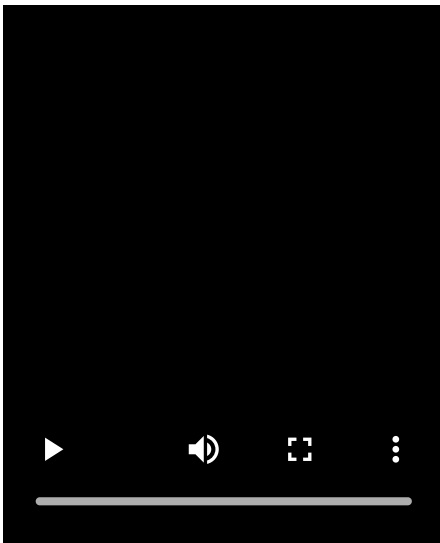

4 Search for the speaker on the computer.

1. Click [ (System Preferences)] - [Bluetooth] in the taskbar on the right-bottom of the screen.



2. Select [ULT FIELD 7] from the Bluetooth screen, then click [Pair].

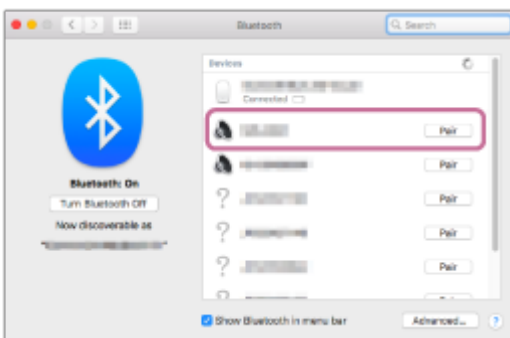

5 Follow the on-screen instructions to establish a BLUETOOTH connection.

When a BLUETOOTH connection is established, you hear the notification sound from the speaker and the activity of the  (BLUETOOTH) indicator changes from flashing to lit.

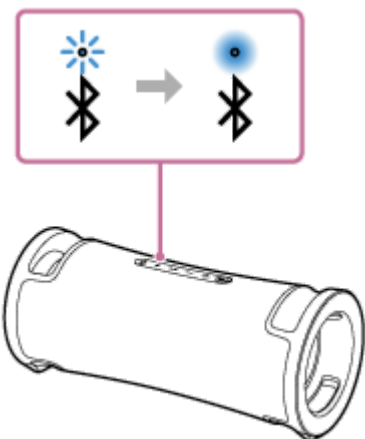

If the connection attempt fails, repeat the procedure from step 3 .

6 Click the speaker icon in the top-right of the screen and select [ULT FIELD 7] from [Output Device].

You can enjoy playing back music, etc. from your computer.

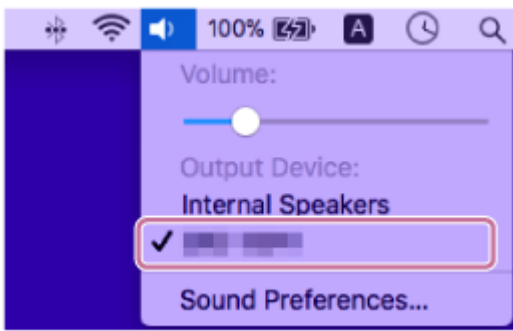

Hint

- The above instructions on the computer are provided as an example. For details, refer to the operating instructions supplied with your computer. In addition, not all the computers are tested and found compatible with the above procedure and the procedure is not applicable to home-built computers.
- You can connect the speaker concurrently with up to 2 BLUETOOTH devices. (Multipoint connection)

Note

- The pairing mode of the speaker is released after about 5 minutes and the  (BLUETOOTH) indicator flashes slowly. However, when the speaker has no pairing information, such as at the factory settings, the pairing mode is not released. If the pairing mode is released before finishing the process, repeat from step ③.
- Once BLUETOOTH devices are paired, there is no need to pair them again, except in the following cases:
 - Pairing information has been deleted after repair, etc.
 - The speaker is already paired with 8 devices and another device is to be paired.
The speaker can be paired with up to 8 devices. When a new device is paired in addition to 8 paired devices, the pairing information of the earliest device connected via a BLUETOOTH connection is replaced by the information of the new one.
 - The pairing information of the speaker has been deleted from the BLUETOOTH device.
 - The speaker is initialized.
All pairing information will be deleted. If you initialize the speaker, it may not be able to connect your computer. In this case, erase the pairing information of the speaker on your computer, and then perform the pairing procedure again.
- The speaker can be paired with multiple devices, but can only play music from one paired device at a time.
- The passkey of the speaker is “0000.” If a passkey besides “0000” is set on the BLUETOOTH device, pairing cannot be done with the speaker.
- When a USB device or an audio cable is connected to the speaker’s PLAY/CHARGE OUTPUT port (USB) or to the AUDIO IN jack while the speaker is connected to a BLUETOOTH device via a BLUETOOTH connection, sound from the BLUETOOTH device is not output from the speaker. To listen to music from the BLUETOOTH device, disconnect the USB device and the audio cable.
- When using the Stereo Pair function or the Party Connect function, you cannot use the multipoint connection capability.

Related Topic

- [Connecting the speaker concurrently with 2 BLUETOOTH devices \(multipoint connection\)](#)
- [Listening to music of a device via a BLUETOOTH connection](#)
- [Terminating the BLUETOOTH connection \(After use\)](#)

Wireless Speaker
ULT FIELD 7



Connecting the speaker concurrently with 2 BLUETOOTH devices (multipoint connection)

While the speaker is connected concurrently with 2 BLUETOOTH devices via BLUETOOTH connections, you can do the following:

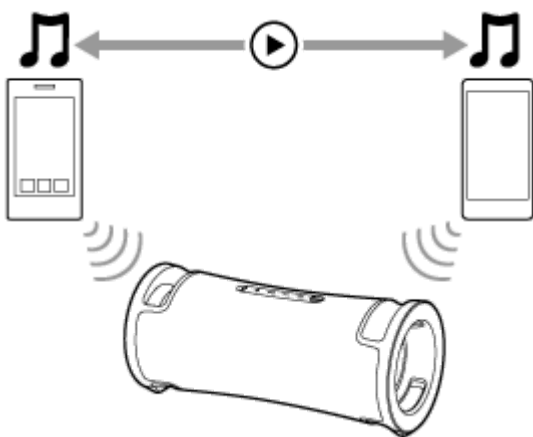
- Switching the music playback source between 2 devices
You can switch the music playback source from one device to the other without reestablishing the BLUETOOTH connection.



Connecting the speaker concurrently with 2 devices via BLUETOOTH connections

- 1 **If a USB device is connected to the PLAY/CHARGE OUTPUT port (USB) or an audio cable is connected to the AUDIO IN jack, disconnect them.**
While a USB device is connected to the PLAY/CHARGE OUTPUT port (USB) or an audio cable is connected to the AUDIO IN jack, you cannot hear music from any BLUETOOTH device.
- 2 **Connect the speaker with the first BLUETOOTH device.**
For details about the BLUETOOTH connection procedure, see one of the following that is applicable to your device.
 - [Connecting to BLUETOOTH devices easily with “Sony | Music Center” via a BLUETOOTH connection](#)
 - [Pairing and connecting with BLUETOOTH devices](#)
 - [Connecting with a computer via a BLUETOOTH connection \(Windows®\)](#)
 - [Connecting with a computer via a BLUETOOTH connection \(Mac\)](#)
- 3 **While keeping the speaker connected with the first BLUETOOTH device, press  (BLUETOOTH) button.**
You hear voice guidance (Pairing) from the speaker and the  (BLUETOOTH) indicator starts double flashing (pairing mode).

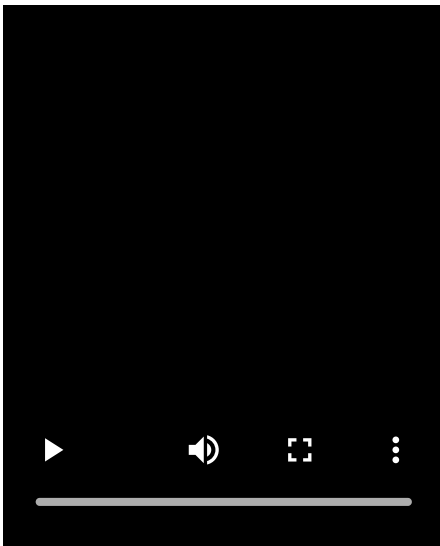

4 Operate the second BLUETOOTH device to search for the speaker.

5 Follow the on-screen instructions to establish a BLUETOOTH connection.

When a BLUETOOTH connection is established, you hear the notification sound from the speaker and the activity of the  (BLUETOOTH) indicator changes from flashing to lit.

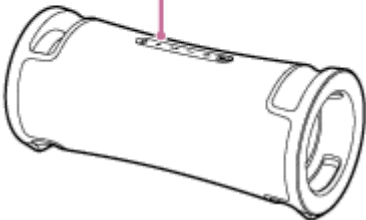
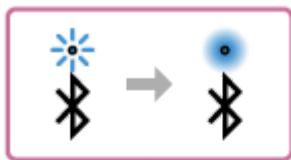

Changing the BLUETOOTH devices in multipoint connection

While keeping the speaker connected with 2 devices in multipoint connection, you can attempt to connect another device via a BLUETOOTH connection.

When you operate the speaker and the third device in an attempt to establish a BLUETOOTH connection, the BLUETOOTH connection with one of the 2 devices used for the previous music playback is retained and the BLUETOOTH connection with the other device is disconnected. Then, a BLUETOOTH connection is established between the speaker and the third device.

Music playback while the speaker is connected with 2 devices in multipoint connection

- When you operate the speaker to play music, music starts playing on one of the devices in multipoint connection that was used for the previous playback.
- To play music on the other (second) device in multipoint connection, operate the second one to start music playback. Depending on the condition, you may still hear music playing on the same (first) device from the speaker after you operate the second device to start playback. In such a case, stop the playback on the first one. Then, you can listen to music playing on the second one.

Hint

- As long as the BLUETOOTH function is activated on a BLUETOOTH device that has previously been connected with the speaker, the speaker is reconnected with the device right after the speaker is turned on.
- You can perform operations including establishment and disconnection of BLUETOOTH connections by using “Sony | Music Center.”

Note

- When using the Stereo Pair function or the Party Connect function, you cannot use the multipoint connection capability.
- Depending on the BLUETOOTH device, you may not be able to use the multipoint connection capability.
- The multipoint connection cannot be disabled.

Related Topic

- [Connecting to BLUETOOTH devices easily with “Sony | Music Center” via a BLUETOOTH connection](#)
- [Pairing and connecting with BLUETOOTH devices](#)
- [Connecting with a computer via a BLUETOOTH connection \(Windows[®]\)](#)
- [Connecting with a computer via a BLUETOOTH connection \(Mac\)](#)

Listening to music of a USB device

The speaker supports the following audio file formats.

- MP3: file extension [.mp3]
- WMA: file extension [.wma]
- WAV: file extension [.wav]

1 Connect a USB device to the PLAY/CHARGE OUTPUT port (USB).

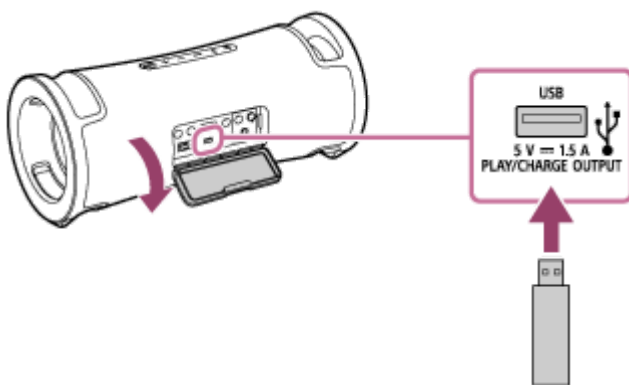

2 Press ►|| (play) button to start playback.

You can use “Sony | Music Center” for playback operations or effortless music selection from the music list on the USB device.

With ►|| (play) button, you can perform the following operations as well.

- Pausing the playback
While playback is in progress, press ►|| (play) button. To restart the playback, press it once again.
- Skipping to the next track
While playback is in progress, press ►|| (play) button twice in a quick succession.
- Skipping to the beginning of the current or previous track
While playback is in progress, press ►|| (play) button 3 times in a quick succession.

3 Press -/+ (volume) buttons to adjust the volume.

Note

- While the Stereo Pair function or the Party Connect function is in use, the speaker is not capable of outputting the music playing on the USB device that is connected to the PLAY/CHARGE OUTPUT port (USB).
- The speaker is unable to play audio files on the USB device in the event of the following:
 - The total number of audio files on the connected USB device exceeds 2 000.
 - The number of folders on the connected USB device exceeds 300, including the “ROOT” folder.

The above figures vary depending on the file and folder structure. On the USB device containing audio files, do not save files of different types or unnecessary folders.

- The speaker is capable of playing audio files contained in up to the 8th level sub-folders.
- Folders containing no audio files are skipped for playback.
- If the actual content of a file with the supported file extension is not what it should be, playing the file may cause the speaker to emit noises or to malfunction.
- While a USB device is connected to the PLAY/CHARGE OUTPUT port (USB), priority is given to the audio output through the USB port and audio outputs from the BLUETOOTH device and the device connected to the AUDIO IN jack are disabled. Depending on the state of the BLUETOOTH connection, the  (BLUETOOTH) indicator lights or flashes in blue. This, however, does not indicate a malfunction.
- While the speaker has a USB device connected, you can still listen to music from the BLUETOOTH device connected via a BLUETOOTH connection or from the device connected to the AUDIO IN jack by selecting, for example, [My Library] on "Sony | Music Center."
- Do not use the PLAY/CHARGE OUTPUT port (USB) in places where the speaker is likely to have water splashed on it. The supplied AC power cord (mains lead) as well as the jacks and port (AC IN, USB, AUDIO IN, MIC) behind the cap are not designed for waterproof and dustproof.

Related Topic

- [Connecting with a USB device](#)

5-056-532-11(1) Copyright 2024 Sony Corporation

Wireless Speaker
ULT FIELD 7

Listening to music of a device via a BLUETOOTH connection

You can enjoy listening to music of a BLUETOOTH device and operate it by the speaker via a BLUETOOTH connection if it supports the following BLUETOOTH profiles.

A2DP (Advanced Audio Distribution Profile)

Enables you to enjoy high-quality audio contents wirelessly.

AVRCP (Audio Video Remote Control Profile)

Enables you to adjust the volume and operate to play, pause or skip to the beginning of the next/current track.

Operations may vary depending on the BLUETOOTH device. Refer also to the operating instructions supplied with the BLUETOOTH device.

Note

- Make sure beforehand that the volume on the BLUETOOTH device and speaker are set to a moderate level to avoid sudden loud sound output from the speaker.
Depending on the BLUETOOTH device, adjusting the volume of the speaker may not be possible on the BLUETOOTH device while playback on the device is stopped/paused.

1 When a USB device or an audio cable is connected to the PLAY/CHARGE OUTPUT port (USB) or to the AUDIO IN jack, disconnect the device or the cable.

While a USB device or an audio cable is connected to the PLAY/CHARGE OUTPUT port (USB) or to the AUDIO IN jack, you do not hear music from any BLUETOOTH device.

2 Connect the speaker with the BLUETOOTH device.

When a BLUETOOTH connection is established, you hear the notification sound from the speaker and the activity of the  (BLUETOOTH) indicator changes from flashing to lit.

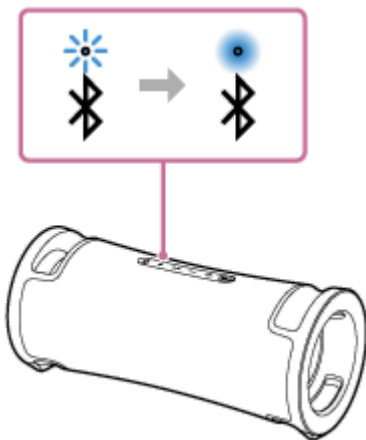

3 Start playback on the BLUETOOTH device.

4 Adjust the volume by pressing **-/+** (volume) buttons or operating the BLUETOOTH device.

When you press **-/+** (volume) buttons or adjust the volume on the BLUETOOTH device, the  (power) indicator flashes once or 3 times.

Depending on the BLUETOOTH device you are using, the  (power) indicator may not flash even if you adjust the volume on the BLUETOOTH device.

Press and hold $-/+$ (volume) buttons for rapid adjustments.

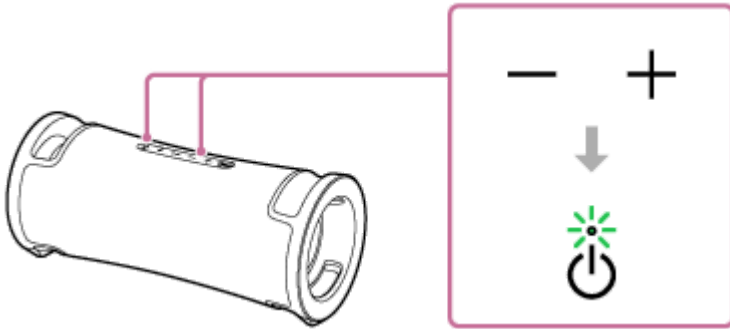

During playback, you can use  (play) button to perform the following operations.

Pause

Press  (play) button during playback to pause. Press it again to cancel pause.

Skip to the beginning of the next track

Press  (play) button twice quickly during playback.



Skip to the beginning of the current or previous track *

Press  (play) button 3 times quickly during playback.

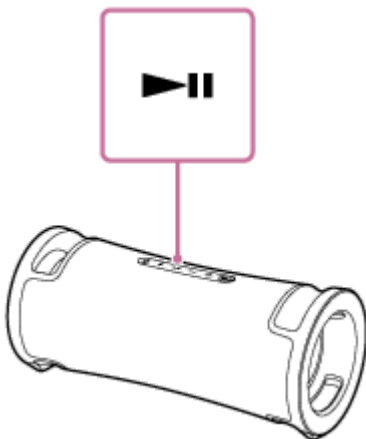
* Operations vary depending on the BLUETOOTH device in use.



Hint

- As long as the speaker is connected to an AC outlet by the AC power cord (mains lead) (supplied), the speaker's built-in battery is capable of charging itself even while music playback from the speaker is in progress. Depending on the usage of the speaker, however, it may take a long time before charging completes. When you intend to use the speaker while charging the battery, turn down the speaker volume, or turn off the speaker and let the battery fully charge itself before using the speaker.
- The speaker supports content protection by the SCMS-T method. You can listen to music (or audio) from the smartphone or mobile phone, which supports the SCMS-T method, through the speaker.
- When you set the volume to the maximum or minimum level on the speaker, the  (power) indicator flashes 3 times.
- Pressing and holding  (play) button for about 5 seconds makes the speaker play the music track stored for demonstration purposes. To disable this feature, press  (play) button once again.

Note

- If the communication condition is poor, the BLUETOOTH device may react incorrectly to the operations on the speaker.

- While music playback is in progress on a BLUETOOTH device, do not connect a device to the PLAY/CHARGE OUTPUT port (USB) or AUDIO IN jack. Connecting a device to the PLAY/CHARGE OUTPUT port (USB) or AUDIO IN jack automatically places the speaker into USB mode or AUDIO IN mode and you cannot hear music from any BLUETOOTH device.
- While the speaker has a device connected to the PLAY/CHARGE OUTPUT port (USB) or AUDIO IN jack, you can still listen to music from a BLUETOOTH device connected via a BLUETOOTH connection by selecting, for example, [My Library] on “Sony | Music Center.”
- When using in a place with a high temperature, the volume may decrease to protect the built-in battery.
- The maximum power output will be lower when the built-in battery is running low.
- Depending on the BLUETOOTH device, it may be necessary to adjust the volume or set the audio output setting on the connected device.
- Noise or sound interruption may occur depending on the BLUETOOTH device connected with the speaker, the communication environment or the usage environment.

Related Topic

- [Terminating the BLUETOOTH connection \(After use\)](#)
- [Charging the speaker](#)

5-056-532-11(1) Copyright 2024 Sony Corporation

Wireless Speaker
ULT FIELD 7**Selecting the quality for music playback via a BLUETOOTH connection (Codec)**

The “Priority on Sound Quality” and “Priority on Stable Connection” preferences are available on the speaker for the BLUETOOTH connection quality. The “Priority on Sound Quality” preference provides compatibility not only with SBC but also with AAC and LDAC for music playback of high sound quality, whereas the “Priority on Stable Connection” preference enables music playback via more stable BLUETOOTH connections. At the time of purchase, the “Priority on Sound Quality” preference is selected.

- Priority on Sound Quality (default setting): Optimal codec is automatically selected from AAC, LDAC, and SBC.
- Priority on Stable Connection: SBC is selected.

1 Turn on the speaker.

You hear the notification sound from the speaker, and the  (BLUETOOTH) indicator flashes* in blue.

* If the BLUETOOTH device that has previously been connected with the speaker is located nearby, the speaker may be connected automatically with the device. In such a case, the  (BLUETOOTH) indicator lights up in blue.

2 Change the BLUETOOTH connection quality.**When using the buttons of the speaker**

1. Press and hold  (play) button and  (BLUETOOTH) button simultaneously for about 2 seconds.

When the setting is changed to the “Priority on Stable Connection” preference, the  (power) indicator flashes 3 times in green.

When the setting is changed to the “Priority on Sound Quality” preference, the  (power) indicator flashes twice in green.

When the speaker is connected with BLUETOOTH devices, all the connections are automatically disconnected and reestablished, and then the preference turns effective.

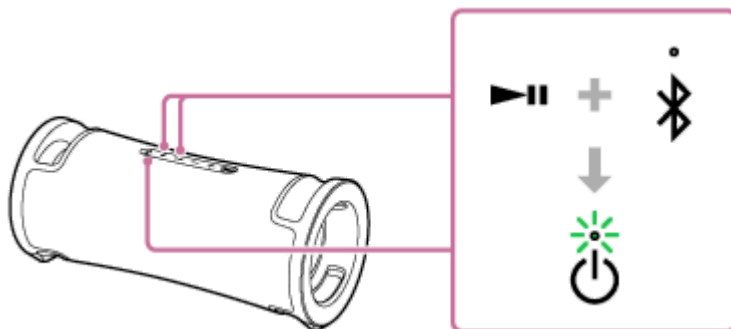
**When using “Sony | Music Center”**

1. Pair the speaker with a BLUETOOTH device, such as a smartphone.
When a BLUETOOTH connection is established, you hear the notification sound from the speaker.
2. Tap [Music Center] on your smartphone, etc. to start up the application.



Music Center

3. Tap [ULT FIELD 7].

4. Tap [Settings] - [Sound] - [Bluetooth Connection Quality], and then select [Priority on Sound Quality] or [Priority on Stable Connection].

All the connections with BLUETOOTH devices are automatically disconnected and reestablished, and then the preference turns effective.

Hint

- When using the Stereo Pair function or the Party Connect function, the codec automatically switches to SBC.

Note

- While the “Priority on Sound Quality” preference is selected, noise or sound interruption may occur depending on the setting of your BLUETOOTH device and ambient conditions. In such a case, change the BLUETOOTH connection quality to the “Priority on Stable Connection” preference.

Related Topic

- [Using the BLUETOOTH standby \(auto power on\) function](#)
- [What you can do with “Sony | Music Center”](#)
- [Supported codecs](#)

Wireless Speaker
ULT FIELD 7

Supported codecs

A codec is an audio coding algorithm used for wirelessly transmitting audio via BLUETOOTH connections.

The speaker supports the following 3 codecs for music playback via an A2DP connection: SBC, AAC, and LDAC™.

- SBC

This is an abbreviation for Subband Codec.

SBC is the standard audio coding technology used by BLUETOOTH devices.

All BLUETOOTH devices support SBC.

- AAC

This is an abbreviation for Advanced Audio Coding.

AAC is mainly used by Apple products such as iPhone that can provide a higher sound quality than that of SBC.

- LDAC

LDAC is an audio coding technology developed by Sony that enables transmission of High-Resolution (Hi-Res) Audio contents, even via BLUETOOTH connections.

Unlike other BLUETOOTH compatible coding technologies such as SBC, it operates without any down-conversion of High-Resolution Audio contents*¹.

It allows approximately 3 times more data*² than those other technologies to be transmitted over a BLUETOOTH wireless network with unprecedented sound quality, employing efficient coding and optimized packetization.

*¹ Excluding DSD format contents.

*² In comparison with SBC when the bitrate of 990 kbps (96/48 kHz) or 909 kbps (88.2/44.1 kHz) is selected.

When music in one of the above codecs is transmitted from a connected device, the speaker switches to that codec automatically and plays back the music in the same codec.

If the connected device supports a codec of higher sound quality than SBC, you may need to set the device beforehand to enjoy music with the desired codec from the supported codecs.

Refer to the operating instructions supplied with the device regarding setting the codec.

Related Topic

- [Selecting the quality for music playback via a BLUETOOTH connection \(Codec\)](#)

Wireless Speaker
ULT FIELD 7

Terminating the BLUETOOTH connection (After use)

When you finish playing music with the BLUETOOTH device, perform any of the following operations to terminate the BLUETOOTH connection.

When the BLUETOOTH connection is disconnected, you hear the notification sound from the speaker.

- Turn off the BLUETOOTH function on the BLUETOOTH device.
For details, refer to the operating instructions supplied with the device.
- Turn off the BLUETOOTH device.
- Turn off the speaker.

Hint

- When using the Stereo Pair function, if you turn off one speaker, the other speaker is automatically turned off. The BLUETOOTH connection between them is disconnected.
- When you finish playing music, the BLUETOOTH connection may terminate automatically depending on the BLUETOOTH device.

Related Topic

- [Turning the power off](#)
- [What you can do with “Sony | Music Center”](#)
- [Auto Standby \(power saving\) function](#)

Wireless Speaker
ULT FIELD 7

Turning on or off the BLUETOOTH function

You can connect to the speaker from a paired BLUETOOTH device when the speaker's BLUETOOTH function is set to on.

At the time of purchase, this setting is set to on.

- 1 Press and hold – (volume) button and  (BLUETOOTH) button for about 5 seconds.

The  (BLUETOOTH) indicator turns off and the BLUETOOTH function is set to off.

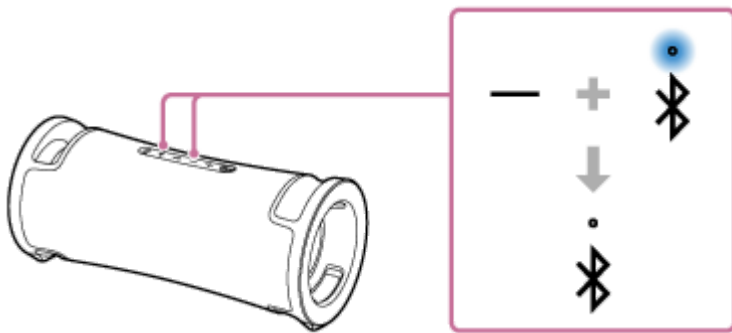

When you press and hold – (volume) button and  (BLUETOOTH) button simultaneously for about 5 seconds once again, the  (BLUETOOTH) indicator flashes and the BLUETOOTH function turns on.

Hint

- With the device previously connected via a BLUETOOTH connection, the speaker is reconnected when its BLUETOOTH function turns on as long as the BLUETOOTH function of the device remains active.

Note

- You cannot perform the following operations when BLUETOOTH function is set to off:
 - Pair and/or connect with BLUETOOTH device.
 - Use “Sony | Music Center.”

Listening to music of a portable audio device, etc. through a wired connection

You can use the speaker by connecting a portable audio device, etc., to the speaker using an audio cable (commercially available).

Note

- Before establishing a connection between the speaker and a portable audio device, turn down the volume of the speaker and the device to avoid any sudden loud sound output from the speaker.

1 When a USB device is connected to the PLAY/CHARGE OUTPUT port (USB), disconnect the device.

While a USB device is connected to the PLAY/CHARGE OUTPUT port (USB), you do not hear music from the device connected to the AUDIO IN jack.

2 Connect a device to the AUDIO IN jack with an audio cable (commercially available).

For connection, use an audio cable with a stereo mini plug (no resistance)* at both ends.

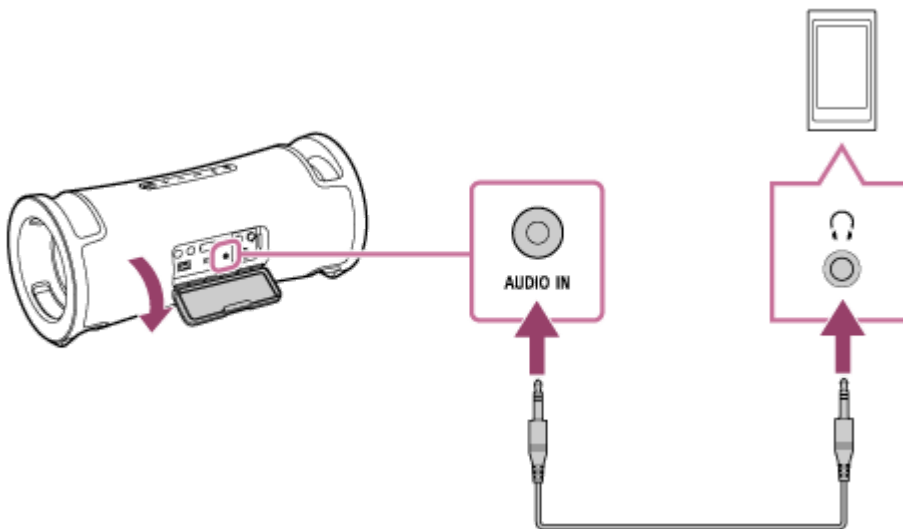

* If you use an audio cable (with stereo mini plugs) with significant resistance, the sound may be lower. Therefore, make sure you use a cable (with stereo mini plugs) without resistance.

3 Turn on the speaker.

You hear the notification sound from the speaker, and the  (power) indicator lights up in green.

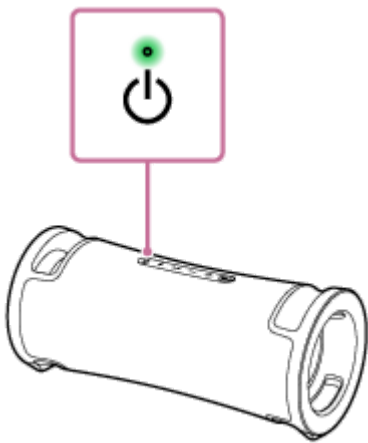

4 Turn on and start playback on the connected device.

5 Adjust the volume to a moderate level on the connected device.

If the volume is adjusted by operations on the connected portable audio device, the  (power) indicator will not flash.

6 Press $-/+$ (volume) buttons to adjust the volume.

When you press $-/+$ (volume) buttons to adjust the volume, the  (power) indicator flashes once or 3 times.

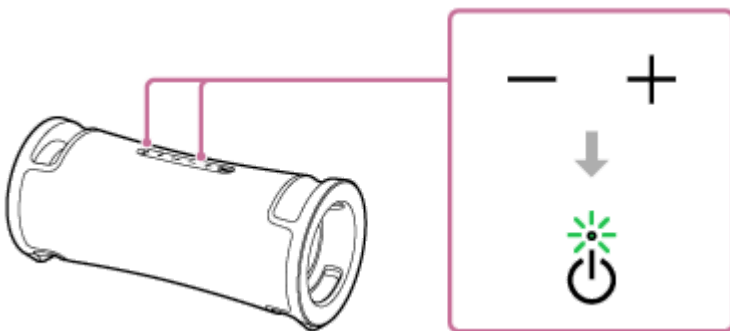

Hint

- When you cannot hear the sound, raise the volume on the connected device.

Note

- While an audio cable is plugged to the AUDIO IN jack, priority is given to the audio output through the AUDIO IN jack and audio output from the BLUETOOTH device is disabled. Depending on the state of the BLUETOOTH connection, the  (BLUETOOTH) indicator lights or flashes in blue. This, however, does not indicate a malfunction.
- While the speaker has an audio cable plugged, you can still listen to music from the BLUETOOTH device connected via a BLUETOOTH connection by selecting, for example, [My Library] on "Sony | Music Center."
- While the Stereo Pair function or the Party Connect function is in use, the speaker is not capable of outputting the music playing on the device that is connected to the AUDIO IN jack by an audio cable.
- While the speaker is in AUDIO IN mode, you can set it up for the Stereo Pair function or the Party Connect function with "Sony | Music Center" as well. Upon completion of the setup, however, the speaker is automatically placed into BLUETOOTH mode.
- When connecting a portable audio device to the AUDIO IN jack and playing music, you cannot use the buttons on the speaker to perform operations such as pause, skip to the beginning of the next track, and skip to the beginning of the current track.

- Do not use the AUDIO IN jack in places where the speaker is likely to have water splashed on it. The supplied AC power cord (mains lead) as well as the jacks and port (AC IN, USB, AUDIO IN, MIC) behind the cap are not designed for waterproof and dustproof.
- Be sure to close the cap completely after disconnecting the audio cable from the speaker. The cap plays a very important role in maintenance of the waterproof and dustproof performance.

Related Topic

- [Auto Standby \(power saving\) function](#)

5-056-532-11(1) Copyright 2024 Sony Corporation

Wireless Speaker ULT FIELD 7

Enjoying switching the sound effects

You can enjoy switching the sound effects on the speaker.

Enjoying enhanced deep bass sound (ULT button)

You can take either of the following procedures for setup. At the time of purchase, the ULT POWER SOUND setting is turned on.

- Press the ULT button.
Each time you press the ULT button, the setting switches from ULT1, ULT2, and off.
Each time the setting is changed, you hear the notification sound from the speaker, and the ULT button lights up or lights out.

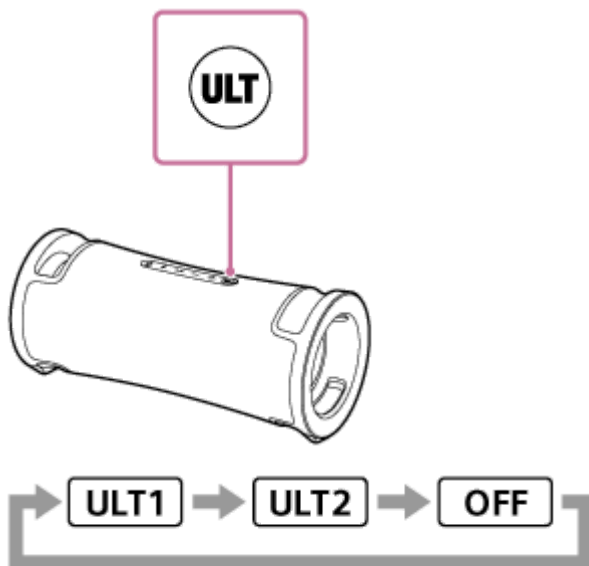



ULT1: Emphasizes deep bass sound.

ULT2: Emphasizes the sense of power even more than ULT1.

Off: Turns off the ULT POWER SOUND setting.

- Use “Sony | Music Center.”
On “Sony | Music Center,” tap [ULT FIELD 7] - [Settings] - [Sound] - [Sound Effect], then select one of [OFF], [ULT1], or [ULT2].

Hint

- The default setting (ULT1 or ULT2) varies depending on the country or region.
- By pressing and holding the ULT button and the – (volume) button on the speaker simultaneously for about 2 seconds, you can turn on or off the notification sound.
When the notification sound is turned off, the  (power) indicator flashes 3 times in green.
When the notification sound is turned on, the  (power) indicator flashes twice in green.

Adjusting the equalizer setting to your preference (CUSTOM)

On “Sony | Music Center,” tap [ULT FIELD 7] - [Settings] - [Sound] - [Sound Effect] - [CUSTOM].
Tap [Custom EQ], and then adjust the equalizer setting to suit your preference.

Automatically adjusting to the optimal sound according to the environment (Sound Field Optimization)

This proprietary microphone sensing technology detects noises around the speaker while playing music to automatically make adjustments to optimize sound. At the time of purchase, Sound Field Optimization is set to on.

To set Sound Field Optimization to on

On “Sony | Music Center,” tap [ULT FIELD 7] - [Settings] - [Sound] - [Sound Field Optimization], and then set it to on.

Note

- In some cases, the surrounding noise may prevent the sound from being optimized.
- When using the Stereo Pair function or the Party Connect function, the setting for Sound Field Optimization is turned off.

Wireless Speaker
ULT FIELD 7

Listening to music wirelessly with 2 speakers (Stereo Pair function)

To use the Stereo Pair function, 2 ULT FIELD 7 speakers are required. By connecting 2 speakers via a BLUETOOTH connection, you can enjoy more powerful sound.

2 speakers connected via a BLUETOOTH connection play sounds in stereo, where 1 speaker plays the sound on the right channel (right side) and the other plays the sound on the left channel (left side).

Before operating the speaker, make sure of the following:

- Update the pre-installed software to the latest version on each and every speaker to connect for the function. (For details about the update procedure, see [Updating the pre-installed software](#).)
- When setting up the speakers for the Stereo Pair function, make sure that the 2 speakers to connect for the function are located within 1 m (3.2 ft) from each other. Stop music playback if it is in progress.
- When playing music, make sure that all of the devices to connect for the function are located within 30 m (98.4 ft) in your line of sight.

Maximum communication range may shorten under the following conditions.

- There is an obstacle such as a person, metal, or wall between the speaker and BLUETOOTH device.
- A wireless LAN device is in use near the speaker.
- A microwave oven is in use near the speaker.
- A device that generates electromagnetic radiation is in use near the speaker.

1 Use “Sony | Music Center” to set up the speaker for the Stereo Pair function.

For details about “Sony | Music Center,” refer to the following URL:

<https://www.sony.net/smcqa/>

To terminate the Stereo Pair function

Use “Sony | Music Center.”

Hint

- Use of the Stereo Pair function automatically switches the codec to SBC.
- Turning off the speakers does not turn off the Stereo Pair function. When one of the speakers is turned back on, it attempts to establish a connection for the Stereo Pair function. To use the Stereo Pair function, turn on the other speaker within 1 minute. When the BLUETOOTH standby function remains active* on both of the speakers, however, turning on either of the speakers automatically turns on the other and establish a connection for the Stereo Pair function between the speakers.

* The BLUETOOTH standby function is activated only while the speaker is connected to an AC outlet by the supplied AC power cord (mains lead).

Note

- While the Stereo Pair function is in use, the speaker is not capable of outputting the music playing on the USB device that is connected to the PLAY/CHARGE OUTPUT port (USB) or on the device that is connected to the AUDIO IN jack by an audio cable.
- While the speaker is in AUDIO IN or USB mode, you can set it up for the Stereo Pair function with “Sony | Music Center” as well. Upon completion of the setup, however, the speaker is automatically placed into BLUETOOTH mode.

- Deactivating the Stereo Pair function gives no effect on the established BLUETOOTH connection and the speaker remains in BLUETOOTH mode.
- To avoid any sudden loud sound output from the speaker, turn down the volume of the speaker and a BLUETOOTH device or stop the playback on the BLUETOOTH device before establishing a connection with the BLUETOOTH device.

Related Topic

- [Using the BLUETOOTH standby \(auto power on\) function](#)
- [Installing “Sony | Music Center”](#)
- [Updating the pre-installed software](#)

5-056-532-11(1) Copyright 2024 Sony Corporation

Wireless Speaker
ULT FIELD 7

Enjoying wireless playback using multiple speakers (Party Connect function)

You can connect multiple speakers (up to 100 speakers) compatible with the Party Connect function via BLUETOOTH connections and enjoy music playback.

Devices compatible with the Wireless Party Chain function are not applicable for connection.

Devices* compatible with the Party Connect function:

LSPX-S3, SRS-XP700, SRS-XP500, SRS-XG500, SRS-XG300, SRS-XB43, SRS-XB33, SRS-XB23, SRS-XE300, SRS-XE200, SRS-XV900, SRS-XV800, SRS-XV500, SRS-ULT70, SRS-ULT1000

* Depending on your country or region, some of the compatible devices are not available for purchase.

Before operating the speaker, make sure of the following:

- Update the pre-installed software to the latest version on each and every speaker to connect for the function. (For details about the update procedure, see [Updating the pre-installed software.](#))
- When setting up the speakers for the Party Connect function, make sure that all of the speakers to connect for the function are located within 1 m (3.2 ft). Stop music playback if it is in progress.
- When playing music, make sure that all of the devices to connect for the function are located within 30 m (98.4 ft) in your line of sight.

Maximum communication range may shorten under the following conditions.

- There is an obstacle such as a person, metal, or wall between the speaker and BLUETOOTH device.
- A wireless LAN device is in use near the speaker.
- A microwave oven is in use near the speaker.
- A device that generates electromagnetic radiation is in use near the speaker.

1 Use “Sony | Music Center” to set up the speaker for the Party Connect function.

For details about “Sony | Music Center,” refer to the following URL:

<https://www.sony.net/smcqa/>

2 Start playback on the BLUETOOTH device, and adjust the volume to moderate level.

The same music is played from all speakers.

When adjusting the volume on the BLUETOOTH device or the speaker connected with the device (the speaker set up as the first one), the volumes of all speakers are automatically adjusted. For other speakers (the second or later speaker set), you can also adjust the volume on each other.

To change the connected BLUETOOTH device or speaker or to terminate the Party Connect function

Stop music playback in advance.

Hint

- The lights and ULT button on the speaker light up differently depending on the model that is set up as the first speaker.
- When using the Party Connect function, the codec automatically switches to SBC.

Note

- While the Party Connect function is in use, the speaker is not capable of outputting the music playing on the USB device that is connected to the PLAY/CHARGE OUTPUT port (USB) or on the device that is connected to the AUDIO IN jack by an audio cable.
- While the speaker is in AUDIO IN or USB mode, you can set it up for the Party Connect function with “Sony | Music Center” as well. Upon completion of the setup, however, the speaker is automatically placed into BLUETOOTH mode.
- Deactivating the Party Connect function gives no effect on the established BLUETOOTH connection and the speaker remains in BLUETOOTH mode.
- When watching movies using the Party Connect function, there may be a gap between video and audio.

Related Topic

- [Installing “Sony | Music Center”](#)
- [Updating the pre-installed software](#)

5-056-532-11(1) Copyright 2024 Sony Corporation

Using an external microphone

You can output your voice from the speaker by connecting a dynamic microphone with a normal plug (Φ 6.3 mm) (commercially available).

- 1 Turn the MIC and GUITAR level knob to MIN to reduce the microphone volume level.

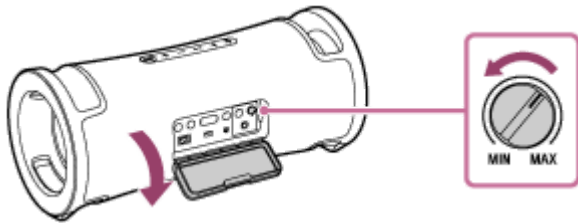

- 2 Connect an external microphone to the MIC/GUITAR jack.

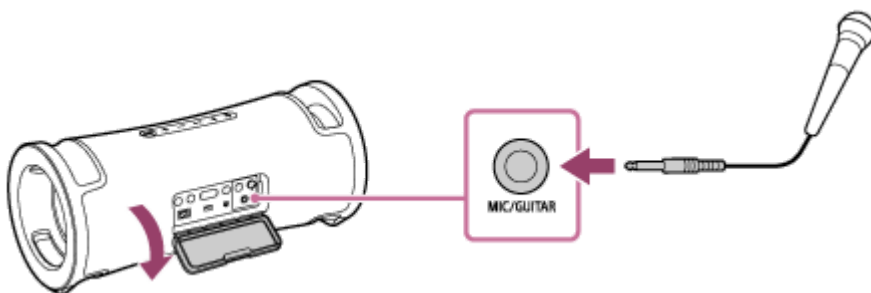

- 3 Adjust the volume using the MIC and GUITAR level knob.

- 4 Speak or sing into the connected microphone.

With the buttons behind the cap on the rear side of the speaker, you can perform the following operations as well.

Key Control

You can change the key of a song you sing.

Press KEY CONTROL **b** (flat) button/ **#** (sharp) button to adjust the key to suit your vocal range.

Mic Echo

You can add the echo effect to your voice when you sing into the microphone.

Press ECHO button repeatedly to adjust the echo effect.

Note

- When using the Party Connect or Stereo Pair function, sound from the microphone is only output from the speaker to which the microphone is connected.
- Bringing the microphone close to the speaker may cause acoustic feedback. When this happens, depending on the sound volume of the speaker, the speaker may turn off due to the product protection feature. In that case, disconnect the AC power cord (mains lead), wait for a while, and then turn on the speaker again.
- While a microphone or a guitar is connected to the speaker, the Auto Standby function is turned off.

- Do not use the MIC/GUITAR jack in places where the speaker is likely to have water splashed on it. The supplied AC power cord (mains lead) as well as the jacks and port (AC IN, USB, AUDIO IN, MIC) behind the cap are not designed for waterproof and dustproof.

Related Topic

- [There is acoustic feedback](#)

5-056-532-11(1) Copyright 2024 Sony Corporation

Enjoying sound from a guitar

You can listen to sound from your guitar by connecting it to the MIC/GUITAR jack (Φ 6.3 mm) on the speaker.

- 1 Turn the MIC and GUITAR level knob toward MIN to turn down the guitar volume.

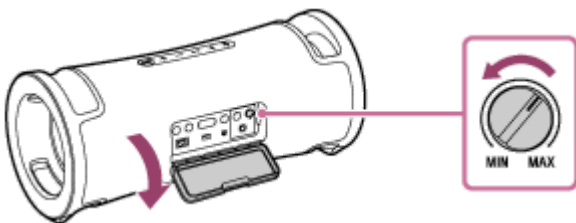

- 2 Connect the guitar to the MIC/GUITAR jack with an instrument cable for guitar wiring (commercially available).

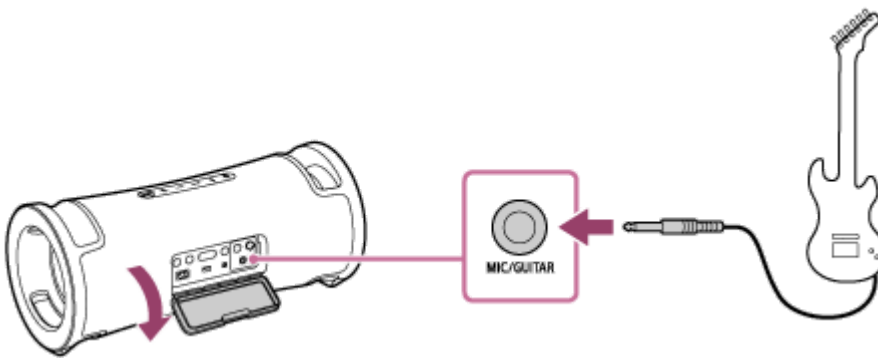

- 3 Press the GUITAR button behind the cap on the rear side of the speaker.

The GUITAR indicator lights in white.

- 4 Adjust the guitar volume while playing the guitar.

The guitar sound is output from the speaker.

To bring the speaker out of guitar mode

Press the GUITAR button once again.

Note

- Before disconnecting the guitar from the speaker, turn the MIC and GUITAR level knob toward "MIN" to turn down the guitar volume.
- While a microphone or a guitar is connected to the speaker, the Auto Standby function is turned off.
- Do not use the MIC/GUITAR jack in places where the speaker is likely to have water splashed on it. The supplied AC power cord (mains lead) as well as the jacks and port (AC IN, USB, AUDIO IN, MIC) behind the cap are not designed for waterproof and dustproof.

Wireless Speaker
ULT FIELD 7

What you can do with “Sony | Music Center”

“Sony | Music Center” is an app for controlling Sony audio devices which are compatible with “Sony | Music Center” using your smartphone, etc.

For details about “Sony | Music Center,” refer to the following URL:

<https://www.sony.net/smcqa/>

Operations that can be performed on a speaker with “Sony | Music Center”

- Setting up the Party Connect function
- Setting up the Stereo Pair function, swapping the right (right side) and left (left side) audio channels
- Sound quality setting and equalizer adjustment
- Built-in battery level indication
- Power Option settings (STAMINA, Battery Care, Battery Level (Voice), Power On/Off Sound, Auto Standby, Bluetooth Standby)
- Lighting (Illumination) setting (switching the Lighting Mode)
- Switching of the audio source for playback among the device connected via a BLUETOOTH connection, the device connected to the AUDIO IN jack, and the device connected to the PLAY/CHARGE OUTPUT port (USB)
- Switching Bluetooth Connection Quality (Priority on Sound Quality/Priority on Stable Connection)
- Multipoint connection (concurrent connection with 2 BLUETOOTH devices) management
- Viewing the update or version of the speaker’s software
- Operations including establishment and disconnection of connections with BLUETOOTH devices
- Setting up the Sound Field Optimization

etc.

Note

- What you can control with “Sony | Music Center” varies depending on the connected device. The specifications and design of the app may change without notice.
- Be sure to use the latest version of “Sony | Music Center.” If you cannot connect the speaker and a BLUETOOTH device via a BLUETOOTH connection, or if there is a problem such as no sound being emitted, uninstall “Sony | Music Center” and try to connect via the BLUETOOTH connection again. For details about “Sony | Music Center,” refer to Google Play (Play Store) or the App Store.
- Be aware that “Sony | Music Center” and “Music Center for PC” are different apps.

Related Topic

- [Installing “Sony | Music Center”](#)

- Charging the speaker
- Turning on/off the speaker's light (Lighting function)
- Connecting the speaker concurrently with 2 BLUETOOTH devices (multipoint connection)
- Selecting the quality for music playback via a BLUETOOTH connection (Codec)
- Listening to music wirelessly with 2 speakers (Stereo Pair function)
- Enjoying wireless playback using multiple speakers (Party Connect function)
- Updating the pre-installed software

5-056-532-11(1) Copyright 2024 Sony Corporation

Wireless Speaker
ULT FIELD 7

Installing “Sony | Music Center”

Install “Sony | Music Center” on your smartphone, etc. from Google Play (Play Store) or the App Store. For Apple iOS devices, “Sony | Music Center” can be installed on the devices with iOS 11.0 or later. Installation is not available on the devices with iOS 10.x or earlier.

- 1 Download “Sony | Music Center” from Google Play (Play Store) or the App Store and install it.



Sony Music Center



- 2 When the installation is complete, start “Sony | Music Center.”

Note

- Be aware that “Sony | Music Center” and “Music Center for PC” are different apps.
- Be sure to use the latest version of “Sony | Music Center.” If you cannot connect the speaker and a BLUETOOTH device via a BLUETOOTH connection, or if there is a problem such as no sound being emitted, uninstall “Sony | Music Center” and try to connect via the BLUETOOTH connection again. For details about “Sony | Music Center,” refer to Google Play (Play Store) or the App Store.

Related Topic

- [What you can do with “Sony | Music Center”](#)

Wireless Speaker
ULT FIELD 7

What you can do with “Fiestable”

“Fiestable” is an app for operating Sony audio devices compatible with “Fiestable” from smartphones, etc.

Available controls

- DJ Control
You can include sound effects (Isolator, etc.) in the music being played.

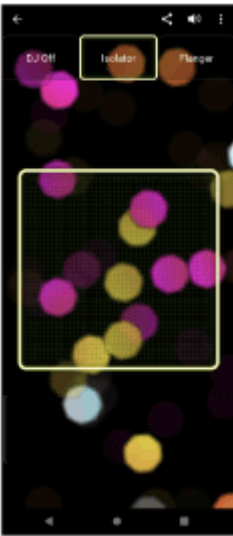

- Illumination
You can set the lighting function.



- Motion Control
You can perform sound operations by shaking the smartphone.



- Others

You can enjoy various features including Karaoke, Voice Control, Party Light, and Party Playlist.

Hint

- What you can control with “Fiestable” varies depending on the connected device. The specification and design of the app may change without notice.

Wireless Speaker
ULT FIELD 7

Installing “Fiestable”

Install “Fiestable” on your smartphone, etc. from Google Play (Play Store) or the App Store. For Apple iOS devices, “Fiestable” can be installed on the devices with iOS 11.0 or later. Installation is not available on the devices with iOS 10.x or earlier.

- 1 Download “Fiestable” from Google Play (Play Store) or the App Store and install it.



Fiestable 

- 2 When the installation is complete, start “Fiestable” from the “Sony | Music Center” screen.



Note

- Be sure to use the latest version of “Fiestable.”

Related Topic

- [What you can do with “Fiestable”](#)

About the indicators

CHARGE indicator (orange)





Unlit	Battery charging is complete.
Lit	Battery charging is in progress.
Slow flashing	The built-in battery is running at 20% or less and needs to be charged.
Flashes 3 times and turns off	In the event that the CHARGE indicator flashes 3 times and then the speaker turns off after the speaker is turned on, the built-in battery is empty and needs to be charged.

Note

- While the speaker is turned on, it charges the built-in battery as long as the speaker is connected to an AC outlet by the supplied AC power cord (mains lead). Depending on the usage of the speaker, however, it may take a long time before charging completes. It is recommended that you turn off the speaker before battery charging.
- If the ambient temperature is extremely low or high, the speaker will stop charging the built-in battery for safety reasons. It may also stop charging if charging continues for a long period of time. If such an event occurs, bring the temperature up or down to an operating temperature between 5 °C and 35 °C (41 °F and 95 °F), disconnect and reconnect the AC power cord (mains lead), and then let the speaker charge the built-in battery once again.

⏻ (power) indicator



Unlit	The speaker is turned off.
Lit (green)	The speaker is turned on.
Lit (orange)	The speaker is turned off. The BLUETOOTH standby function is activated.

Flashes (green or orange)	<ul style="list-style-type: none"> ● Each time you press –/+ (volume) buttons, the indicator flashes once in green. ● When you operate –/+ (volume) buttons and the volume is set at the lowest (0) or highest (50) level, the indicator flashes 3 times in green. ● When ► (play) button and – (volume) button are pressed and held simultaneously for about 5 seconds and the Auto Standby function is turned off, the indicator flashes 3 times in orange. ● When ► (play) button and – (volume) button are pressed and held simultaneously for about 5 seconds and the Auto Standby function is turned on, the indicator flashes twice in orange. ● When ► (play) button and  (BLUETOOTH) button are pressed and held simultaneously for about 2 seconds and the “Priority on Stable Connection” preference is selected for the BLUETOOTH connection quality, the indicator flashes 3 times in green. ● When ► (play) button and  (BLUETOOTH) button are pressed and held simultaneously for about 2 seconds and the “Priority on Sound Quality” preference is selected for the BLUETOOTH connection quality, the indicator flashes twice in green. ● When the ULT button and the – (volume) button are pressed and held simultaneously for about 2 seconds and the ULT POWER SOUND notification sound is turned off, the indicator flashes 3 times in green. ● When the ULT button and the – (volume) button are pressed and held simultaneously for about 2 seconds and the ULT POWER SOUND notification sound is turned on, the indicator flashes twice in green. ● As the software update progresses, the activity of the green  (power) indicator changes (from 5 flashes to 4 flashes, a single flash, and then unlit*). ● When the speaker is turned on for the first time after the software update, the green  (power) and blue  (BLUETOOTH) indicators flash simultaneously 3 times.
Double flashing (orange)	An abnormality in the interior temperature or in the built-in rechargeable battery is detected. Turn off the speaker, disconnect the AC power cord (mains lead), wait for a while, and then restart the speaker. For details, see Notes on charging .
Triple flashing (orange)	An abnormality, such as an invalid button operation or disconnection of a BLUETOOTH connection, is detected (an electric circuit error). Follow the steps described in Restarting the speaker to restart the speaker.
Quadruple flashing (orange)	<ul style="list-style-type: none"> ● The software update was canceled by “Sony Music Center.” ● The software update failed.

* Depending on the situation, you may not be able to see all flashing patterns.

(BLUETOOTH) indicator (blue)

Unlit	The BLUETOOTH function is not activated on the speaker.
Lit	The speaker is connected to a BLUETOOTH device.

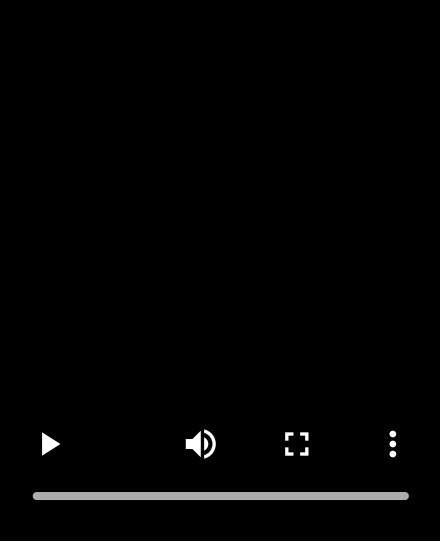
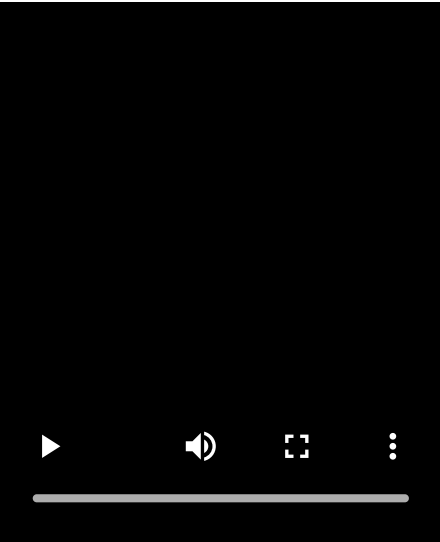
Flashes	<ul style="list-style-type: none"> ● The software update was canceled by “Sony Music Center.” ● The software update failed. ● When the speaker is turned on for the first time after the software update, the blue  (BLUETOOTH) and green  (power) indicators flash simultaneously 3 times.
Double flashing	<p>The speaker is in pairing mode.</p> 
Slow flashing	<p>The speaker is waiting for a BLUETOOTH device to connect to.</p> 

Multi color indicator (ULT button)

Lit	The sound mode is set to ULT1 or ULT2.
Unlit	The sound mode is set to other than ULT1 or ULT2.

GUITAR indicator (white)

Lit	The speaker is in guitar mode.
Unlit	The speaker is not in guitar mode.

ECHO indicator (white)

Lit	The microphone echo level is set to 1, 2, or 3.
Unlit	<ul style="list-style-type: none">• The microphone echo effect is not activated or no microphone is connected to the speaker.• While the microphone echo level is set to 3, pressing the ECHO button behind the cap on the rear side of the speaker deactivates the microphone echo effect and turns off the indicator.
Flashing	While the microphone echo level is set to 1 or 2, pressing the ECHO button behind the cap on the rear side of the speaker makes the indicator flash once.

KEY CONTROL **b** (flat) indicator (white)

Lit	The key control level for the b (flat) notes is set to a level between -1 to -6.
Unlit	No key control level is set for the b (flat) notes or no microphone is connected to the speaker.
Flashing	<ul style="list-style-type: none">• Pressing the KEY CONTROL b (flat) button behind the cap on the rear side of the speaker makes the indicator flash once.• While the key control level for the b (flat) notes is set to -6, pressing the KEY CONTROL b (flat) button behind the cap on the rear side of the speaker makes the indicator flash 3 times.

KEY CONTROL **#** (sharp) indicator (white)

Lit	The key control level for the # (sharp) notes is set to a level between +1 to +6.
Unlit	No key control level is set for the # (sharp) notes or no microphone is connected to the speaker.
Flashing	<ul style="list-style-type: none">• Pressing the KEY CONTROL # (sharp) button behind the cap on the rear side of the speaker makes the indicator flash once.• While the key control level for the # (sharp) notes is set to +6, pressing the KEY CONTROL # (sharp) button behind the cap on the rear side of the speaker makes the indicator flash 3 times.

Related Topic

- [Parts and controls](#)
- [What you can do with “Sony | Music Center”](#)

Wireless Speaker
ULT FIELD 7

Updating the pre-installed software

When a new version of the software is released, you can update your speaker's pre-installed software by using the following methods.

By updating the software, new features will be added enabling you to experience more convenient and stable use.

1 Connect the speaker to an AC outlet with the supplied AC power cord (mains lead).

Software updates cannot be performed when using with the built-in battery.

2 Turn on the speaker.

You hear the notification sound from the speaker, and the  (power) indicator lights up in green.

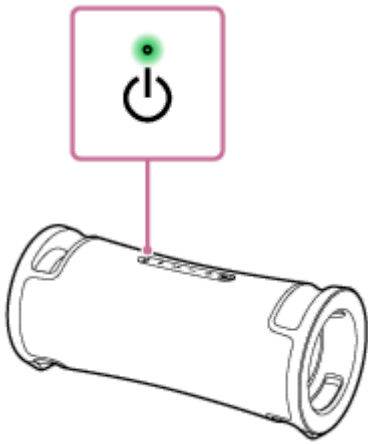

3 Tap [Music Center] on your smartphone, etc. to start up the application.



Music Center



4 Tap [ULT FIELD 7].

When a new version of the software is released, an update notice is displayed on the "Sony | Music Center" screen.

5 Follow the instructions on the screen to update.

As the software update progresses, the activity of the green  (power) indicator changes (from 5 flashes to 4 flashes, a single flash, and then unlit).

Depending on the situation, you may not be able to see all flashing patterns.

When the speaker is turned on for the first time after the software update, the green  (power) and blue  (BLUETOOTH) indicators flash simultaneously 3 times to inform you that the update is complete.

6 Confirm the version of the speaker's software.

On "Sony | Music Center," tap [ULT FIELD 7] - [Settings] - [System].

“XXXXXXX” displayed under “ULT FIELD 7” indicates the software version.

Hint

- When the software update fails, turn off the speaker and then turn it back on. The speaker will recover from the error state.

Note

- When an attempt to update the software fails, charge the rechargeable built-in battery until it is charged 40% or more. You can view the remaining power of the rechargeable built-in battery on “Sony | Music Center.”

Related Topic

- [Charging the speaker](#)
- [About the indicators](#)

5-056-532-11(1) Copyright 2024 Sony Corporation

Wireless Speaker
ULT FIELD 7

Precautions

On safety

- Refer to the Reference Guide supplied with the speaker.
- Important information such as the model name is located on the inner surface of the cap on the rear side of the speaker.

On the power cord

- The supplied AC power cord (mains lead) is designed exclusively for this speaker. It should not be used in combination with any other devices.
- Completely disconnect the AC power cord (mains lead) from the AC outlet (mains) if it is not going to be used for an extended period of time. When unplugging the AC power cord (mains lead), always grip the plug. Never pull the cord itself.
- AC power cord (mains lead) must be changed only at a qualified service shop.

On placement

- To eliminate the risk of malfunctions, avoid the following locations when placing or leaving this speaker.
 - A place subject to high temperatures, such as under direct sunlight or lighting equipment, near a heat source, or in a sauna
 - Inside a vehicle with the windows closed (especially in summertime)
 - A place exposed to hot air, such as from a hair dryer
 - A place subject to excessive dust
 - A place subject to strong vibration
- Place this speaker on a flat, level surface. When placed on a sloped surface, the speaker may fall over or fall off the surface due to its own vibration, resulting in injuries, malfunctions, or performance degradation.
- Depending on the conditions where this speaker is placed, it may fall over or fall off the surface. Do not leave any valuables near the speaker.
- This speaker is not anti-magnetic. Keep objects susceptible to magnetism (recorded tapes, watches, cash cards and credit cards with magnetic coding, etc.) away from the speaker. When you carry around the speaker, keep this in mind as well.

Other notes

- Do not use or leave the speaker in an extremely cold or hot environment (temperature outside the range of 5 °C - 35 °C (41 °F - 95 °F)). If the speaker is used or left in outside the above range, the speaker may automatically stop to protect internal circuitry.
- If you use this speaker for a long time, the temperature of this speaker may rise, but it is not a malfunction.

- At high temperature, the charging may stop or the volume may reduce to protect the battery.
- Even if you do not intend to use the speaker for a long time, charge the battery to its full capacity once every 6 months to maintain its performance.
- If your skin remains in contact with the handle for a long time while the light is turned on, there is a risk of low-temperature burns. To carry a speaker while it is powered on, turn the light (lighting function) off.
- If you have any questions or problems concerning this speaker that are not covered in this manual, please consult your nearest Sony dealer.

5-056-532-11(1) Copyright 2024 Sony Corporation

Wireless Speaker
ULT FIELD 7

Notes on charging

Life span of the built-in lithium ion battery

- Even if you do not intend to use the speaker for a long time, charge the built-in battery sufficiently once every 6 months to maintain its performance.
- If the speaker is not used for a long time, it may take longer to charge the built-in battery.
- The rechargeable built-in battery has a life span. As time passes and the number of times that the built-in battery is used increases, the capacity of the rechargeable built-in battery slowly decreases. When the amount of time that the built-in battery can be used seems significantly shorter, despite having been fully charged, contact your nearest Sony dealer.
- When the amount of time that the built-in battery can be used seems significantly shorter, it could mean that the rechargeable built-in battery has expired.
- The life span of the rechargeable built-in battery differs depending on the usage, environment, and storage method.

Caution

When the speaker detects an abnormality in the interior temperature or in the built-in rechargeable battery, the  (power) indicator starts double flashing in orange.

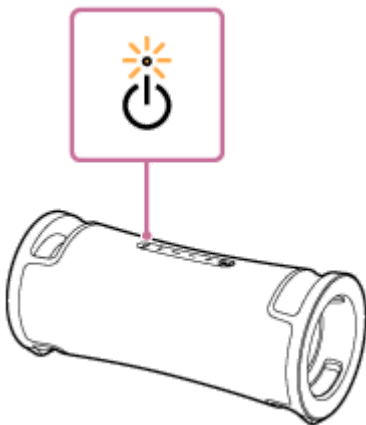

If an abnormality is detected, disconnect the AC power cord (mains lead), wait for a while, and then restart the speaker (by pressing and holding the  (power) button for about 10 seconds). If the problem persists, contact your nearest Sony dealer.

Note

- Charging time varies depending on built-in battery usage conditions.
- Charge the speaker in an ambient temperature between 5 °C and 35 °C (41 °F and 95 °F). Be aware that the room temperature may fall to 5 °C (41 °F) or lower depending on the season, for example, especially in wintertime.
- The speaker becomes warm during charging. This is not a malfunction.
- Avoid exposure to rapid temperature change, direct sunlight, mist, sand, dust, or mechanical shock. Also, never leave the speaker in a car parked in the sun.

- As long as the speaker is connected to an AC outlet by the supplied AC power cord (mains lead), the speaker's built-in battery is capable of charging itself even while the speaker is turned on. However, it may take a long time before charging completes depending on the usage of the speaker. It is recommended that you turn off the speaker before battery charging.
- In an extremely cold or hot environment, charging stops for safety. If charging takes a long time, it also makes charging of the speaker stop. To resolve these issues, disconnect the AC power cord (mains lead) from the speaker and connect it again within an operating temperature between 5 °C and 35 °C (41 °F and 95 °F).
- At high temperature, the charging may stop or the volume may reduce to protect the battery.

Related Topic

- [Charging the speaker](#)
- [Restarting the speaker](#)

5-056-532-11(1) Copyright 2024 Sony Corporation

Notes on waterproof and dustproof features

Waterproof and dustproof performance of the speaker

The speaker, with the cap closed securely, has a waterproof specification of IPX7^{*1} as specified in “Degree of protection against water immersion” of the IEC60529 “Ingress Protection Rating (IP Code)”^{*3}, and a dustproof specification of IP6X^{*2} as specified in “Degrees of protection against solid foreign objects”^{*3}.

Liquids that the waterproof performance specifications apply to

Applicable	fresh water, tap water, pool water
Not applicable	liquids other than the above (soapy water, water with detergent or bath agents, shampoo, hot spring water, salt water, etc.)

*1 IPX7 equivalency: The speaker has been tested to and maintains its operability when gently submersed in water to a depth of 1 m (3.2 ft) and left for 30 minutes.

*2 IP6X equivalency: The speaker has been tested to and continues to block dust after stirring for 8 hours in a testing device which contains dust particles that are up to 75 µm in diameter.

*3 The supplied accessories and the connectors of this speaker (AC IN, USB, AUDIO IN, MIC) are neither waterproof nor dustproof. To reduce the risk of fires or electric shocks, do not expose the speaker to water or droplets while using any connectors (AC IN, USB, AUDIO IN, MIC).

The waterproof performance of the speaker is based on our measurements under the conditions herein described. Note that malfunctions as a result of water immersion or dust intrusion caused by misuse by the customer are not covered by the warranty.

To maintain waterproof and dustproof performance

Carefully note the precautions below to ensure proper use of the speaker.

- This speaker does not have a design that is resistant to water pressure. Use of the speaker in a location where high water pressure is applied, such as in the shower, may cause a malfunction.
- Do not pour high-temperature water or blow hot air from a hair dryer or any other appliance on the speaker directly. Also never use the speaker in a place subject to high temperatures, such as in a sauna or near a heat source.
- Handle the cap (①) with care. The cap plays a very important role in maintenance of the waterproof and dustproof performance. When using the speaker, make sure that the cap is closed completely. When closing the cap, be careful not to allow foreign objects inside. If the cap is not closed completely the waterproof and dustproof performance may deteriorate and may cause a malfunction of the speaker as a result of water or dust particles entering the speaker.

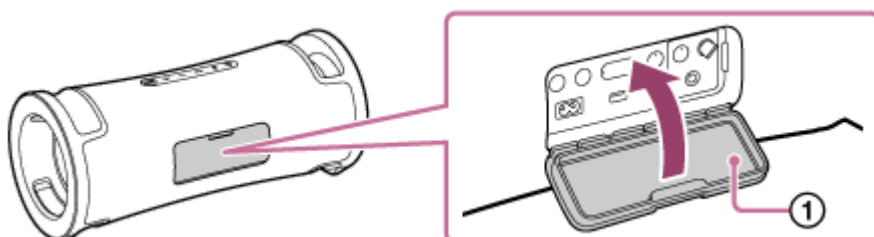

Wireless Speaker
ULT FIELD 7

How to care for the speaker

Although the fabric part of the speaker has water repellent treatment applied, you can use the speaker more comfortably and for a longer period of time by following the maintenance procedure below.

- If the surface of the speaker gets dirty in the following cases, wash the speaker with fresh water (tap water, etc.) promptly to remove the dirt. Leaving dirt on its surface may cause the fabric part or the passive radiator section (①) to discolor or deteriorate, or the speaker to malfunction.

Ex.

- When the speaker has sand, salt (chlorine), or other residue on it after having been used in a mountain area, by a swimming pool, etc.
- When the speaker is stained with foreign substances (sunscreen, suntan oil, etc.)

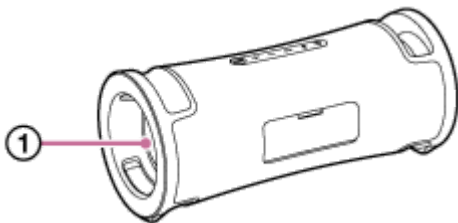

- Wipe off the moisture on its surface, and put the speaker on a dry soft cloth to drain the collected water inside the speaker. Then, dry the speaker in an airy place until no moisture remains.
- The sound quality may change when water enters the speaker or passive radiator section of the speaker. It is not malfunction. Wipe off the moisture on its surface, and put the speaker on a dry soft cloth to drain the collected water inside the speaker. Then, dry the speaker in an airy place until no moisture remains.

Note

- If the surface of the speaker gets dirty, do not use detergent, thinner, benzine, alcohol, etc. to clean the speaker because it will affect the water repellent function of the fabric part of the speaker.
- Especially in cold regions, be sure to wipe off the moisture after using the speaker. Leaving moisture on its surface may cause the speaker to freeze and malfunction.
- If sand grains, etc. enter the fabric or other part of the speaker, remove them carefully. Never use a vacuum cleaner, etc. on the speaker. It may cause damage of the speaker section or other part of the speaker.

Wireless Speaker
ULT FIELD 7

About the BLUETOOTH wireless technology

The BLUETOOTH wireless technology is a short-range wireless technology that enables communication between digital devices, such as smartphones and computers.

Supported version and profiles of the BLUETOOTH standard

A profile is a set of functions standardized for every characteristic of BLUETOOTH devices. The speaker supports the following version and profiles of the BLUETOOTH standard.

Supported BLUETOOTH version: BLUETOOTH standard, version 5.2

Supported BLUETOOTH profiles:

- A2DP (Advanced Audio Distribution Profile): Enables transmission and reception of high-quality music contents.
- AVRCP (Audio Video Remote Control Profile): Enables volume adjustment and operations to play/pause music and skip to the beginning of the next/current track.

Maximum communication range

Use the BLUETOOTH wireless technology between the speaker and a device that are located within about 30 m (98.4 ft) from each other.

Maximum communication range may shorten under the following conditions.

- There is an obstacle such as a person, metal, or wall between the speaker and BLUETOOTH device.
- A wireless LAN device is in use near the speaker.
- A microwave oven is in use near the speaker.
- A device that generates electromagnetic radiation is in use near the speaker.

Frequency band

2.4 GHz band (2.400 0 GHz - 2.483 5 GHz)

Corresponding content protection

SCMS-T

Transmission range (A2DP)

20 Hz - 20 000 Hz (Sampling frequency 44.1 kHz)

Interference from other devices

Because BLUETOOTH devices and wireless LAN (IEEE802.11ax/b/g/n) use the same frequency (2.4 GHz), microwave interference may occur and result in communication speed deterioration, noise, or invalid connection if the speaker is used near a wireless LAN device.

Interference to other devices

Microwaves emitted from a BLUETOOTH device may affect the operation of electronic medical devices. Turn off the speaker and other BLUETOOTH devices in the following locations, as it may cause an accident.

- Where inflammable gas is present, in a hospital, train, airplane, or a gas station
- Near automatic doors or a fire alarm

Note

- Depending on the network environment, there may be an interruption at the high bitrate transmission.
- To be able to use the BLUETOOTH function, the BLUETOOTH device to be connected requires the same profile as the speaker's. Note also that even if the same profile exists, devices may vary in function depending on their specifications.
- Due to the characteristic of BLUETOOTH wireless technology, the sound played on the speaker is slightly delayed from the sound played on the BLUETOOTH device while listening to music.
- The speaker supports security capabilities that comply with the BLUETOOTH standard to provide a secure connection when the BLUETOOTH wireless technology is used, but security may not be enough depending on the setting. Be careful when communicating using BLUETOOTH wireless technology.
- We do not take any responsibility for the leakage of information during BLUETOOTH communication.
- A device featuring the BLUETOOTH function is required to conform to the BLUETOOTH standard specified by Bluetooth SIG, Inc. and be authenticated. Even if the connected device conforms to the above mentioned BLUETOOTH standard, some devices may not be connected or work correctly, depending on the features or specifications of the device.
- Noise or sound interruption may occur depending on the BLUETOOTH device connected with the speaker, the communication environment or the usage environment.
- A device with a built-in radio or tuner cannot be connected to the speaker via a BLUETOOTH connection since noise may occur in broadcasts.
- Locate the speaker farther away from a TV, radio or tuner, etc. since noise may occur in broadcasts.

Wireless Speaker
ULT FIELD 7

Licenses

- This product contains software that Sony uses under a licensing agreement with the owner of its copyright. We are obligated to announce the contents of the agreement to customers under requirement by the owner of copyright for the software. Please access the following URL and read the contents of the license.
<https://rd1.sony.net/help/speaker/sl/24/>
- Use of the Made for Apple badge means that an accessory has been designed to connect specifically to the Apple product(s) identified in the badge, and has been certified by the developer to meet Apple performance standards. Apple is not responsible for the operation of this device or its compliance with safety and regulatory standards. Please note that the use of this accessory with an Apple product may affect wireless performance.
- Services offered by third parties may be changed, suspended, or terminated without prior notice. Sony does not bear any responsibility in these sorts of situations.

Wireless Speaker
ULT FIELD 7

Trademarks

- Google, Android and Google Play are trademarks of Google LLC.
- Apple, the Apple logo, iPhone, iPod, iPod touch, Mac, and macOS are trademarks of Apple Inc., registered in the U.S. and other countries.
- App Store is a service mark of Apple Inc., registered in the U.S. and other countries.
- IOS is a trademark or registered trademark of Cisco in the U.S. and other countries and is used under license.
- Microsoft, Windows and Windows Media are either trademarks or registered trademarks of Microsoft Corporation in the United States and/or other countries.
- The BLUETOOTH® word mark and logos are registered trademarks owned by Bluetooth SIG, Inc. and any use of such marks by Sony Group Corporation and its subsidiaries is under license.
- LDAC and LDAC logo are trademarks of Sony Group Corporation or its affiliates.

All other trademarks and registered trademarks are trademarks or registered trademarks of their respective holders. In this manual, ™ and ® marks are not specified.

Wireless Speaker
ULT FIELD 7

What can I do to solve a problem?

If the speaker does not function as expected, try the following steps to resolve the issue.

- Find the symptoms of the issue in this Help Guide and try any corrective actions listed.
- Charge the speaker.
You may be able to resolve some issues by charging the built-in battery.
- Restart the speaker.
- Initialize the speaker.
This operation restores the settings such as volume, etc. to the default settings, and deletes all pairing information.
- Look up information on the issue on the customer support website.
- Access the following support home pages to get support information about your speaker:
 - For customers in Americas:
<https://www.sony.com/am/support>
 - For customers in Europe:
<https://www.sony.eu/support>
 - For customers in China:
<https://service.sony.com.cn>
 - For customers in other countries/regions:
<https://www.sony-asia.com/support>

If the operations above do not work, consult your nearest Sony dealer.

Related Topic

- [Restarting the speaker](#)
- [Initializing the speaker](#)

Wireless Speaker
ULT FIELD 7

Unable to charge the speaker

- Make sure that the AC power cord (mains lead) is connected securely to the speaker. Then, make sure that the AC power cord (mains lead) is connected securely to an AC outlet.
 - Charge the speaker in an ambient temperature between 5 °C and 35 °C (41 °F and 95 °F). Be aware that the room temperature may fall to 5 °C (41 °F) or lower depending on the season, for example, especially in wintertime.
-

Related Topic

- [Charging the speaker](#)
- [About the indicators](#)
- [Notes on charging](#)

Wireless Speaker
ULT FIELD 7

Unable to turn on the speaker or the speaker suddenly turns off

- The rechargeable built-in battery may be empty or running low. Connect the speaker to an AC outlet with the supplied AC power cord (mains lead) for battery charging.
 - The Auto Standby function may have been activated. Deactivate the Auto Standby function.
 - Bringing the microphone close to the speaker may cause acoustic feedback. When this happens, depending on the sound volume of the speaker, the speaker may turn off due to the product protection feature. In that case, disconnect the AC power cord (mains lead), wait for a while, and then turn on the speaker again.
-

Related Topic

- [Charging the speaker](#)
- [Auto Standby \(power saving\) function](#)
- [There is acoustic feedback](#)

No sound/Sound from only one speaker/Low sound level/Distorted sound/Humming or noise in the speaker output

- Check that both the speaker and the connected device are turned on.
- Turn up the volume of the speaker and the connected device.
- Depending on the connected BLUETOOTH device, volume adjustment on the BLUETOOTH device may not change the volume level of the speaker (i.e. the ⏻ (power) indicator does not flash).
When the volume of the speaker sounds low, adjust the volume level of the BLUETOOTH device to an appropriate one, and then adjust the volume level of the speaker with $-/+$ (volume) buttons.
- Check that the connected device is playing.
- Make sure the audio cable and USB device are disconnected from both of the AUDIO IN jack and PLAY/CHARGE OUTPUT port (USB) during playback in BLUETOOTH mode.
- Make sure the audio cable is firmly connected to the AUDIO IN jack during playback in AUDIO IN mode.
- If you are connecting a computer to the speaker, make sure the audio output setting of the computer is set for a BLUETOOTH device.
- Check that the speaker has established a BLUETOOTH connection with the BLUETOOTH device.
- Pair the speaker and the BLUETOOTH device again.
- Before connecting multiple speakers via BLUETOOTH connections for the Stereo Pair function or the Party Connect function, update the pre-installed software to the latest version on each and every speaker.
- If the device that is connected to the AUDIO IN jack is monaural, sound may only be output from the left speaker component (left channel).
- If the connected device has an equalizer function, set it to off.
- Keep the speaker away from a microwave oven, wireless LAN, etc.
- Bring the BLUETOOTH device closer to the speaker. If there is any obstacle between the speaker and the BLUETOOTH device, move it out of the way.
- If the CHARGE indicator flashes slowly, turn off the speaker and charge the built-in battery sufficiently.
- A device with a built-in radio or tuner cannot be connected to the speaker via a BLUETOOTH connection since noise may occur in broadcasts.
- Locate the speaker farther away from a TV, radio or tuner, etc. since noise may occur in broadcasts.
- When using the Stereo Pair function or Party Connect function, if any other BLUETOOTH device(s) such as a BLUETOOTH mouse or BLUETOOTH keyboard is connected to the BLUETOOTH device, terminate the connection between them.
- There are some BLUETOOTH devices that can have the BLUETOOTH connection quality changed. If your device is compatible with this function, select "Priority on Stable Connection (SBC)" for the BLUETOOTH connection quality. For details, refer to the operating instructions supplied with the device.

- Select “Priority on Stable Connection (SBC)” for the BLUETOOTH connection quality of the speaker.
- Install the latest version of “Sony | Music Center” on the connected device. If you cannot use the latest version of “Sony | Music Center” or you cannot connect the speaker and a BLUETOOTH device via a BLUETOOTH connection, uninstall “Sony | Music Center” and install it again.
- Depending on the app being used on the connected BLUETOOTH device, you may hear no sound. In such a case, close the app and start it once again. This may help for solving the issue.

Related Topic

- [Charging the speaker](#)
- [Pairing and connecting with BLUETOOTH devices](#)
- [Listening to music of a device via a BLUETOOTH connection](#)
- [Selecting the quality for music playback via a BLUETOOTH connection \(Codec\)](#)
- [About the indicators](#)

Wireless Speaker
ULT FIELD 7

Sound becomes low while in use

- The sound may become low in the following cases. This is not a malfunction.
 - The rechargeable built-in battery is running out of power and the CHARGE indicator flashes slowly while the speaker is running on power from the rechargeable built-in battery.
 - The ambient temperature of the speaker is high.
 - If the sound becomes low while in use, follow the procedure below.
 1. Turn off the speaker.
 2. Charge the built-in battery sufficiently.
-

Related Topic

- [Charging the speaker](#)

Wireless Speaker
ULT FIELD 7

The USB device is not detected; playback from an audio source fails; no sound comes out of the speaker; playback does not start with the first track

- Turn off the speaker, disconnect and reconnect the USB device, and then turn the speaker back on.
- The connected USB device is not compatible with the speaker. Check on the information about the compatible devices.
- Check the USB device for the file format. The speaker does not support USB devices formatted with any file system other than FAT16 or FAT32.*
 - * While the speaker supports the FAT16 and FAT32 file systems, some USB devices may not support these FAT file systems. For details, refer to the operating instructions provided with your USB device or contact its manufacturer.
- Use “Sony | Music Center” to resume normal playback mode.
- When the connected USB device has partitioned storage space, the speaker is only capable of playing the audio files stored in the first partition.
- The speaker is not capable of playing any encrypted or password-protected files.
- The speaker is not capable of playing any files protected with the DRM (Digital Rights Management) technology.
- When the connected USB device does not work correctly, refer to the operating instructions provided with your USB device.

Related Topic

- [Connecting with a USB device](#)
- [Listening to music of a USB device](#)

The sound from the speaker contains noise, skips, or is distorted

- The connected USB device is not compatible with the speaker. Check on the information about the compatible devices.
 - Turn off the speaker, disconnect and reconnect the USB device, and then turn the speaker back on.
 - Make sure that the audio file itself does not contain noise or distortion. Noise may be generated while an audio file is encoded. If this is the case, delete the audio file and encode the original audio file all over again. If the sound from the speaker contains noise or is distorted always at the same point in playback, this suggests that the file itself has a problem.
 - The bit rate setting for creating or encoding audio files is low. Increase the bit rate and encode the original audio file on the USB device.
-
-

Related Topic

- [Connecting with a USB device](#)





Wireless Speaker
ULT FIELD 7

It takes a long time before playback starts

In the event of the following, it may take some time for the speaker to load audio data.

- The USB device has many folders or files.
- The USB device has a highly complicated structure.
- The USB device has a memory capacity that is too large for the speaker to handle.
- The internal memory of the USB device is fragmented.

Unable to pair the speaker with a BLUETOOTH device

- Place the speaker and the BLUETOOTH device within 1 m (3.2 ft) of each other.
 - To use the Stereo Pair function or Party Connect function, pair with the speaker in which the  (BLUETOOTH) indicator flashes in blue.
 - If the  (BLUETOOTH) indicator is not double flashing in blue, press  (BLUETOOTH) button for about 2 seconds. You hear voice guidance (Pairing) from the speaker and the  (BLUETOOTH) indicator starts double flashing (pairing mode).
 - Once the speaker is initialized, an iPhone may not be able to connect to the speaker. In this case, delete pairing information on the iPhone, then pair them again.
 - Check that the BLUETOOTH device is turned on and the BLUETOOTH function is activated on the device.
 - If the speaker is not displayed on the BLUETOOTH device, turn off the device, and then turn on the device again. It may improve symptoms.
 - Depending on the specifications of the TV, no BLUETOOTH connection may be established between the speaker and the TV even though the TV has the BLUETOOTH function.
-

Related Topic

- [Pairing and connecting with BLUETOOTH devices](#)
- [About the indicators](#)
- [Initializing the speaker](#)

Wireless Speaker
ULT FIELD 7

Speaker output is interrupted

While the “Priority on Sound Quality” preference is selected for the BLUETOOTH connection quality, signal reception on the speaker may fluctuate depending on the combination of the setup on your BLUETOOTH device and the ambient conditions. In such a case, the following may help for solving the issue.

- Move the speaker away from a device such as a microwave oven and a wireless LAN access point.
 - There are some BLUETOOTH devices that can have the BLUETOOTH connection quality changed. If your device is compatible with this function, select “Priority on Stable Connection (SBC)” for the BLUETOOTH connection quality. For details, refer to the operating instructions supplied with the device.
 - Select “Priority on Stable Connection (SBC)” for the BLUETOOTH connection quality of the speaker.
-

Related Topic

- [Selecting the quality for music playback via a BLUETOOTH connection \(Codec\)](#)

Wireless Speaker
ULT FIELD 7

Unable to connect a BLUETOOTH device with the speaker for the Stereo Pair function

- Update the pre-installed software to the latest version on each and every speaker to connect for the function. (For details about the update procedure, see [Updating the pre-installed software.](#))
 - Update “Sony | Music Center” to the latest version before setting up the Stereo Pair function. For details about “Sony | Music Center,” refer to the following URL: <https://www.sony.net/smcqa/>
 - Make sure that the 2 speakers to connect for the function are located within 1 m (3.2 ft) from each other.
 - While music playback is in progress, stop the playback before setting up the Stereo Pair function.
-

Related Topic

- [Listening to music wirelessly with 2 speakers \(Stereo Pair function\)](#)
- [What you can do with “Sony | Music Center”](#)
- [Updating the pre-installed software](#)

Wireless Speaker
ULT FIELD 7

Unable to connect with a speaker for the Party Connect function

- Check if the device is compatible with the Party Connect function. Devices compatible with the Wireless Party Chain function are not applicable for connection.
 - Update the pre-installed software to the latest version on each and every speaker to connect for the function. (For details about the update procedure, see [Updating the pre-installed software.](#))
 - Update “Sony | Music Center” to the latest version before setting up the Party Connect function. For details about “Sony | Music Center,” refer to the following URL:
<https://www.sony.net/smcqa/>
 - Make sure that all of the speakers to connect for the function are located within 1 m (3.2 ft).
 - While music playback is in progress, stop the playback before setting up the Party Connect function.
-

Related Topic

- [Enjoying wireless playback using multiple speakers \(Party Connect function\)](#)
- [What you can do with “Sony | Music Center”](#)
- [Updating the pre-installed software](#)

Wireless Speaker
ULT FIELD 7

Unable to add a speaker for the Party Connect function

- To any group set up with “Sony | Music Center,” use “Sony | Music Center” to add a new speaker. For details about “Sony | Music Center,” refer to the following URL:
<https://www.sony.net/smcqa/>
 - Make sure that all of the speakers to connect for the function are located within 1 m (3.2 ft).
 - While music playback is in progress, stop the playback before setting up the Party Connect function.
-

Related Topic

- [Enjoying wireless playback using multiple speakers \(Party Connect function\)](#)

Wireless Speaker
ULT FIELD 7

Unable to connect the speaker concurrently with 2 devices (multipoint connection)

- When using the Stereo Pair function or the Party Connect function, you cannot use the multipoint connection capability.
 - Depending on the BLUETOOTH device, you may not be able to use the multipoint connection capability.
-

Related Topic

- [Connecting the speaker concurrently with 2 BLUETOOTH devices \(multipoint connection\)](#)

Wireless Speaker
ULT FIELD 7**There is no microphone sound**

- Turn the MIC and GUITAR level knob to adjust the microphone volume.

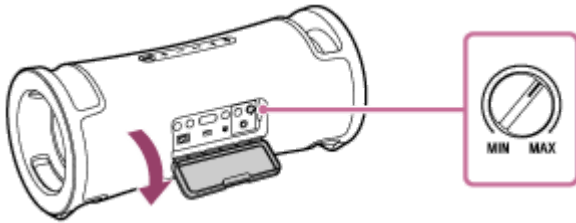

- Make sure that the microphone is turned on.

Wireless Speaker
ULT FIELD 7

There is acoustic feedback

- Reduce the volume.
- Move the microphone away from the speaker or change the direction of the microphone.

Note

- Bringing the microphone close to the speaker may cause acoustic feedback. When this happens, depending on the sound volume of the speaker, the speaker may turn off due to the product protection feature. In that case, disconnect the AC power cord (mains lead), wait for a while, and then turn on the speaker again.

Wireless Speaker
ULT FIELD 7

Restarting the speaker

In the event such as the following, press and hold the  (power) button for about 10 seconds to restart the speaker.

- You cannot operate the speaker after you turn it on.
- You cannot operate the speaker after you troubleshoot pairing issues.

The speaker is turned off during the restart process, and then turned back on upon completion of the process.

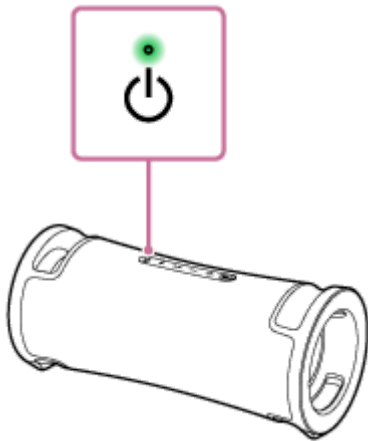

Note

- Restarting the speaker does not delete its pairing information. The pairing information, however, is stored on the speaker when the speaker is turned off. After pairing the speaker with a new device, turn off the speaker and turn it back on, and then restart the speaker.
- Restarting the speaker may change its volume, function, or sound settings.

Wireless Speaker
ULT FIELD 7

Initializing the speaker

If the speaker fails to operate successfully after you restart it, initialize the speaker to resume its default settings. While the speaker is turned on, press and hold **▶||** (play) button and **ULT** button until the speaker turns off (5 seconds or more).

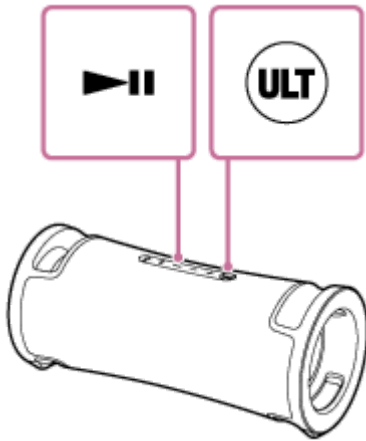

The speaker is initialized. Settings such as volume, etc., are restored to the default settings, and all pairing information is deleted.

Note

- The speaker cannot be initialized while the power is off.

Related Topic

- [Pairing and connecting with BLUETOOTH devices](#)
- [Restarting the speaker](#)

Wireless Speaker
ULT FIELD 7

Specifications

Speaker

Speaker system

2-way, Passive radiator

Speaker unit

Woofer unit: Approx. 114 mm × 114 mm (4.5 in × 4.5 in) (2)

Tweeter unit: Approx. 46 mm (1.9 in) dia. (2)

General

Inputs

- Type A USB port: Supported USB Device (Mass Storage Class)
- AUDIO IN jack (Φ 3.5 mm)
- MIC/GUITAR jack (Φ 6.3 mm)
 - Sensitivity 1 mV, impedance 10 kΩ (when guitar mode is turned off)
 - Sensitivity 200 mV, impedance 500 kΩ (when guitar mode is turned on)

DC OUT

Type A USB port (for charging the battery of a connected device) (DC 5 V/MAX. 1.5 A)

Power

- For customers in North America:
 - AC 120 V, 60 Hz, or using built-in lithium-ion battery
- For customers in other countries/regions:
 - AC 120 V - 240 V, 50/60 Hz, or using built-in lithium-ion battery

Power consumption

Approx. 45 W

Standby power consumption

When BLUETOOTH standby mode is set to on: 2 W or less

When BLUETOOTH standby mode is set to off: 0.5 W or less

Operating temperatures

5 °C - 35 °C (41 °F - 95 °F)

Dimensions (including projecting parts and controls)

Approx. 512 mm × 224 mm × 222 mm (20.2 in × 8.9 in × 8.8 in) (w/h/d)

Mass (including battery)

Approx. 6.3 kg (13 lb 15 oz)

Hint

- For the time required for charging the built-in rechargeable battery and the built-in battery life while audio playback from a BLUETOOTH device is in progress, see [Charging the speaker](#).

Compatible iPhone/iPod models

iPhone 14 Pro Max, iPhone 14 Pro, iPhone 14 Plus, iPhone 14, iPhone SE (3rd generation), iPhone 13 Pro Max, iPhone 13 Pro, iPhone 13, iPhone 13 mini, iPhone 12 Pro Max, iPhone 12 Pro, iPhone 12, iPhone 12 mini, iPhone SE (2nd generation), iPhone 11 Pro Max, iPhone 11 Pro, iPhone 11, iPhone XS Max, iPhone XS, iPhone XR, iPhone X, iPhone 8 Plus, iPhone 8, iPhone 7 Plus, iPhone 7, iPhone SE, iPhone 6s Plus, iPhone 6s, iPod touch (7th generation)
(As of August 2023)

5-056-532-11(1) Copyright 2024 Sony Corporation