

# Assembly | Asamblea | Assemblage

PO#

Customer service | Servicio al cliente | Service clientèle: 800.633.5096

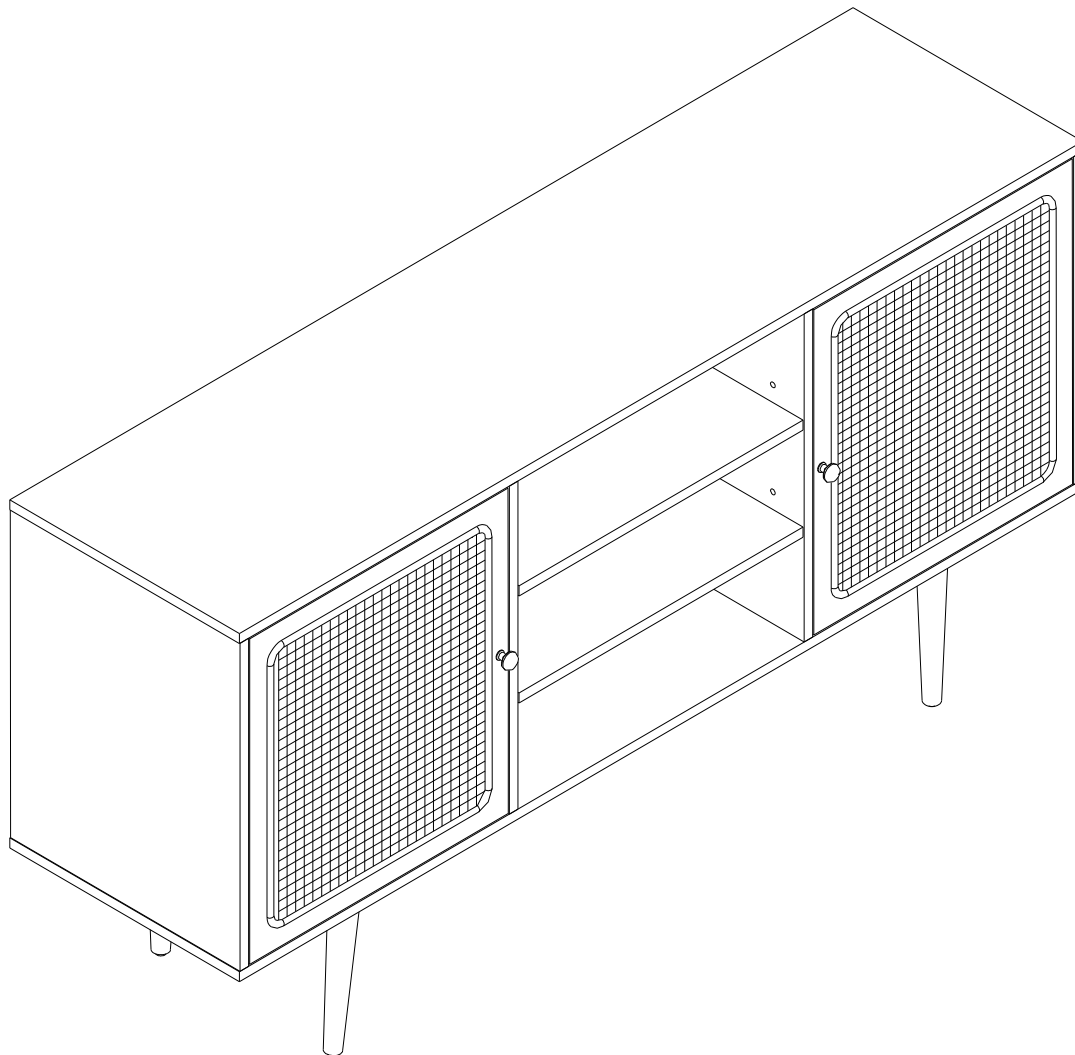

Product number | Número de producto | Numéro de produit

**MS1095013**

Thank you for your purchase! | ¡Gracias por tu compra! | Merci pour votre achat!

# Assembly | Asambllea | Assemblage

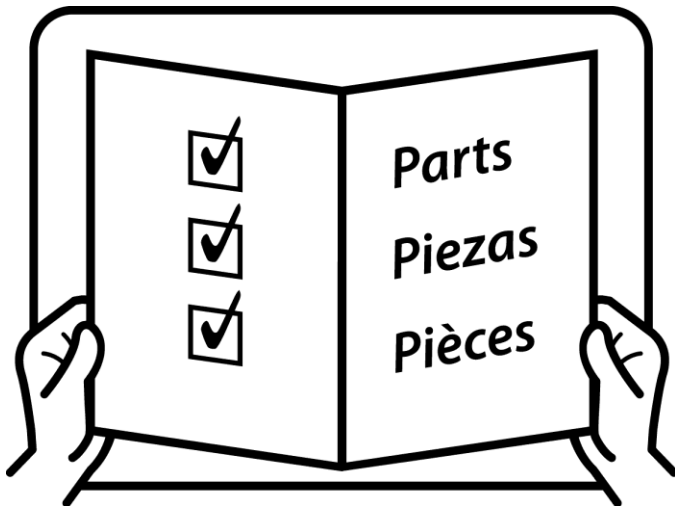
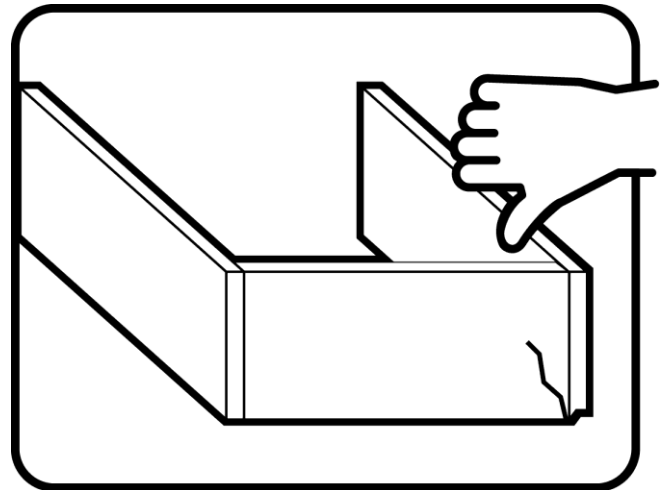
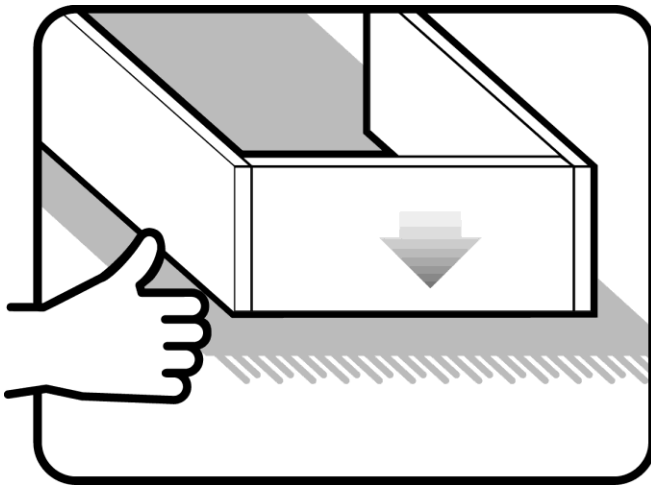
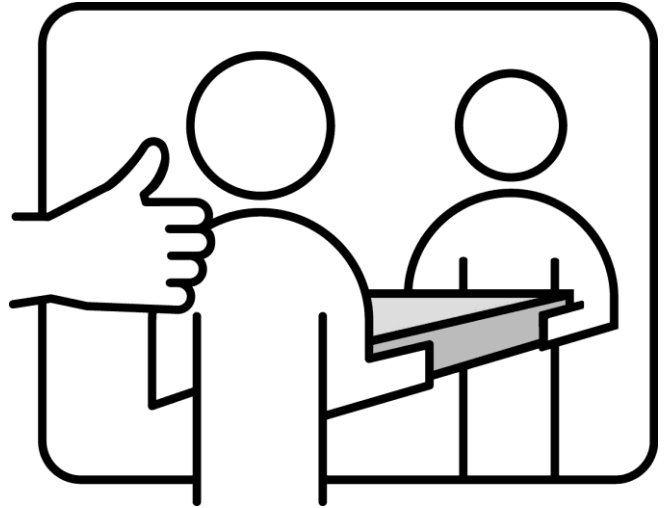
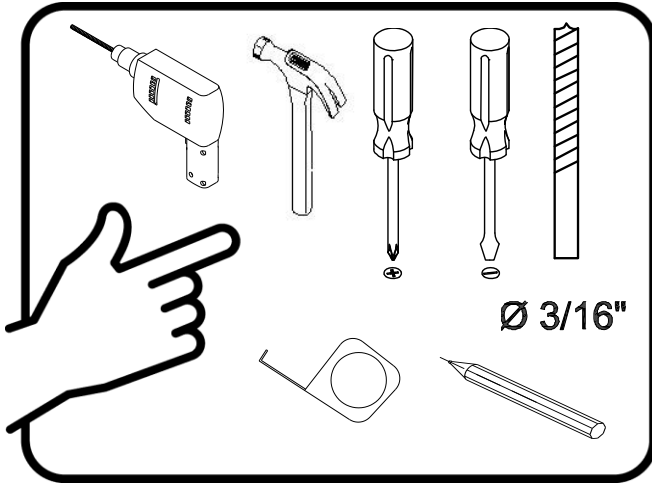

# Assembly | Asamblea | Assemblage

Techniques | Técnicas | Techniques

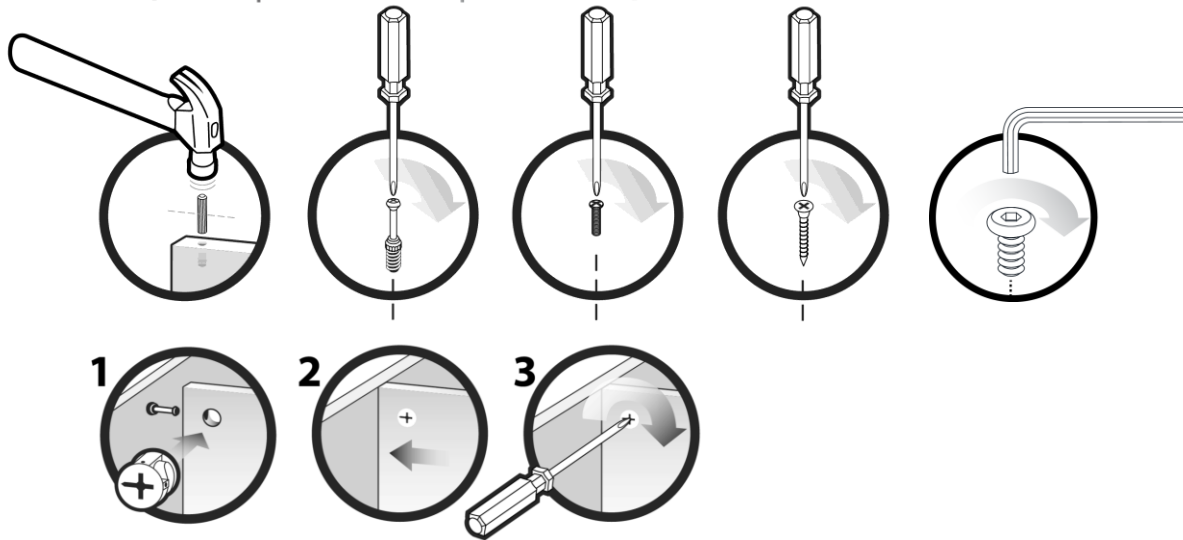

Care | Cuidado | Entretien



Safety | Seguridad | Sécurité







Note! | ¡Nota! | Remarque!

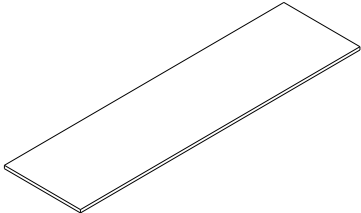
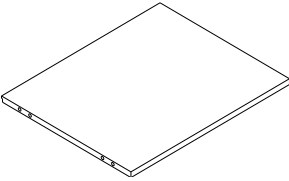
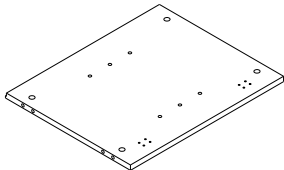
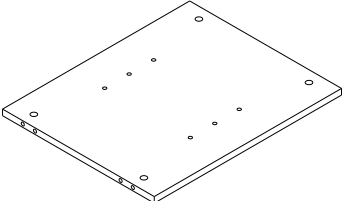
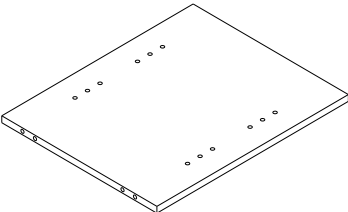
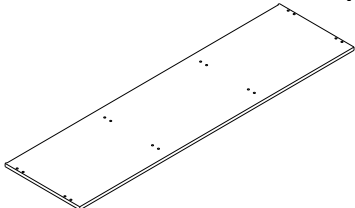
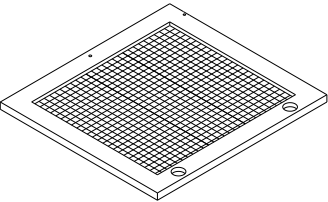
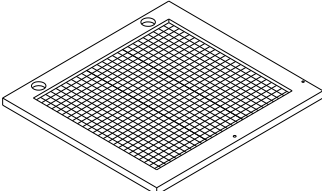
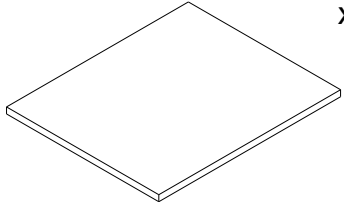
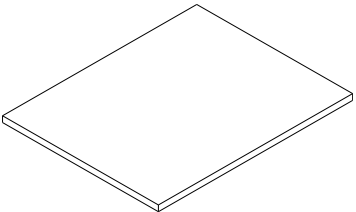
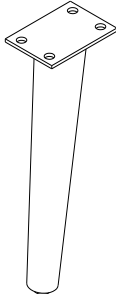
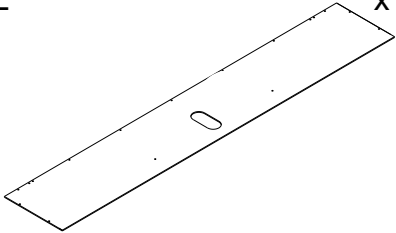
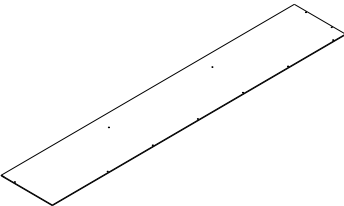

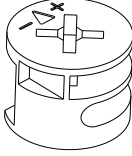
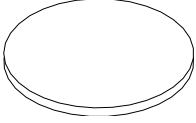
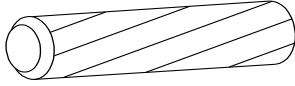
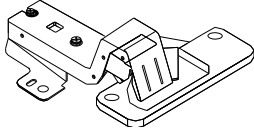
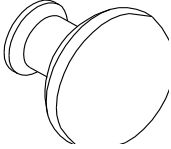

# Assembly | Asamblea | Assemblage

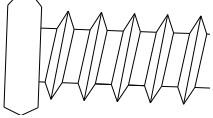
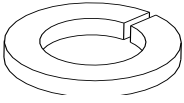
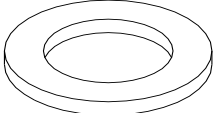
|  |   |   |
|--|---|---|
| <p>A x1</p>  <p>Top panel<br/>Panel superior<br/>Panneau supérieur</p>  | <p>B x1</p>  <p>Left side panel<br/>Panel lateral izquierdo<br/>Panneau latéral gauche</p>       | <p>C x1</p>  <p>Right side panel<br/>Panel lateral derecho<br/>Panneau latéral droit</p>                       |
| <p>D x1</p>  <p>Left middle panel<br/>Panel central izquierdo<br/>Panneau central gauche</p>                  | <p>E x1</p>  <p>Right middle panel<br/>Panel central derecho<br/>Panneau central droit</p>       | <p>F x1</p>  <p>Bottom panel<br/>Panel inferior<br/>Panneau du bas</p>   |
| <p>G x1</p>  <p>Left door panel<br/>Panel de la puerta izquierda<br/>Panneau de porte gauche</p>            | <p>H x1</p>  <p>Right door panel<br/>Panel de la puerta derecha<br/>Panneau de porte droit</p> | <p>I x2</p>  <p>Adjustable shelf (side)<br/>Estante ajustable (lateral)<br/>Tablette ajustable (latérale)</p> |
| <p>J x2</p>  <p>Adjustable shelf (middle)<br/>Estante ajustable (medio)<br/>Tablette ajustable (milieu)</p> | <p>K x4</p>  <p>Leg<br/>Pierna<br/>Jambe</p>   | <p>L x1</p>  <p>Upper back panel<br/>Panel posterior superior<br/>Panneau arrière supérieur</p>              |
| <p>M x1</p>  <p>Lower back panel<br/>Panel posterior inferior<br/>Panneau arrière inférieur</p>             |   |   |

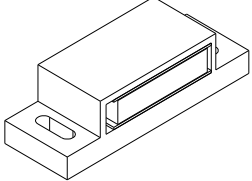
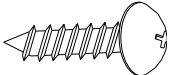
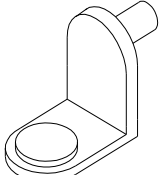
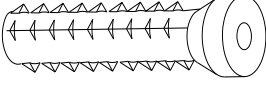
# Assembly | Asamblea | Assemblage

|  |   |  |
|--|---|--|
| <p>1 x16</p>  <p>Cam bolt<br/>Perno de leva<br/>Boulon à came</p>   | <p>2 x16</p>  <p>Cam lock<br/>Bloqueo de la leva<br/>Serrure à came</p>                | <p>3 x16</p>  <p>Cover<br/>Tapa<br/>Couverture</p>                                  |
| <p>4 x16</p>  <p>Wood dowel<br/>Taco de madera<br/>Cheville en bois <math>\phi 8 \times 30 \text{mm}</math></p> | <p>5 x4</p>  <p>Hinge<br/>Bisagra<br/>Charnière</p>                                    | <p>6 x2</p>  <p>Knob<br/>Pomo<br/>Pommeau</p>                                       |
| <p>7 x2</p>  <p>Bolt<br/>Tornillo<br/>Boulon <math>\phi 5/32" \times 25 \text{mm}</math></p>                  | <p>8 x16</p>  <p>Bolt<br/>Tornillo<br/>Boulon <math>\phi 1/4" \times 5/8"</math></p> | <p>9 x16</p>  <p>Spring washer<br/>Arandela de resorte<br/>Rondelle élastique</p> |
| <p>10 x16</p>  <p>Flat washer<br/>Arandela plana<br/>Rondelle plate</p>                                       | <p>11 x1</p>  <p>Allen wrench<br/>Llave Allen<br/>Clé Allen</p>                      | <p>12 x2</p>  <p>Magnet<br/>Imán<br/>Aimant</p>                                   |
| <p>13 x30</p>  <p>Screw<br/>Tornillo<br/>Vis <math>\phi 3 \times 15 \text{mm}</math></p>                      | <p>14 x16</p>  <p>Shelf pin<br/>Estante pin<br/>Goupille d'étagère</p>               | <p>15 x4</p>  <p>Anchor<br/>Ancla<br/>Ancre</p>                                   |

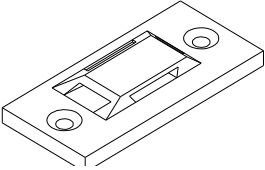
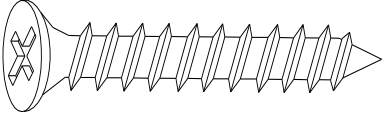
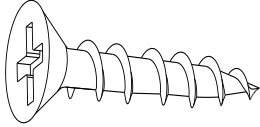

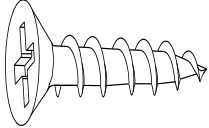
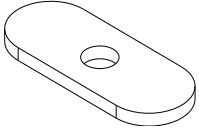
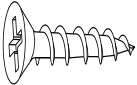
# Assembly | Asamblea | Assemblage

|  |   |  |
|--|---|--|
| <p>16 <span style="float: right;">x4</span></p>  <p>Bracket<br/>Soporte<br/>Support</p>   | <p>17 <span style="float: right;">x4</span></p>  <p>Screw<br/>Tornillo<br/>Vis <span style="float: right;"><math>\phi 8 \times 38 \text{mm}</math></span></p>   | <p>18 <span style="float: right;">x4</span></p>  <p>Screw<br/>Tornillo<br/>Vis <span style="float: right;"><math>\phi 8 \times 15 \text{mm}</math></span></p> |
| <p>19 <span style="float: right;">x2</span></p>  <p>Tie<br/>Lazo<br/>L'attache</p>  | <p>20 <span style="float: right;">x24</span></p>  <p>Screw<br/>Tornillo<br/>Vis <span style="float: right;"><math>\phi 3.5 \times 15 \text{mm}</math></span></p> | <p>21 <span style="float: right;">x2</span></p>  <p>Magnet plate<br/>Placa de imán<br/>Plaque magnétique</p>  |
| <p>22 <span style="float: right;">x2</span></p>  <p>Screw<br/>Tornillo<br/>Vis <span style="float: right;"><math>\phi 3.5 \times 12 \text{mm}</math></span></p> |   |  |

# Assembly | Asambla | Assemblage

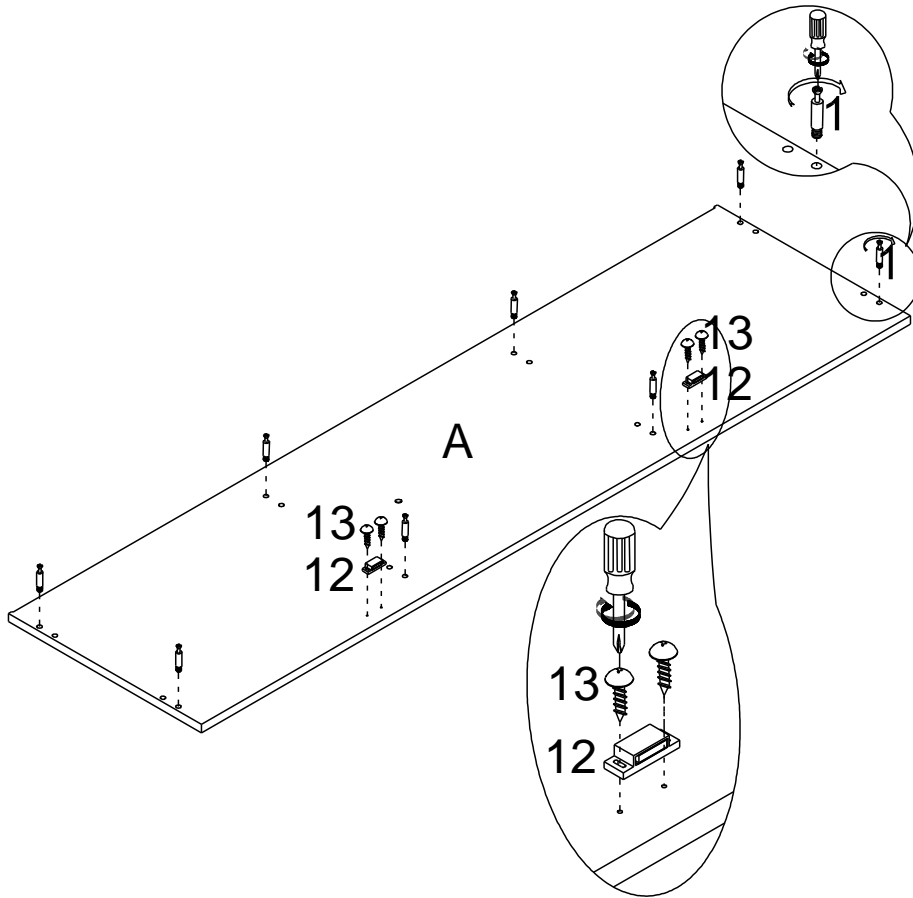



1

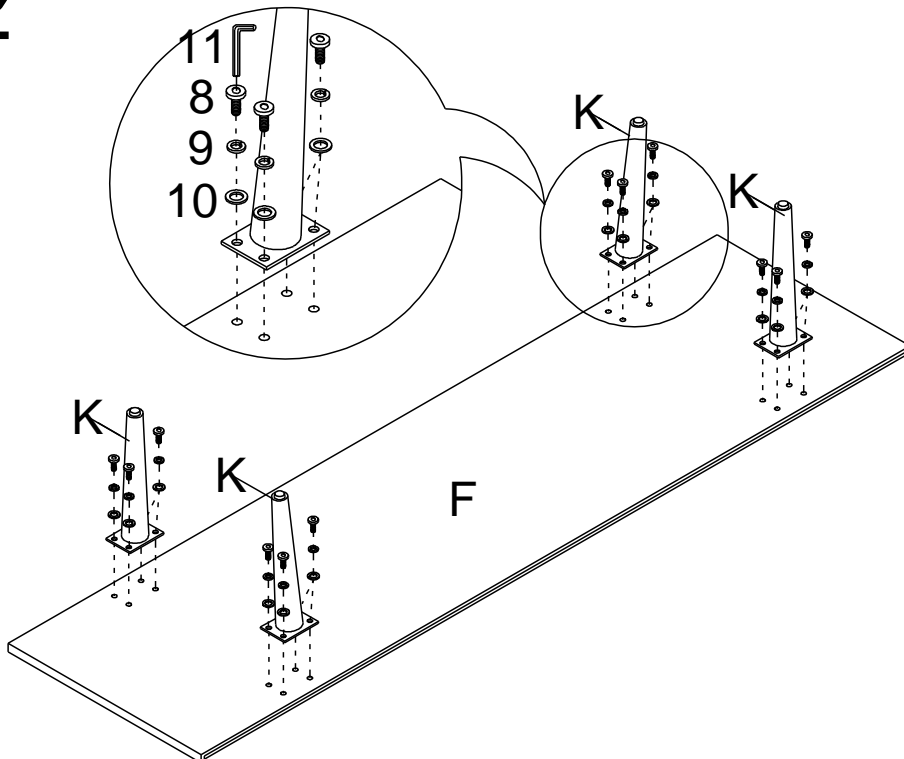

|    |   |    |
|----|---|----|
| 1  |  | X8 |
| 12 |  | X2 |
| 13 |  | X4 |

2



|    |   |     |
|----|---|-----|
| 8  |  | X16 |
| 9  |  | X16 |
| 10 |  | X16 |
| 11 |  | X1  |

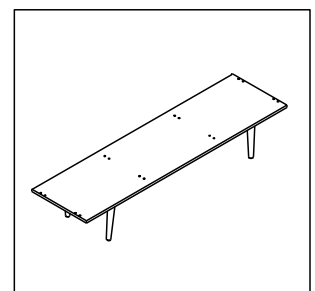

# Assembly | Asambla | Assemblage

3

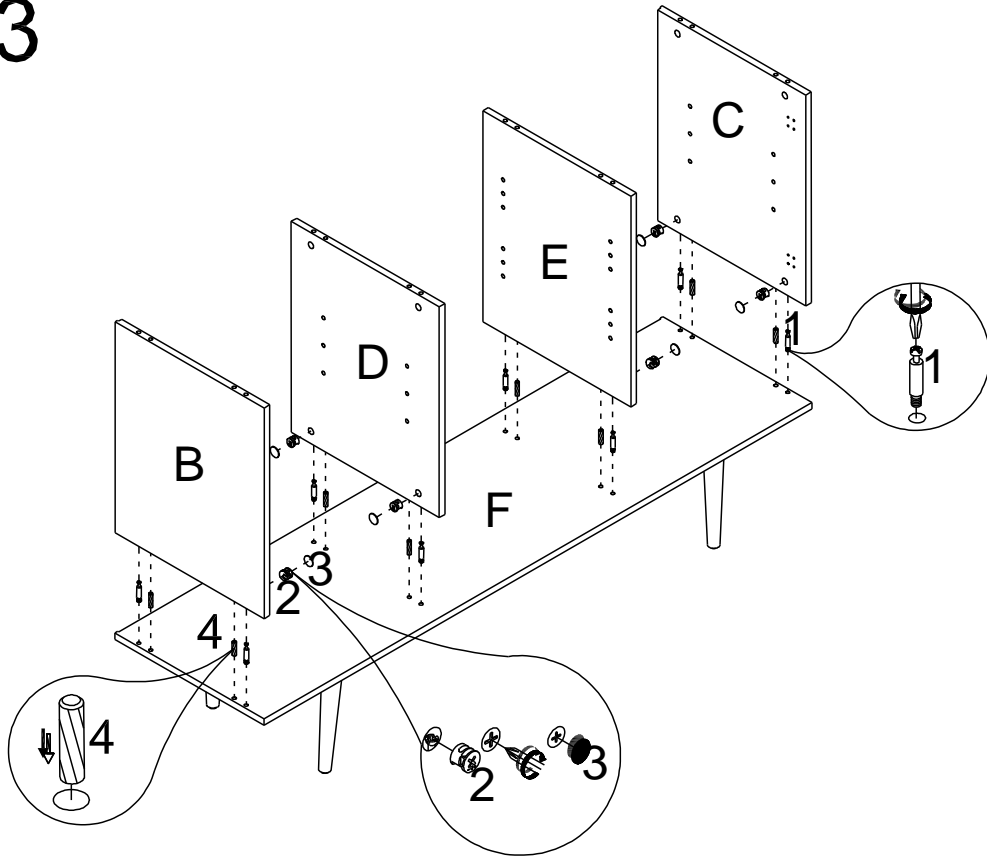

|   |  |    |
|---|--|----|
| 1 |  | X8 |
| 2 |  | X8 |
| 3 |  | X8 |
| 4 |  | X8 |

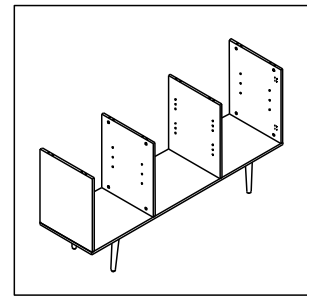

4

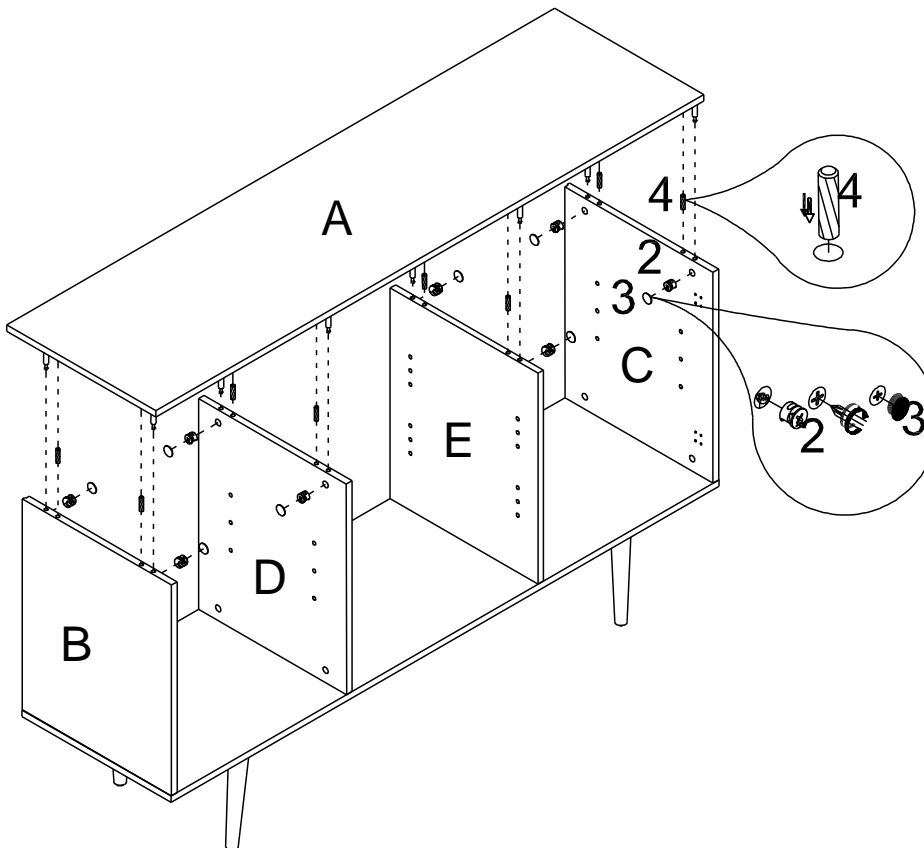

|   |  |    |
|---|--|----|
| 2 |  | X8 |
| 3 |  | X8 |
| 4 |  | X8 |

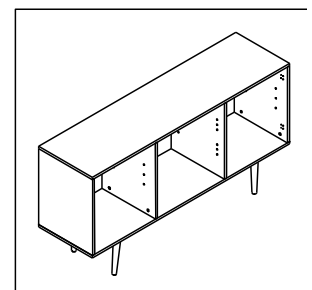





# Assembly | Asambla | Assemblage

5

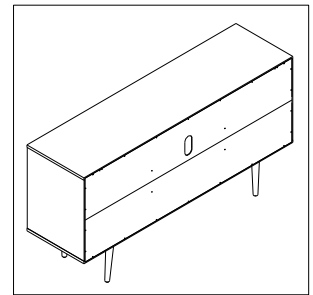
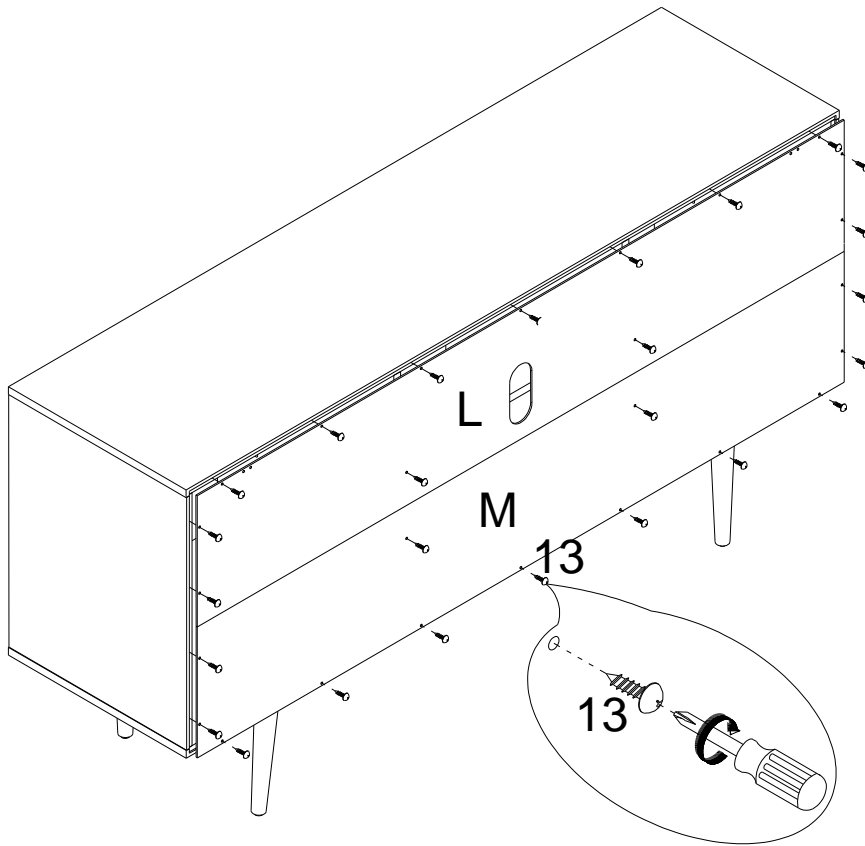
|    |   |     |
|----|---|-----|
| 13 |  | X26 |
|----|---|-----|



6

|    |   |     |
|----|---|-----|
| 14 |  | X16 |
|----|---|-----|

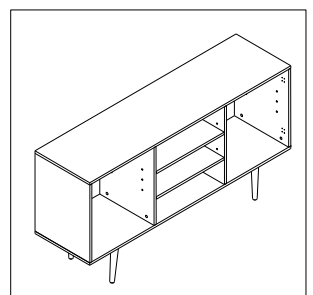
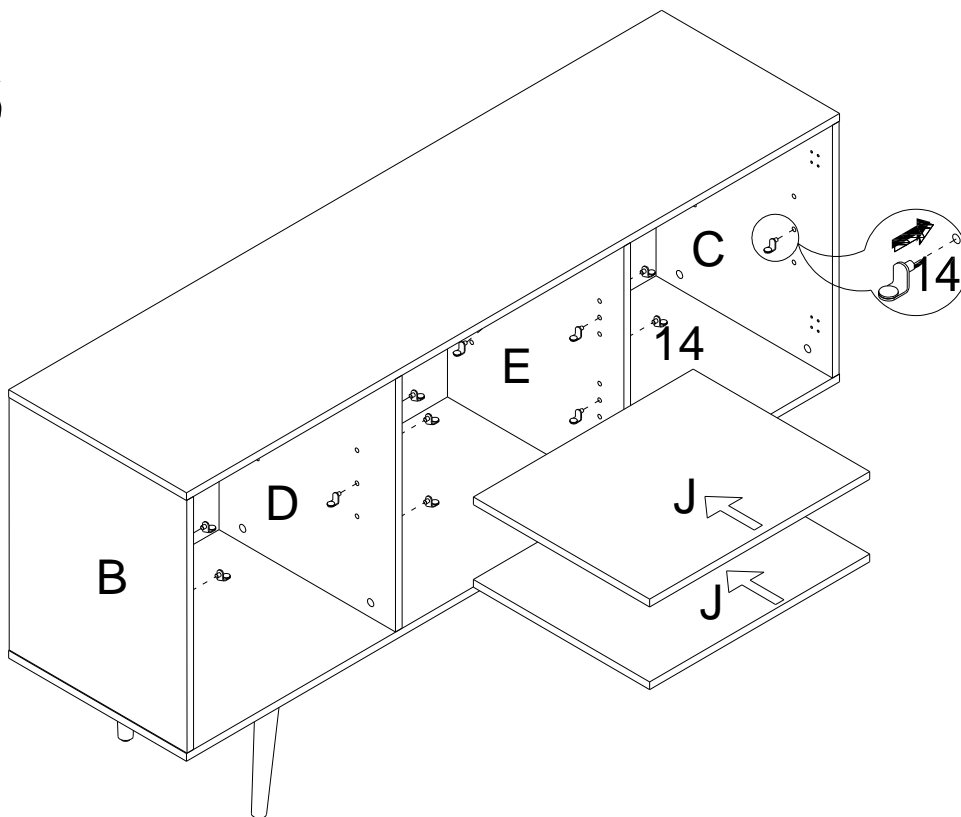

# Assembly | Asambla | Assemblage

7

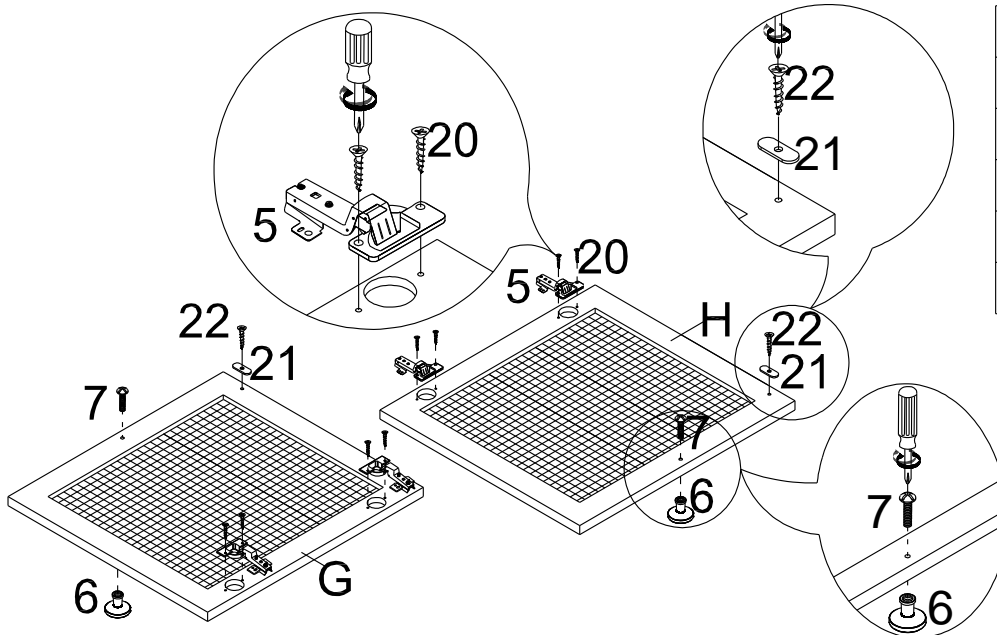

|    |  |    |
|----|--|----|
| 5  |  | X4 |
| 6  |  | X2 |
| 7  |  | X2 |
| 20 |  | X8 |
| 21 |  | X2 |
| 22 |  | X2 |

8

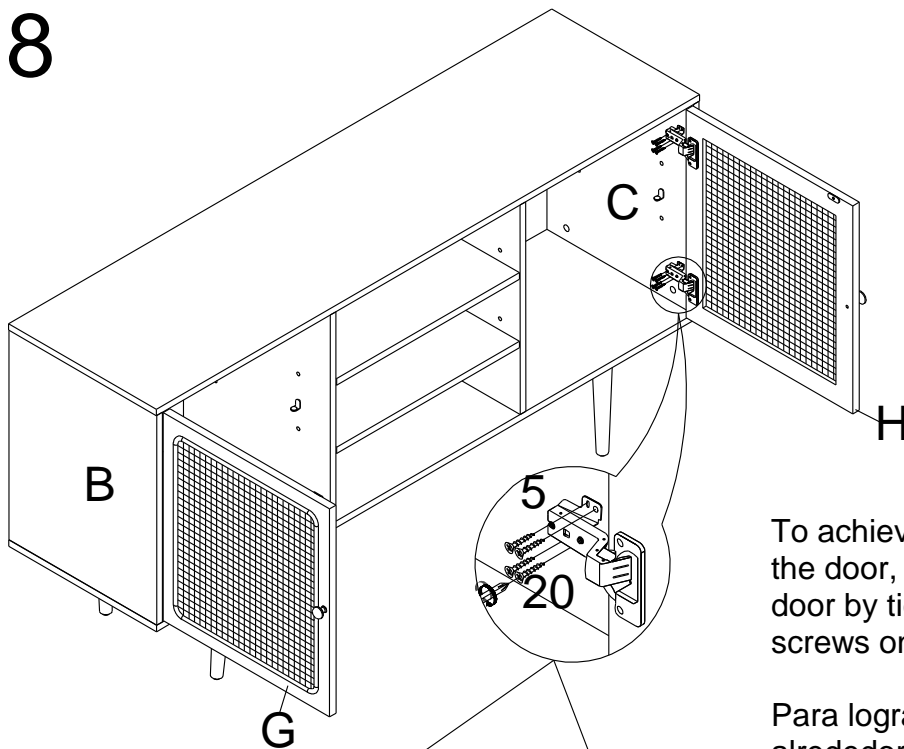

|    |  |     |
|----|--|-----|
| 20 |  | X16 |
|----|--|-----|

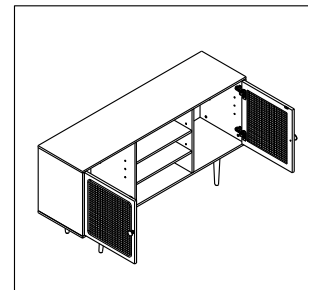

To achieve uniform clearance around the door, you may need to adjust the door by tightening or loosening the two screws on the hinge itself.

Para lograr un espacio uniforme alrededor de la puerta, es posible que deba ajustar la puerta apretando o aflojando los dos tornillos de la bisagra.

Pour obtenir un jeu uniforme autour de la porte, vous devrez peut-être ajuster la porte en serrant ou en desserrant les deux vis de la charnière.

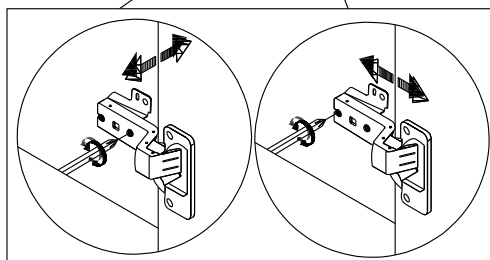

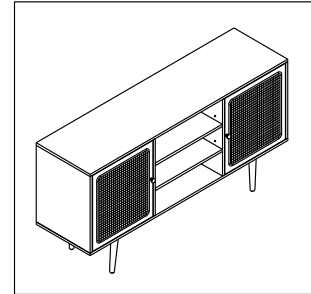
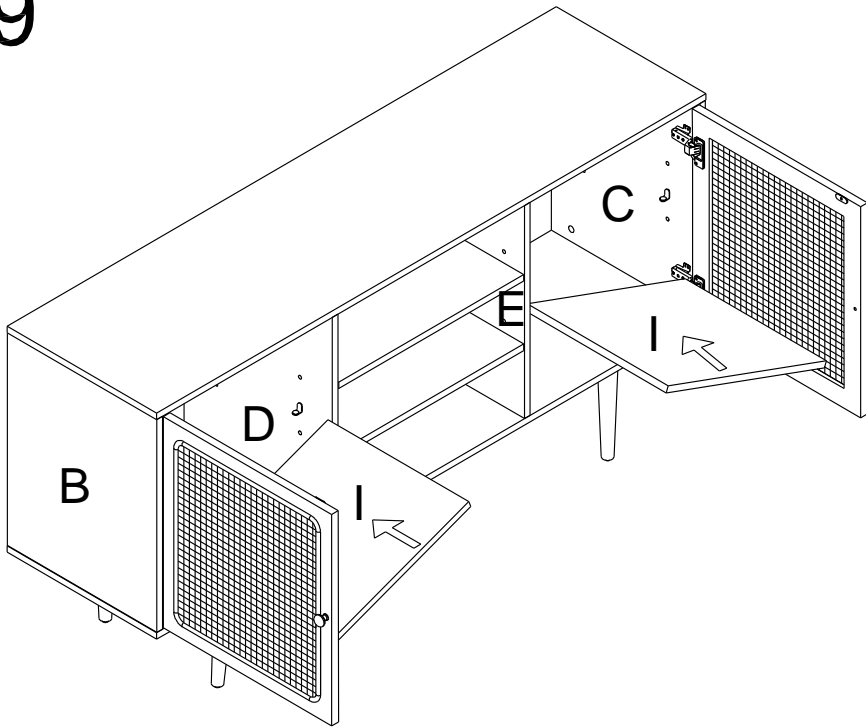

# Assembly | Asambla | Assemblage

9

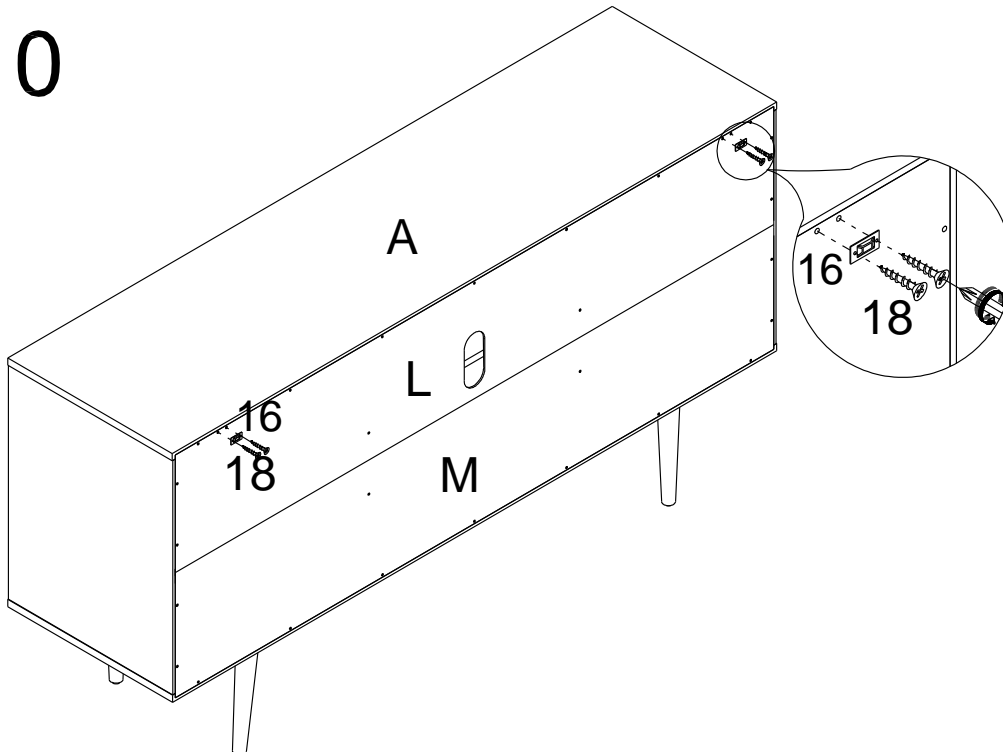

10



|    |   |    |
|----|---|----|
| 16 |  | X2 |
| 18 |  | X4 |

# Assembly | Asambllea | Assemblage

11

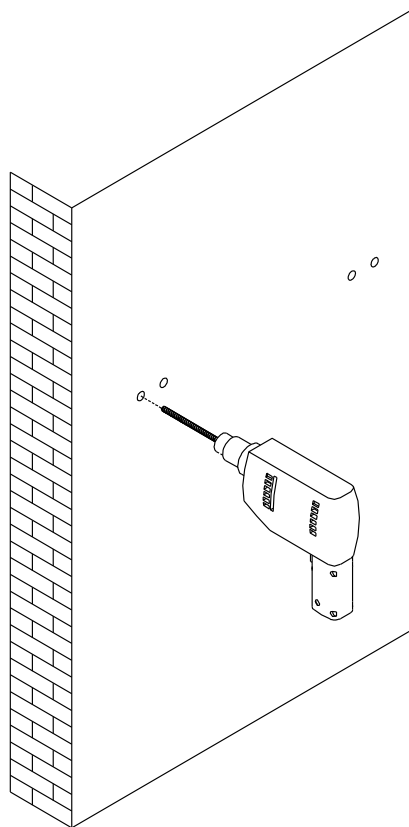

12

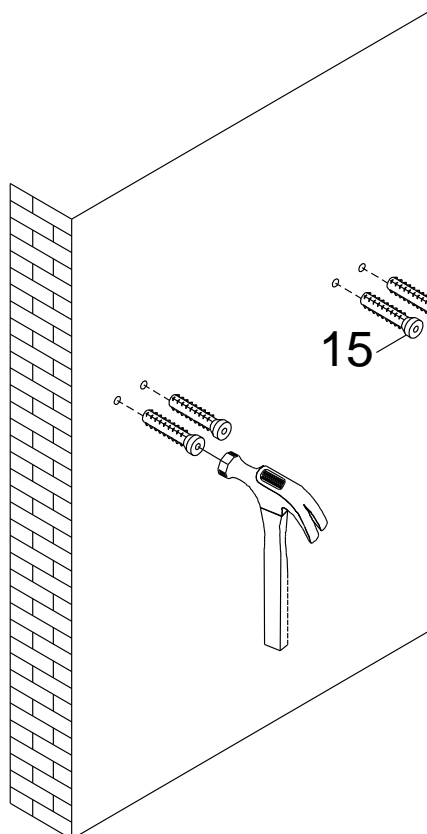



|    |   |    |
|----|---|----|
| 15 |  | X4 |
|----|---|----|

# Assembly | Asambla | Assemblage

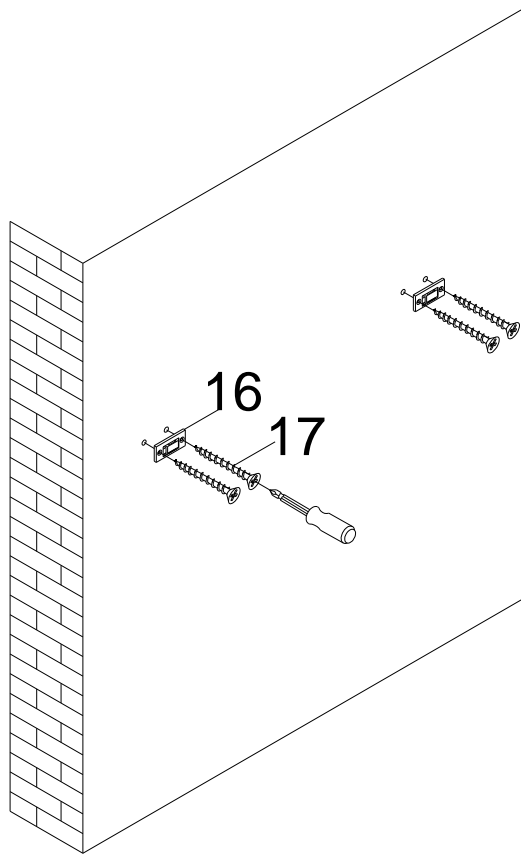
## 13



|    |   |    |
|----|---|----|
| 16 |  | X2 |
| 17 |  | X4 |

## 14

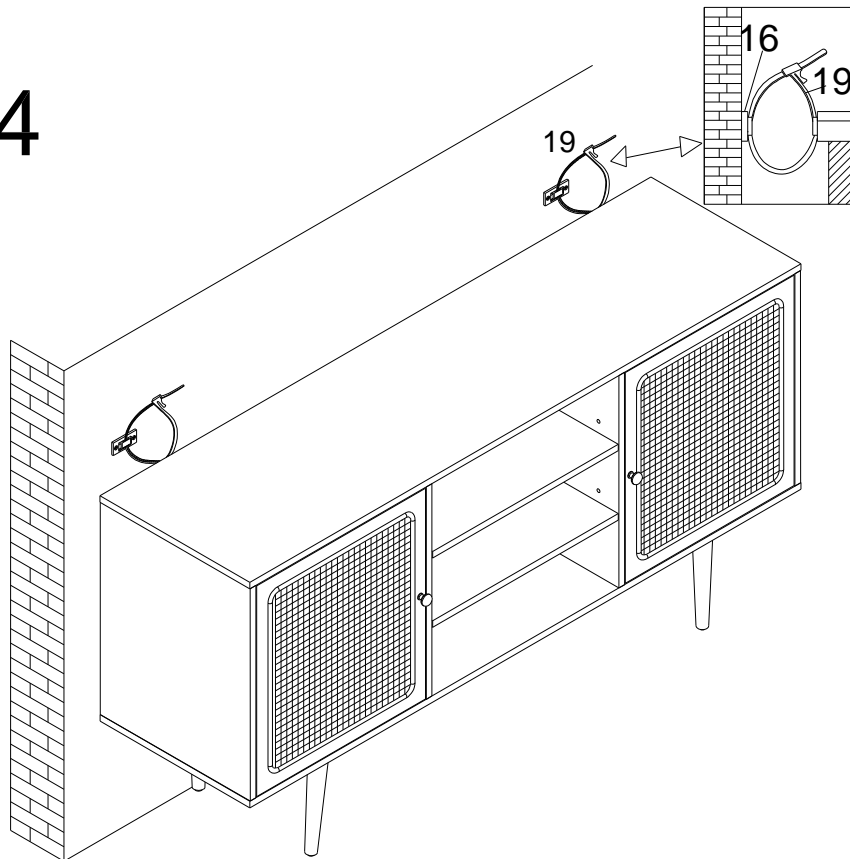

|    |   |    |
|----|---|----|
| 19 |  | X2 |
|----|---|----|

Anti-tipping hardware must be used for this product to avoid tipping and injury.

Se debe usar hardware antivuelco para este producto para evitar que se vuelque y se lastime.

Une quincaillerie anti-basculement doit être utilisée pour ce produit afin d'éviter le basculement et les blessures.

# Assembly | Asambla | Assemblage

## 15

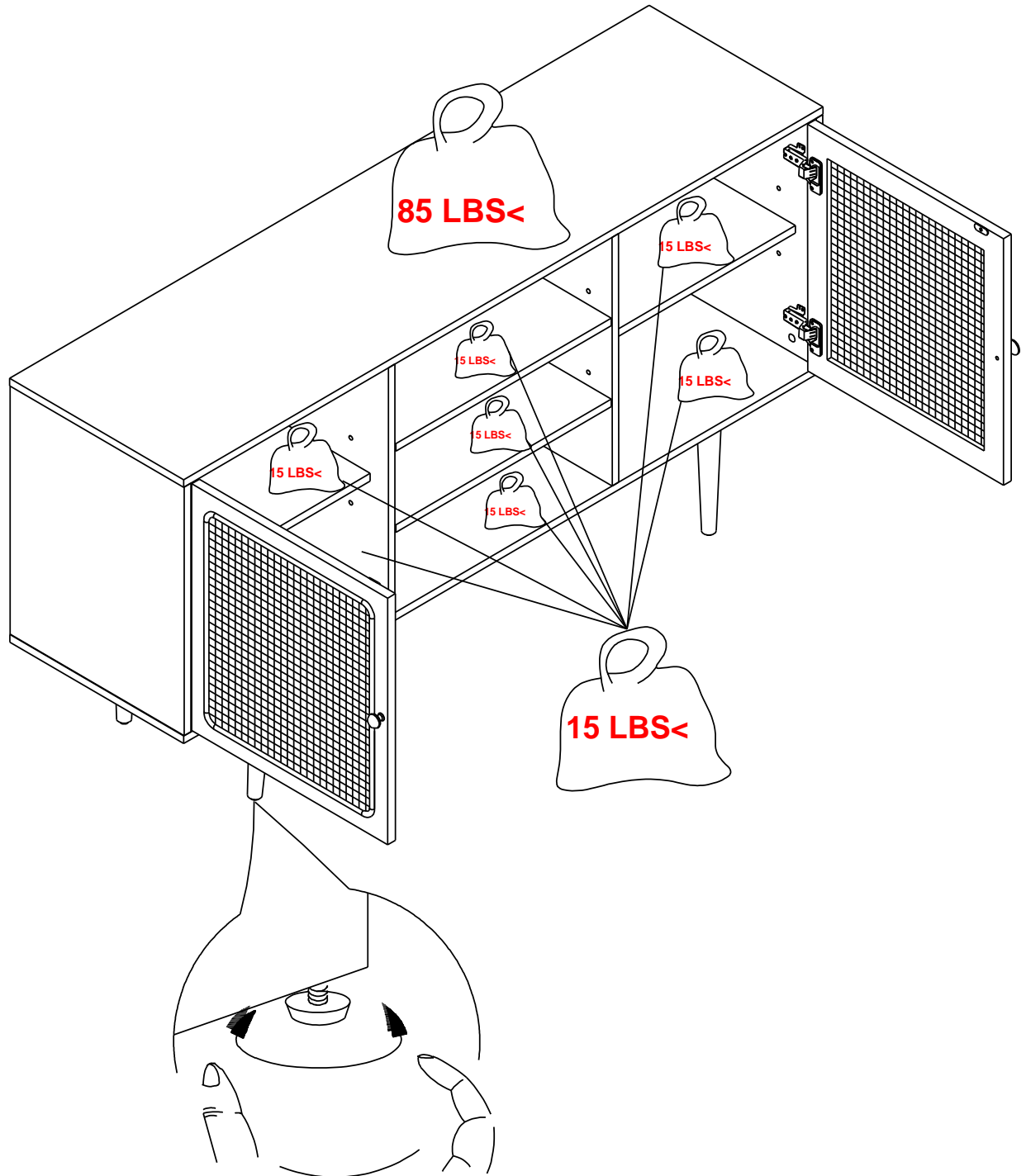

# Assembly | Asamblea | Assemblage

**May We Help You?**  
**800.633.5096**

Please have this information ready when you call:

- Item Number
- PO #
- Purchaser Name
- Place of Purchase
- Purchase Date
- Date Product Arrived

Immediately examine this product carefully. Any request for missing or damaged part replacement must be received within 90 days of your receipt of the product. Requests for replacement parts, if available, will be honored within this time frame. Parts will not be available for items arriving fully assembled. We do not recommend modifying products and we are not responsible for any damages due to product modifications. If damages or missing parts are not reported within 90 days of receiving the product, we are under no obligation to provide parts or replacement merchandise. For product issues, please contact customer service at 800-633-5096 (toll-free) Mon-Fri 8:30am – 5pm CST. Please ask for a customer service representative for issues involving damages or replacement parts. Please ask for a technical assistance representative for any issues related to product assembly/ construction. Regarding product returns, please contact the retailer from whom you purchased the product.

Please note, for items purchased in a retail store, you will need to contact the retailer for all part needs.

Products purchased at garage sales or discount stores are sold as-is and are not covered by the above warranty.

**¿Podemos ayudarle?**  
**800.633.5096**

Tenga a mano esta información cuando llame:

- Número de artículo
- PO #
- Nombre del comprador
- Lugar de compra
- Fecha de compra
- Fecha en que llegó el producto

Inmediatamente examine este producto con cuidado. Cualquier solicitud de reemplazo de piezas faltantes o dañadas debe recibirse dentro de los 90 días posteriores a la recepción del producto. Las solicitudes de repuestos, si están disponibles, serán atendidas dentro de este marco de tiempo. Las piezas no estarán disponibles para los artículos que lleguen completamente ensamblados. No recomendamos modificar los productos y no nos hacemos responsables de los daños debidos a las modificaciones del producto. Si no se informan daños o piezas faltantes dentro de los 90 días de haber recibido el producto, no estamos obligados a proporcionar piezas o productos de reemplazo. Para problemas con el producto, comuníquese con el servicio al cliente al 800-633-5096 (sin cargo) de lunes a viernes, de 8:30 a. M. A 5 p.m. CST. Solicite a un representante de servicio al cliente si tiene problemas con daños o piezas de repuesto. Solicite un representante de asistencia técnica para cualquier problema relacionado con el montaje / construcción del producto. Con respecto a las devoluciones de productos, comuníquese con el vendedor al que le compró el producto.

Tenga en cuenta que, para los artículos comprados en una tienda minorista, deberá comunicarse con el minorista para todas las necesidades de piezas.

Los productos comprados en las ventas de garaje o tiendas de descuento se venden tal como están y no están cubiertos por la garantía anterior.

**Pouvons-nous vous aider?**  
**800.633.5096**

Veillez avoir cette information à portée de main lorsque vous appelez:

- Numéro d'article
- PO #
- Nom de l'acheteur
- Lieu d'achat
- Date d'achat
- Date d'arrivée du produit

Immédiatement examiner ce produit soigneusement. Toute demande de remplacement de pièce manquante ou endommagée doit être reçue dans les 90 jours suivant la réception de votre produit. Les demandes de pièces de rechange, si elles sont disponibles, seront honorées dans ce délai. Les pièces ne seront pas disponibles pour les articles arrivant complètement assemblés. Nous ne recommandons pas de modifier les produits et nous ne sommes pas responsables des dommages causés par des modifications du produit. Si les dommages ou les pièces manquantes ne sont pas signalés dans les 90 jours suivant la réception du produit, nous ne sommes pas tenus de fournir des pièces ou des produits de remplacement. En cas de problème avec le produit, veuillez contacter le service clientèle 800-633-5096 (sans frais) du lundi au vendredi de 8h30 à 17h, heure de Paris. S'il vous plaît demander à un représentant du service clientèle pour les problèmes impliquant des dommages ou des pièces de rechange. Veuillez demander à un représentant de l'assistance technique de résoudre tout problème lié à l'assemblage / la construction du produit. En ce qui concerne les retours de produits, veuillez contacter le détaillant chez qui vous avez acheté le produit.

Veillez noter que pour les articles achetés dans un magasin de détail, vous devrez contacter le détaillant pour tous les besoins en pièces.

Les produits achetés dans les vide-greniers ou les magasins à prix réduits sont vendus tels quels et ne sont pas couverts par la garantie ci-dessus.