

VIZIO

Quantum Pro Smart TV
User Manual

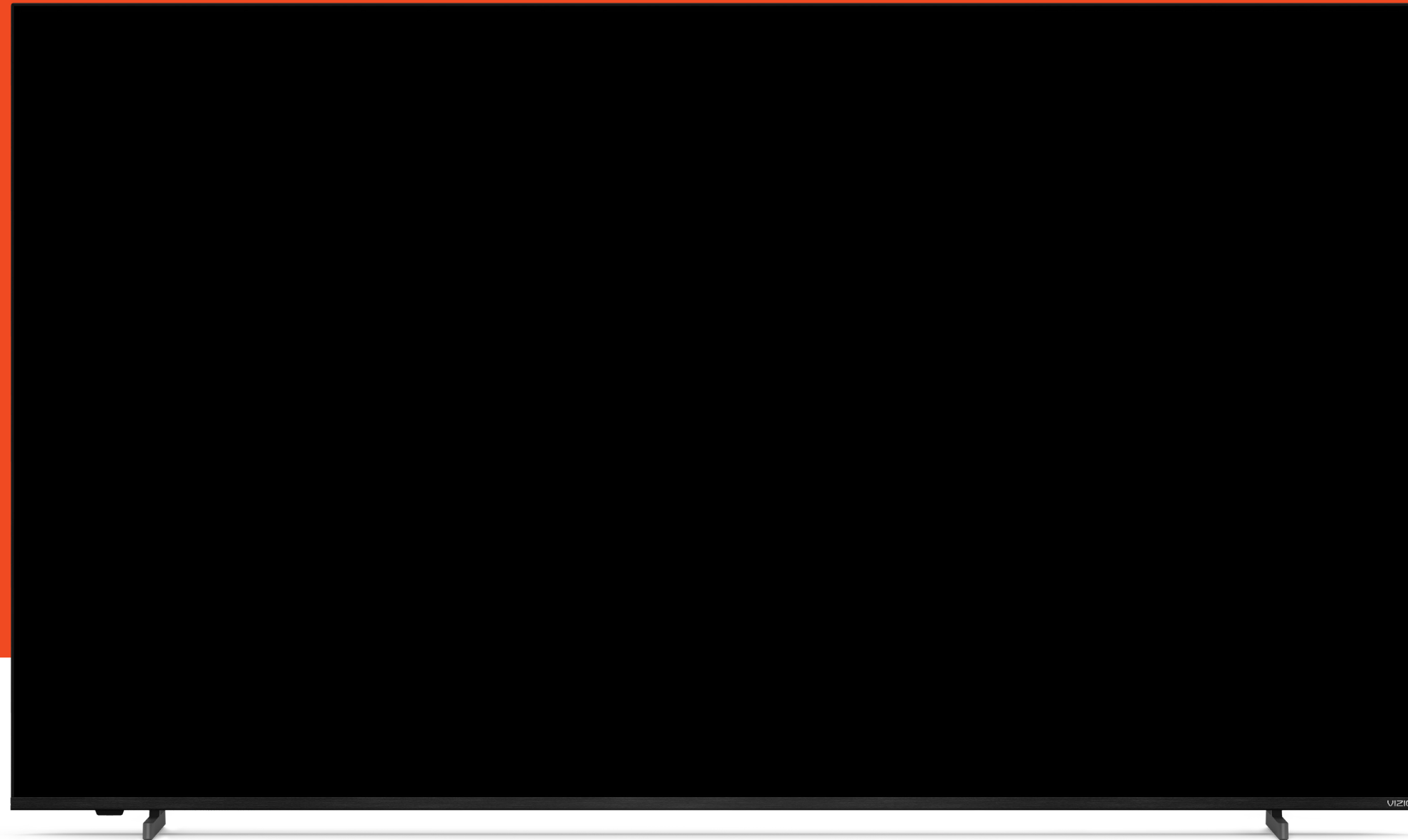

Models:

VQP65C-84 & VQP75C-84

Table of Contents

Getting to Know Your TV	7
Front Panel	7
Power/Input Button	7
Rear Panel	8
Wall-mounting the TV	10
Attaching a VIZIO soundbar to the dual-height stand	11
Using the remote	12
Using the Voice Remote	13
Completing the First-Time Setup	14
VIZIO Smart TV Platform	15
What is the VIZIO Smart TV Platform?	15
Launching the VIZIO Smart TV Platform	15
What you can do with the VIZIO Smart TV Platform	15
Controlling your TV with the VIZIO Mobile App	15
WatchFree+	16
What is WatchFree+?	16
What you can do with WatchFree+	16
How to Launch WatchFree+	16
Product Registration and Technical Support	17
Help Topics	18
Specifications	20
Regulatory Information	21
Limited Warranty	22
Legal Information	24

THANK YOU FOR CHOOSING VIZIO

And congratulations on your new VIZIO TV!

To get the most out of your new VIZIO product, read these instructions before using your product and retain them for future reference. Be sure to inspect the package contents to ensure there are no missing or damaged parts.

PRODUCT REGISTRATION

To purchase or inquire about accessories and installation services for your VIZIO product, visit our website at vizio.com.

We recommend that you register your VIZIO product at: vizio.com/product-registration.



TIP: When you see this symbol, please read the accompanying helpful tip.



WARNING: When you see this symbol, please read the accompanying important warning or notice. It is intended to alert you to the presence of important operating instructions.

Color Text — This is the TV menu feature you should be selecting.

Grey Text — This is an action for you to complete, such as entering in a name.

> — The arrow sign shows the flow of the steps you should take.

1. Lists additional steps you can take for each setting.
- Bullets give more detailed information about each feature.

WHEN READING THIS MANUAL

IMPORTANT SAFETY INSTRUCTIONS

Your TV is designed and manufactured to operate within defined design limits. Misuse may result in electric shock or fire. To prevent your TV from being damaged, the following instructions should be observed for the installation, use, and maintenance of your TV. Read the following safety instructions before operating your TV. Keep these instructions in a safe place for future reference.

- To reduce the risk of electric shock or component damage, switch off the power before connecting other components to your TV.
- Heed all warnings.
- Follow all instructions.
- Do not use this TV near water.
- Clean only with dry cloth.
- Do not block any ventilation openings. Install in accordance with the manufacturer's instructions.
- Do not install near any heat sources such as radiators, heat registers, stoves, or other appliances (including amplifiers) that produce heat.
- Do not defeat the safety purpose of the polarized or grounding-type plug. A polarized plug has two blades with one wider than the other. A grounding type plug has two blades and a third grounding prong. The wide blade or the third prong are provided for your safety. If the provided plug does not fit into your outlet, consult an electrician for replacement of the obsolete outlet.
- Protect the power cord from being walked on or pinched particularly at the ends where the plug is located, near convenience receptacles, or where they exit from the TV.
- Only use attachments/accessories specified by the manufacturer.
- Use only with the stand, tripod, or bracket specified by the manufacturer, or sold with the TV.
- When a cart is used, use caution when moving the cart/TV combination to avoid injury from tip-over.
- Unplug the power cord before cleaning your TV.
- Refer all servicing to qualified service personnel. Servicing is required when the TV has been damaged in any way, such as power-supply cord or plug is damaged, liquid has been spilled or objects have fallen into the TV, the TV has been exposed to rain or moisture, does not operate normally, or has been dropped.



- **CAUTION:** Always use a power outlet that is properly grounded.
- Unplug your TV during a lightning storm or when it will not be used for long period of time. This will protect your TV from damage due to power surges.
- When moving your TV from an area of low temperature to an area of high temperature, condensation may form in the housing. Wait before turning on your TV to avoid causing fire, electric shock, or component damage.
- A distance of at least three feet should be maintained between your TV and any heat source, such as a radiator, heater, oven, amplifier, etc. Do not install your TV close to smoke. Operating your TV close to smoke or moisture may cause fire or electric shock.
- Slots and openings in the back and bottom of the TV are provided for ventilation. To ensure reliable operation of your TV and to protect it from overheating, be sure these openings are not blocked or covered. Do not place your TV in a bookcase or cabinet unless proper ventilation is provided.
- Never push any object into the slots and openings on your TV. Do not place any objects on the top of your TV. Doing so could short circuit parts causing a fire or electric shock. Never spill liquids on your TV.
- Your TV should be operated only from the type of power source indicated on the label. If you are not sure of the type of power supplied to your home, consult your dealer or local power company.
- Do not apply pressure or throw objects at your TV. This may compromise the integrity of the TV. The manufacturer's warranty does not cover user abuse or improper installations.
- The power cord must be replaced when using different voltage than the voltage specified. For more information, contact your dealer.
- When connected to a power outlet, power is always flowing into your TV. To totally disconnect power, unplug the power cord.
- The lightning flash with arrowhead symbol within an equilateral triangle is intended to alert the user to the presence of un-isolated, dangerous voltage within the inside of your TV that may be of sufficient magnitude to constitute a risk of electric shock to persons.
- Do not overload power strips and extension cords. Overloading can result in fire or electric shock.
- The wall socket should be installed near your TV and easily accessible.
- Only power of the marked voltage can be used for your TV. Any other voltage than the specified voltage may cause fire or electric shock.
- Do not touch the power cord during lightning. To avoid electric shock, avoid handling the power cord during electrical storms.



- Do not attempt to repair or service your TV yourself. Opening or removing the back cover may expose you to high voltages, electric shock, and other hazards. If repair is required, contact your dealer and refer all servicing to qualified service personnel.
- **WARNING:** Keep your TV away from moisture. Do not expose your TV to rain or moisture. If water penetrates into your TV, unplug the power cord and contact your dealer. Continuous use in this case may result in fire or electric shock.
- Do not use your TV if any abnormality occurs. If any smoke or odor becomes apparent, unplug the power cord and contact your dealer immediately. Do not try to repair your TV yourself.
- Avoid using dropped or damaged appliances. If your TV is dropped and the housing is damaged, the internal components may function abnormally. Unplug the power cord immediately and contact your dealer for repair. Continued use of your TV may cause fire or electric shock.
- Do not install your TV in an area with heavy dust or high humidity. Operating your TV in environments with heavy dust or high humidity may cause fire or electric shock.
- Follow instructions for moving your TV. Ensure that the power cord and any other cables are unplugged before moving your TV.
- To prevent injury, this apparatus must be securely attached to the furniture/wall in accordance with the installation instructions.
- Insert batteries in accordance with instructions. Incorrect polarities may cause the batteries to leak which can damage the remote control or injure the operator. Do not expose batteries to excessive heat such as sunlight, fire, etc.
- When unplugging your TV, grab the head of the power plug, not the cord. Pulling on the power cord may damage the wires inside the cord and cause fire or electric shock. When your TV will not be used for an extended period of time, unplug the power cord.
- To reduce risk of electric shock, do not touch the connector with wet hands.
- Do not expose TV to liquids, including dripping or splashing.
- Do not place objects filled with liquid, such as vases, on the TV.
- If the main wall plug or the appliance coupler is disconnected, the disconnected device will remain readily operable upon reconnection to an appropriate power source.

- If any of the following occurs, contact the dealer:
 - The power cord fails or frays.
 - Liquid sprays or any object drops into your TV.
 - Your TV is exposed to rain or other moisture.
 - Your TV is dropped or damaged in any way.
 - The performance of your TV changes substantially.

- **CAUTION:** These servicing instructions are for use by qualified service personnel only. To reduce the risk of electric shock, do not perform any servicing other than that contained in the operating instructions unless you are qualified to do so.



- The lightning flash with arrowhead symbol within an equilateral triangle is intended to alert the user to the presence of uninsulated DANGEROUS VOLTAGE within the product's enclosure that may be of sufficient magnitude to constitute a risk of electrical shock to persons.
- **WARNING:** Exposure to loud sounds can damage your hearing causing hearing loss and tinnitus (ringing or buzzing in the ears). With continued exposure to loud noises, ears may become accustomed to the sound level, which may result in permanent damage to hearing without any noticeable discomfort.
- Install the TV where it cannot be pulled, pushed or knocked over.
- Do not allow children to hang onto the product.
- Store the accessories (remote, batteries, etc.) in a location safely out of the reach of children.
- The American Academy of Pediatrics discourages television viewing for children younger than two years of age.
- **WARNING — Stability Hazard:** A television set may fall, causing serious personal injury or death. Many injuries, particularly to children, can be avoided by taking simple precautions such as:
 - **ALWAYS** use cabinets or stands or mounting methods recommended by the manufacturer of the television set.
 - **ALWAYS** use furniture that can safely support the television set.
 - **ALWAYS** ensure the television set is not overhanging the edge of the supporting furniture.

- **ALWAYS** educate children about the dangers of climbing on furniture to reach the television set or its controls.
- **ALWAYS** route cords and cables connected to your television so they cannot be tripped over, pulled or grabbed.
- **NEVER** place a television set in an unstable location.
- **NEVER** place the television set on tall furniture (for example, cupboards or bookcases) without anchoring both the furniture and the television set to a suitable support.
- **NEVER** place the television set on cloth or other materials that may be located between the television set and supporting furniture.
- **NEVER** place items that might tempt children to climb, such as toys and remote controls, on the top of the television or furniture on which the television is placed.
- If the existing television set is going to be retained and relocated, the same considerations as above should be applied.
- Disposal of a battery into fire or a hot oven, or mechanically crushing or cutting of a battery can result in an explosion.
- Leaving a battery in an extremely high temperature can result in an explosion or the leakage of flammable liquid or gas.
- A battery subjected to extremely low air pressure may result in an explosion or the leakage of flammable liquid or gas.
- **WARNING:** To prevent injury, this apparatus must be securely attached to the furniture/wall in accordance with the installation instructions.

TELEVISION ANTENNA CONNECTION PROTECTION

The TV shall be installed in accordance with the applicable provisions of Article 810 and Article 820.

If an outside antenna/satellite dish or cable system is to be connected to the TV, make sure that the antenna or cable system is electrically grounded to provide some protection against voltage surges and static charges.

Article 810 of the National Electrical Code, ANSI/NFPA 70, provides information with regard to proper grounding of the mast and supporting structure, grounding of the lead-in wire to an antenna discharge unit, size of the grounding conductors, location of antenna discharge unit, connection to grounding electrodes, and requirements of the grounding electrode.

Lightning Protection

For added protection of the TV during a lightning storm or when it is left unattended or unused for long periods of time, unplug the TV from the wall outlet and disconnect the antenna or cable system.

Power Lines

Do not locate the antenna near overhead light or power circuits, or where it could fall into such power lines or circuits. Remember, the screen of the coaxial cable is intended to be connected to earth in the building installation.

Installation of CATV

The installation instructions states the cable distribution system should be grounded (earthed) in accordance with ANSI/NFPA 70, the National Electrical Code (NEC), in particular Section 820.93, Grounding of Outer Conductive Shield of a Coaxial Cable.

Installation of Antenna

The installation instructions states the cable distribution system used for connection to antennas and dishes should be grounded (earthed) in accordance with ANSI/NFPA 70, the National Electrical Code (NEC), in particular Section 810.21, Bonding Conductors and Grounding Electrode Conductors — Receiving Stations.

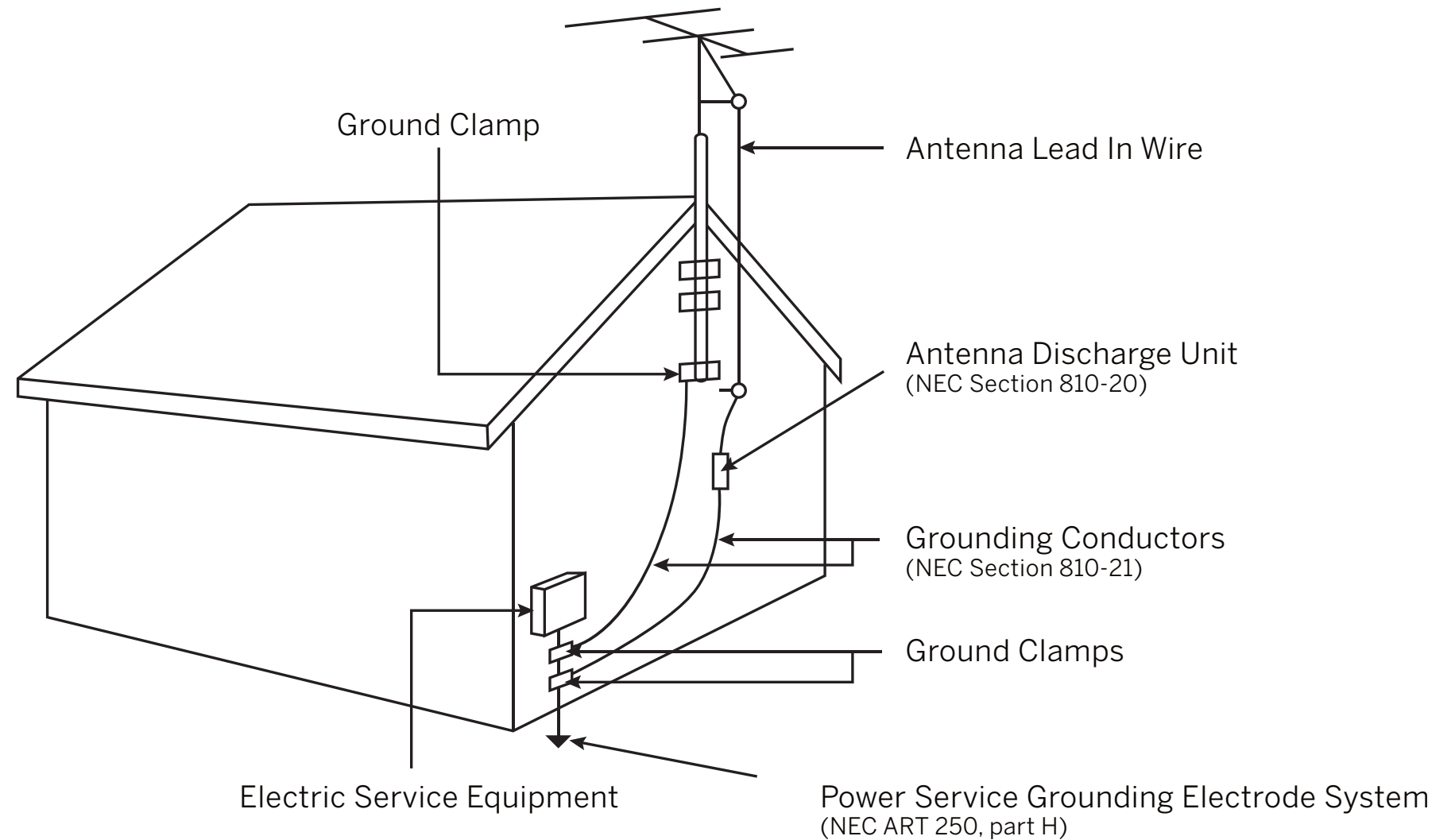

 **Dolby** Vision

 **Dolby** Audio

Dolby, Dolby Vision, Dolby Audio, and the double-D symbol are trademarks of Dolby Laboratories Licensing Corporation. Manufactured under license from Dolby Laboratories. Confidential unpublished works. Copyright © 1992-2022 Dolby Laboratories. All rights reserved.

 **HDMI**[®]
HIGH-DEFINITION MULTIMEDIA INTERFACE

The terms HDMI, HDMI High-Definition Multimedia Interface, HDMI Trade dress and the HDMI Logos are trademarks or registered trademarks of HDMI Licensing Administrator, Inc.

 **dts x**[™]
DTS:X[®] Cinema Quality
Immersive Audio

 **dts**[®]
DTS[®] Virtual:X[™]
Virtualized 3D Sound

For DTS patents, see <http://patents.dts.com>.

Manufactured under license from DTS, Inc or under license from DTS Licensing Limited. DTS, DTS:X, Digital Surround, Virtual:X, TruVolume, the DTS logo and the DTS:X logo are registered trademarks or trademarks of DTS, Inc. in the United States and other countries. © 2021 DTS, Inc. ALL RIGHTS RESERVED.

Getting to Know Your TV

FRONT PANEL

Remote Sensor and Power Indicator

When using the remote, aim it directly at this sensor.

The power indicator flashes on when the TV turns on, then goes out after several seconds.



POWER/INPUT BUTTON

(located under the sensor)

When TV is OFF:

Press to turn On the TV.

When TV is ON:

Press to change to the next input source.

Press and hold (**3 seconds**) and release to turn TV Off.

Press and hold (**12 seconds**) to reset TV to default settings.

REAR PANEL

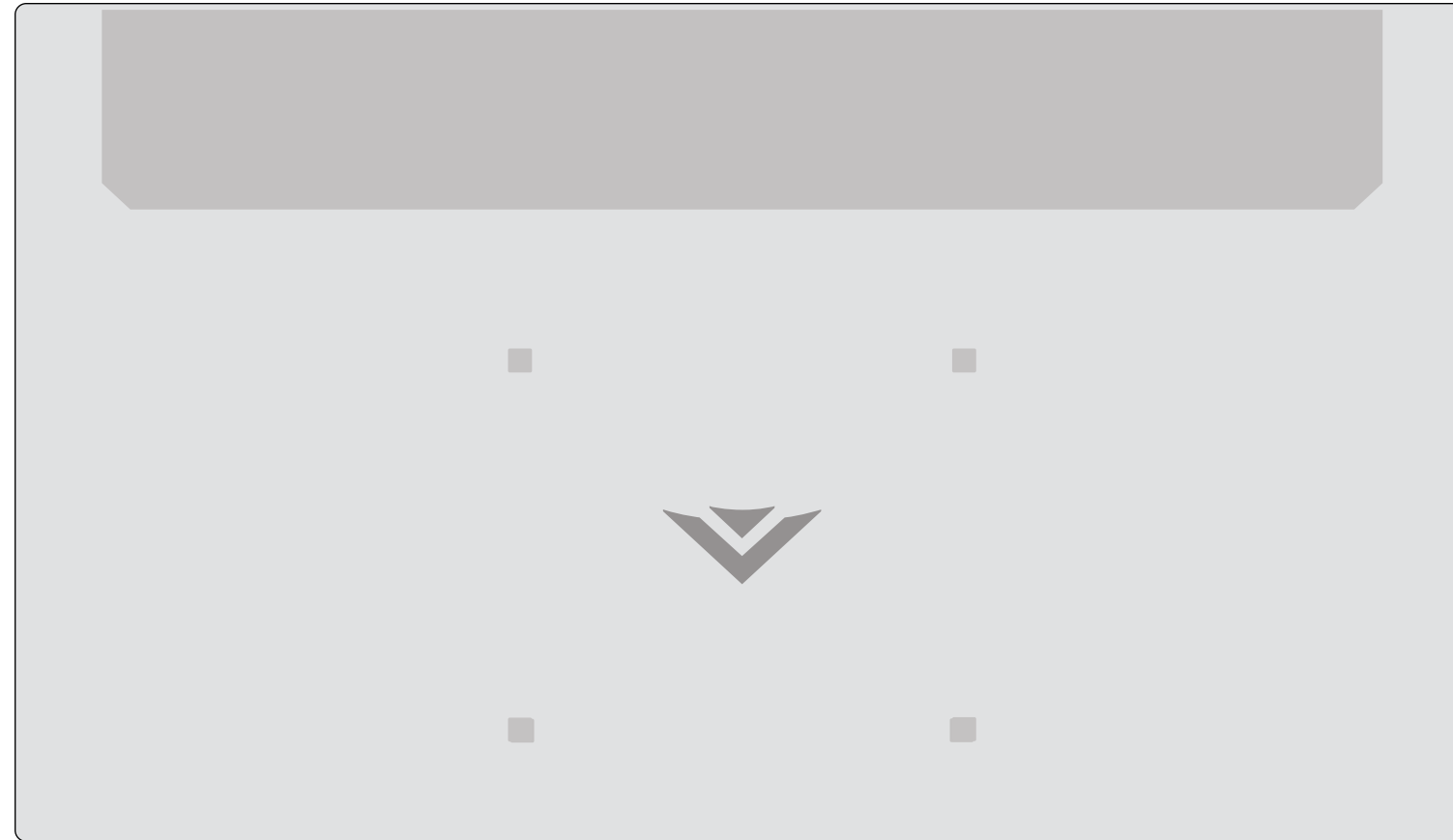

Note: The image shown here is for illustrative purposes only and may be subject to change.
The actual number of ports and their locations may vary, depending on the model.



HDMI

Connect an HDMI device



Optical Audio Out

Connect to an optical/SPDIF audio device, such as home audio receiver



Ethernet

Connect an Ethernet cable to modem/router



Coaxial

Connect to a coaxial cable from cable, satellite, or antenna



USB

Connect a USB thumb drive to play photo, music, or video

Connecting a device — AUDIO & VIDEO CABLE TYPES

Your TV can be used to display output from most devices.

1. Verify that your device has a video port that matches an available port on the TV (HDMI or Coaxial).
2. Connect the appropriate cable (not included) to the TV and the device.
3. Turn the TV and your device on.
4. Set the TV's input to match the connection you used (HDMI-1, HDMI-2, etc.).

HDMI CABLE

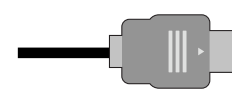

HDMI

COAXIAL CABLE



Coaxial

Connecting a device — AUDIO CABLE TYPES

Your TV can be output sound to an audio device, such as a receiver or soundbar.

1. Verify that your device has an audio port that matches an available port on the TV (HDMI or Optical).
2. Connect the appropriate cable (not included) to the TV and the device.
3. Turn the TV and your device on.

HDMI CABLE

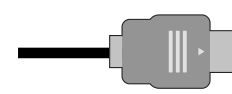

HDMI

OPTICAL/SPDIF CABLE

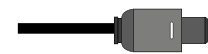

Optical

Note: The actual ports and their locations may vary, depending on the TV model.

WALL MOUNTING THE TV

First you will need a wall mount. Consult the provided table below to find the appropriate mount for your TV.

Be sure the mount you choose is capable of supporting the weight of the TV.

To install your TV on a wall:

1. Disconnect any cables connected to your TV.
2. Place the TV face-down on a clean, flat, stable surface. Be sure the surface is clear of debris that can scratch or damage the TV.
3. If attached, remove the stands by loosening and removing the screws.
4. Attach your TV and wall mount to the wall by carefully following the instructions that came with your mount. Use only with a UL-listed wall mount bracket rated for the weight/load of your TV.



TIP: Installing a TV on a wall requires lifting. To prevent injury or damage to the TV, ask someone to help you.



WARNING: Do not use the screws that are included inside the wall mount holes to mount TV.

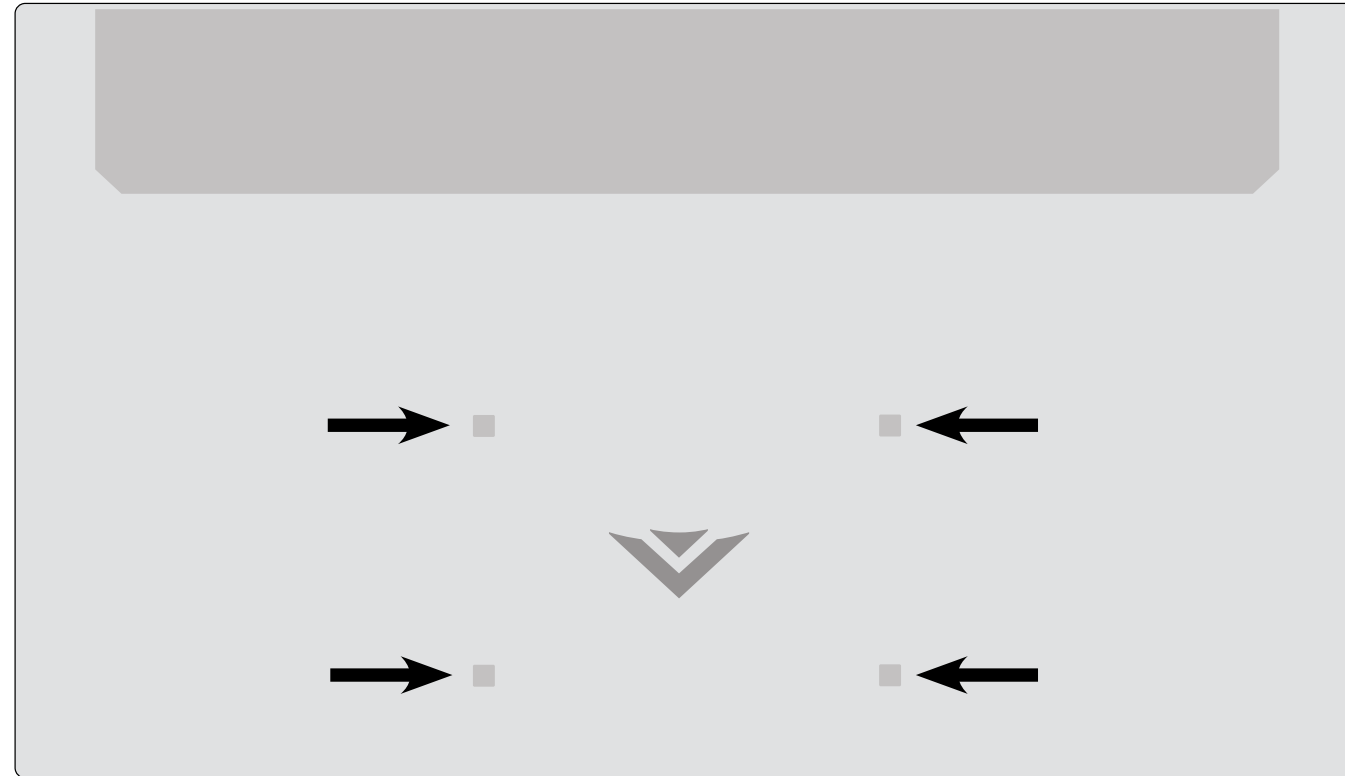

Note: The image shown here is for illustrative purposes only and may be subject to change. The actual number of ports and their locations may vary, depending on the model.

	VQP65C-84	VQP75C-84
Screw Size	M8	M8
# of Screws <i>(not included)</i>	4	4
Hole Depth	15 mm	15 mm
Hole Pattern	400 mm x 300 mm	400 mm x 300 mm
Weight w/o Stand	41.01 lb (18.6 kg)	58.25 lb (26.42 kg)

ATTACHING A VIZIO SOUNDBAR TO THE DUAL-HEIGHT STAND

The dual-purpose stand lets you raise your TV to accommodate a VIZIO Soundbar underneath, or to mount your soundbar directly to your wall-mounted TV for the ultimate streamlined look and finish.

To attach to a traditionally mounted TV:

1. Place the TV face-down on a clean, flat, stable surface. Be sure the surface is clear of debris that could scratch or damage the TV.
Use the included screws with the holes on the feet matching your desired height:

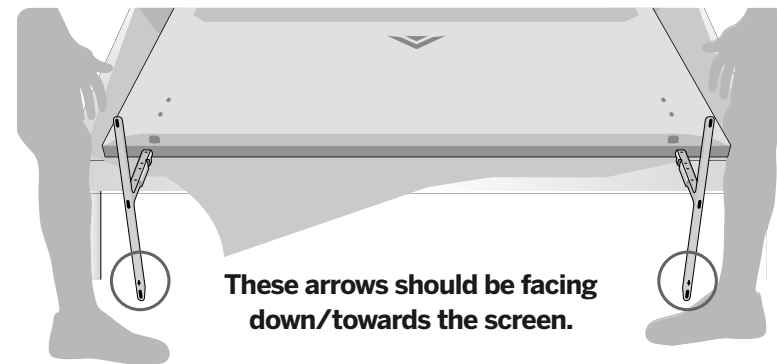

Dual-Height Adjustable Stand

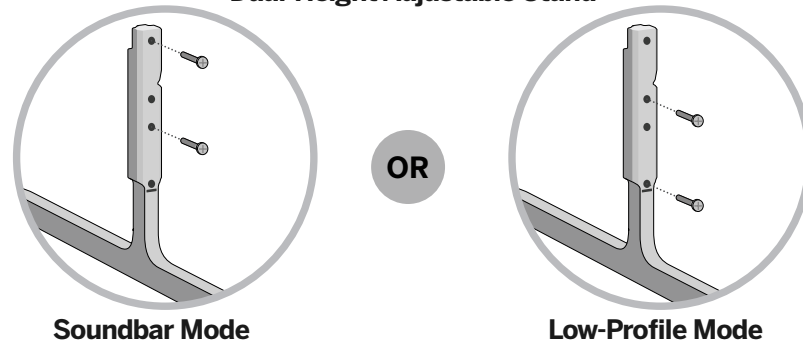

- **Low Profile Mode:** Use the bottom two screw holes. Using this mode with a soundbar may cause the bottom of the TV screen to be blocked.
 - **Soundbar Mode:** Use the top two screw holes. Using this mode will allow the soundbar to sit beneath the TV without obstructing the view of the screen.
2. After setting the mount to your desired Profile Mode, place your TV upright in the desired location.
 3. Rest your soundbar centered between the mount feet.



Low Profile Mode

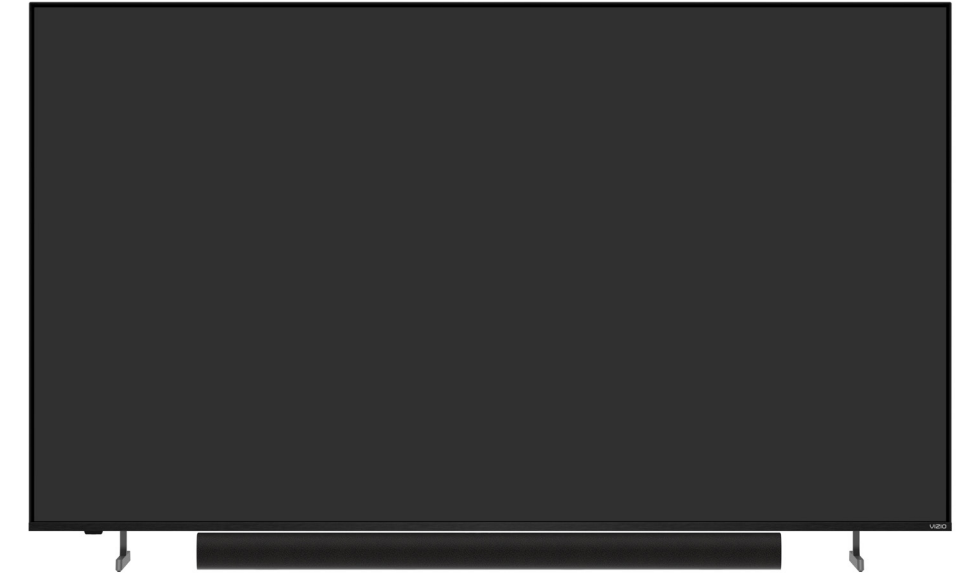

Soundbar Mode

USING THE REMOTE

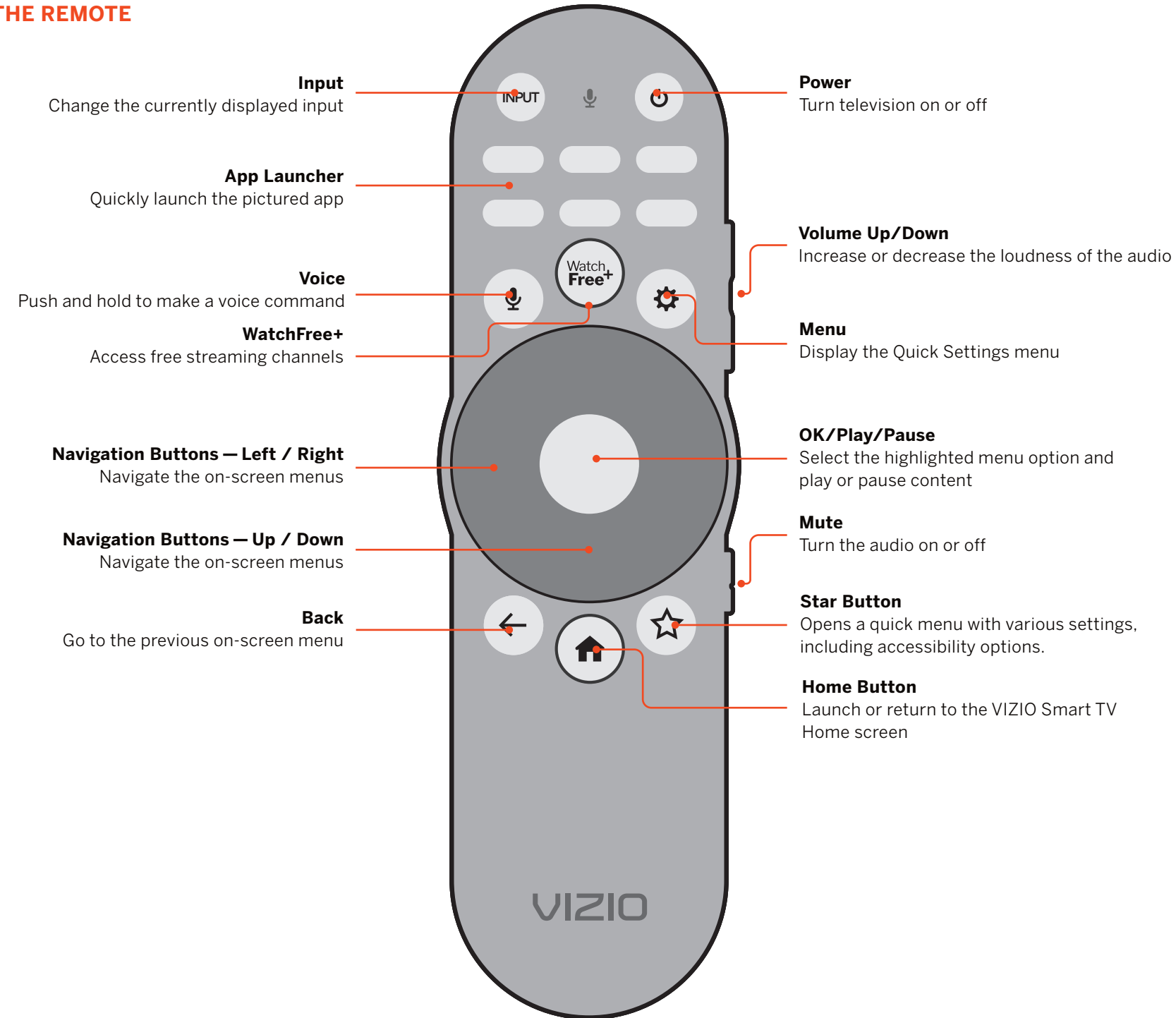

Replacing the Batteries

1. Push and slide the cover down. Then lift the cover to access the battery compartment.
2. Insert two batteries into the remote control. Make sure that the (+) and (-) symbols on the batteries match the (+) and (-) symbols inside the battery compartment.
3. Replace the battery cover and slide to close.

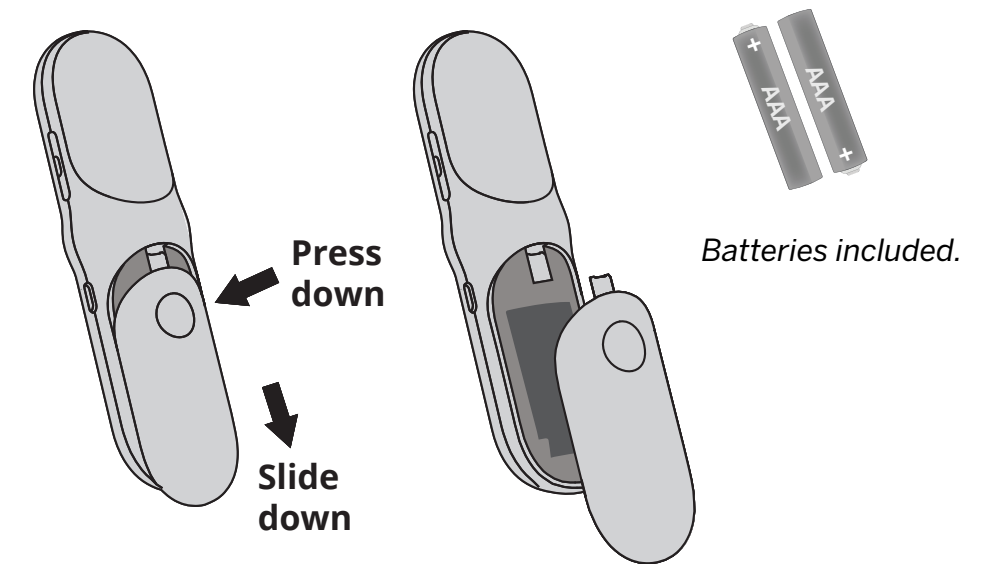

In many places batteries cannot be thrown away or discarded with household waste. Please ensure you properly dispose of your batteries consistent with the laws and/or regulations where you live. For more information please visit: www.vizio.com/environment



WARNING: Keep the remote control batteries away from children. It may cause choking and/or lead to a fire or chemical burn if mishandled. Do not dispose of batteries in fire. Replace only with batteries of the correct type. Risk of fire or explosion if the battery is replaced by an incorrect type.



TIP: When needed, VIZIO recommends replacing the batteries that came with this remote with two, new Duracell 'AAA' alkaline batteries.

**POWER UP WITH
DURACELL**

USING THE VOICE REMOTE

You can easily control your TV with the included Voice Remote.

To pair your remote to the TV:

During first-time setup, your remote should automatically pair to your TV with Bluetooth.

To manually pair:

Press and hold the **MIC**  and **MUTE** buttons to launch pairing mode.



TIP: The voice remote must be within close enough range of the TV to pair properly.

How to use the voice control:

1. Push and hold the **MIC**  button while speaking a command.

Here are some phrases you can say:



"Find free comedy movies."



"Launch WatchFree+."



"Lower volume to 10."



"Turn on captions."

Using the VIZIO Mobile app for voice control:

You can also use the free VIZIO Mobile app as a voice control remote. See **Controlling your TV with the VIZIO Mobile App on page 15** for more information.

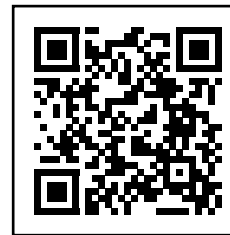

Scan with your mobile device to download the VIZIO Mobile App.

Connect to other popular voice assistant devices:

VIZIO TVs also work with Google Assistant, Siri, and Alexa-enabled devices for hands-free voice control.



TIP: If you want to use a voice assistant to turn on your TV, make sure Quick Start Mode is enabled. See the VIZIO OS User Guide for more information.

This device is equipped with the VIZIO Voice feature. By activating the VIZIO Voice feature (either through the mobile application or Bluetooth remote), you can control your Smart TV, and use many of its features, with voice commands. In order to provide you the VIZIO Voice feature, some voice commands may be transmitted to a third-party service provider that will translate your voice command into text and provide VIZIO Voice features. We may also capture and collect voice commands and associated text(s) in order to provide the VIZIO Voice feature and evaluate and improve the features. VIZIO will only capture voice commands when you press the microphone button on your remote or mobile app and speak into the microphone on the remote control or mobile phone. You may disable the VIZIO Voice feature for your remote at any time by unpairing your Bluetooth remote.

Completing the First-Time Setup

Before you begin the first-time setup:

- Your TV should be installed and the power cord should be connected to an electrical outlet.
- Have your mobile device ready for the VIZIO app download and TV registration.
- If you have a wireless network, have the network password ready.
- If you are connecting to your network with an Ethernet cable, connect one end of the cable to the Ethernet port on the TV.

The first time you turn on the TV, the on-screen instructions will guide you through each of the steps necessary to get your TV ready for use:



1. Before starting, scan the QR code with your mobile device to download the VIZIO Mobile app.

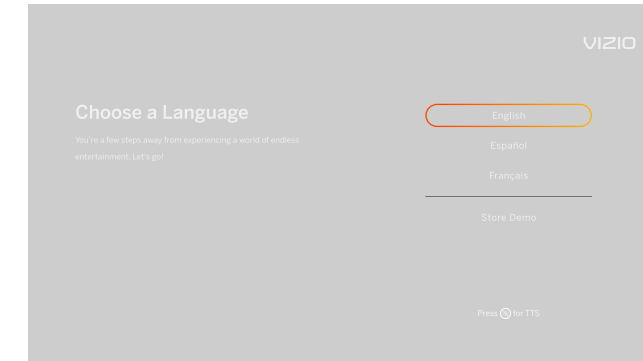

2. Choose your language. Pressing the MUTE button will enable TTS (text-to-speech) functionality.

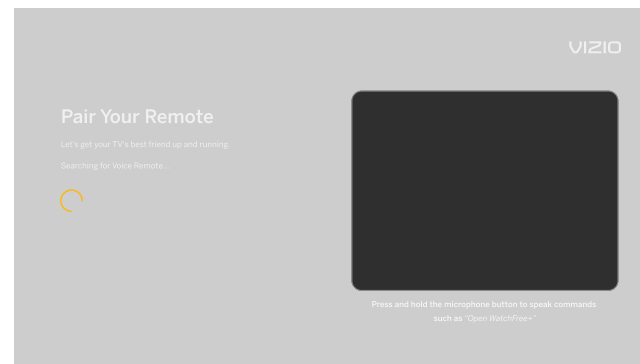

3. Pair your voice remote.

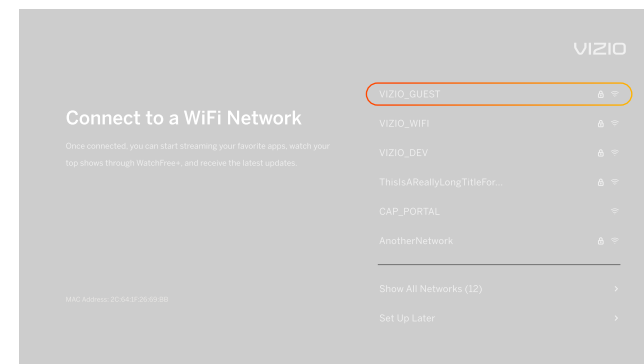

4. Choose your WiFi network and enter the password. (When connecting via Ethernet, this step is skipped)

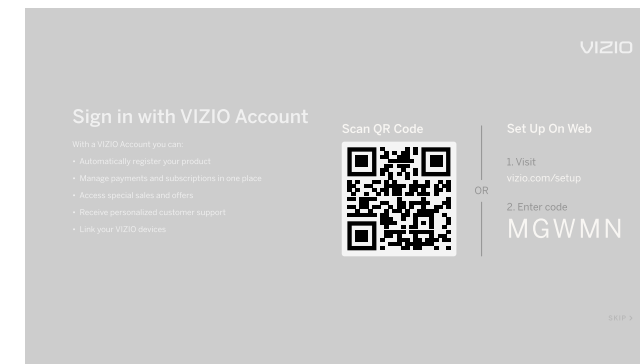

5. Scan the QR code with your mobile device to sign in and register your TV to the VIZIO Mobile App

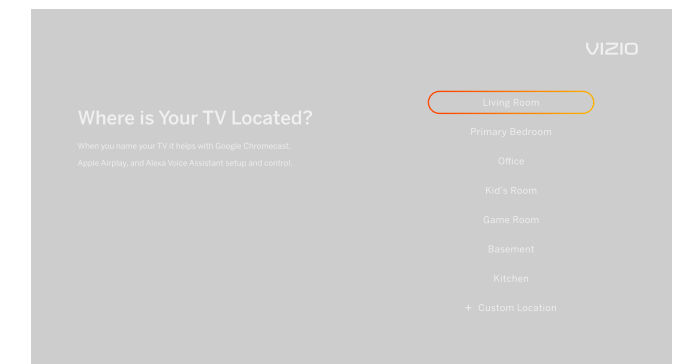

6. Name your TV

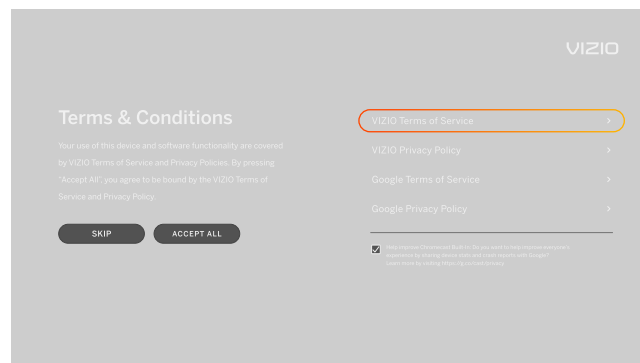

7. Accept the VIZIO Terms and Conditions

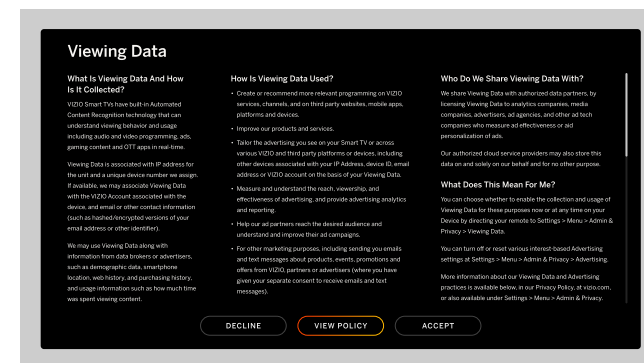

8. Accept the VIZIO Viewing Data policy.

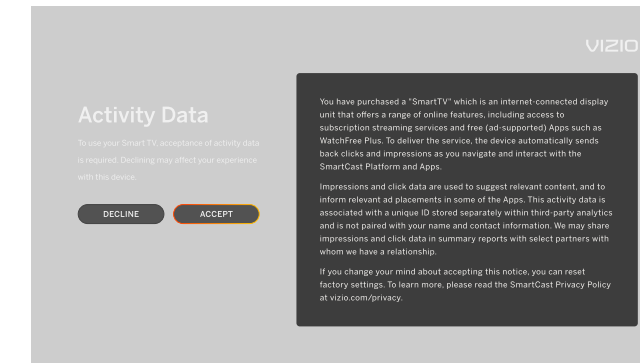

9. Accept the VIZIO Activity Data policy.



VIZIO Smart TV Platform

What is the VIZIO Smart TV Platform?

The VIZIO Smart TV Platform lets you discover, stream, and control your content like never before! Access top apps, like Netflix, Disney+, and Hulu, by using the remote to easily browse and launch content directly from the home screen. The VIZIO Smart TV home screen makes finding something to watch easy and fun.

Launching the VIZIO Smart TV Platform

To begin streaming with the VIZIO Smart TV Platform:

- Press the **Home**  button on your remote.
- or—
- Select **SmartCast** from the list of inputs.

What you can do with the VIZIO Smart TV Platform

- Stream high quality entertainment.
- Launch top tier apps directly from the home screen.
- Access free channels to watch without a subscription through WatchFree+.
- Rearrange apps on your home screen to make it just the way you like it.
- Mirror your laptop or mobile device onto your TV through Apple Airplay or Chromecast built-in.
- Use Google Assistant, Siri, and Alexa-enabled devices for hands-free voice control.



Controlling your TV with the VIZIO Mobile App

Download the VIZIO Mobile App and turn your smartphone into a remote to control and configure your TV.

With the VIZIO Mobile App, you can:

- Power on/off devices, play/pause content, and modify advanced settings, all from the palm of your hand.
- Easily enter text onto your TV/display from your mobile device using a full keyboard.
- Browse and discover movies, TV shows, music, live streams, and more, across multiple apps at once.
- Access a quick look at show ratings, synopsis, cast, crew, clips, and other details.



Scan to download.
Scan with your phone camera or QR reader.



Marquee Content
Launch content with one click
Search
Find TV shows, movies, and more

Quick Access to Popular Apps

Home Button

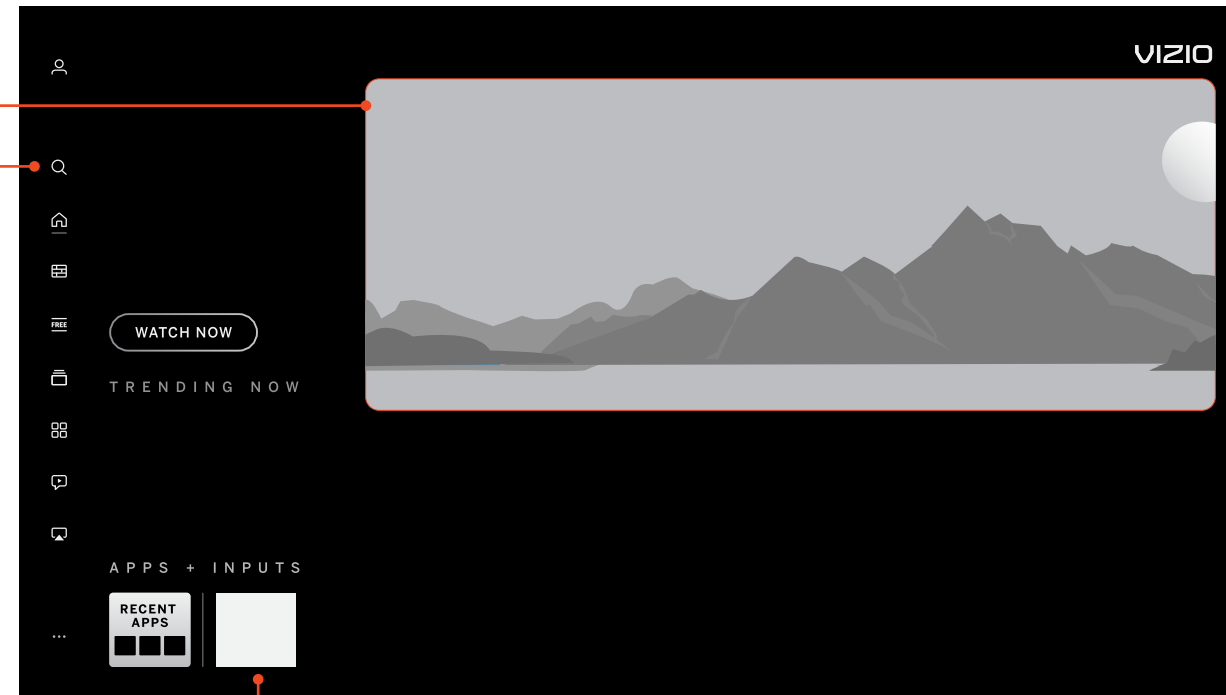
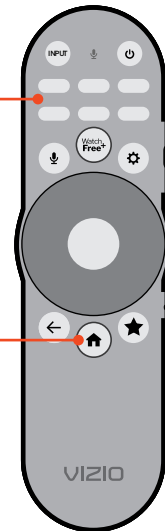

Streaming Apps on your TV

What is WatchFree+?

VIZIO WatchFree+ takes your cord-cutting entertainment experience one step further! With the simple press of a button, enjoy free streaming TV with hundreds of live TV channels to choose from – news, movies, sports, comedy, music and more. A built-in on-screen guide makes finding something to watch easier than ever.

And it's all FREE — no fees, no subscriptions, or logins.

What you can do with WatchFree+

- Stream hundreds of live TV channels absolutely free – news, movies, sports, comedy, music and more.
- Navigate through channels, organized by genre, with an intuitive on-screen guide.
- Watch the best of internet TV.
- No logins, subscriptions or transactions fees.

How to Launch WatchFree+

To launch and begin watching entertainment offered on WatchFree+:

- Press the **WatchFree+**  button on your remote.
- or—
- Select **WatchFree+** from the list of inputs or app row.

On-Screen Guide
Hundreds of live TV and audio channels organized by genre.

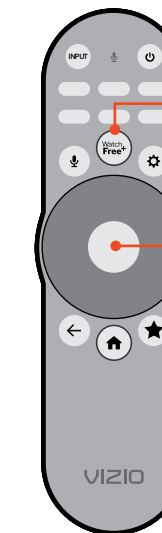
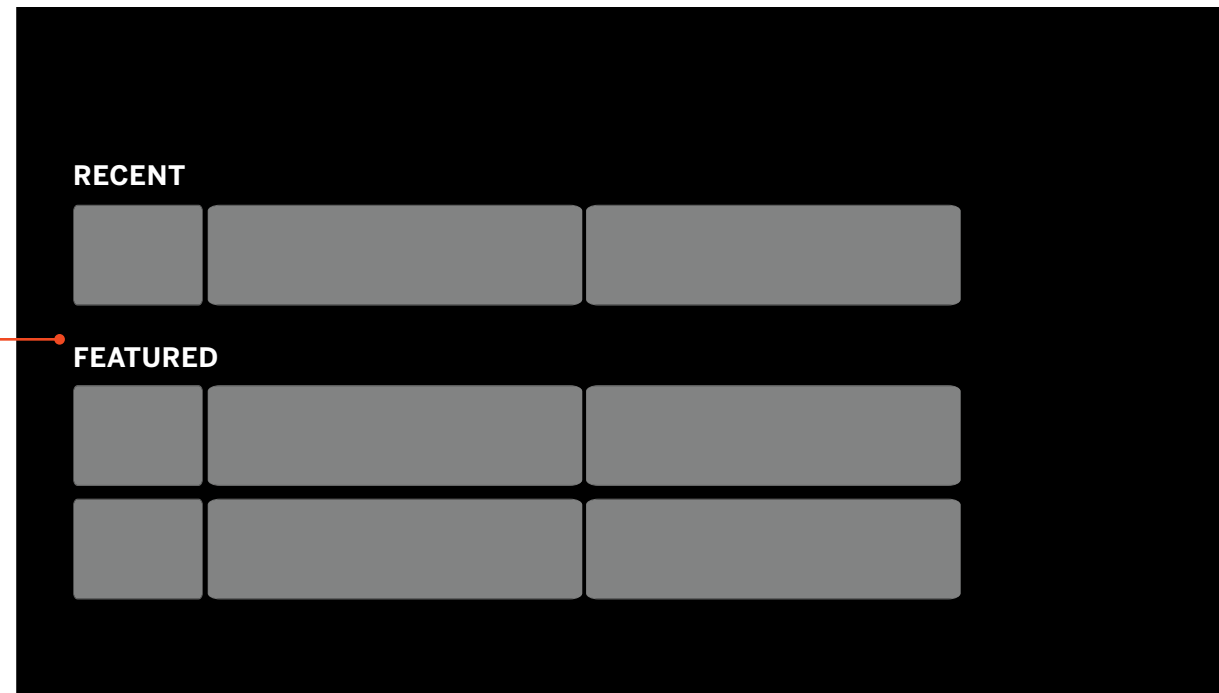

WatchFree+ Button

OK Button

Press the OK button to return to the full WatchFree+ on-screen guide. Use the up/down Navigation buttons to scroll through the guide.

Get helpful tips and register your TV.

Scan with your phone camera or QR reader.



Customized Support

Get live assistance quickly with your information on hand.



News and Offers

Take advantage of the latest news and special offers from VIZIO.



Updates and Enhancements

Stay up-to-date with important product updates and notifications.

More questions? Find answers at:
SUPPORT.VIZIO.COM

The remote is not responding.

- Make sure the batteries are properly inserted matching the - and + symbols.
- Replace the batteries with fresh ones.

The TV displays “No Signal.”

- Look behind your TV to see where your device is connected. There will be a name next to the port you are using.
 - Make sure your device is powered on.
 - Press the INPUT button on the TV remote control and choose the port your device is connected to.
- If you are using cable TV or antenna connected directly to the TV, scan for channels. See the VIZIO OS User Manual for more information.

There is no power..

- Ensure the power cable is securely attached to the TV and outlet. (Some models do not have a detachable power cable).
- Ensure the outlet the TV is connected to is working. You may want to connect another device to the outlet to ensure the devices are receiving power.
- Press the **Power/Standby** button on the remote or on the bottom of the TV to turn the TV on.

The power is on, but there is no image on the screen.

- Ensure all devices are connected securely and correctly. See your device's user manual for details.
- Ensure your TV is powering on. When your TV powers on, a light on the remote sensor will turn on. See **Front Panel on page 7**.
- Press the MENU key on your remote control. If you can see the menu, try to adjust Brightness, Contrast, or Backlight. See the VIZIO OS User Manual for more information.
- Press the INPUT button on the remote to select a different input source.

The sound is flat or dialog is not audible.

- Turn off Volume Leveling. See the VIZIO OS User Manual for more information.

Where do I find information on the accessibility features of this product and other VIZIO products?

- Please visit vizio.com/accessibility,
- Email us at: Accessibility@vizio.com, or
- Give us a call at 1-877-698-4746.

How do I stream apps like Netflix to my VIZIO TV?

- Popular apps are located on the Home screen, so you can simply navigate to the app row on your TV to start streaming.
- You can also use Apple AirPlay 2 or Chromecast built-in to stream content from your device directly to your TV. For more information, **please visit:**
 - VIZIO.com/Apple
 - VIZIO.com/Google

The colors on the TV don't look right.

- Adjust the Color and Tint settings in the Picture menu. See the VIZIO OS User Manual for more information.
- Select a pre-set picture mode. VIZIO recommends selecting Calibrated.
- Check all cables to ensure they are securely attached.

The image quality is not good.

- Image quality can vary depending on personal preference and environmental factors like how much light is in a room. Your TV includes a variety of picture settings and preset picture modes that can be adjusted to calibrate this TV to your preference. See the VIZIO OS User Manual for more information.

- Image quality can vary depending on what program you are watching, and what device or app you are using to watch it. For the best picture quality, VIZIO recommends watching HD or UHD content. You can contact your device manufacturer or app provider for more information about their video playback quality.
- For the best image quality, view high-definition programs using digital sources. Connect your devices with HDMI cables.
- If you are using an antenna, the signal strength of the channel may be low. Ensure your antenna is connected securely to the TV and move the antenna around the room or close to a window for the best signal.

The picture is distorted.

- Move the TV away from electrical appliances, cars, and fluorescent lights.
- Ensure all cables are securely attached.

The TV image does not cover the entire screen.

- If you are using TV, AV, or Component with 480i input, go to **Menu > Picture > Picture Aspect** to adjust the Aspect Ratio.

The TV has pixels (dots) that are always dark.

- Your HD TV is precision-manufactured using an extremely high level of technology. However, sometimes pixels may not display correctly. These types of occurrences are inherent to this type of product and do not constitute a defective product.

The buttons on the remote aren't working.

- Ensure you are only pressing one button at a time.
- Point the remote directly at the TV when pressing a button.
- Replace the remote batteries with new ones. See **Replacing the Batteries on page 12**.
- Remove any obstacles that may be blocking the remote sensor on the TV.

There is no sound.

- Press Volume Up on the remote control.
- Press the **MUTE** button on the remote to ensure mute is off.
- Check the audio settings to ensure your TV speakers are set to On. See the VIZIO OS User Manual for more information.
- Check the audio connections of external devices (Blu-ray player, game console, cable/satellite box) that are connected to the TV.
- If you are using an antenna, the signal strength of the channel may be low. Ensure your antenna is connected securely to the TV and move the antenna around the room or close to a window for the best signal.
- Set eARC to Off and use ARC mode.

How do I download the VIZIO Mobile App?

- Make sure your phone or tablet is connected to a WiFi network. Open a browser on your phone or tablet.
- Navigate to vizio.com/smartcastapp and follow the on-screen instructions to download the VIZIO Mobile App.

How do I change the Inputs?

- Press the INPUT button on the back of the TV to cycle through the Inputs.
- Press the INPUT button on the basic remote to cycle through the Inputs.
- Make sure the VIZIO Mobile app is installed on your phone or tablet. Open the VIZIO Mobile app. Tap on the Device list and select your TV. Tap on the Input key and select the Input of your choice.

How do I connect to my WiFi network?

- On your TV remote, press the MENU button then go to Network > Select your WiFi name > Enter password.

How do I exit Demo Mode?

- Press and hold the INPUT button on the back of the TV to exit the demo mode.

How do I watch Cable/Antenna TV channels?

- If you subscribe to cable or satellite, simply connect an HDMI cable (not included) to the receiver.
- If you use external antennas to watch local broadcast channels, use a coaxial cable to connect.

Some of my Channels are missing.

- Press the MENU button on your TV remote and select the channels option. Then select Find Channels.
- Open the VIZIO Mobile app on your phone or tablet.
- Click on: Menu Tab > SmartCast Devices > Your TV/Device Name > Channels > Find Channels.

How do I disable/enable Viewing Data?

- Press the MENU button on your remote and select ADMIN & PRIVACY. Then select Viewing Data to turn the feature on or off.

The television will not turn on using Alexa or Google Assistant.

- Ensure the television is in Quick Start Mode.
- Tap on Menu > System > Power Mode > Quick Start.

How do I know I am getting 4K resolution or HDR content such as Dolby Vision?

- As you are watching content on the television, press the INFO button on the remote or VIZIO Mobile app. You will see the current resolution being displayed along with the version of video.
- HDR will show as a Dolby Vision icon, HDR10 or HLG.

Specifications

	VQP65C-84	VQP75C-84
Size	65"	75"
Viewable Area	64.5"	74.5"
PRODUCT DIMENSIONS		
Dimensions w/ Stand	56.92" x 35.46" x 12.66" 1445.8 x 900.8 x 321.5 mm	65.70" x 40.52" x 13.44" 1668.9 x 1029.1 x 341.5 mm
Dimensions w/o Stand	56.92" x 32.67" x 2.94" 1445.8 x 829.8 x 74.8 mm	65.70" x 37.6" x 2.9" 1668.9 x 955.1 x 73.6 mm
Weight w/ Stand	39.68 lb (18 kg)	59.81 lb (27.13 kg)
Weight w/o Stand	41.01 lb (18.6 kg)	58.25 lb (26.42 kg)
Mounting Screw Size	M8 x 15 mm	M8 x 15 mm
Hole Pattern	400 mm x 300 mm	400 mm x 300 mm
# of Screws <i>(not included)</i>	4	4
PICTURE QUALITY		
Maximum Resolution	3840x2160 (UHD)	3840x2160 (UHD)
LCD Backlight	Full Array with up to 40 Local Dimming Zones	Full Array with up to 80 Local Dimming Zones
Dynamic Motion Rate	DMR240 / Clear Action 720	DMR240 / Clear Action 720
VRR	4K @ 48-120Hz, 1080p @ 48-240Hz AMD FreeSync Premium Pro	4K @ 48-120Hz, 1080p @ 48-240Hz AMD FreeSync Premium Pro
INPUTS / OUTPUTS		
HDMI Inputs	4	4
Ethernet Input	1	1
RF Antenna Input	1	1
USB	1	1
Audio Output	HDMI, eARC, BlueTooth, Digital Optical	HDMI, eARC, BlueTooth, Digital Optical
OTHER		
WiFi	Tri-Band WiFi 6E (2.4GHz, 5GHz, 6Ghz)	Tri-Band WiFi 6E (2.4GHz, 5GHz, 6Ghz)
Remote Control Type	BT / IR Voice Remote	BT / IR Voice Remote
Power Consumption	300 W	300 W
Standby Power	<0.5 W	<0.5 W
Voltage	120V	120V
OSD Language	English, French, Spanish	English, French, Spanish
Certification	UL, FCC Class B, HDMI (CEC, eARC), DTS Virtual:X, DTS:X, Dolby Audio, Dolby Vision	UL, FCC Class B, HDMI (CEC, eARC), DTS Virtual:X, DTS:X, Dolby Audio, Dolby Vision

Regulatory Information

FCC Class B Radio Interference Statement

This device complies with Part 15 of the FCC Rules. Operation is subject to the following two conditions: (1) this device may not cause harmful interference, and (2) this device must accept any interference received, including interference that may cause undesired operation.

NOTE: This equipment has been tested and found to comply with the limits for a Class B digital device, pursuant to Part 15 of the FCC Rules. These limits are designed to provide reasonable protection against harmful interference in a residential installation. This equipment generates, uses and can radiate radio frequency energy, and if not installed and used in accordance with the instructions, may cause harmful interference to radio communications. However, there is no guarantee that interference will not occur in a particular installation. If this equipment does cause harmful interference to radio or television reception, which can be determined by turning the equipment off and on, the user is encouraged to try to correct the interference by one or more of the following measures:

- Reorient or relocate the receiving antenna.
- Increase the separation between the equipment and receiver.
- Connect the equipment into an outlet on a circuit different from that to which the receiver is connected.
- Consult the dealer or an experienced radio/TV technician for help.

FCC Caution

Changes or modifications not expressly approved by the party responsible for compliance could void the user's authority to operate this equipment.

Notice

The changes or modifications not expressly approved by the party responsible for compliance could void the user's authority to operate the equipment.

Shielded interface cables and AC power cord, if any, must be used in order to comply with the emission limits.

The manufacturer is not responsible for any radio or TV interference caused by unauthorized modification to this equipment. It is the responsibilities of the user to correct such interference.

This transmitter must not be co-located or operating in conjunction with any other antenna or transmitter.

Operations in the 5GHz products are restricted to indoor usage only.

This equipment complies with FCC/ISED radiation exposure limits set forth for an uncontrolled environment. This equipment should be installed and operated with minimum distance 20cm between the radiator & your body.

Canada Notice for License-Exempt Radio Apparatus

This device complies with Industry Canada's license-exempt RSSs. Operation is subject to the following two conditions: (1) This device may not cause harmful interference, and (2) this device must accept any interference received, including interference that may cause undesired operation.

This device operates on a no-protection no-interference basis. Should the user seek to obtain protection from other radio services operating in the same TV bands, a radio license is required. Please consult Industry Canada's document CPC-2-1-28, Optional Licensing for Low-Power Radio Apparatus in the TV Bands, for details.

Cet appareil est conforme aux CNR exempts de licence d'Industrie Canada. Son fonctionnement est sujet aux deux conditions suivantes:

1. le dispositif ne doit pas produire de brouillage préjudiciable, et
2. ce dispositif doit accepter tout brouillage reçu, y compris un brouillage susceptible de provoquer un fonctionnement indésirable

Cet appareil fonctionne sur une base sans protection et sans interférence. Dans le cas où l'utilisateur cherche à obtenir de la protection des autres services de radio fonctionnant sur les mêmes bandes TV, aucune licence est requise. Veuillez consulter le document CPC-2-1-28 d'Industrie Canada, License optionnelle pour les appareils radio de faible puissance, pour plus de détails.

Industry Canada Class B emission compliance statement

This Class B digital apparatus complies with Canadian ICES-003. Cet appareil numérique de la classe B est conforme à la norme NMB-003 du Canada.

Limited Warranty

UNITED STATES AND CANADA

By using this VIZIO product, you accept all VIZIO Terms and Conditions, including all the Terms of Warranty, BINDING ARBITRATION AGREEMENT (for U.S. Residents Only), and Class Action Waiver. If you do not agree to the terms of this warranty, do not use the VIZIO product and, within thirty (30) days of the date of purchase, return it for a refund to the authorized retailer where you purchased it. **If you live in the U.S., you have the right to opt out of the Arbitration Agreement and Class Action Waiver within 60 calendar days of your purchase.** Please refer to the full section "Binding Arbitration Agreement; Class Action Waiver" below for more details and instructions for opt-out. Full Terms and Conditions may be viewed at [vizio.com/en/terms/terms-of-service](https://www.vizio.com/en/terms/terms-of-service).

How Long This Warranty Lasts

For non-commercial use, VIZIO warrants the product on the terms set forth below for one (1) year from the date of original purchase. For commercial use, VIZIO warrants this product on the terms set forth below for ninety (90) days from the date of original purchase.

What This Warranty Covers

VIZIO warrants the product against defects in materials and workmanship when the product is used normally in accordance with VIZIO's user guides and manuals.

Except where restricted by law, this warranty applies only to the original purchaser of a new product. The purchase must have been made from an authorized retailer in the United States (including Puerto Rico) or Canada. The product must also be located in the country where it was purchased at the time of warranty service.

Zero Bright Pixel Defect Guarantee (Displays Only)

Your product may qualify for a warranty against "zero bright pixel" defects for the duration of the warranty on select new product purchases. To determine if this guarantee applies to your product, refer to the model's product information page at www.vizio.com, look for the "zero bright pixel" guarantee on the box, or contact VIZIO Technical Support at the email address or telephone number below.

How to Get Service

Before obtaining warranty service, you may visit www.vizio.com for additional help and troubleshooting. To obtain warranty service, contact VIZIO Customer Support by going to support.vizio.com and selecting **Contact Us**.

Your Obligations Before Service

You must obtain pre-authorization before sending your product to a VIZIO service center. You may be required to supply a purchase receipt (or copy) to show that the product is within the warranty period. When you return a product to a VIZIO service center, you must ship the product in its original packaging or in packaging that affords an equal degree of protection. VIZIO Technical Support will provide instructions for packing and shipping the product to the VIZIO service center. ALL USER DATA AND DOWNLOADED APPLICATIONS STORED ON A PRODUCT WILL BE DELETED IN THE COURSE OF SOME IN-HOME AND ALL SHIP-IN WARRANTY SERVICE. If this occurs, your product will be restored to its original state. You will be responsible for restoring all applicable user data and downloaded applications. Recovery and reinstallation of user data and downloaded applications is not covered under this warranty. In order to protect your personal information, VIZIO recommends that you always clear all personal information from the product before it is serviced, regardless of the servicer.

VIZIO's Responsibilities

If VIZIO determines that a product is covered by this warranty, VIZIO will (at its option) repair or replace it, or refund the purchase price to you. There will be no charge for parts or labor during the warranty period. Replacement parts may be new or recertified at VIZIO's option and sole discretion. Replacement parts and VIZIO's labor are warranted for the remaining portion of the original warranty or for ninety (90) days from warranty service, whichever is longer.

Types of Service

TVs that are 32 inches or larger will usually be serviced in-home. In-home service requires complete and easy access to the product and does not include de-installation or re-installation of the product. In-home service is subject to availability. VIZIO will provide other service options when in-home service is not available. All other VIZIO products must be sent to a VIZIO service center to obtain warranty service. VIZIO is not responsible for transportation costs to the service center, but VIZIO will cover return shipping to the customer.

What This Warranty Does Not Cover

This warranty does not cover: (a) cosmetic damage; (b) normal wear and tear; (c) improper operation; (d) improper voltage supply or power surges; (e) signal issues; (f) damage from shipping; (g) acts of God; (h) customer misuse, modifications or adjustments; (i) installation, set-up, or repairs attempted by anyone other than by a VIZIO authorized service center; (j) products with unreadable or removed serial numbers; (k) products requiring routine maintenance; or (l) products sold "AS IS", "CLEARANCE", "FACTORY RECERTIFIED", or by a non-authorized reseller.

What to Do If You Are Not Satisfied With Service

If you feel VIZIO has not met its obligations under this warranty, you may attempt to resolve the issue informally with VIZIO. If you are unable to resolve the issue informally and wish to file a formal claim against VIZIO, and if you are a resident of the United States, you must submit your claim to binding arbitration according to the procedures described below, unless an exception applies. Submitting a claim to binding arbitration means that you do not have the right to have your claim heard by a judge or jury. Instead your claim will be heard by a neutral arbitrator.

Binding Arbitration Agreement; Class Action Waiver (U.S. Residents Only) UNLESS YOU HAVE BROUGHT AN ELIGIBLE CLAIM IN SMALL CLAIMS COURT OR HAVE OPTED OUT AS DESCRIBED BELOW, ANY CONTROVERSY OR CLAIM RELATING IN ANY WAY TO YOUR VIZIO PRODUCT, INCLUDING ANY CONTROVERSY OR CLAIM ARISING OUT OF OR RELATING TO THIS WARRANTY, A BREACH OF THIS WARRANTY, OR THE VIZIO PRODUCT'S SALE, CONDITION OR PERFORMANCE, WILL BE SETTLED BY BINDING ARBITRATION ADMINISTERED BY THE AMERICAN ARBITRATION ASSOCIATION AND CONDUCTED BY A SINGLE ARBITRATOR APPOINTED BY THE AMERICAN ARBITRATION ASSOCIATION, IN ACCORDANCE WITH ITS COMMERCIAL ARBITRATION RULES AND ITS SUPPLEMENTARY PROCEDURES FOR CONSUMER-RELATED DISPUTES. You may learn more about the American Arbitration Association and its rules for arbitration by visiting www.adr.org. Since this warranty concerns a transaction in interstate or international commerce, the Federal Arbitration Act will apply.

The filing fees to begin and carry out arbitration will be shared between you and VIZIO, but in no event will your fees ever exceed the amount allowable by the American Arbitration Association, at which point VIZIO will cover all additional administrative fees and expenses. VIZIO waives its right to recover attorneys' fees in connection with any arbitration under this warranty. If you are the prevailing party in an arbitration to which the Supplementary Procedures for Consumer-Related Disputes applies, then you are entitled to recover attorneys' fees as the arbitrator may determine.

The dispute will be governed by the laws of the state or territory in which you resided at the time of your purchase (if in the United States). The place of arbitration will be Irvine, California, or your county of residence (if in the United States). The arbitrator will have no authority to award punitive or other damages not measured by the prevailing party's actual damages, except as may be required by statute. The arbitrator will not award consequential damages, and any award will be limited to monetary damages and will include no equitable relief, injunction, or direction to any party other than the direction to pay a monetary amount. Judgment on the award rendered by the arbitrator

will be binding and final, except for any right of appeal provided by the Federal Arbitration Act, and may be entered in any court having jurisdiction. Except as may be required by law, neither you nor VIZIO nor an arbitrator may disclose the existence, content, or results of any arbitration under this warranty without the prior written consent of you and VIZIO.

ANY DISPUTE, WHETHER IN ARBITRATION, IN COURT, OR OTHERWISE, WILL BE CONDUCTED SOLELY ON AN INDIVIDUAL BASIS. VIZIO AND YOU AGREE THAT NO PARTY WILL HAVE THE RIGHT OR AUTHORITY FOR ANY DISPUTE TO BE ARBITRATED AS A CLASS ACTION, A PRIVATE ATTORNEY GENERAL ACTION, OR IN ANY OTHER PROCEEDING IN WHICH EITHER PARTY ACTS OR PROPOSES TO ACT IN A REPRESENTATIVE CAPACITY. NO ARBITRATION OR PROCEEDING WILL BE JOINED, CONSOLIDATED, OR COMBINED WITH ANOTHER ARBITRATION OR PROCEEDING WITHOUT THE PRIOR WRITTEN CONSENT OF ALL PARTIES TO ANY SUCH ARBITRATION OR PROCEEDING.

Opt-Out Instructions

IF YOU DO NOT WISH TO BE BOUND BY THE BINDING ARBITRATION AGREEMENT AND CLASS ACTION WAIVER, THEN: (1) you must notify VIZIO in writing within sixty (60) days of the date that you purchased the product; (2) your written notification must be mailed to VIZIO at 39 Tesla, Irvine, CA 92618, Attn: Legal Department; and (3) your written notification must include (a) your name, (b) your address, (c) the date you purchased the product, and (d) a clear statement that you wish to opt out of the binding arbitration agreement and class action waiver.

In addition, you may pursue a claim in small claims court in your county of residence (if in the United States) or in Orange County, California. In such case the provisions of the section titled "Binding Arbitration Agreement; Class Action Waiver (U.S. Residents)" will not apply.

Exclusions and Limitations

TO THE GREATEST EXTENT PERMITTED BY APPLICABLE LAW, THERE ARE NO EXPRESS WARRANTIES OTHER THAN THOSE DESCRIBED ABOVE. ANY IMPLIED WARRANTIES, INCLUDING ANY IMPLIED WARRANTY OF MERCHANTABILITY AND FITNESS FOR A PARTICULAR PURPOSE, WILL BE LIMITED IN DURATION TO THE WARRANTY PERIOD SET FORTH ABOVE. SOME STATES AND PROVINCES DO NOT ALLOW LIMITATIONS ON HOW LONG AN IMPLIED WARRANTY LASTS, SO THE ABOVE LIMITATION MAY NOT APPLY TO YOU.

VIZIO WILL NOT BE RESPONSIBLE FOR LOSS OF USE, LOSS OF INFORMATION OR DATA, COMMERCIAL LOSS, LOST REVENUE OR LOST PROFITS, OR OTHER INDIRECT, SPECIAL, INCIDENTAL OR CONSEQUENTIAL DAMAGES, EVEN IF VIZIO HAS BEEN ADVISED OF THE POSSIBILITY OF SUCH DAMAGES, AND

EVEN IF THE REMEDY FAILS OF ITS ESSENTIAL PURPOSE. SOME STATES AND PROVINCES DO NOT ALLOW THE EXCLUSION OR LIMITATION OF INCIDENTAL OR CONSEQUENTIAL DAMAGES, SO THE ABOVE LIMITATION OR EXCLUSION MAY NOT APPLY TO YOU.

IN LIEU OF ANY OTHER REMEDY FOR ANY AND ALL LOSSES AND DAMAGES RESULTING FROM ANY CAUSE WHATSOEVER (INCLUDING VIZIO'S NEGLIGENCE, ALLEGED DAMAGE, OR DEFECTIVE GOODS, NO MATTER WHETHER SUCH DEFECTS ARE DISCOVERABLE OR LATENT), VIZIO MAY, AT ITS SOLE AND EXCLUSIVE OPTION AND IN ITS DISCRETION, REPAIR OR REPLACE YOUR PRODUCT, OR REFUND ITS PURCHASE PRICE. AS NOTED, SOME STATES AND PROVINCES DO NOT ALLOW THE EXCLUSION OR LIMITATION OF INCIDENTAL OR CONSEQUENTIAL DAMAGES, SO THE ABOVE LIMITATION OR EXCLUSION MAY NOT APPLY TO YOU.

How the Law Applies

This warranty gives you specific legal rights, and you may also have other rights, which vary from state to state and province to province. This warranty applies to the greatest extent permitted by applicable law.

General

No employee or agent of VIZIO may modify this warranty. If any term of this warranty, other than the class action waiver, is found to be unenforceable, that term will be severed from this warranty and all other terms will remain in effect. If the class action waiver is found to be unenforceable, then the entire section titled "Binding Arbitration Agreement; Class Action Waiver (U.S. Residents Only)" will not apply. This warranty applies to the maximum extent not prohibited by law.

Changes to Warranty

This warranty may change without notice, but any change will not affect your original warranty. Check www.vizio.com for the most current version.

Software Licenses

All software is provided subject to a software license agreement(s) and you agree that you will be bound by such license agreement(s) in addition to these terms. Your use of this product is subject to VIZIO's privacy policy, which may be updated from time to time, and is available to view at vizio.com/privacy.

Export Regulations

Customer acknowledges that the VIZIO products, which include technology and software, are subject to customs and export control laws in the United States ("US"). The products may also be subject to the customs and export control laws and regulations of the country in which the products are manufactured and/or received.

Internet Connectivity and App Availability

Network conditions, environmental and other factors may negatively affect connectivity and the resulting video quality, if any. The applications and content of the applications pictured herein or described in accompanying documentation may only be available in certain countries or languages, may require additional fees or subscription charges, and may be subject to future updates, modifications or discontinuation without notice. VIZIO has no control over third party applications or content and assumes no responsibility for the availability or interruption of such applications or content. Additional third party terms, conditions and restrictions apply.

© 2023 VIZIO, Inc. All Rights Reserved.

This User Manual may not be copied in whole or in part without the written permission of VIZIO, Inc. VIZIO, Inc. has made reasonable efforts to ensure the accuracy of the information provided herein. All product specifications, functionality, features, configurations, performance, design and other product information described herein are subject to change without notice. VIZIO, Inc. is not responsible for typographical, technical, or descriptive errors. To review the most updated version of this User Manual and the associated Quick Start Guide, go to vizio.com.

VIZIO, the VIZIO logo, the V logo, VIZIO SmartCast, and other terms and phrases are trademarks or registered trademarks of VIZIO, Inc.

The terms HDMI, HDMI High-Definition Multimedia Interface, HDMI Trade dress and the HDMI Logos are trademarks or registered trademarks of HDMI Licensing Administrator, Inc.

For DTS patents, see <http://patents.dts.com>. Manufactured under license from DTS, Inc or under license from DTS Licensing Limited. DTS, DTS:X, Digital Surround, Virtual:X, TruVolume, the DTS logo and the DTS:X logo are registered trademarks or trademarks of DTS, Inc. in the United States and other countries. © 2021 DTS, Inc. ALL RIGHTS RESERVED.

Dolby, Dolby Vision, Dolby Audio, and the Double-D symbol are trademarks of Dolby Laboratories Licensing Corporation. Manufactured under license from Dolby Laboratories. Confidential unpublished works. Copyright © 1992-2022 Dolby Laboratories. All rights reserved.

Google, Google Play, and Chromecast Built-in are trademarks of Google LLC.

Amazon, Alexa and all related logos are trademarks of Amazon.com, Inc. or its affiliates.

Other names of companies, products, and services used in this User Manual may be trademarks, trade names or service marks of others and VIZIO, Inc. disclaims any interest in trademarks, trade names or service marks other than its own. Mention of non-VIZIO products is for informational purposes only.

App services featured on the included IR remote may vary and may not be available in all regions.

4K or HDR availability varies by app and may be subject to subscription fees, internet service, and device capabilities.



Battery Disposal

Caution: This product may be shipped with batteries. Do not dispose of batteries in a fire or with ordinary household waste. Batteries may explode and can cause damage. Replace batteries only with the same or equivalent type of battery recommended by VIZIO. The disposal of batteries may be regulated by your state. For more information on recycling or properly disposing of your batteries, please check with your state or go to vizio.com/environment.

Product Recycling

The disposal and recycling of consumer electronic products may be regulated by your state. Always properly dispose of your VIZIO products in accordance with local laws and regulations. VIZIO supports the proper recycling of our products. For information on how to properly recycle your VIZIO products and to learn more about consumer electronics recycling laws, please go to vizio.com/environment or call (800) 374-3473.

Packaging Disposal

VIZIO encourages the recycling of the packaging used for this product. Please break-down all boxes and recycle eligible materials according to local laws and regulations. For more information please go to vizio.com/environment or call (800) 374-3473.