



Built-In Combination WALL OVEN

SAFETY INFORMATION 3

USING THE OVEN

Features 23

Oven Controls 24

Oven Settings 25

UPPER OVEN

Before Using 30

Microwave Cookware Guide 30

Microwave Mode 34

Convection Bake Mode 35

Broil Mode 35

Popcorn Mode 36

Defrost Mode 36

Speed Cook Mode 37

Sensor Cook Mode 38

Microwave Quick Start Mode 39

Precision Cook Mode 40

Soften Mode 43

Melt Mode 43

Warm Mode 44

Proof Mode 44

LOWER OVEN

Before Using 45

Oven Racks 45

Convection Bake and Roast Mode 46

Bake Mode 47

Broil Mode 48

Warm Mode 51

Proof Mode 52

Air Fry 52

Probe Mode 55

Favorite Mode 57

Precision Cook Mode 59

Steam Function 60

Sous Vide 61

CARE AND CLEANING

Upper Oven Interior 62

Cleaning the Exterior 63

Lower Oven Interior 64

 EasyClean 64

 Self Clean 67

 Oven Light 70

TROUBLESHOOTING 71

LIMITED WARRANTY 78

ACCESSORIES 79

CONSUMER SUPPORT 80

OWNER'S MANUAL

PT9900

Write the model and serial numbers here:

Model # _____

Serial # _____

You can find them on a label on the front of the upper oven behind the oven door.



THANK YOU FOR MAKING GE APPLIANCES A PART OF YOUR HOME.

Whether you grew up with GE Appliances, or this is your first, we're happy to have you in the family.

We take pride in the craftsmanship, innovation and design that goes into every GE Appliances product, and we think you will too. Among other things, registration of your appliance ensures that we can deliver important product information and warranty details when you need them.

Register your GE appliance now online. Helpful websites and phone numbers are available in the Consumer Support section of this Owner's Manual. You may also mail in the pre-printed registration card included in the packing material.



IMPORTANT SAFETY INFORMATION

READ ALL INSTRUCTIONS BEFORE USING THE APPLIANCE

▲ WARNING

To reduce the risk of burns, electric shock, fire, injury to persons, or exposure to excessive microwave energy:

When using electrical appliances, basic safety precautions should be followed, including the following:

- Read all instructions before using this appliance.
- Read and follow the specific precautions in the PRECAUTIONS TO AVOID POSSIBLE EXPOSURE TO EXCESSIVE MICROWAVE ENERGY section.
- Use this appliance only for its intended use as described in this manual. Do not use corrosive chemicals or vapors in this appliance. This oven is specifically designed to heat, dry or cook food, and is not intended for laboratory or industrial use.
- This appliance must only be serviced by qualified service personnel. Contact nearest authorized service facility for examination, repair or adjustment.

INSTALLATION

- Install or locate this appliance only in accordance with the provided installation instructions.
- Be sure your appliance is properly installed and grounded by a qualified technician in accordance with the provided installation instructions.
- This oven is UL listed for standard wall installation.
- Do not operate this appliance if it is not working properly or it has been damaged or dropped.
- Do not cover or block any openings on the appliance.
- Do not store this appliance outdoors. Do not use this product near water—for example, in a wet basement, near a swimming pool, near a sink or in similar locations.
- Do not mount this appliance over a sink.

TO REDUCE THE RISK OF FIRE IN THE CAVITY:

- Do not overcook food. Carefully attend appliance when paper, plastic or other combustible materials are placed inside the oven to facilitate cooking.
- Remove wire twist-ties and metal handles from paper or plastic containers before placing them in the oven.
- If materials inside the oven ignite, keep the oven door closed, turn the oven off and disconnect the power cord or shut off power at the fuse or circuit breaker panel.
- Do not store any materials in this oven when not in use. Do not leave paper products, cooking utensils or food in the cavity when not in use. All racks should be removed from oven when not in use.
- Do not operate the microwave feature without food in the oven.

TO REDUCE THE RISK OF BURNS:

- Be careful when opening containers of hot food. Use pot holders and direct steam away from face and hands.
- Vent, pierce, or slit containers, pouches, or plastic bags to prevent build-up of pressure.
- Be careful when touching the turntable, door, racks, or walls of the oven which may become hot during use.
- Energized interior cavity lighting will cause burns. Use caution when cleaning and allow lamps to cool prior to replacement.
- **HOT CONTENTS CAN CAUSE SEVERE BURNS, DO NOT ALLOW CHILDREN TO USE THE MICROWAVE.** Use caution when removing hot items.

READ AND SAVE THESE INSTRUCTIONS

IMPORTANT SAFETY INFORMATION

READ ALL INSTRUCTIONS BEFORE USING THE APPLIANCE

⚠ WARNING Continued

OPERATING

- Do not operate the oven without the turntable in place. The turntable must be unrestricted so it can turn.
- Oversized foods or oversized metal utensils should not be inserted in a microwave/convection oven as they may create a fire or risk of electric shock.
- Do not use paper products in oven when appliance is operating in any cooking mode except microwave.
- Make sure all cookware used in your microwave oven is suitable for microwaving. Most glass casseroles, cooking dishes, measuring cups, pottery or china dinnerware, which does not have metallic trim or glass with a metallic sheen can be used in compliance with cookware manufactures' recommendations.
- Some products such as whole eggs and sealed containers—for example, closed jars—are able to explode and should not be heated in this oven.
- Do not overcook potatoes. They could dehydrate and catch fire.
- Do not cover the turntable, wire oven rack, trays or any part of the oven with metal foil. This will cause arcing in the microwave/convection oven.
- This oven is not approved or tested for marine use.

CLEANING

- Disconnect power before cleaning.
- Disconnect power before replacing cavity lamps.
- Keep the oven free from grease buildup.

- Do not clean with metal scouring pads. Pieces can burn off the pad and touch electrical parts involving a risk of electric shock.
- When cleaning surfaces of door and oven that comes together on closing the door, use only mild, nonabrasive soaps, or detergents applied with a clean sponge or soft cloth. Rinse well.

SUPER HEATED WATER

- Liquids, such as water, coffee, or tea, are able to be overheated beyond the boiling point without appearing to be boiling. Visible bubbling or boiling when the container is removed from the microwave oven is not always present. **THIS COULD RESULT IN VERY HOT LIQUIDS SUDDENLY BOILING OVER WHEN THE CONTAINER IS DISTURBED OR A SPOON OR OTHER UTENSIL IS INSERTED INTO THE LIQUID.**
- To reduce the risk of injury to persons:
 - Do not overheat the liquid.
 - Stir the liquid both before and halfway through heating it.
 - Do not use straight-sided containers with narrow necks.
 - After heating, allow the container to stand in the microwave oven for a short time before removing the container.
 - Use extreme care when inserting a spoon or other utensil into the container.

READ AND SAVE THESE INSTRUCTIONS

IMPORTANT SAFETY INFORMATION

READ ALL INSTRUCTIONS BEFORE USING THE APPLIANCE

▲WARNING ARCING

Arcing can occur during microwave cooking and, for certain models, in fast cook and precision cook modes. If you see arcing, press the Clear/Off pad or Power Key and correct the problem.

Arcing is the microwave term for sparks in the oven. Arcing is caused by:

- Metal or foil touching the side of the oven.
- Foil not molded to food (upturned edges act like antennas).
- Use foil only as recommended in this manual.
- Metal cookware used during Precision/Speed Cook (on some models) or microwave cooking (except for pans provided with the oven).
- Metal, such as twist-ties, poultry pins, or gold-rimmed dishes, in the oven.
- Recycled paper towels containing small metal pieces being used in the oven.

▲WARNING MICROWAVE-SAFE COOKWARE

Make sure to use suitable cookware during microwave cooking. Most glass casseroles, cooking dishes, measuring cups, custard cups, pottery or china dinnerware which does not have metallic trim or glaze with a metallic sheen can be used. Some cookware is labeled "suitable for microwaving."

- Place food or microwavable container directly on the clear glass tray to cook your food.
- Use of a metal tray during microwave cooking will result in inferior cooking performance.
- Cookware may become hot because of heat transferred from the heated food. Oven mitts may be needed to handle the cookware.
- Do not use recycled paper products. Recycled paper towels, napkins and waxed paper can contain metal flecks which may cause arcing or ignite. Paper products containing nylon or nylon filaments should be avoided, as they may also ignite.
- Use foil only as directed in this manual. When using foil in the oven, keep the foil at least 1" away from the sides of the oven.
- If you use a meat thermometer while cooking, make sure it is safe for use in microwave ovens.
- Some foam trays (like those that meat is packaged on) have a thin strip of metal embedded in the bottom. When microwaved, the metal can burn the floor of the oven or ignite a paper towel.
- Paper towels, waxed paper and plastic wrap can be used to cover dishes in order to retain moisture and prevent spattering. Be sure to vent plastic wrap so steam can escape.
- Not all plastic wrap is suitable for use in microwave ovens. Check the package for proper use.

READ AND SAVE THESE INSTRUCTIONS

IMPORTANT SAFETY INFORMATION

READ ALL INSTRUCTIONS BEFORE USING THE APPLIANCE

⚠ WARNING MICROWAVE-SAFE COOKWARE (Cont.)

- “Boilable” cooking pouches and tightly closed plastic bags should be slit, pierced or vented as directed by package instructions. If they are not, plastic could burst during or immediately after cooking, possibly resulting in injury. Also, plastic storage containers should be at least partially uncovered because they form a tight seal. When cooking with containers tightly covered with plastic wrap, remove covering carefully and direct steam away from hands and face.
 - Plastic cookware—Plastic cookware designed for microwave cooking is very useful, but should be used carefully. Even microwave-safe plastic may not be as tolerant of overcooking conditions as are glass or ceramic materials. Plastic may soften or char if subjected to short periods of overcooking. In longer exposures to overcooking, the food and cookware could ignite.
 - Do not use the wire oven rack for microwaving.
- Follow these guidelines:
1. Use microwave-safe plastics only, and use them in strict compliance with the cookware manufacturer’s recommendations.
 2. Do not microwave empty containers.



The **turntable** must always be in place when using the oven.



The **clear glass tray** should always be in place when **microwaving**.

⚠ WARNING (On Some Models) OVEN-SAFE COOKWARE FOR PRECISION/SPEED COOK

- The oven and door will get very hot when Precision/Speed Cooking.
- Cookware will become hot. Oven mitts will be needed to handle the cookware.
- Do not use coverings, containers or cooking/roasting bags made of foil, plastic, wax or paper when Precision/Speed Cooking.
- Do not cover the turntable, wire oven rack, trays or any part of the oven with metal foil. This will cause arcing in the microwave/convection oven.
- Use the metal tray in the same way you would use a shallow baking pan or baking tray.
- Place food directly on the metal trays when cooking unless prompted by the oven to do otherwise.
- Any non-metal oven-safe dish can be used in your oven. Recipes in the Advantium Cookbook were tested in Pyrex® glass cookware and Corningware® ceramic casseroles. Cook times and results may vary when using other types of oven-safe dishes. Place them directly on the trays.
- Use of the clear glass tray when Precision/Speed Cooking will result in inferior cooking performance and possible cracking of the glass tray.
- Use only the metal trays specified for use with this oven. Other metal trays are not designed for use with this oven and will result in inferior cooking performance.



The **turntable** must always be in place when using the oven.



Put food directly on the metal tray to convection bake, warm or toast.

READ AND SAVE THESE INSTRUCTIONS

IMPORTANT SAFETY INFORMATION

READ ALL INSTRUCTIONS BEFORE USING THE APPLIANCE

▲WARNING (On Some Models) OVEN-SAFE COOKWARE FOR BAKING, BROILING, WARMING, PROOFING & TOASTING

- The oven and door will get very hot when convection baking, broiling, warming or toasting.
- Cookware will become hot. Oven mitts will be needed to handle the cookware.
- Do not use coverings, containers or cooking/roasting bags made of foil, plastic, wax or paper when broiling or toasting.
- Do not cover the turntable, wire oven rack, trays or any part of the oven with metal foil. This will cause arcing in the microwave/convection oven.
- Use the metal tray in the same way you would use a shallow baking pan or baking tray.
- Use the wire oven rack when convection baking or warming on two levels.
- Place food directly on the metal trays when cooking unless the recipe requires a dish.
- Any oven-safe dish can be used in your oven. Recipes in the Advantium Cookbook were tested in Pyrex® glass cookware and Corningware® ceramic casseroles. Cook times and results may vary when using other types of oven-safe dishes. Place them directly on the trays.
- Use of the clear glass tray when convection baking, broiling, warming or toasting will result in inferior cooking performance.



The turntable must always be in place when using the oven.



Put food directly on the metal tray to convection bake, warm or toast.

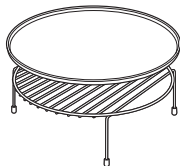

Put food directly on the aluminum baking sheet on the wire oven rack, and place them on the non-stick metal tray, when baking on two levels, broiling or toasting foods.

PRECAUTIONS TO AVOID POSSIBLE EXPOSURE TO EXCESSIVE MICROWAVE ENERGY

- (a) **Do Not Attempt** to operate this oven with the door open since open-door operation can result in harmful exposure to microwave energy. It is important not to defeat or tamper with the safety interlocks.
- (b) **Do Not Place** any object between the oven front face and the door or allow soil or cleaner residue to accumulate on sealing surfaces.
- (c) **Do Not Operate** the oven if it is damaged. It is particularly important that the oven door close properly and that there is no damage to the:
 - (1) door (bent),
 - (2) hinges and latches (broken or loosened),
 - (3) door seals and sealing surfaces.
- (d) **The Oven Should Not** be adjusted or repaired by anyone except properly qualified service personnel.

READ AND SAVE THESE INSTRUCTIONS

**IMPORTANT SAFETY INFORMATION
READ ALL INSTRUCTIONS BEFORE USING THE APPLIANCE**

⚠ WARNING NOTICE—PACEMAKERS

Most pacemakers are shielded from interference from electronic products, including microwaves. However, patients with pacemakers may wish to consult their physicians if they have concerns.

READ AND SAVE THESE INSTRUCTIONS

IMPORTANT SAFETY INFORMATION

READ ALL INSTRUCTIONS BEFORE USING THE APPLIANCE

▲ WARNING Read all safety instructions before using the product. Failure to follow these instructions may result in fire, electrical shock, serious injury or death.

▲ WARNING GENERAL SAFETY INSTRUCTIONS

- Use this appliance only for its intended purpose as described in the Owner's Manual.
 - Have your appliance installed and properly grounded by a qualified installer in accordance with the provided installation instructions.
 - Any adjustment, repair or service not specifically recommended in the Owner's Manual should be performed **ONLY** by a qualified appliance installer or service technician.
 - Before performing any service, unplug the appliance or disconnect the power supply at the household distribution panel by removing the fuse or switching off the circuit breaker.
 - Be sure all packing materials are removed from the appliance before operating to prevent ignition of these materials.
 - Avoid scratching or impacting glass doors, cooktops, or control panels. Doing so may lead to glass breakage.
 - Do not cook on a product with broken glass. Shock, fire, or cuts may occur.
 - Do not leave children alone or unattended in an area where an appliance is in use. They should never be allowed to climb, sit or stand on any part of the appliance.
- ▲ CAUTION** Do not store items of interest to children in cabinets above or on top of the appliance - children climbing on the oven to reach items could be seriously injured.
- Never use your appliance for warming or heating the room.
 - Do not allow anyone to climb, stand or hang on the oven door, drawer, or cooktop. They could damage the appliance or tip it over causing severe injury or death.
- Use only dry pot holders—moist or damp pot holders on hot surfaces may result in burns from steam. Do not let pot holders touch surface units or oven heating elements. Do not use a towel or other bulky cloth in place of pot holders.
 - Do not touch the burners, griddles (on some models), grates (on some models), the cooktop or oven heating elements, or the interior surface of the oven. These surfaces may remain hot enough to burn for an extended period of time following cooking, even though they no longer appear to be on or hot.
 - During and after use, do not touch, or let clothing or other flammable materials contact any interior area of the oven; allow sufficient time for cooling first. Other surfaces of the appliance may become hot enough to cause burns. Potentially hot surfaces include burners or heating elements, grates (on some models), cooktop surface, oven vent openings, surfaces near the openings, crevices around the oven door, metal trim parts above the door, any backguard, or shelves located above cooking surface.
 - Do not heat unopened food containers. Pressure could build up and the container could burst, causing an injury.
 - Cook food thoroughly to help protect against foodborne illness. Minimum safe food temperature recommendations are provided by the USDA and FDA. Use a food thermometer to take food temperatures and check several locations.
 - Keep the ventilator hood and grease filters clean to maintain good venting and to avoid grease fires. Turn the ventilator **OFF** in case of a fire. The blower if in operation, could spread the flames.

READ AND SAVE THESE INSTRUCTIONS

IMPORTANT SAFETY INFORMATION

READ ALL INSTRUCTIONS BEFORE USING THE APPLIANCE

▲ WARNING KEEP FLAMMABLE MATERIALS AWAY FROM THE RANGE Failure to do so may result in fire or personal injury.

- Do not store or use flammable materials in an oven or near the cooktop, including paper, plastic, pot holders, linens, wall coverings, curtains, drapes and gasoline or other flammable vapors and liquids.
- Never wear loose-fitting or hanging garments while using the appliance. These garments may ignite if they contact hot surfaces causing severe burns.
- Do not let cooking grease or other flammable materials accumulate in or near the appliance. Grease in the oven or on the cooktop may ignite.
- Do not store any flammable materials or temperature sensitive items inside of or on the appliance.
- Clean ventilating hoods frequently. Grease should not be allowed to accumulate on the hood or filter.
- (On some models) **Remote Operation** – This appliance is configurable to allow remote operation at any time.

▲ WARNING IN THE EVENT OF A FIRE, TAKE THE FOLLOWING STEPS TO PREVENT INJURY AND FIRE SPREADING

- Do not use water on grease fires. Never pick up a flaming pan. Turn the controls off. Smother a flaming pan on a surface unit by covering the pan completely with a well-fitting lid, cookie sheet or flat tray. Use a multi-purpose dry chemical or foam-type fire extinguisher.
- If there is a fire in the oven during baking, smother the fire by closing the oven door and turning the oven off or by using a multi-purpose dry chemical or foam-type fire extinguisher.
- If there is a fire in the oven during self-clean, turn the oven off and wait for the fire to go out. Do not force the door open. Introduction of fresh air at self-clean temperatures may lead to a burst of flame from the oven. Failure to follow this instruction may result in severe burns.

▲ WARNING OVEN SAFETY INSTRUCTIONS

- Stand away from the appliance when opening the oven door. Hot air or steam which escapes can cause burns to hands, face and/or eyes.
- Do not use the oven if a heating element develops a glowing spot during use or shows other signs of damage. A glowing spot indicates the heating element may fail and present a potential burn, fire, or shock hazard. Turn the oven off immediately and have the heating element replaced by a qualified service technician.
- Keep the oven vent unobstructed.
- Never place cooking utensils, pizza or baking stones, or any type of foil or liner on the oven floor. These items can trap heat or melt, resulting in damage to the product and risk of shock, smoke or fire.

READ AND SAVE THESE INSTRUCTIONS

IMPORTANT SAFETY INFORMATION

READ ALL INSTRUCTIONS BEFORE USING THE APPLIANCE

▲WARNING OVEN SAFETY INSTRUCTIONS (Cont.)

- Place oven racks in desired location while oven is cool. If rack must be moved while oven is hot, be careful to avoid touching hot surfaces and do not let pot holder contact hot heating element in oven.
- Do not leave items such as paper, cooking utensils or food in the oven when not in use. Items stored in an oven can ignite.
- Do not leave items on the cooktop near the oven vent. Items may overheat resulting in a risk of fire or burns.
- Never broil with the door open.
- Keep the oven free from grease buildup. Grease in the oven may ignite.
- When using cooking or roasting bags in the oven, follow the manufacturer's directions.
- **SHOCK OR BURN HAZARD:** Before replacing oven light bulb, disconnect the electrical power to the appliance at the main fuse or circuit breaker panel. Failure to do so may result in electric shock or burn.
- **▲CAUTION** **BURN HAZARD:** The glass cover and bulb should be removed when cool. Touching hot glass with bare hands or a damp cloth can cause burns.
- Do not use any type of foil or liner to cover the oven bottom or anywhere in the oven, except as described in the Owner's Manual. Oven liners can trap heat or melt, resulting in damage to the product and risk of shock, smoke or fire.

▲WARNING SELF-CLEANING OVEN SAFETY INSTRUCTIONS (On some models)

The self-cleaning feature operates the oven at temperatures high enough to burn away food soils in the oven. Follow these instructions for safe operation.

- Do not touch oven surfaces during self-clean operation. Keep children away from the appliance during self-cleaning. Failure to follow these instructions may cause burns.
- Before operating the self-clean cycle, remove pans, shiny metal oven racks, and other utensils from the oven. Only dark-colored porcelain-coated oven racks may be left in the oven. Failure to do so may cause damage to these items and the oven and present a potential burn or fire hazard.
- Before operating the self-clean cycle, wipe grease and food soils from the oven. Excessive amount of grease may ignite leading to smoke damage to your home.
- If the self-cleaning mode malfunctions, turn the oven off and disconnect the power supply. Have it serviced by a qualified technician.
- Do not use oven cleaners. No commercial oven cleaner or oven liner protective coating of any kind should be used in or around any part of the oven unless certified for use in a self-cleaning oven.
- Do not clean the door gasket. The door gasket is essential for a good seal. Care should be taken not to rub, damage or move the gasket.
- **IMPORTANT:** The health of some birds is extremely sensitive to the fumes given off during the self-cleaning cycle of any appliance. Move birds to another well-ventilated room.

READ AND SAVE THESE INSTRUCTIONS

IMPORTANT SAFETY INFORMATION

READ ALL INSTRUCTIONS BEFORE USING THE APPLIANCE

⚠ WARNING REMOTE ENABLE EQUIPMENT (On some models)

This device complies with part 15 of the FCC Rules. Operation is subject to the following two conditions:

(1) This device may not cause harmful interference, and (2) this device must accept any interference received, including interference that may cause undesired operation. The wireless communication equipment installed on this range has been tested and found to comply with the limits for a Class B digital device, pursuant to part 15 of the FCC Rules.

These limits are designed to:

(a) provide reasonable protection against harmful interference in a residential installation. This equipment generates, uses and can radiate radio frequency energy and, if not installed and used in accordance with the instructions, may cause harmful interference to radio communications. However, there is no guarantee that interference will not occur in a particular installation.

If this equipment does cause harmful interference to radio or television reception, which can be determined by turning the equipment off and on, the user is encouraged to try to correct the interference by one or more of the following measures:

- Reorient or relocate the receiving antenna.
- Increase the separation between the equipment and receiver.
- Connect the equipment into an outlet on a circuit different from that to which the receiver is connected.
- Consult the dealer or an experienced radio/TV technician for help.

(b) accept any interference received, including interference that may cause undesired operation of the device. Note that any changes or modifications to the wireless communication device installed on this appliance that are not expressly approved by the manufacturer could void the user's authority to operate the equipment.

PROPER DISPOSAL OF YOUR APPLIANCE

Dispose of or recycle your appliance in accordance with Federal and Local Regulations. Contact your local authorities for the environmentally safe disposal or recycling of your appliance.

How to Remove Protective Shipping Film and Packaging Tape

Carefully grasp a corner of the protective shipping film with your fingers and slowly peel it from the appliance surface. Do not use any sharp items to remove the film. Remove all of the film before using the appliance for the first time.

To assure no damage is done to the finish of the product, the safest way to remove the adhesive from packaging tape on new

appliances is an application of a household liquid dishwashing detergent. Apply with a soft cloth and allow to soak.

NOTE: The adhesive must be removed from all parts. It cannot be removed if it is baked on.

Consider recycling options for your appliance packaging material.

READ AND SAVE THESE INSTRUCTIONS

INFORMACIÓN IMPORTANTE DE SEGURIDAD

LEA TODAS LAS INSTRUCCIONES ANTES DE USAR ESTE ELECTRODOMÉSTICO

⚠️ ADVERTENCIA

Para reducir el riesgo de quemaduras, descargas eléctricas, incendio, lesiones o exposición a energía de microondas excesiva:

Cuando utilice aparatos eléctricos, se deben seguir las precauciones de seguridad básicas, entre las que se incluyen las siguientes:

- Lea todas las instrucciones antes de utilizar este aparato.
- Lea y siga las precauciones específicas descritas en la sección PRECAUCIONES PARA EVITAR LA POSIBLE EXPOSICIÓN A ENERGÍA DE MICROONDAS EXCESIVA de la página 8.
- Utilice este aparato solamente para el fin previsto, como se describe en este manual. No utilice químicos ni vapores corrosivos en este aparato. Este horno está específicamente diseñado para calentar, secar o cocinar alimentos y bebidas y no está diseñado para usarse en un laboratorio ni para uso industrial.
- Sólo personal cualificado debe reparar este aparato. Póngase en contacto con el centro de mantenimiento autorizado más cercano en caso de necesitar revisión, reparación o ajuste.

INSTALLATION

- Instale o ubique este aparato únicamente de acuerdo a las instrucciones de instalación suministradas.
- Asegúrese que su aparato esté instalado y puesto a tierra apropiadamente por un técnico cualificado de acuerdo a las instrucciones de instalación suministradas.
- Este horno está listado por UL para la instalación de pared estándar.
- No utilice este electrodoméstico si el mismo no funciona de forma correcta o si sufrió daños o caídas.
- No cubra ni bloquee ninguna apertura de este aparato.
- No almacene este aparato al aire libre. No utilice este producto cerca del agua; por ejemplo, en un sótano húmedo, cerca de una piscina, cerca de un lavabo o lugares similares.
- No monte este aparato sobre el fregadero.

PARA REDUCIR EL RIESGO DE INCENDIO DENTRO DEL HORNO:

- No cocine excesivamente los alimentos. Vigile cuidadosamente el aparato cuando coloque papel, plástico u otros materiales combustibles dentro del microondas para facilitar la cocción.
- Quite las tiritas de seguridad (twist-ties) y asas metálicas de los recipientes de papel o plástico antes de colocarlos dentro del microondas.
- Si los materiales que se encuentran dentro del horno prenden fuego, mantenga cerrada la puerta del horno, apáguelo y desconecte el cable eléctrico, o corte la energía desde el panel de fusibles o del interruptor de circuitos.
- No utilice el horno para almacenar elementos. No deje productos de papel, utensilios de cocina o alimentos en el horno cuando no lo esté usando. Todos los estantes deberán ser retirados del horno cuando no se encuentren en uso.
- No opere el horno sin alimentos adentro.

A FIN DE REDUCIR RIESGOS DE QUEMADURAS:

- Tenga cuidado al abrir envases con comida caliente. Use manijas y aleje el vapor del rostro y las manos.
- Ventile, perfore, o corte envases, bolsas, o bolsas plásticas para evitar la acumulación de presión.
- Tenga cuidado al tocar el plato giratorio, la puerta, estantes o paredes del horno, los cuales se podrán calentar durante el uso.
- La luz de la cavidad interior encendida ocasionará quemaduras. Tenga cuidado al limpiar y espere hasta que las bombillas se enfríen antes de su reemplazo.
- LOS CONTENIDOS CALIENTES PODRÁN OCASIONAR QUEMADURAS GRAVES; NO PERMITA QUE LOS NIÑOS USEN EL HORNO MICROONDAS. Tenga cuidado al retirar artículos calientes.

LEA Y GUARDE ESTAS INSTRUCCIONES

INFORMACIÓN IMPORTANTE DE SEGURIDAD

LEA TODAS LAS INSTRUCCIONES ANTES DE USAR ESTE ELECTRODOMÉSTICO

▲ ADVERTENCIA Continuo

USO

- No haga funcionar el microondas sin tener colocada en su lugar la base giratoria. La base giratoria debe estar libre de bloqueos para poder girar.
- Las comidas o utensilios metálicos de tamaño excesivo no deberán ser insertados en un horno microondas/ convección, ya que podrán generar un incendio o riesgos de descargas eléctricas.
- No utilice productos de papel cuando el aparato se utiliza en modos diferentes al microondas.
- Asegúrese de que todos los utensilios usados en el horno microondas sean para uso en el mismo. Se podrá usar la mayoría de las cacerolas de vidrio, platos de cocción, tazas graduadas, vajillas de cerámica o porcelana que no posean bordes metálicos o vidrios con un brillo metálico, en cumplimiento con las recomendaciones del fabricante de utensilios.
- Algunos productos tales como huevos enteros y contenedores sellados (por ejemplo, frascos sellados) son propensos a explotar y no deben calentarse en este horno. Tal uso del horno puede resultar en lesiones personales.
- No cocine las papas excesivamente. Pueden deshidratarse y provocar fuego.
- No cubra la base giratoria, parrilla de alambre, bandejas ni ninguna pieza del horno con láminas de metal. Esto causará arqueo voltaico en el microwave/convection oven.
- Este horno no ha sido aprobado ni probado para utilización marina.

LIMPIEZA

- Desconecte la corriente antes de realizar la limpieza.
- Desconecte la corriente antes de reemplazar los bombillos de la cavidad.
- Mantenga el horno libre de acumulación de grasa.
- No limpie con esponjillas de metal. Pueden desprenderse pedazos de la esponjilla y tocar partes eléctricas, provocando un riesgo de descarga eléctrica.
- Al limpiar superficies de puertas y horno que se unen al cerrar la puerta, sólo use detergentes suaves no abrasivos aplicados con una esponja limpia o un paño suave. Enjuague bien.

AGUA SOBRECALENTADA

- Líquidos, tales como agua, café o té, son capaces de sobrecalentarse más allá del punto de ebullición sin parecer que estén hirviendo. No siempre hay burbujeo o hervor visible cuando se saca el recipiente del horno microondas. **ESTO PUEDE RESULTAR EN LA EBULLICIÓN REPENTINA DE LÍQUIDOS MUY CALIENTES CUANDO SE MUEVE EL RECIPIENTE O SE INSERTA UNA CUCHARA U OTRO UTENSILIO DENTRO DEL LÍQUIDO.**
- Para reducir el riesgo de lesión física:
 - No sobrecaliente el líquido.
 - Revuelva el líquido antes y a la mitad del tiempo de calentamiento.
 - No utilice recipientes con costados rectos y cuellos angostos.
 - Después de calentar el recipiente, déjelo en el horno microondas por un período corto de tiempo antes de sacarlo.
 - Tenga extrema precaución cuando introduzca una cuchara u otro utensilio en el recipiente.

LEA Y GUARDE ESTAS INSTRUCCIONES

INFORMACIÓN IMPORTANTE DE SEGURIDAD

LEA TODAS LAS INSTRUCCIONES ANTES DE USAR ESTE ELECTRODOMÉSTICO

▲ ADVERTENCIA ARQUEO VOLTAICO

Se pueden producir arcos voltaicos al cocinar con microondas y, en ciertos modelos, en los modos de cocción rápida y cocción con precisión. Si nota que ocurre arco voltaico, apriete el botón táctil **Clear/Off (Borrar/ Apagar)** y corrija el problema.

El arco voltaico es el término técnico que define las chispas en el horno. El arco voltaico es causado por:

- Metal o lámina de metal en contacto con el costado del horno.
- Lámina no moldeada al alimento (los bordes doblados hacia arriba actúan como antenas).
- Utilice la lámina de metal según las recomendaciones de este manual.
- Utensilios metálicos usados durante la función Precision/Speed Cook (Cocción con Precisión/ Velocidad) o en la cocción con microondas (excepto con charolas provistas con el horno).
- Metal, tal como tiritas metálicas de seguridad, sujetadores para carne de ave o platos con borde de oro en el horno.
- Toallas de papel reciclado que contengan pedazos de metal pequeños que se utilizan en el horno.

▲ ADVERTENCIA RECIPIENTES DE COCINA SEGUROS DISEÑADOS PARA MICROONDAS

Asegúrese de utilizar recipientes de cocina adecuados durante la cocción a microondas. Se pueden utilizar la mayoría de las cacerolas, platos para cocinar, tazas de medir, tazas normales, cerámica o loza que no tengan bordes metálicos o vidriados con un recubrimiento metálico. Algunos recipientes de cocina se encuentran marcados como adecuados para microondas.

- Coloque los alimentos o recipiente para microondas directamente en la bandeja de vidrio transparente para cocinar sus alimentos.
- El uso de una charola metálica durante la cocción con microondas generará como resultado un rendimiento inferior de la cocción.
- Los utensilios de cocina pueden tornarse muy calientes debido a la transferencia de calor proveniente de los alimentos calentados. Podrían requerirse guantes de cocina para manipular los recipientes de cocina.
- No utilice productos de papel reciclado. Las toallas, servilletas y papel encerado fabricados de material reciclado pueden contener partículas metálicas que pueden causar arco voltaico o prender fuego. Se deben evitar los productos de papel que contienen nylon o filamentos de nylon, ya que también pueden incendiarse.
- Utilice las láminas metálicas únicamente como se indica en este manual. Cuando utilice la lámina de metal en el horno, mantenga la lámina por lo menos 1" alejada de los costados del horno.
- Si utiliza un termómetro de carne mientras cocina, asegúrese que sea seguro para utilizarse en hornos microondas.
- Algunas bandejas de espuma (como aquellas en las que se empaqueta la carne) tienen una tira de metal delgada empotrada en la parte inferior. Cuando se cocinan con microondas, el metal puede quemar el fondo del horno o encender una toalla de papel.
- Se puede utilizar toallas de papel, papel encerado y las envolturas plásticas para cubrir los platos con el propósito de mantener la humedad y prevenir los salpicones. Asegúrese de ventilar cortando la envoltura plástica para que pueda escapar el vapor.
- No todas las cubiertas plásticas son adecuadas para hornos microondas. Lea en la caja las instrucciones correspondientes.

LEA Y GUARDE ESTAS INSTRUCCIONES

INFORMACIÓN IMPORTANTE DE SEGURIDAD

LEA TODAS LAS INSTRUCCIONES ANTES DE USAR ESTE ELECTRODOMÉSTICO

⚠️ ADVERTENCIA RECIPIENTES DE COCINA SEGUROS DISEÑADOS PARA MICROONDAS (Cont.)

- Se deben cortar, perforar o ventilar como se indica en la caja las bolsas de cocina “hervibles” y bolsas plásticas cerradas herméticamente. De lo contrario, el plástico puede reventarse durante o inmediatamente después de la cocción, resultando en una posible lesión. También, los recipientes de almacenamiento plásticos deben al menos estar parcialmente descubiertos debido a que forman un sello muy ajustado. Al cocinar con recipientes cubiertos con envoltura plástica de manera muy ajustada, quite cuidadosamente la cubierta y dirija el vapor fuera y alejado de manos y rostro.
- Recipientes de cocina plásticos—Los recipientes de cocina diseñados para microondas son muy útiles, pero deben utilizarse con cuidado. Incluso el plástico diseñado para microondas podría no tolerar condiciones de sobre cocción, así

como los materiales de vidrio o cerámica y podrían suavizarse o carbonizarse si se exponen a períodos cortos de sobre cocción. En exposiciones más prolongadas a la sobrecocción, los alimentos y los recipientes de cocina podrían coger fuego.

- No utilice la rejilla del horno para cocinar en el microondas.

Siga las siguientes pautas:

1. Utilice plásticos seguros para microondas únicamente y utilícelos estrictamente según las especificaciones del fabricante.
2. No cocine en el microondas recipientes vacíos.



El plato giratorio siempre deberá estar en la ubicación correcta al usar el horno.



Coloque la comida directamente sobre la bandeja metálica para hornear, calentar o dorar por convección.

⚠️ ADVERTENCIA (En Algunos Modelos) UTENSILIO DE COCCIÓN SEGURA PARA LA COCCIÓN CON PRECISIÓN/ VELOCIDAD

- El horno y la compuerta se tornarán muy calientes cuando se utiliza la función de Precision/Speed Cooking.
- Los utensilios de cocina se tornarán muy calientes debido a la transferencia de calor proveniente de los alimentos calentados. Se requerirán guantes de cocina protectores para manipular los recipientes de cocina.
- No utilice tapas, recipientes o bolsas de cocción/asado fabricadas de láminas de metal, plástico, cera o papel cuando cocine con la función de cocción rápida.
- No cubra la base giratoria, parrilla de alambre, bandejas ni ninguna pieza del horno con lámina de metal. Esto provocará arqueo voltaico en el horno.
- Utilice la bandeja de metal antiadherente e la misma forma que utilizaría una bandeja o charola para hornear plana.
- Coloque los alimentos directamente en las bandejas cuando cocine, a menos que el horno le indique otra cosa.

- Puede utilizar en el horno cualquier plato diseñado para microondas. Las recetas del Libro de cocina Advantium se probaron en recipientes de cocina de vidrio Pyrex® y cacerolas de cerámica Corningware®. Los tiempos y resultados de cocción pueden variar cuando se utilizan otros tipos de recipientes diseñados para hornos microondas. Colóquelos directamente en las bandejas.

- El uso de la bandeja de vidrio claro al cocinar en velocidad resultará en un rendimiento inferior de la cocción y posibles fisuras sobre la bandeja de vidrio.

- Use solo bandejas metálicas especificadas para uso con este horno. Otras bandejas metálicas no fueron diseñadas para uso con este horno y resultarán en un rendimiento inferior de la cocción.



El plato giratorio siempre deberá estar en la ubicación correcta al usar el horno.



Coloque la comida directamente sobre la bandeja metálica para hornear, calentar o dorar por convección.

LEA Y GUARDE ESTAS INSTRUCCIONES

INFORMACIÓN IMPORTANTE DE SEGURIDAD

LEA TODAS LAS INSTRUCCIONES ANTES DE USAR ESTE ELECTRODOMÉSTICO

⚠ ADVERTENCIA (En Algunos Modelos) RECIPIENTES DE COCINA SEGUROS DISEÑADOS PARA HORNEAR, ASAR, CALENTAR, ACTIVAR Y TOSTAR

- El horno y la compuerta se tornarán muy calientes cuando se hornea, asa, calienta, activa o tuesta algo.
- Los recipientes de cocina se tornarán muy calientes. Se requerirán guantes de cocina protectores para manipular los recipientes de cocina.
- No utilice tapas, recipientes ni bolsas de cocción/asado fabricadas de láminas de metal, plástico, cera o papel cuando cocine con la función de asar o dorar.
- No cubra el plato giratorio, el estante parrilla del horno, las charolas o cualquier parte del horno con papel de aluminio. Esto ocasionará arcos eléctricos en el horno microondas/ por convección.
- Utilice la bandeja metálica antiadherente de la misma forma que utilizaría una bandeja o charola para hornear plana.
- Use la bandeja con rejilla del horno para hornear por convección o calentar en dos niveles.
- Coloque los alimentos directamente en las bandejas cuando cocine, a menos que el horno le indique hacer otra cosa.
- Puede utilizar en el horno cualquier plato diseñado para microondas. Las recetas del Libro de cocina Advantium se probaron en recipientes de cocina de vidrio Pyrex® y cacerolas de cerámica Corningware®. Los tiempos y resultados de cocción pueden variar cuando se utilizan otros tipos de recipientes diseñados para hornos microondas. Colóquelos directamente en las bandejas.
- Utilizar la bandeja de vidrio transparente cuando hornea, asa, calienta, activa o tuesta puede producir resultados insatisfactorios.



El plato giratorio siempre deberá estar en la ubicación correcta al usar el horno.



Coloque la comida directamente sobre la bandeja metálica para hornear, calentar o dorar por convección.

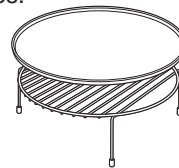

Coloque la comida directamente en la bandeja para hornear de aluminio sobre el estante rejilla del horno, y coloque ambos sobre la bandeja metálica no adherente, al hornear en dos niveles, asar o dorar comidas.

PRECAUCIONES PARA EVITAR LA POSIBLE EXPOSICIÓN A ENERGÍA DE MICROONDAS EXCESIVA

- (a) **No intente hacer** funcionar el horno con la compuerta abierta ya que esto puede provocar exposición peligrosa a la energía de microondas. Es importante no forzar ni dañar los seguros.
- (b) **No coloque** ningún objeto entre la parte frontal del horno y la compuerta, ni permita que se acumulen residuos de producto limpiador o detergente, suciedad o polvo en las superficies de sellado.
- (c) **No haga funcionar** el horno si se encuentra dañado. Es particularmente importante cerrar bien la compuerta
 - (1) la compuerta (doblada o curvada),
 - (2) las bisagras y pestillos (rotos o flojos),
 - (3) sellos de la compuerta y superficies de sellado.
- (d) **El horno no debe** ser ajustado o reparado por ninguna persona, excepto por personal de mantenimiento calificado.

⚠ ADVERTENCIA AVISO: MARCAPASOS

La mayoría de los marcapasos se encuentran protegidos contra la interferencia de productos electrónicos, incluyendo los microondas.

Sin embargo, los pacientes que tengan marcapasos deberían consultar a sus médicos si tienen alguna duda.

LEA Y GUARDE ESTAS INSTRUCCIONES

INFORMACIÓN IMPORTANTE DE SEGURIDAD

LEA TODAS LAS INSTRUCCIONES ANTES DE USAR ESTE ELECTRODOMÉSTICO

INFORMACIÓN DE SEGURIDAD DEL HORNO INFERIOR

⚠️ ADVERTENCIA Lea todas las instrucciones de seguridad antes de utilizar este producto. No seguir estas instrucciones puede generar un incendio, una descarga eléctrica, lesiones corporales o la muerte.

⚠️ ADVERTENCIA INSTRUCCIONES GENERALES DE SEGURIDAD

- Use este aparato sólo con el objetivo para el que fue creado, como se describe en este Manual del Propietario.
 - Solicite que un instalador calificado instale su estufa y que esté adecuadamente conectada a tierra, de acuerdo con las instrucciones de instalación provistas.
 - Cualquier ajuste, reparación o servicio técnico no recomendado específicamente en este manual deberá ser realizado SOLO por un instalador o técnico del servicio con calificación en estufas.
 - Antes de realizar cualquier clase de reparación, desenchufe la cocina o desconecte el suministro eléctrico desde el panel de distribución doméstico quitando el fusible o desconectando el interruptor de circuitos.
 - Asegúrese de que todos los materiales de embalaje sean retirados de la estufa antes de su uso, a fin de evitar que los mismos se incendien.
 - Evite rayones o impactos sobre las puertas de vidrio, placas de cocción o paneles de control. Hacer esto podrá producir la rotura de vidrios.
 - No cocine sobre un producto con un vidrio roto. Se podrán producir descargas, incendios o cortes.
 - No deje a los niños solos o sin atención en un área donde un aparato esté en uso. Nunca debe permitirse que se suban, sienten o paren en cualquier parte de este aparato.
- ⚠️ PRECAUCIÓN**
- No guarde ítems de interés para los niños en los gabinetes que están sobre o en la parte superior de una estufa; si los niños trepan sobre la estufa para alcanzar estos artículos podrán sufrir lesiones graves.
 - Nunca use el electrodoméstico para calentar o calefaccionar la habitación.
 - No permita que nadie se trepe, se pare o cuelgue de la puerta del horno, del cajón o la placa de cocción. Se podrá dañar la estufa o provocar su caída, ocasionando lesiones graves o la muerte.
 - Sólo use agarraderas secas: las agarraderas húmedas o mojadas colocadas en superficies calientes pueden provocar quemaduras de vapor. No permita que las agarraderas tengan contacto con las unidades de la superficie ni con los elementos para calentar del horno. No utilice toallas u otras telas gruesas en lugar de una agarradera.
 - No toque los quemadores, planchas (en algunos modelos), parrillas (en algunos modelos), la superficie de cocción o los elementos calefactores del horno, ni la superficie interior del horno. Estas superficies podrán permanecer lo suficientemente caliente como para quemar durante un período de tiempo prolongado luego de la cocción, incluso aunque ya no parezcan estar encendidas o calientes.
 - Durante y después del uso, no toque ni permita que telas u otros materiales inflamables toquen cualquier área interior del horno; espere hasta que haya pasado un tiempo suficiente hasta que se enfrien. Otras superficies del electrodoméstico se podrán calentar lo suficiente como para ocasionar lesiones. Las superficies potencialmente calientes incluyen quemadores o elementos calefactores, parrillas (en algunos modelos), superficie de cocción, aberturas de la ventilación del horno, superficies cercanas a las aberturas, grietas alrededor de la puerta del horno, partes con marcos metálicos por encima de la puerta, cualquier protección trasera, o repisas ubicadas encima de una superficie de cocción.
 - No caliente recipientes cerrados de alimentos. Podría haber una acumulación de presión en el recipiente y éste podría explotar, provocando lesiones.
 - Cocine la comida completamente para evitar que se produzcan enfermedades a partir de la comida. USDA y FDA brindan las recomendaciones de temperatura mínima para una comida segura. Utilice un termómetro para tomar la temperatura de la comida y haga controles en diferentes ubicaciones.
 - Mantenga limpia la campana del ventilador y los filtros de grasa, con el fin de conservar una buena ventilación y de evitar incendios con grasa. En caso de incendio, apague el ventilador. Si el extractor se encuentra en funcionamiento, podrá esparcir las llamas.

LEA Y GUARDE ESTAS INSTRUCCIONES

INFORMACIÓN IMPORTANTE DE SEGURIDAD

LEA TODAS LAS INSTRUCCIONES ANTES DE USAR ESTE ELECTRODOMÉSTICO

▲ ADVERTENCIA MANTENGA LOS MATERIALES INFLAMABLES ALEJADOS DE LA ESTUFA

Si esto no se cumple, se podrán sufrir lesiones personales graves o incendios.

- No almacene o utilice materiales inflamables dentro de un horno o cerca de la estufa, tales como papel, plástico, agarraderas, telas, recubrimientos de pared, cortinas y gasolina u otros vapores y líquidos inflamables.
- Nunca use vestimentas holgadas o amplias mientras utilice el aparato. Estas vestimentas pueden prenderse fuego si entran en contacto con superficies calientes, provocando quemaduras graves.
- No permita que la grasa de la cocción u otros materiales inflamables se acumulen dentro de la estufa o en su cercanía. La grasa dentro del horno o sobre la estufa puede encenderse.
- No guarde materiales inflamables ni ítems sensibles a la temperatura dentro del electrodoméstico.
- Limpie las campanas de ventilación de forma frecuente. No se debe permitir la acumulación de grasa en la campana o el filtro.
- (En algunos modelos) Funcionamiento Remoto - Este electrodoméstico permite su configuración para permitir un funcionamiento remoto en cualquier momento.

▲ ADVERTENCIA EN CASO DE INCENDIO, SIGA LOS SIGUIENTES PASOS PARA EVITAR LA PROPAGACIÓN DEL FUEGO

- No utilice agua en incendios de grasa. Nunca levante una sartén en llamas. Apague los controles. Apague una sartén en llamas sobre una unidad de superficie cubriendo la sartén por completo con una tapa que ajuste bien, una plancha para galletas o una bandeja plana. Utilice un químico seco multiuso o un extintor de incendios de espuma.
- Si hay un incendio en el horno durante el horneado, apáguelo cerrando la puerta del horno y apagando el control o usando un químico seco multiuso o un extintor de incendios de espuma.
- Si hay un incendio en el horno durante la auto-limpieza, apague el horno y espere a que el incendio se consuma. No abra la puerta del horno a la fuerza. El ingreso de aire fresco a temperaturas de auto-limpieza puede provocar una explosión de llamas desde el horno. No seguir esta instrucción puede provocar quemaduras graves.

▲ ADVERTENCIA INSTRUCCIONES DE SEGURIDAD DEL HORNO

- Manténgase alejado del horno al abrir la puerta del mismo. El aire caliente o el vapor que sale puede causar quemaduras en las manos, rostro y/u ojos.
- No use el horno si un elemento de calentamiento genera un punto brillante durante el uso o aparecen otros signos de daños. Un punto brillante indica que el elemento para calentar puede fallar y generar una posible quemadura, incendio o descarga eléctrica. Apague el horno de inmediato y solicite a un técnico calificado del servicio que reemplace el elemento para calentar.
- Mantenga desobstruida la ventilación del horno.

LEA Y GUARDE ESTAS INSTRUCCIONES

INFORMACIÓN IMPORTANTE DE SEGURIDAD

LEA TODAS LAS INSTRUCCIONES ANTES DE USAR ESTE ELECTRODOMÉSTICO

⚠ ADVERTENCIA INSTRUCCIONES DE SEGURIDAD DEL HORNO (Cont.)

- Nunca coloque los utensilios de cocina, piedras para pizza u horneado o cualquier otro tipo de aluminio o cobertor en la base del horno. Estos ítems pueden atrapar el calor o derretirse, ocasionando daños sobre el producto y el riesgo de descargas, humo o incendios.
- Coloque los estantes del horno en la ubicación deseada mientras éste se encuentra frío. Si es necesario mover el estante mientras el horno está caliente, tenga cuidado de evitar tocar superficies calientes y evite que el mango de la olla tenga contacto con el elemento calentador en el horno.
- No deje productos tales como papel, utensilios de cocina ni comida en el horno cuando éste no se encuentre en uso. Los artículos guardados en el horno se pueden incendiar.
- No deje artículos sobre la superficie de cocción cerca de la ventilación del horno. Los ítems se podrán sobrecalentar, y existe el riesgo de incendio o quemaduras.
- Nunca ase con la puerta abierta.
- Mantenga el horno libre de acumulación de grasa. La grasa del horno se puede incendiar.
- Al usar las bolsas para cocinar o dorar en el horno, siga las instrucciones del fabricante.
- **PELIGRO DE DESCARGA O QUEMADURAS:** Antes de reemplazar la bombilla de luz del horno, desconecte la conexión eléctrica del horno desde el fusible principal o desde el panel del disyuntor. Si esto no se cumple, se podrá producir una descarga eléctrica o un incendio.

- **⚠ PRECAUCIÓN** **RIESGO DE INCENDIO:** La tapa de vidrio y la bombilla de luz se deberán retirar cuando estén frías. Tocar el vidrio caliente sin protección en las manos o con una tela húmeda podrá ocasionar quemaduras.
- No use ningún tipo de aluminio o cobertor para cubrir el fondo del horno o cualquier parte del horno, excepto como se describe en este manual. Los cobertores de horno pueden atrapar el calor o derretirse, ocasionando daños sobre el producto y el riesgo de descargas, humo o incendios.

⚠ ADVERTENCIA INSTRUCCIONES DE SEGURIDAD DEL HORNO CON LIMPIEZA AUTOMÁTICA (en algunos modelos)

La función de limpieza automática usa el horno en temperaturas lo suficientemente altas como para consumir la suciedad de comida que haya dentro del horno. Para un funcionamiento seguro, siga estas instrucciones.

- No toque las superficies del horno durante el ciclo de limpieza automática. Mantenga a los niños alejados del horno durante la limpieza automática. Si no se siguen estas instrucciones, se podrán producir quemaduras.
- Antes de utilizar el ciclo de limpieza automática, retire las ollas, estantes de metal brillante del horno y otros utensilios que haya en el horno. Sólo se pueden dejar dentro del horno los estantes para horno de color oscuro con revestimiento de porcelana. No hacer esto podrá ocasionar daños sobre estos ítems y el horno, y presentar una posible quemadura o riesgo de incendio.

LEA Y GUARDE ESTAS INSTRUCCIONES

INFORMACIÓN IMPORTANTE DE SEGURIDAD

LEA TODAS LAS INSTRUCCIONES ANTES DE USAR ESTE ELECTRODOMÉSTICO

▲ ADVERTENCIA INSTRUCCIONES DE SEGURIDAD DEL HORNO CON LIMPIEZA AUTOMÁTICA (en algunos modelos) (Cont.)

- Antes de utilizar el ciclo de limpieza automática, limpie la grasa y restos de comida que haya en el horno. Una cantidad excesiva de grasa se puede incendiar, lo cual puede producir daños con humo en su hogar.
- Si el modo de limpieza automática funciona de forma incorrecta, apague el horno y desconecte el suministro de corriente. Solicite el servicio de un técnico calificado.
- No use limpiadores para horno. No se deberá usar limpiadores comerciales para horno ni revestimientos de protección para hornos de ningún tipo en o alrededor de cualquier parte del horno, a menos que cuente con certificación para uso en un horno con limpieza automática.
- No limpie la junta de la puerta. La junta de la puerta es esencial para un buen sellado. Se debe tener cuidado de no frotar, dañar ni mover la junta.
- **IMPORTANTE:** La salud de algunas aves es extremadamente sensible a los humos emitidos durante el ciclo de limpieza automática de cualquier estufa. Coloque las aves en otra habitación bien ventilada.

▲ ADVERTENCIA EQUIPO DE ACCESO REMOTO INSTALADO (Algunos modelos)

Este dispositivo cumple con la Parte 15 de la Normativa de la FCC. Su funcionamiento está sujeto a las dos condiciones siguientes:

(1) Este dispositivo no deberá causar interferencias nocivas, y (2) este dispositivo deberá aceptar cualquier interferencia recibida, incluyendo interferencias que puedan generar un funcionamiento no deseado. El equipo de comunicación inalámbrica instalado en esta estufa fue probado y cumple con los límites establecidos para un dispositivo digital de Clase B, de acuerdo con la parte 15 de la Normativa de la FCC.

Estos límites fueron diseñados para:

(a) brindar una protección razonable contra interferencias nocivas en una instalación residencial. Este equipo genera, usa y puede emitir energía de radiofrecuencia y, si no se instala y utiliza de acuerdo con las instrucciones, puede ocasionar interferencias perjudiciales en las comunicaciones de radio. Sin embargo, no se garantiza que no se presenten interferencias en una instalación en particular. Si el equipo provoca

interferencias perjudiciales para la recepción de radio o televisión, lo cual puede comprobar encendiendo y apagando el equipo, se aconseja al usuario que intente corregir la interferencia con una de las siguientes medidas:

- Reoriente o reubique la antena receptora.
- Aumente la separación entre el equipo y el receptor.
- Conecte el equipo a un tomacorriente de un circuito diferente del tomacorriente al que se encuentra conectado el receptor.
- Para solicitar ayuda, consulte con el proveedor minorista o a un técnico experimentado de radio/ TV.

(b) tolerar cualquier interferencia recibida, incluyendo las interferencias que puedan provocar un funcionamiento no deseado del dispositivo. Observe que todos los cambios o modificaciones sobre el dispositivo de comunicación inalámbrico instalado en este horno que no estén expresamente aprobados por el fabricante podrían anular la autoridad del usuario para operar el equipamiento..

LEA Y GUARDE ESTAS INSTRUCCIONES

INFORMACIÓN IMPORTANTE DE SEGURIDAD

LEA TODAS LAS INSTRUCCIONES ANTES DE USAR ESTE ELECTRODOMÉSTICO

FORMA ADECUADA DE DESCARTAR SU ELECTRODOMÉSTICO

Descarte o recicle su electrodoméstico de acuerdo con las Regulaciones Federales y Locales. Comuníquese con las autoridades locales para descartar o reciclar su electrodoméstico de forma ambientalmente segura.

Cómo Retirar la Película Protectora de Envío y la Cinta de Embalaje

Con cuidado tome un extremo de la película protectora de envío con los dedos y lentamente retire la misma de la superficie del electrodoméstico. No utilice ningún producto filoso para retirar la película. Retire toda la película antes de usar el electrodoméstico por primera vez.

Para asegurar que no haya daños sobre el acabado del producto, la forma más segura de retirar el adhesivo de la cinta de embalaje en electrodomésticos nuevos es aplicando un detergente líquido hogareño para lavar platos. Aplique con una tela suave y deje que se seque.

NOTA: El adhesivo deberá ser eliminado de todas las partes. No se puede retirar si se hornea con éste dentro.

Tenga en cuenta las opciones de reciclaje del material de embalaje de su electrodoméstico.

LEA Y GUARDE ESTAS INSTRUCCIONES

Features

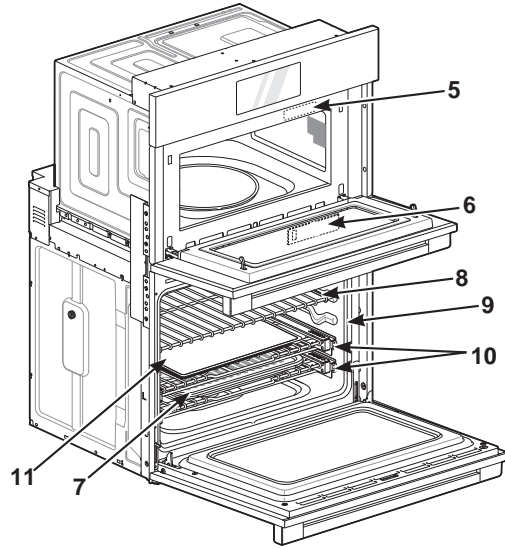
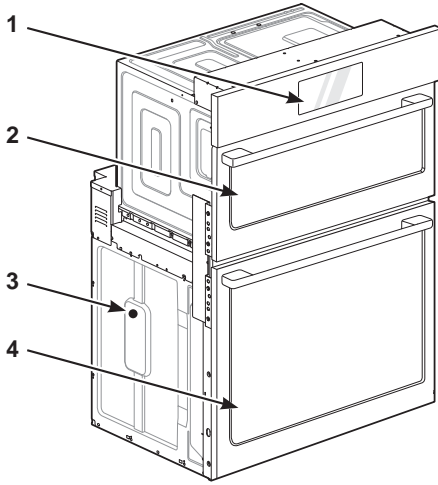

- | | | |
|-------------------|---|--------------------|
| 1 Control Panel | 5 Rating Label, Model and Serial Number Plate | 8 Standard Racks |
| 2 Upper Oven Door | 6 Steam Feeder Tank | 9 Gasket |
| 3 Spacer | 7 Broiler Pan and Grid | 10 Extension Racks |
| 4 Lower Oven Door | | 11 Air Fry Tray |

NOTE: The model and serial number can be verified at the rating label.

UPPER OVEN COOKING ACCESSORIES

The turntable rotates in both directions to help food cook more evenly. Do not operate the microwave oven without the glass tray in place.

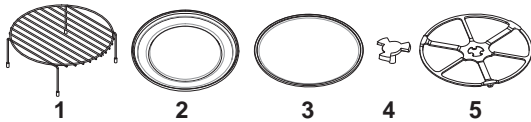

- 1 Rack (for the Convection Bake, Broil, and Speed Cook functions)
- 2 Metal tray (For the Convection Bake, Broil, and Speed Cook functions)
- 3 Turntable Glass tray (For the Microwave and Defrost functions)
- 4 Shaft
- 5 Rotating ring

NOTE

- Contact GE Appliances at GEAppliances.com/contact if any accessories are missing.
- For your safety and for extended product life, only use authorized components.
- The manufacturer is not responsible for product malfunction or accidents caused by the use of separately purchased, unauthorized components or parts.
- The images in this guide may be different from the actual components and accessories, which are subject to change by the manufacturer without prior notice for product improvement purposes.
- Do not remove extension racks from the base packing. The extension racks are wrapped separately for the top and bottom ovens.

LOWER OVEN COOKING ACCESSORIES

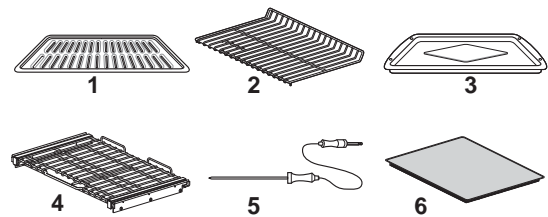

- 1 Grid
- 2 Standard rack
- 3 Broiler pan
- 4 Extension rack (2 ea)
- 5 Meat probe
- 6 Air fry tray

Oven Controls

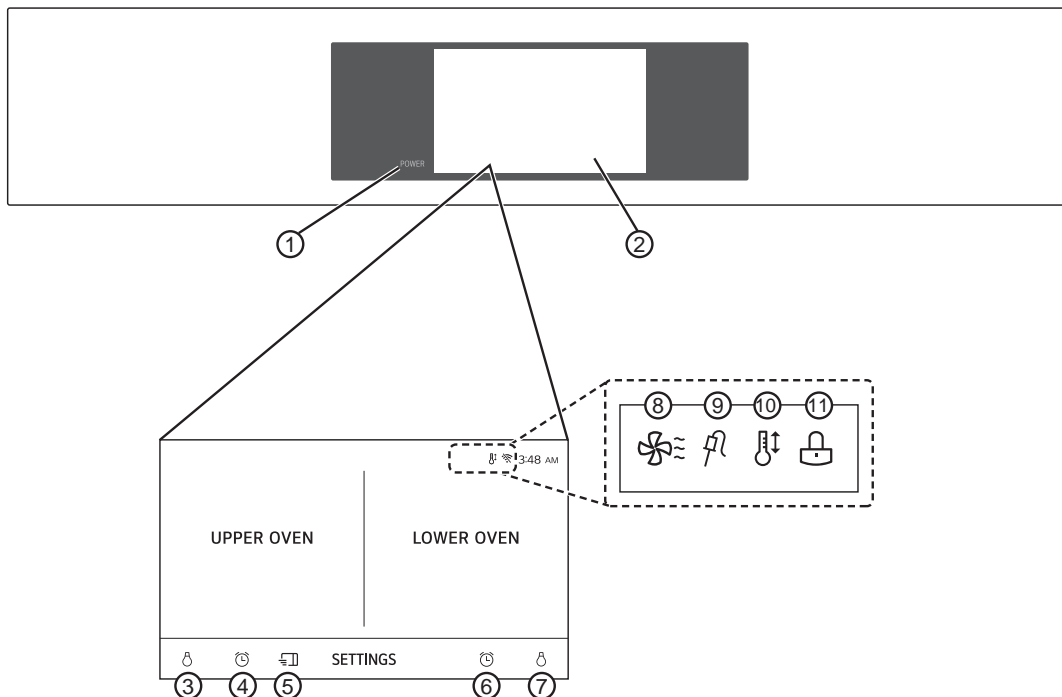

1. **Power Key**
2. **LCD Touchscreen for Ovens**
3. **Lamp Icon (Upper Oven):** Touch to turn light on/off.
4. **Timer Icon (Upper Oven):** Touch to set a timer.
5. **Microwave Quick Start:** Touch to start Microwave mode quickly.
6. **Timer Icon (Lower Oven):** Touch to set a timer.
7. **Lamp Icon (Lower Oven):** Touch to turn light on/off.
8. **Oven Cooling Icon:** Appears during or after oven operation to indicate cooling fan is running in oven.
9. **Probe Icon:** Appears when probe is connected.
10. **Auto Conversion Icon:** Appears when Convection Auto Conversion is turned on.
11. **Lock Icon:** Appears when Lockout is on.

ENERGY SAVING TIPS

- Multiple-rack cooking saves time and energy. Whenever possible, cook foods requiring the same cooking temperature together in one oven.
- For optimal performance and energy savings, follow the guides for proper rack and pan placement.
- Reduce energy use by cleaning light oven soil with the **EasyClean** feature instead of self-clean.
- Avoid opening the oven door more than necessary during use. This helps the oven maintain temperature, prevents unnecessary heat loss, and saves on energy use.

Oven Settings

GETTING STARTED

When turning on the oven for the first time, adjust the settings to suit your preferences.

1. Connect oven to power source and turn on.
2. Select the desired language and touch **NEXT**.

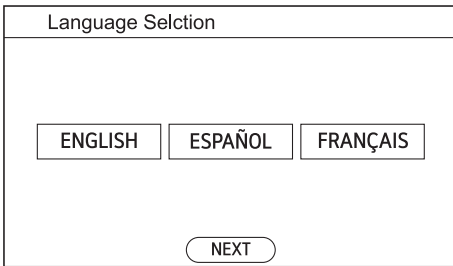

3. Set the correct time and choose between a 12-hour and 24-hour time format. Touch **NEXT**.
4. If desired, change the default clock theme by swiping through the examples. Touch **NEXT**.

SETTINGS

To adjust settings after the initial setup, touch the display to open the Main screen. Touch **SETTINGS** at the bottom center of the Main screen.

Swipe the screen or touch the < > arrow keys to navigate through the SETTINGS screens.

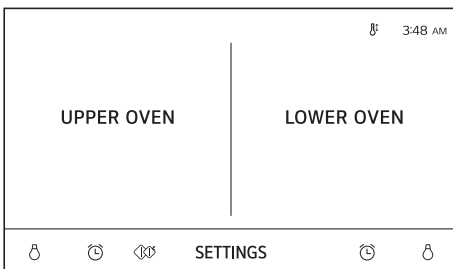

Location of Settings:

Page 1: Microwave Quick Start, Lockout, Time, Clock Themes, Sabbath Mode, Brightness

Page 2: Display, Convection Auto Conversion, Language Selection, Volume, Preheat Alarm, Temperature Adjustment

Page 3: Temperature Units, Program Update, Demo Mode, Factory Data Reset, Open Source License

Microwave Quick Start

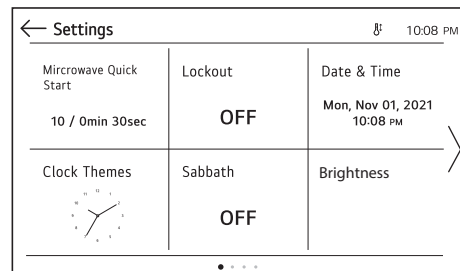

Use the Microwave Quick Start setting to adjust the preset cook time that is activated when you press **Start** without setting a time. The power level of the microwave and preset time can be set from 1 to 10 and 1 second to 5 minutes.

Setting Cook Time:

1. Touch **SETTINGS** at the center bottom of the main screen.
2. Touch **Microwave Quick Start** on the first SETTINGS screen.
3. Set the power level and cook time.
4. Touch **OK**.

Lockout

The Lockout feature automatically prevents most oven controls from being turned on. It does NOT disable the clock, timer and the interior oven light.

Lock:

1. Touch **SETTINGS** at the center bottom of the Main screen.
2. Touch **Lockout** on the first SETTINGS screen.

Oven Settings

SETTINGS (Cont.)

- When Lockout is turned on, the lock icon appears at the top of the display.

Unlock:

- Touch any part of screen while Lockout is on.
- A popup screen appears. Touch **Unlock** for 3 seconds.
- The lock icon disappears from the top of the display.

Time

The time shows in the LCD display when the ovens are not in use.

Setting Time:

- Touch **SETTINGS** at the center bottom of the Main screen. Then touch **Time** on the Settings screen.
- Touch **Time** and scroll to set the correct hour and minutes. You can also touch the number pad icon and enter the desired numbers.
- Select either a 12-hour or 24-hour clock mode (12H/24H).
- Touch **OK**.

CLOCK THEMES

There are 3 different clock themes available, including analog and digital clocks.

- Touch **SETTINGS** at the center bottom of the Main screen.
- Touch **Clock Themes** on the first SETTINGS screen and swipe to browse through the clock themes.
- Select a clock theme and touch **OK**.

SABBATH

Sabbath mode is used on the Jewish Sabbath and Holidays.

While the oven is in Sabbath mode, the temperature cannot be changed and the timer, light, and alarm functions are disabled. Only the cooking mode and set temperature appear in the display.

NOTE: If the oven light is turned ON and the Sabbath mode is active, the oven light will stay OFF. Sabbath mode can only be used in Bake mode.

Setting Sabbath:

- Disconnect the probe. The Probe function is not available in Sabbath mode.
- Touch **SETTINGS** at the center bottom of the Main screen, and touch **Sabbath** in the first SETTINGS screen.
- Read the instructions, and touch **NEXT**.
- Set the desired temperature and cook time. Any cook time can be set from 1 minute to 73 hours 59 minutes. Touch **START**.
- To stop Sabbath mode, press **POWER** on the LCD display.

NOTE:

- If a cook time is set, the oven turns off automatically at the end of the cook time, without chiming. The oven remains in Sabbath mode, but is turned off.
- If no cook time is set, the oven will not automatically turn off.
- After a power failure, the display will turn back on in Sabbath mode, but the oven will be off.
- In Sabbath mode, the upper oven functions are blocked.

BRIGHTNESS

Adjust the brightness of the LCD display from 20% to 100% in increments of 20%.

- Touch **SETTINGS** at the center bottom of the Main screen, swipe to the second SETTINGS screen, and touch **Brightness**.

Oven Settings

BRIGHTNESS (Cont.)

- Adjust the display brightness by touching and dragging the dot across the bar, by tapping anywhere on the bar, or by touching **+** or **-**.

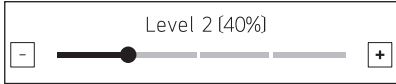

- Touch **OK**.

DISPLAY

Set the length of time before the display sleeps. There are three options you can select.

- **ON** : Always on
- **OFF** : Automatically turns off if idle for 30 minutes.
- **Night OFF** : Turns off from 10:00 PM to 5:00 AM.

Setting Display Option:

- Touch **SETTINGS** at the center bottom of the Main screen, swipe to the second **SETTINGS** screen, and touch **Display**.
- Select the desired option.
- Touch **OK**.

CONVECTION AUTO CONVERSION

There is no need to remember to convert standard recipe temperatures for convection cooking.

Convection Auto Conversion automatically subtracts 25°F/14°C from the set temperature when a convection cooking mode is selected. The converted temperature appears in the display once preheating is finished.

For example, select **Convection Bake** and enter **350°F**. The temperature will auto-convert to **325°F** and display the converted temperature.

Convection Auto Conversion is turned ON by default.

Turning Convection Auto Conversion On/Off:

- Touch **SETTINGS** at the center bottom of the Main screen, swipe to the second **SETTINGS** screen, and touch **Convection Auto Conversion**.
- Select **ON** or **OFF**.
- When Convection Auto Conversion is ON, the icon appears at the top of the display.

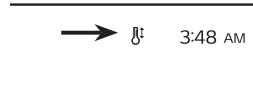

NOTE: If Convection Auto Conversion is ON, the icon flashes in the display while cooking in a convection mode.

LANGUAGE SELECTION

Set the display language to English, Spanish, or French.

- Touch **SETTINGS** at the center bottom of the Main screen, swipe to the second **SETTINGS** screen, and touch **Language Selection**.
- Select the desired language.
- Touch **OK**.

VOLUME

- Touch **SETTINGS** at the center bottom of the Main screen, swipe to the second **SETTINGS** screen, and touch **Volume**.
- Select **Mute**, **Low**, or **High**.
- Touch **OK**.

PREHEAT ALARM LIGHT

When the oven reaches its set-temperature, the preheating alarm light flashes 5 times or until the oven door is opened.

You can turn the preheat alarm light on or off.

Oven Settings

PREHEAT ALARM LIGHT (Cont.)

1. Touch **SETTINGS** at the center bottom of the Main screen, swipe to the third SETTINGS screen, and touch **Preheat Alarm Light**.
2. Select **ON** or **OFF**.
3. Touch **OK**.

TEMPERATURE ADJUSTMENT

Your new oven may cook differently than the one it replaced. Use your new oven for a few weeks to become more familiar with it before changing the temperature settings. If after familiarizing yourself with the new oven, you still think that it is too hot or too cold, you can adjust the oven temperature yourself.

1. Touch **SETTINGS** at the center bottom of the Main screen, swipe to the third SETTINGS screen, and touch **Temperature Adjustment**.
2. To make large adjustments, drag the central indicator toward the **+** or **-** ends of the scale or tap a location on the scale. To make small adjustments, tap **+** or **-** to raise or lower the thermostat in 1-degree increments. Tap and hold **+** or **-** to scroll up or down the scale.
3. When the desired change appears above the range, touch **OK**.

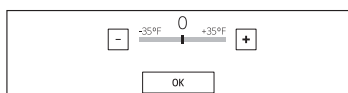

TEMPERATURE UNITS

Set the oven temperature display to show either Fahrenheit or Celsius units.

The oven defaults to Fahrenheit unless changed by the user.

1. Touch **SETTINGS** at the center bottom of the Main screen, swipe to the third SETTINGS screen, and touch **Temperature Units**.
2. Select °F or °C.
3. Touch **OK**.

DEMO MODE

Demo Mode for showroom use only. The oven will not heat up.

1. Touch **SETTINGS** at the center bottom of the Main screen, swipe to the third SETTINGS screen, and touch **Demo Mode**.
2. Select either the **ON** or **OFF** mode.
3. Touch **OK**.

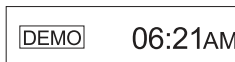

NOTE:

- When Demo Mode is on, the appliance will not heat up.
- The oven Demo Mode icon appears in the display if the Demo Mode is on.

FACTORY DATA RESET

This function returns all settings to the factory defaults.

NOTE: All stored data will be deleted.

1. Touch **SETTINGS** at the center bottom of the Main screen, swipe to the fourth SETTINGS screen, and touch **Factory Data Reset**.
2. If you want to reset data to the factory defaults, touch **RESET** and then **OK**.

OPEN SOURCE LICENSE

This screen displays a list of the open source software contained in this product. Refer to the indicated licenses for the terms and conditions of their use.

- 1 Touch **SETTINGS** at the center bottom of the Main screen and swipe to the fourth Settings screen.
- 2 Touch **Open Source License**.

Oven Settings

OPEN SOURCE LICENSE (Cont.)

Open Source Software Notice Information

To obtain the source code that is contained in this product, under GPL, LGPL, MPL, and other open source licenses that have the obligation to disclose source code, and to access all referred license terms, copyright notices and other relevant documents, please visit <https://opensource.lge.com>.

LG Electronics will also provide open source code to you on CD-ROM for a charge covering the cost of performing such distribution (such as the cost of media, shipping, and handling) upon email request to opensource@lge.com.

This offer is valid to anyone in receipt of this information for a period of three years after our last shipment of this product.

OVEN COOLING

The oven cooling icon appears in the display if the temperature inside the oven is high during or after operation. The icon disappears if the oven temperature is below 210°F (100°C).



TIMER

The oven timers don't affect oven operation or cooking time. Use them as extra kitchen timers. Once the time runs out, the oven chimes and "Upper timer finished" appears in the display.

1. Touch either **clock icon** at the bottom of the display.



2. Scroll through the numbers in the popup until the desired time appears in the display, or touch the number pad icon to enter the numbers directly, and touch **OK**.

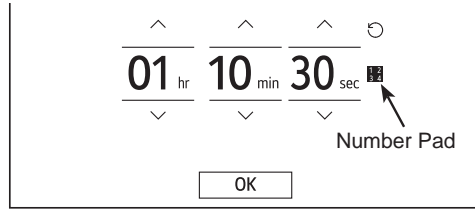

3. The time remaining appears next to the clock icon in the display.

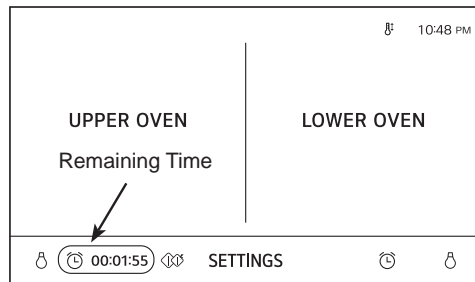

Adjusting or Cancelling the Timer:

1. Touch the **remaining time next to the clock icon** in the display.
2. To cancel the timer, touch the **Reset icon** in the popup. Then touch **OK**.

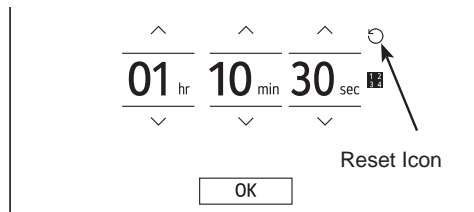

3. To adjust the time, scroll the numbers in the popup until the desired time appears. Then touch **OK**.
4. The remaining time in the display is adjusted.

Upper Oven

BEFORE USING

- Do not strike the control panel with silverware, cookware, etc. It may be damaged or broken.
- Always be careful when taking cookware out of the oven. Some dishes absorb heat from the cooked food and may be hot. See the Cookware Guide section for more information.
- To avoid breakage, allow cookware to cool before rinsing or submerging in water. Always allow the turntable to cool before removing it from the oven.
- Use thermometers that have been approved for microwave oven cooking.
- The turntable must always be in place when you operate the oven.
- The wire rack should not be used for Precision Cook or microwave cooking to prevent arcing.

MICROWAVE COOKWARE GUIDE

Microwave-Safe Cookware:

■ Ovenproof Glass

Ovenproof glassware that is treated for high intensity heat so it is heat-resistant is microwave-safe.

Use utility dishes, loaf dishes, pie plates, cake plates, liquid measuring cups, casseroles and bowls without metal rims.

Do not use delicate glassware, such as tumblers or wine glasses, as these might shatter when heated.

■ Plastic

Plastic Storage Containers: Use plastic dishes, cups, semi-rigid freezer containers and plastic bags only for short cooking times. Do not use them when cooking food for long periods or at high power levels, as the hot food will eventually warp or melt the plastic.

Plastic wrap (as a cover): Lay the plastic wrap loosely over the dish and press it to the sides. Vent plastic wrap by turning back one edge slightly to allow excess steam to escape. The dish should be deep enough so that the plastic wrap will not touch the food. As the food heats it may

melt the plastic wrap wherever the wrap touches the food.

Plastic Cooking Bags: Provided they are specially made for cooking, cooking bags are microwave safe. Remember to make a slit in the bag so that steam can escape. Never use ordinary plastic bags for cooking in the microwave oven, as they will melt and rupture.

■ Paper

Use paper towels, waxed paper, paper napkins, and paper plates with no metal rims or design. Look for the manufacturer's label for use in the microwave oven.

Paper plates and containers are convenient and safe to use in the microwave oven, provided that the cooking time is short and foods to be cooked are low in fat and moisture. Paper towels are also very useful for wrapping foods and for lining baking trays in which greasy foods such as bacon are cooked. Avoid colored paper products as the color may run. Do not use recycled paper products in the microwave oven. They may contain impurities which could cause arcing or fires when used in the microwave.

■ Tableware

Do not put plates with painted decoration in the oven, as the paint may contain metal and cause arcing.

Microwave-Unsafe Cookware:

■ Metal Containers/Metal Decoration

Never use metal or metal-rimmed cookware in the microwave oven.

Microwaves cannot penetrate metal. They will bounce off any metal object in the oven and cause arcing, an alarming phenomenon that resembles lightning.

Metal shields the food from microwave energy and produces uneven cooking. Also avoid metal skewers, thermometers, foil trays, metal-rimmed or metal-banded dinnerware, casserole dishes, etc. The metal rim interferes with normal cooking and may damage the oven.

Upper Oven

MICROWAVE COOKWARE GUIDE (Cont.)

■ Aluminum Foil

Avoid large sheets of aluminum foil because they hinder cooking and may cause harmful arcing.

Use small pieces of foil to shield poultry legs and wings.

Keep ALL aluminum foil at least 1” (2.54cm) from the side walls and door of the oven.

■ Wood

Wood bowls and boards will dry out and may split or crack when you use them in the microwave oven.

Baskets react in the same way.

■ Tightly Covered Cookware

Be sure to leave openings for steam to escape from covered containers.

Pierce plastic pouches of vegetables or other food items before cooking.

Tightly closed pouches could explode.

■ Brown Paper

Avoid using brown paper bags.

They absorb too much heat and could burn.

■ Flawed or Chipped Cookware:

Any container that is cracked, flawed, or chipped may break in the oven.

■ Metal Twist Ties

Remove metal twist ties from plastic or paper bags.

They become hot and could cause a fire.

COOKING TIPS

Carefully monitor the food in the microwave oven while it is cooking. Directions given in recipes to elevate, stir, etc., are the minimum steps recommended. If food is overcooked (dry), undercooked, or unevenly cooked, make adjustments before or during cooking to correct the problem.

■ Overcooked or Dry Food

Sprinkling: Sprinkle low-moisture foods such as roasts and vegetables with water before cooking, or cover them to retain moisture.

Density: Light, porous food such as cakes and breads cook more quickly than heavy, dense foods such as roasts and casseroles.

Shielding: Cover the corners of square dishes with small strips of aluminum foil to prevent overcooking. Don't use too much foil, and secure the foil to the dish. Foil can cause arcing if it gets too close to the oven walls during cooking.

Bones and Fat: Bones conduct heat, and fat cooks more quickly than meat. Take care with bony or fatty cuts of meat.

■ Undercooked Food

Covering: Cover food with a microwave-safe lid, parchment paper (not waxed paper), or plastic wrap to trap heat and steam and cook food more quickly.

Standing Time: Let food stand for several minutes after it is removed from the oven to allow it to finish cooking and help flavors blend and develop.

Quantity: The more food you place in the oven, the longer the required cooking time.

Temperature: Ice-cold ingredients take much longer to cook than room temperature ingredients.

Upper Oven

COOKING TIPS (Cont.)

■ Unevenly Cooked Food

Stirring: Stir food from the outside toward the center during cooking, as food at the outside of the dish heats more quickly.

Arranging: Turn food over several times during cooking. The upper portions of thick foods cook more quickly than the lower portions. Thick or dense foods can be elevated so that microwaves can be absorbed by the underside and center of the foods.

Shaping: Place the thickest portions of foods like meat, poultry or fish toward the outside of the cookware to help them cook more evenly. If possible, shape foods into thin rounds or rings.

■ Foods with Skin, Shell or Membrane

Skin or Membrane: Pierce the outsides of foods like potatoes, sausages, or egg whites or yolks before cooking.

Shell: Pierce or remove the shells from eggs, clams, oysters, or other shelled foods before cooking.

■ Testing if Cooked

Microwaves cook food quickly, so test food for doneness frequently. Some foods are left in the microwave until completely cooked, but most foods, including meats and poultry, should be removed from the oven while still slightly undercooked and allowed to finish cooking during standing time. The internal temperature of foods will rise between 5 °F (3°C) and 15 °F (8 °C) during standing time.

■ Defrosting Tips

Remove fish, shellfish, meat, and poultry from their original wrapping paper or plastic package. Otherwise, the wrap close to the food will hold steam and heat, which can cause the outer surface of the food to be cooked.

Remove any metal twist ties.

Always slit or pierce plastic pouches or packaging.

Open containers such as cartons before they are placed in the oven.

If food is foil wrapped, remove the foil and place the food in a suitable container.

The length of defrosting time varies depending on the shape of the food and on how solidly the food is frozen.

As food begins to defrost, separate the food into pieces so that they can defrost more easily.

Turn over food during defrosting or standing time. Separate into pieces and remove food as required.

Let food stand after defrosting. Food should still be somewhat icy in the center when removed from the oven.

When using Defrost, the weight to be entered is the net weight in pounds and tenths of pounds (the weight of the food minus the container).

Shielding: Cover the corners of square dishes with small strips of aluminum foil to prevent overcooking. Don't use too much foil, and secure the foil to the dish. Foil can cause arcing if it gets too close to the oven walls during cooking.

Bones and Fat: Bones conduct heat, and fat cooks more quickly than meat. Take care with bony or fatty cuts of meat.

■ Undercooked Food

Covering: Cover food with a microwave-safe lid, parchment paper (not waxed paper), or plastic wrap to trap heat and steam and cook food more quickly.

Standing Time: Let food stand for several minutes after it is removed from the oven to allow it to finish cooking and help flavors blend and develop.

Quantity: The more food you place in the oven, the longer the required cooking time.

Temperature: Ice-cold ingredients take much longer to cook than room temperature ingredients.

Upper Oven

COOKING TIPS (Cont.)

■ Unevenly Cooked Food

Stirring: Stir food from the outside toward the center during cooking, as food at the outside of the dish heats more quickly.

Arranging: Turn food over several times during cooking. The upper portions of thick foods cook more quickly than the lower portions. Thick or dense foods can be elevated so that microwaves can be absorbed by the underside and center of the foods.

Shaping: Place the thickest portions of foods like meat, poultry or fish toward the outside of the cookware to help them cook more evenly. If possible, shape foods into thin rounds or rings.

■ Foods with Skin, Shell or Membrane

Skin or Membrane: Pierce the outsides of foods like potatoes, sausages, or egg whites or yolks before cooking.

Shell: Pierce or remove the shells from eggs, clams, oysters, or other shelled foods before cooking.

■ Testing if Cooked

Microwaves cook food quickly, so test food for doneness frequently. Some foods are left in the microwave until completely cooked, but most foods, including meats and poultry, should be removed from the oven while still slightly undercooked and allowed to finish cooking during standing time. The internal temperature of foods will rise between 5 °F (3 °C) and 15 °F (8 °C) during standing time.

■ Defrosting Tips

Remove fish, shellfish, meat, and poultry from their original wrapping paper or plastic package. Otherwise, the wrap close to the food will hold steam and heat, which can cause the outer surface of the food to be cooked.

Remove any metal twist ties.

Always slit or pierce plastic pouches or packaging.

Open containers such as cartons before they are placed in the oven.

If food is foil wrapped, remove the foil and place the food in a suitable container.

The length of defrosting time varies depending on the shape of the food and on how solidly the food is frozen.

As food begins to defrost, separate the food into pieces so that they can defrost more easily.

Turn over food during defrosting or standing time. Separate into pieces and remove food as required.

Let food stand after defrosting. Food should still be somewhat icy in the center when removed from the oven.

When using Defrost, the weight to be entered is the net weight in pounds and tenths of pounds (the weight of the food minus the container).

Slit the skins of frozen food such as sausage.

Bend plastic pouches of food to ensure even defrosting.

Place food in a shallow container or in a microwave roasting dish to catch the drippings.

Always underestimate defrosting time. Food should still be somewhat icy in the center when removed from the oven. If defrosted food is still frozen solid in the center, return it to the upper oven for more defrosting.

Depending on the shape of the food, some areas may defrost more quickly than others.

The shape of the package affects how quickly food will defrost. Shallow packages will defrost more quickly than a deep block.

For best results, shape ground meat into the form of a doughnut before freezing. When defrosting, scrape off thawed meat when the beep sounds and continue defrosting.

Use small pieces of aluminum foil to shield parts of food such as chicken wings, leg tips, fish tails, or areas that start to get warm. Make sure the foil does not touch the sides, top, or bottom of the oven. The foil can damage the oven lining.

Upper Oven

MICROWAVE POWER LEVELS

This microwave oven is equipped with 10 power levels to give you maximum flexibility and control over cooking.

Power Level	Use
10 (100%)	<ul style="list-style-type: none"> • Boiling water • Browning ground beef • Making candy • Cooking whole poultry, poultry pieces, fish & vegetables • Cooking tender cuts of meat
9 (90%)	<ul style="list-style-type: none"> • Reheating rice, pasta & vegetables
8 (80%)	<ul style="list-style-type: none"> • Reheating prepared foods quickly • Reheating sandwiches
7 (70%)	<ul style="list-style-type: none"> • Cooking egg, milk and cheese dishes • Melting chocolate
6 (60%)	<ul style="list-style-type: none"> • Cooking veal • Cooking whole fish • Cooking puddings and custard
5 (50%)	<ul style="list-style-type: none"> • Cooking ham, whole poultry and lamb • Cooking rib roast and sirloin tip
4 (40%)	<ul style="list-style-type: none"> • Thawing meat, poultry and seafood
3 (30%)	<ul style="list-style-type: none"> • Cooking less tender cuts of meat • Cooking pork chops and roasts.
2 (20%)	<ul style="list-style-type: none"> • Taking chill out of fruit • Softening butter
1 (10%)	<ul style="list-style-type: none"> • Keeping casseroles and main dishes warm • Softening butter and cream cheese

MICROWAVE MODE

Cooking at High Power Level

1. Touch **Microwave** in the cooking mode screen.
2. Touch numbers to set the cook time.
3. Touch **Start** to start cooking.
 - When the cook time is over a melody sounds.

Cooking at Lower Power Levels

High power cooking does not always give the best results with foods that need slower cooking, such as roasts, baked goods, or custards. The oven has 9 power settings in addition to HIGH.

1. Touch **Microwave** in the cooking mode screen.
2. Set the cook time in the display.
3. Set the power level in the display.
4. Touch **Start** to start cooking.
 - When the cook time is over a melody sounds.

To Stop Cooking

Touch **Stop** in the display and select **Yes**.

Upper Oven

CONVECTION BAKE MODE

During Convection Bake, a heating element is used to raise the temperature of the air inside the oven. The convection cooking temperature ranges from 100°F (37°C) to 450°F (230°C). It is best to preheat the oven when convection cooking.

NOTE: Reduce oven temperature by 25°F from the temperature recommended on packaged foods. The baking time may vary according to the food condition or individual preference.

Setting the Convection Bake Function

1. Touch **Convection Bake** in the cooking mode screen.
2. Set the temperature. Scroll through the numbers on the display, or touch the number pad icon to enter the numbers directly.
3. If desired, set the cook time.
4. Touch **Start**. The oven starts to preheat.
5. If the cook time is set, the remaining time appears in the display.
6. A chime sounds once preheating is complete.
7. A chime sounds at the end of the set cook time and a notification appears in the display. Open the oven door and remove the food.

Changing the Convection Bake Settings

1. Touch **Edit** in the display to bring up the Cook Settings screen.
2. Adjust the settings.
3. Touch **Start**.

To Stop Cooking

Touch **Stop** in the display and select **Yes**.

NOTE:

- When the oven reaches the set preheat temperature, a melody will sound. The oven automatically holds that temperature for 30 minutes.
- The oven temperature drops very quickly when the door is opened; however, this should not prevent food from being fully cooked during normal cooking time.

BROIL MODE

This feature will allow you to brown and crisp food quickly. There is no need for preheating.

Setting the Broil Function

1. Touch **Broil** in the cooking mode screen.
2. Set the cook time in the display.
3. Touch **Start**. The oven begins to heat.

Changing the Broil Settings

1. Touch **Edit** in the display to bring up the Cook Settings screen.
2. Adjust the settings.
3. Touch **Start**.

To Stop Cooking

Touch **Stop** in the display and select **Yes**.

NOTE: For best results, use the rack when broiling in the upper oven.

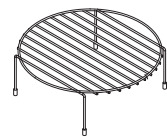

Upper Oven

POPCORN MODE

Prepare microwave popcorn simply and easily, one bag at a time.

- Place one bag only (50 - 100g) of prepackaged microwave popcorn on a microwave-safe / oven-safe dish on the turntable. The package should be at room temperature.

Setting the Popcorn Function

1. Touch **Popcorn** in the cooking mode screen.
2. Touch **Start**. The Popcorn function starts.

To Stop Cooking

Touch **Stop** in the display and select **Yes**.

NOTE:

- When popping prepackaged popcorn, place the bag carefully in the oven so it does not touch the walls as it rotates. Fold the ends of the bag up and toward the center of the bag.
- If popcorn bag size is not known, follow manufacturer's instructions and do not use this feature.
- Do not attempt to reheat or cook any unpopped kernels.
- Do not reuse bag. Overcooking can result in an oven fire.
- Prepare only one bag at a time.
- Do not use popcorn popping devices in microwave oven with this feature.
- Do not leave microwave unattended while cooking popcorn.

DEFROST MODE

The oven has 4 preset defrost modes. The Defrost Menu shows the suggested defrost mode for various foods. This defrost function conveniently chimes during the mode to remind you to check, turn over, separate, or rearrange the food.

- **1:** Meat mode
- **2:** Poultry mode
- **3:** Fish mode
- **4:** Bread mode

Setting the Defrost Function

1. Touch **Defrost** in the cooking mode screen.
2. Set the type of food in the display.
3. Set the weight in the display.
4. Touch **Start** to start defrosting.

To Stop Cooking

Touch **Stop** in the display, and select **Yes**.

NOTE

- The countdown appears in the display after **Start** is pressed. The oven chimes twice during the defrost cycle.
- At the chime, open the oven door and turn the food over. Remove any food that has thawed. Return the still frozen items to the oven and press **Start** to complete the defrost cycle.

Weight Conversion Table

Most food weights are given in pounds and ounces. If using pounds, food weights must be entered into Auto Defrost in pounds and tenths of pounds (decimals).

Use the following table if necessary to convert food weights to decimals.

Ounces	Decimal Weight
1.6	0.1
3.2	0.2
4.8	0.3
6.4	0.4
8.0	0.5 (One-half pound)
9.6	0.6
11.2	0.7
12.8	0.8
14.4	0.9
16.0	1.0 (One pound)

Upper Oven

DEFROST MODE (Cont.)

Defrost Menu

Refer to the information below to set the desired code and weight.

Meat (0.1 - 6.0 lbs)

- Beef: Ground beef, round steak, stew cubes, tenderloin steak, pot roast, rib roast, rump roast, chuck roast, hamburger patties
- Lamb: Chops, rolled roast
- Pork: Chops, hot dogs, spareribs, country-style ribs, rolled roast, sausage
- Veal: Cutlets (1 lb., ½ inch thick)
- Turn food over at beep.
- Standing time: 5-15 minutes

Poultry (0.1 - 6.0 lbs)

- Poultry: Whole, cut-up, breast (boneless)
- Cornish Hens: Whole
- Turkey: Breast
- Rinse chicken with tap water and let stand for 60 minutes after defrosting for better results.
- Turn food over at beep.
- Standing time: 60 minutes

Fish (0.1 - 4.0 lbs)

- Fish: Fillets, whole steaks
- Shellfish: Crab meat, lobster tails, shrimp, scallops
- Turn food over at beep.
- Standing time: 5-10 minutes

Bread (0.1 - 2.0 lbs)

- Sliced bread, buns, baguettes, etc.
- Separate slices and place between paper towels or on flat plate.
- Turn food over at beep.
- Standing time: 1-2 minutes

SPEED COOK MODE

This feature uses power from a halogen light, heaters, and microwaves simultaneously to allow quick cooking.

NOTE

- Power levels only can be selected from 1 to 4 (10% to 40%). Each power level gives you heater power and microwave energy for a certain percentage of the time.

Setting the Speed Convection Function

Use this mode for roast meat, roast chicken, roast vegetables, frozen pizza, cake, pies and breads.

1. Touch **Speed Cook** and **Speed Convection** in that order.
2. Set the **power** level in the display.
3. Set the temperature. Scroll through the numbers on the display, or touch the **number** pad icon to enter the numbers directly.
4. Set the cook time. Touch the arrow key on the right side of the display to set the cook time.
5. Touch **Start**. The oven begins to heat.

Setting the Speed Broil Function

Use this mode for steaks, chicken fillets, fish or seafood.

1. Touch **Speed Cook** and **Speed Broil** in that order.
2. Set the power level and cook time in the display.
3. Touch **Start**. The oven begins to heat.

Upper Oven

SPEED COOK MODE (Cont.)

Changing the Speed Cook Settings

1. Touch **Edit** in the display to bring up the Cook Settings screen.
2. Adjust the settings.
3. Touch **Start**.

To Stop Cooking

Touch **Stop** in the display and select **Yes**.

SENSOR COOK MODE

Use Sensor Cook to heat common microwave-prepared foods without needing to program times and power levels. Sensor Cook has preset programs for 9 food categories. See the Sensor Cook Menu for more information.

About Features

This function reheats favorite foods without selecting cooking times and power levels. The oven automatically determines required cooking time for each food item. When the internal sensor detects a certain amount of humidity coming from the food, it tells the oven how much longer to heat.

The display shows the remaining heating time. For best results when sensor cooking, follow these recommendations.

- Food cooked with the sensor system should be at normal storage temperature.
- The glass tray and the outside of the container should be dry to assure best cooking results.
- Foods should always be covered loosely with microwavable plastic wrap, waxed paper, or a lid.
- Do not open the door during the sensing time. When sensing time is over, the oven beeps and the remaining cooking time will appear in the display window. At this time you can open the door to stir, turn, or rearrange the food.

Appropriate containers and coverings help assure good sensor cooking results.

- Always use microwavable containers and cover them with lids or vented plastic wrap.

- Never use tight-sealing plastic covers. They can prevent steam from escaping and cause food to overcook.
- Match the amount to the size of the container. Fill containers at least half full for best results.
- Be sure the outside of the cooking container and the inside of the upper oven are dry before placing food in the oven. Beads of moisture turning into steam can mislead the sensor.
- Do not use Sensor Features twice in succession on the same food portion. If food is undercooked after the first countdown, use COOK BY TIME for additional cooking time.

Setting the Sensor Cook Function

1. Touch **Sensor Cook** in the cooking mode screen.
2. Touch a category to filter the options.
3. Touch **Start**.
When the cook time is over a melody sounds.

To Stop Cooking

Touch **Stop** in the display and select **Yes**.

Sensor Cook Menu

Refer to the information below to set the desired menu item and see the recommended amounts.

- **1. Beverage (1 - 2 cups[†])**
 - **Cookware:** Mug or microwave-safe cup on the glass tray
 - **Food temperature:** Room
 - **Instructions:** Use microwave safe mug or cup without covering. After cooking, stir to complete reheating.
- **2. Casserole (10-20 oz)**
 - **Cookware:** Microwave-safe bowl on the glass tray
 - **Food temperature:** Refrigerated
 - **Instructions:** Use microwave safe bowl. Cover container with vented plastic wrap. After cooking, let stand for 3 minutes.

Upper Oven

SENSOR COOK MODE (Cont.)

- **3. Chicken** (16-20 oz)
 - **Cookware:** Microwave-safe bowl on the glass tray
 - **Food temperature:** Refrigerated
 - **Instructions:** Use microwave safe bowl. Cover container with vented plastic wrap. After cooking, let stand for 3 minutes.

- **4. Pasta** (½-2 cups†)
 - **Cookware:** Microwave-safe bowl on the glass tray
 - **Food temperature:** Refrigerated (precooked)
 - **Instructions:** Use microwave safe bowl. Cover container with vented plastic wrap. After cooking, let stand for 3 minutes.

- **5. Pizza** (1-3 slices)
 - **Cookware:** Microwave-safe dish on the glass tray
 - **Food temperature:** Refrigerated
 - **Instructions:** This is a reheat function for leftover pizza. Use microwave safe plate without covering.

- **6. Plate of Food** (1 serving)
 - **Cookware:** Microwave-safe dish on the glass tray
 - **Food temperature:** Refrigerated
 - **Instructions:** Use microwave safe plate. Cover container with vented plastic wrap. After cooking, let stand for 3 minutes.

- **7. Rice** (½-2 cups†)
 - **Cookware:** Microwave-safe bowl on the glass tray
 - **Food temperature:** Refrigerated (precooked)
 - **Instructions:** Use microwave safe bowl. Cover container with vented plastic wrap. After cooking, let stand for 3 minutes.

- **8. Soup** (1-4 cups†)
 - **Cookware:** Microwave-safe bowl on the glass tray
 - **Food temperature:** Room
 - **Instructions:** Use microwave safe bowl. Cover container with vented plastic wrap. After cooking, let stand for 3 minutes.

- **9. Vegetable** (1-4 cups†)
 - **Cookware:** Microwave-safe bowl on the glass tray
 - **Food temperature:** Refrigerated
 - **Instructions:** Use microwave safe bowl. Cover container with vented plastic wrap. After cooking, let stand for 3 minutes.

† 8 oz (240 ml) per cup

MICROWAVE QUICK START MODE

Use this to quickly add 30 seconds to microwave cooking time.

To use, touch the **Microwave Quick Start** icon at the bottom left side of the screen.

Upper Oven

PRECISION COOK MODE

Use this function to heat common prepared foods without selecting cooking times and power levels.

This function has preset programs for 28 food items.

Setting the Precision Cook Mode

1. Touch **Precision Cook** in the cooking mode screen.
2. Touch a desired menu in the display.
3. Scroll through or tap the arrow key to select recommended amounts. Touch **Next**.
4. Follow the recommendations in the display regarding accessories.
5. Touch **Start**.

Precision Cook Menu

Refer to the information below to set the desired menu item and see the recommended amounts.

- **1. Bacon (3-4 or 5-6 slices)**

 - **Cookware:** Microwave-safe bacon rack or plate on the glass tray
 - **Food temperature:** Refrigerated
 - **Instructions:** Place bacon slices on a microwave rack for best results. Use a plate lined with paper towels if rack is not available.
- **2. Frozen Bagels (1 or 2-3 bagels)**

 - **Cookware:** Metal tray
 - **Food temperature:** Frozen
- **3. Baked Potatoes (1, 2, 3-4 potatoes (7-9 oz/ea))**

 - **Cookware:** Metal tray
 - **Food temperature:** Room
 - **Instructions:** Pierce each potato several times with a fork.
- **4. Brownies (8" X 8", 9" X 13")**

 - **Cookware:** Microwave-safe bowl on the glass tray
 - **Food temperature:** Room
 - **Instructions:** Spray microwave-safe glass or silicone bakeware with cooking spray. Pour batter into bakeware, spreading it evenly. After cooking, allow to rest for a few minutes.
- **5. Cod Fillets (1 lb)**

 - **Cookware:** Metal tray
 - **Food temperature:** Refrigerated
 - **Instructions:** Brush with oil and season with salt and pepper. Turn food over at the beep.
- **6. Frozen Corn Dog (1-2, 3-4)**

 - **Cookware:** Metal tray
 - **Food temperature:** Frozen
- **7. Fresh Vegetable (4-6, 7-9, 10-12, 13-15, 16-20 oz)**

 - **Cookware:** Microwave-safe bowl on the glass tray
 - **Food temperature:** Refrigerated
 - **Instructions:** Add water according to the quantity (4-12 oz: add 2 tbsp water, 13-20 oz: add 4 tbsp water). Cover with vented plastic wrap. After cooking, stir and let stand for 3 minutes.
- **8. Frozen Chicken Nuggets (1-2, 3-4 servings (3.5 oz / 100 g per serving))**

 - **Cookware:** Metal tray
 - **Food temperature:** Frozen
 - **Instructions:** Turn food over at the beep.
- **9. Frozen Chicken Wings (1-2, 3-4 servings (3.5 oz / 100 g per serving))**

 - **Cookware:** Metal tray
 - **Food temperature:** Frozen
 - **Instructions:** Turn food over at the beep.
- **10. Frozen Fries (1-2, 3-4 servings (3.5 oz / 100 g per serving))**

 - **Cookware:** Metal tray
 - **Food temperature:** Frozen
 - **Instructions:** Turn food over at the beep.

Upper Oven

PRECISION COOK MODE (Cont.)

Precision Cook Menu (Cont.)

- **11. Frozen Pizza** (Individual: 6", Regular: 12")
 - **Cookware:** Metal tray
 - **Food temperature:** Frozen
- **12. Frozen Pretzels (1, 2, 3-4 pretzels)**
 - **Cookware:** Metal tray
 - **Food temperature:** Frozen
- **13. Frozen vegetables** (4-6, 7-9, 10-12, 13-15, 16-20 oz)
 - **Cookware:** Microwave-safe bowl on the glass tray
 - **Food temperature:** Frozen
 - **Instructions:** Add water according to the quantity (4-12 oz: add 2 tbsp water, 13-20 oz: add 4 tbsp water). Cover with vented plastic wrap. After cooking, stir and let stand for 3 minutes.
- **14. Frozen Garlic Bread** (1-2, 3-4, 5-6 pieces)
 - **Cookware:** Metal tray
 - **Food temperature:** Frozen
 - **Instructions:** Turn food over at the beep.
- **15. Hamburger, 1/2" thick** (2, 3-4, 5-6 patties)
 - **Cookware:** Metal tray
 - **Food temperature:** Refrigerated
 - **Instructions:** Turn food over at the beep.
- **16. Lamb Chops, 1/2" thick** (6-7 oz) (1, 2, 3-4 chops)
 - **Cookware:** Metal tray
 - **Food temperature:** Refrigerated
 - **Instructions:** Brush with oil and season with salt and pepper. Turn food over at the beep.
- **17. Meat Loaf (9" X 5")**
 - **Cookware:** Microwave-safe glass or silicone bakeware on the glass tray
 - **Food temperature:** Refrigerated
 - **Ingredients:**
Ground meat: 28 oz / 800 g, Egg (refrigerated: 4 oz / 115 g, Salt: 1/2 tsp / 2 g)
 - **Instructions:** Place meat mixture into microwave-safe 9" x 5" glass or silicone bakeware.
- **18. Nachos** (1-3, 4-6 servings (8 ea / 1 serving))
 - **Cookware:** Metal tray
 - **Food temperature:** Room
- **19. Oatmeal** (1, 2 servings)
 - **Cookware:** Large microwave-safe bowl on the glass tray
 - **Food temperature:** Room
 - **Ingredients:**
1 Serving: Oats 1/2 cup (40 g), Water or Milk 1 cup (230 g), Salt (Optional) dash
2 Servings: Oats 1 cup (80 g), Water or Milk 1 1/2 cups (345 g), Salt (Optional) 1/8 tsp
 - **Instructions:** Combine water or milk, salt and oats in a large microwave-safe bowl. Cover with vented plastic wrap. After cooking, let stand for 3 minutes.
- **20. Pork Chops, 1/2" thick** (1, 2, 3-4 chops)
 - **Cookware:** Metal tray
 - **Food temperature:** Refrigerated
 - **Instructions:** Brush with oil and season with salt and pepper. Turn food over at the beep.

Upper Oven

PRECISION COOK MODE (Cont.)

Precision Cook Menu (Cont.)

- **21. Quinoa** (1, 2 generous servings)
 - **Cookware:** Microwave-safe bowl on the glass tray
 - **Food temperature:** Room
 - **Ingredients:**
 - 1 Serving: Quinoa 1/2 cup (40 g), Water or Milk
 - 1 cup (230 g), Salt (Optional) dash
 - 2 Servings: Quinoa 1 cup (0 g), Water or Milk 1
 - 1/2 cups (345 g), Salt (Optional) 1/8 tsp
 - **Instructions:** Combine water or milk, salt and quinoa in a large microwave-safe bowl. Cover with vented plastic wrap. After cooking, let stand for 3 minutes.
- **22. Ribeye Steak** (14-15 oz) (1, 2 steaks)
 - **Cookware:** Metal tray
 - **Food temperature:** Refrigerated
 - **Instructions:** Brush with oil and season with salt and pepper. Turn food over at the beep.
- **23. Rice** (1/2, 1 cup)
 - **Cookware:** Deep and large microwave-safe bowl on the glass tray
 - **Food temperature:** Room
 - **Ingredients:**
 - Rice: 1/2 cup (96 g), 1 cup (192 g)
 - Water: 1 cup (230 g), 2 cups (460 g)
 - Salt: Optional
 - **Instructions:** Cover with vented plastic wrap. After cooking, let stand for 5-10 minutes.
- **24. Salmon Steak** (1, 2, 3-4 steaks)
 - **Cookware:** Metal tray
 - **Food temperature:** Refrigerated
 - **Instructions:** Brush with oil and season with salt and pepper. Turn food over at the beep.
- **25. Sausage** (1-6 , 7-14 links)
 - **Cookware:** Metal tray
 - **Food temperature:** Refrigerated
 - **Instructions:** Turn food over at the beep.
- **26. Sirloin Steak** (18-21 oz) (1, 2 steaks)
 - **Cookware:** Metal tray
 - **Food temperature:** Refrigerated
 - **Instructions:** Brush with oil and season with salt and pepper. Turn food over at the beep.
- **27. Tenderloin** (¾ , 1 ½ lb)
 - **Cookware:** Metal tray
 - **Food temperature:** Refrigerated
 - **Instructions:** Brush with oil and season with salt and pepper. Turn food over at the beep.
- **28. Canned Vegetables** (4-6, 7-9, 10-12, 13-15, 16-20 oz)
 - **Cookware:** Microwave-safe bowl on the glass tray
 - **Food temperature:** Room
 - **Instructions:** Transfer canned vegetables to microwave-safe bowl. Cover with vented plastic wrap. After cooking, stir and let stand for 3 minutes.

Upper Oven

SOFTEN MODE

The oven uses low power to soften foods such as butter, cream cheese, frosting, and ice cream. See the following table.

Setting the Soften Mode

1. Touch **Soften** in the cooking mode screen.
2. Set the type of food in the display.
3. Set the weight in the display.
4. Touch **Start**.
5. When the cook time is over a melody sounds.

To Stop Cooking

Touch **Stop** in the display and select **Yes**.

Soften Table

- **1. Butter** (½, 1, 2 sticks)
 - **Cookware:** Microwave-safe dish on the glass tray
 - **Food temperature:** Refrigerated
 - **Instructions:** Butter will be at room temperature and ready for use in a recipe.
- **2. Cream cheese** (3, 8 oz)
 - **Cookware:** Microwave-safe dish on the glass tray
 - **Food temperature:** Refrigerated
 - **Instructions:** Cream cheese will be at room temperature and ready for use in a recipe.
- **3. Frosting** (16 oz)
 - **Cookware:** Microwave-safe bowl on the glass tray
 - **Food temperature:** Refrigerated
 - **Instructions:** Frosting will be at room temperature and ready for use in a recipe.

- **4. Ice cream** (1 pint, 1 quart)

- **Cookware:** Glass tray
- **Food temperature:** Frozen
- **Instructions:** Remove lid and cover. Ice cream will be soft enough to make scooping easier.

MELT MODE

The oven uses low power to melt foods such as butter, caramel, cheese, chocolate, and marshmallows. See the following table.

Setting the Melt Mode

1. Touch **Melt** in the cooking mode screen.
2. Set the type of food in the display.
3. Set the weight in the display.
4. Touch **Start**.

When the cook time is over a melody sounds.

To Stop Cooking

Touch **Stop** in the display and select **Yes**.

Melt Table

- **1. Butter** (½, 1, 2 sticks)
 - **Cookware:** Microwave-safe bowl on the glass tray
 - **Food temperature:** Refrigerated
 - **Instructions:** After cooking, stir to complete melting.
- **2. Caramel** (4, 8, 12 oz)
 - **Cookware:** Microwave-safe bowl on the glass tray
 - **Food temperature:** Room
 - **Instructions:** After cooking, stir to complete melting.

Upper Oven

MELT MODE (Cont.)

Melt Table (Cont.)

- **3. Cheese** (4, 8, 12 oz)
 - **Cookware:** Microwave-safe bowl on the glass tray
 - **Food temperature:** Refrigerated
 - **Instructions:** Use processed cheese food only. Cut into cubes. After cooking, stir to complete melting.
- **4. Chocolate** (4, 8, 12 oz)
 - **Cookware:** Microwave-safe bowl on the glass tray
 - **Food temperature:** Room
 - **Instructions:** Chocolate chips or squares of baking chocolate may be used. After cooking, stir to complete melting.
- **5. Marshmallow** (5, 10 oz)
 - **Cookware:** Microwave-safe bowl on the glass tray
 - **Food temperature:** Room
 - **Instructions:** After cooking, stir to complete melting.

WARM MODE

This function maintains an oven temperature of less than 230°F. This function should not be used to reheat cold food. This function keeps cooked food warm for serving up to 3 hours after cooking has finished. After 3 hours this function shuts the oven OFF automatically.

Setting the Warm Mode

1. Touch **Warm** in the cooking mode screen.
2. Select the temperature level: **Low**, **Medium**, or **High**.
 - Low: 140°F - 160°F (60°C- 71°C)
 - Medium: 160°F - 195°F (71°C- 91°C)
 - High: 195°F - 230°F (91 °C- 110°C)
3. Select the type: **moist**, **crisp**.
4. Touch **Start** to start warming.

To Stop Cooking

Touch **Stop** in the display and select **Yes**.

NOTE:

- This function is intended to keep food warm. Do not use it to cool food down.
- It is normal for the fan to operate during this function.

PROOF MODE

This function maintains a warm oven for rising yeast-leavened products before baking.

Setting the Proof Mode

1. Touch **Proof** in the cooking mode screen.
2. Touch **Start** to start proofing.

To Stop Cooking

Touch **Stop** in the display and select **Yes**.

NOTE

- To avoid lowering the oven temperature and lengthening proofing time, do not open the oven door unnecessarily.
- Check bread products early to avoid over-proofing.
- Do not use the Proofing mode for warming food or keeping food hot. The proofing oven temperature is not hot enough to hold foods at safe temperatures. Use the Warm function to keep food warm.
- Proofing will not operate if the oven is too hot. Allow the oven to cool before proofing.

Lower Oven

BEFORE USING THE LOWER OVEN

- Because the oven temperature cycles, an oven thermometer placed in the oven cavity may not show the same temperature that is set on the oven.
- It is normal for the convection fan to run while preheating during a regular bake cycle.
- The convection fan motor may run periodically during a regular bake cycle.
- The heat turns off if the door is left open during baking. If the door is left open for longer than 30 seconds during baking, the heat turns off. The heat turns back on automatically once the door is closed.
- Avoid opening the oven door more than necessary during use. This helps the oven maintain temperature, prevents unnecessary heat loss, and saves on energy use.

Oven Vent

Areas near the vent may become hot during operation and may cause burns. Avoid placing plastics near the vent as heat may distort or melt the plastic.

It is normal for steam to be visible when cooking foods with high moisture content.

⚠ CAUTION

Do not use any type of foil or oven liner to cover the oven bottom. These items can trap heat or melt, resulting in damage to the product and risk of shock, smoke, or fire. Damage from improper use of these items is not covered by the product warranty.

⚠ PRECAUCIÓN

No use ningún tipo de papel de aluminio ni revestimiento de horno para cubrir la parte inferior del horno. Estos ítems podrán atrapar el calor o derretirse, ocasionando daños sobre el producto y el riesgo de descarga, humo o incendio. Los daños por uso inadecuado de estos ítems no están cubiertos por la garantía del producto.

USING STANDARD OVEN RACKS

⚠ CAUTION

Use caution with removing a rack from the lowest position as door may be hot.

⚠ PRECAUCIÓN

Tenga cuidado al retirar una parrilla desde la posición más baja, ya que la puerta podrá estar caliente.

The racks have a turned-up back edge that prevents them from being pulled out of the oven cavity.

Removing Racks

1. Pull the rack straight out until it stops.
2. Lift up the front of the rack and pull it out.

Replacing Racks

1. Place the end of the rack on the support.
2. Tilt the front end up and push the rack in.

USING EXTENSION RACKS

The gliding racks slide in and out on a frame. This keeps heavy cookware level and prevents it from sliding forward when the rack is completely extended.

Installing Extension Racks

1. Start with the rack in the closed position. Hold the rack with one hand at the center front and the other hand at the back right corner.
2. Carefully insert the rack between the rack guides, and slide it back until the shelf drops into place.

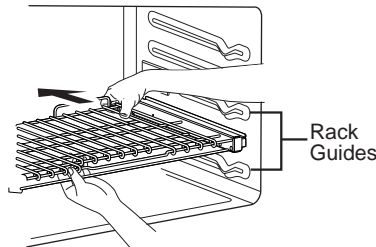

3. Once the rack is secured in the back, pull the entire rack forward until the rack locks into place.

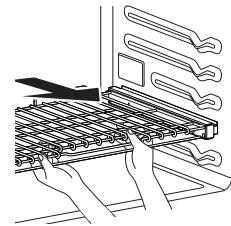

Removing Extension Racks

1. With the rack in the closed position, grasp the front of the rack and frame and lift up. Slowly push the rack towards the back wall until it is free of the rack stop.
2. After disengaging the rack stop, lift the back of the rack and pull the rack and frame out between the rack guides.

Lower Oven

CONVECTION BAKE AND ROAST MODE

The convection system uses a fan to circulate the heat evenly within the oven. Improved heat distribution allows for even cooking and excellent results while cooking with single or multiple racks.

The oven can be programmed to bake at any temperature from 170°F (80°C) to 550°F (285°C). The default temperature is 350°F(175°C).

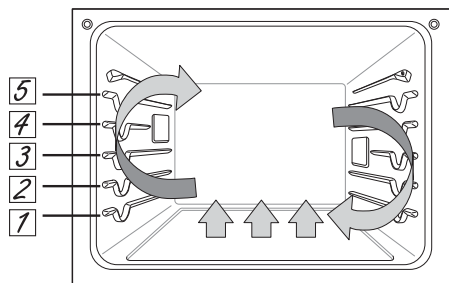

Using Convection

1. Touch **Convection Bake** or **Convection Roast** in the cooking mode screen.
2. Set the temperature. Scroll through the numbers on the display or touch the number pad icon to enter the numbers directly.
3. If desired, set the cook time and delayed start time using the same method. Touch the **arrow key** on the right side of the display to see the delayed start time settings.
4. Touch **Start**. The oven starts to preheat.
5. If the cook time is set, the remaining time appears in the display. If a delayed start time is set, the start time appears in the display.
6. A chime sounds once preheating is complete.
7. A chime sounds at the end of the set cook time and a notification appears in the display. Open the oven door and remove the food.

NOTE

- If no cook time is set, the oven turns off automatically after 12 hours.

- The heating elements and fan turn off immediately when the door is opened. They turn on again approximately 1 second after the door is closed.
- Touch **Stop** in the display to cancel Convection Bake and Convection Roast at any time.
- When preparing meats for roasting, use the broiler pan and grid. The broiler pan catches grease spills and the grid helps prevent grease splatters.
- The oven fan runs while convection baking and convection roasting. The fan stops when the door is opened. In some cases, the fan may shut off during a convection bake cycle.

Changing the Cook Settings

- 1 Touch **Edit** in the display to bring up the Cook Settings screen.
- 2 Adjust the settings using the number pad or scroll function.
- 3 Touch **Start**.

To Stop Cooking

Touch **Stop** in the display, and select **Yes**.

Tips for Convection Baking

- Use Convection Bake for faster and more even multiple-rack cooking of pastries, cookies, muffins, biscuits, and breads of all kinds.
- Bake cookies and biscuits on pans with no sides or very low sides to allow heated air to circulate around the food. Food baked on pans with a dark finish will cook faster.
- When using Convection Bake with a single rack, place oven rack in position 3. If cooking on multiple racks, place the oven racks in positions 2 and 4.
- Multiple oven rack cooking may slightly increase cook times for some foods.
- Cakes, cookies and muffins have better results when using multiple racks.

Lower Oven

CONVECTION BAKE AND ROAST MODE (Cont.)

The Convection Roast feature is designed to give optimum roasting performance. Convection Roast combines cooking with the convection fan to roast meats and poultry. The heated air circulates around the food from all sides, sealing in juices and flavors. Foods are crispy brown on the outside while staying moist on the inside. Convection roasting is especially good for large tender cuts of meat, uncovered.

Tips for Convection Roasting

Use a broiler pan and grid when preparing meats for convection roasting. The broiler pan catches grease spills and the grid helps prevent grease splatters.

1. Place the oven rack in position 1 or 2.
2. Place the grid in the broiler pan.
3. Place the broiler pan on the oven rack.

BAKE MODE

Bake is used to prepare foods such as pastries, breads and casseroles.

The oven can be programmed to bake at any temperature from 170°F (80°C) to 550°F (285°C). The default temperature is 350°F (175°C).

Setting the Bake Function

1. Touch **Bake** in the cooking mode screen.
2. Set the oven temperature. Scroll through the numbers on the display or touch the number pad icon to enter the numbers directly.
3. If desired, set the cook time and delayed start time using the same method. Touch the **arrow key** on the right side of the display to see the delayed start time settings.
4. Touch **Start**. The oven starts to preheat.
5. If the cook time is set, the remaining time appears in the display. If a delayed start time is set, the start time appears in the display.
6. A chime sounds once preheating is complete.

7. A chime sounds at the end of the set cook time and a notification appears in the display. Open the oven door and remove the food.

NOTE: If no cook time is set, the oven turns off automatically after 12 hours.

Changing the Cook Settings

1. Touch **Edit** in the display to bring up the Cook Settings screen.
2. Adjust the settings using the number pad or scroll function.
3. Touch **Start**.

To Stop Cooking

Touch **Stop** in the display, and select **Yes**.

NOTE

- It is normal for the convection fan to operate periodically throughout a normal bake cycle in the oven. This is to ensure even baking results.

Baking Tips

- For best results, food should be placed on a single rack with at least 1" to 1 1/2" of air space between the pans and oven walls.
- Baking time and temperature will vary depending on the characteristics, size, and shape of the baking pan used.
- Check for food doneness at the minimum recipe time.
- Use metal bakeware (with or without a nonstick finish), heatproof glass-ceramic, ceramic or other bakeware recommended for oven use.
- Dark metal pans or nonstick coatings will cook food faster with more browning. Insulated bakeware will slightly lengthen the cooking time for most foods.
- The oven bottom has a porcelain-enamel finish. To make cleaning easier, protect the oven bottom from excessive spillovers by placing a cookie sheet on the rack below the rack you are cooking on. This is particularly important when baking a fruit pie or other foods with a high acid content. Hot fruit fillings or other foods that are highly acidic may cause pitting and damage to the porcelain-enamel surface and should be wiped up immediately.

Lower Oven

RECOMMENDED BAKING GUIDE

Rack and Pan Placement

Baking results will be better if baking pans are centered in the oven as much as possible. If cooking on multiple racks, place the oven racks in the positions shown.

Multiple-rack cooking saves time and energy. Whenever possible, cook foods requiring the same cooking temperature together in one oven.

If baking with more than one pan, place the pans so that each one has at least 1" to 1 1/2" of air space around them.

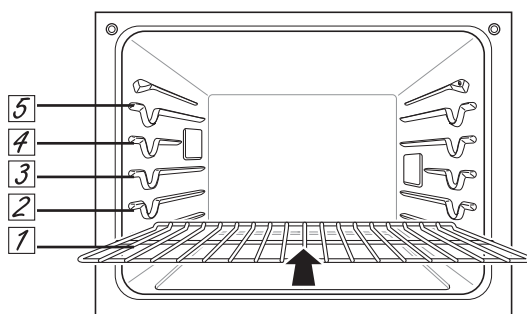

Multiple Rack

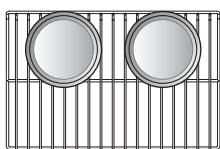

Extension Rack
Position 2

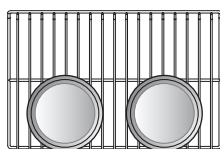

Extension Rack
Position 4

Single Rack

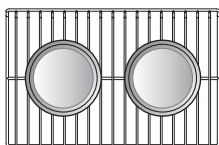

Single Rack Baking Rack Guide

Type of Food	Rack Position
Angel food cake, frozen pies	3
Bundt or pound cakes	2
Biscuits, muffins, brownies, cookies, cupcakes, layer cakes, pies	3
Casseroles	2
Turkey, roasts, or ham	1
Frozen pizza	3
Roast chicken	2

NOTE: When baking cakes and cookies on multiple racks, use the Convection Bake mode and place racks in positions 2 and 4.

Cook food thoroughly to help protect against foodborne illness. Minimum safe food temperature recommendations for food safety can be found at food.safety.gov. Make sure to use a food thermometer to take food temperatures.

BROIL MODE

Setting the Oven to Broil

Broiling uses an intense, radiant heat to cook food. Both the inner and outer broil elements heat during full broiling. Only the inner broil element heats during center broiling. The element(s) cycle on and off at intervals to maintain the oven temperature. The meat probe cannot be used with this mode.

Keep the oven door closed while broiling. Let the oven preheat for approximately 5 minutes before cooking food.

Lower Oven

BROIL MODE (Cont.)

NOTE

- This appliance is designed for closed-door broiling. Close the door to set the Broil function. If the door is open, the Broil function cannot be set and **DOOR OPEN** appears on the display. Close the door and reset the Broil function. If the door is opened during broiling, the broil burner turns off after five seconds. The broiler turns back on automatically once the door is closed.

1. Place the food on the broiler pan grid.
2. Touch **Broil** in the cooking mode screen.
3. Scroll to set the desired temperature: **Low, Medium, or High**. If desired, scroll to set a cook time.
4. If desired, set the cook time and delayed start time using the same method. Touch the arrow key on the right side of the display to see the delayed start time settings.
5. Touch **Start**. The oven door must be closed to use the Broil function.
6. Let the oven preheat for approximately 5 minutes before cooking the food.
7. If the cook time is set, the remaining time appears in the display. If a delayed start time is set, the start time appears in the display.
8. Touch **Stop** to cancel at any time or when cooking is complete.

NOTE

- If the cook time is not set, the oven automatically turns off after 3 hours.
- The heating element(s) turn off after 5 seconds when the door is opened. They turn on again immediately when the door is closed.
- Touch **Stop** in the display to cancel Broil at any time.

Changing the Broil Settings

1. Touch **Edit** in the display to bring up the Cook Settings screen.
2. Adjust the settings.
3. Touch **Start**.

To Stop Broiling

Touch **Stop** in the display, and select **Yes**.

Tips for Reducing Smoke

Due to the intense heat associated with broiling, it is normal to experience smoke during the cooking process. This smoke is a natural by-product of searing and should not cause you to worry. If you are experiencing more smoke than you are comfortable with, use the following tips to reduce the amount of smoke in your oven.

- Always use a broiler pan. Do not use saute pans or regular baking sheets for safety reasons.
- The broiler pan should always be thoroughly cleaned and at room temperature at the beginning of cooking.
- Keep the interior of your oven as clean as possible. Leftover debris from prior meals can burn or catch fire.
- Avoid fatty marinades and sugary glazes. Both of these will increase the amount of smoke you experience. If you would like to use a glaze, apply it at the very end of cooking.
- If you are experiencing significant smoke with any food item, consider:
 - Switching the broiler to the LO setting.
 - Lowering the rack position to cook the food farther away from the broiler.
 - Using the HI broil setting to achieve the level of searing you desire, and then either switching to the LO broil setting, or switching to the Bake function.
- As a rule, fattier cuts of meat and fish will produce more smoke than leaner items.
- Adhere to the guidelines in the Recommended Broiling Guide section whenever possible.

Lower Oven

BROIL MODE (Cont.)

Recommended Broiling Guide

The size, weight, thickness, starting temperature, and your preference of doneness will affect broiling times. This guide is based on meats at refrigerator temperature. For best results when broiling, use a pan designed for broiling.

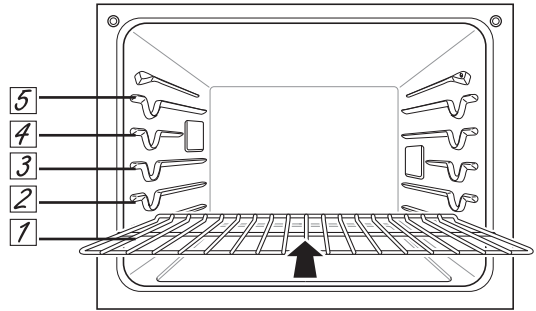
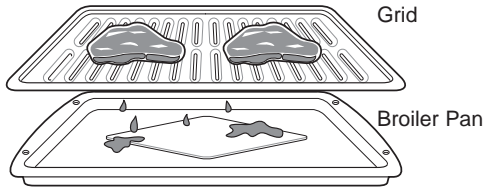

Food	Quantity and/or Thickness	Rack Position	Comments	
Ground Beef	1 lb (9 patties) 1/2 to 3/4" thick	5	Space evenly. Up to 9 patties may be broiled at once.	
Beef Steaks	1" thick 1 to 1-1/2 lbs.	Rare	4	Steaks less than 1" thick cook through before browning. Pan frying is recommended. Slash fat.
		Medium	4	
		Well done	4	
	1-1/2" thick 2 to 2-1/2 lbs	Rare	4	
		Medium	4	
		Well done	4	
Chicken	1 whole, 2 to 2-1/2 lbs., split lengthwise	3	Broil skin-side-down first.	
	2 Breasts	3		
Lobster Tails	2-4 10 to 12 oz each	3	Cut through back of shell. Spread open. Brush with melted butter before broiling and after half of broiling time.	
Fish Fillets	1/4 to 1/2" thick	4 or 5	Handle and turn very carefully. Brush with lemon butter before and during cooking, if desired.	
Ham Slices (precooked)	1/2" thick	4	Increase time 5 to 10 minutes per side for 1-1/2" thick or home-cured ham.	
Pork Chops Well done	2 (1/2" thick)	4 or 5	Slash fat.	
	2 (1" thick) about 1lb.	4 or 5		
Lamb Chops	2 (1" thick) about 10 to 12 oz	Medium	4	Slash fat.
		Well done	4	
	2 (1-1/2" thick) about 1lb	Medium	4	
		Well done	4	
Salmon Steaks	2 (1" thick)	4 or 5	Grease pan. Brush steaks with melted butter.	
	4 (1" thick) about 1 lb	4 or 5		

This guide is only for reference. Adjust rack position according to your preference.

NOTE

- The USDA advises that consuming raw or undercooked fish, meat, or poultry can increase your risk of food-borne illness.
- The USDA has indicated the following as safe minimum internal temperatures for consumption:

- Ground beef: 160°F (71.1°C)
- Poultry: 165°F (73.9°C)
- Beef, veal, pork, or lamb: 145°F (62.8°C)
- Fish / Seafood: 145°F (62.8°C)

Lower Oven

BROIL MODE (Cont.)

Tips for Broiling

Beef

- Steaks and chops should always be allowed to rest for five minutes before being cut into and eaten. This allows the heat to distribute evenly through the food and creates a more tender and juicy result.
- Pieces of meat that are thicker than two inches should be removed from the refrigerator 30 minutes prior to cooking. This will help them cook more quickly and evenly, and will produce less smoke when broiling.
- For bone-in steaks or chops that have been frenched (all meat removed from around the bone), wrap the exposed sections of bone in foil to reduce burning.

Seafood

- When broiling skin-on fish, always use the Lo broil setting and always broil the skin side last.
- Seafood is best consumed immediately after cooking. Allowing seafood to rest after cooking can cause the food to dry out.
- It is a good idea to rub a thin coating of oil on the surface of the broiling pan before cooking to reduce sticking, especially with fish and seafood. You can also use a light coating of non-stick pan spray.

Vegetables

Toss your vegetables lightly in oil before cooking to improve browning.

WARM MODE

This function will maintain an oven temperature of less than 200°F (93.3°C). It will keep cooked food warm for serving up to 3 hours after cooking has finished.

Setting the Warm Mode

1. Touch **Warm** in the cooking mode screen.
2. Scroll to set the desired temperature: Low, Medium, or High. If desired, scroll to set a run time.
 - High: 200°F (93.3°C)
 - Medium: 170°F (76.7°C)
 - Low: 140°F (60°C)

3. If desired, set the warming time and delayed start time using the same method. Touch the **arrow key** on the right side of the display to see the delayed start time settings.

4. Touch **Start**. If the run time was set, the remaining time appears in the display.

Changing the Warm Settings

1. Touch **Edit** in the display to bring up the Cook Settings screen.
2. Adjust the settings as desired.
3. Touch **Start**.

Cancelling the Warm Function

Touch **Stop** in the display, and select **Yes**.

NOTE

- The Warm function is intended to keep food warm. Do not use it to cool food down or to heat cold food.
- If the cook time is not set, the oven automatically turns off after 3 hours.

PROOF MODE

This feature maintains a warm oven for rising yeast-leavened products before baking.

Setting the Proof Mode

1. Touch **Proof** in the cooking mode screen.
2. Read the instruction and touch the **arrow key** on the right side of the display.
3. Scroll through the numbers to set a proofing time or touch the number pad icon to enter the numbers directly.
4. If desired, set the cook time and delayed start time using the same method.
5. Touch **Start**. The remaining proofing time appears in the display.

NOTE: If the proofing time is not set, the oven automatically turns off after 12 hours.

Canceling the Proof Function

Touch **Stop** in the display, and select **Yes**.

NOTE:

- To avoid lowering the oven temperature and lengthening proofing time, do not open the oven door unnecessarily. Check bread products early to avoid over proofing.

Lower Oven

PROOF MODE (Cont.)

- Do not use the Proofing mode for warming food or keeping food hot. The proofing oven temperature is not hot enough to keep foods at safe temperatures. Use the Warm feature to keep food warm. Proofing does not operate when the oven is above 125°F. **OVEN IS HOT** shows in the display.
- It is normal for the fan to operate during the Proof function.
- The proof feature automatically provides the optimum temperature for the proofing process, and therefore does not have a temperature adjustment.
- For best results, cover the dough with a cloth or with plastic wrap. (The plastic may need to be anchored underneath the container so the oven fan does not blow it off.)

AIR FRY

This feature automatically increases the entered temperature by 45°F for optimal performance when using Air Fry.

The Air Fry mode can be programmed to cook at any temperature from 300°F (150°C) to 500°F (260°C). The default temperature is 400°F (205°C).

The Air Fry function is specially designed for oil free frying.

Setting the Air Fry Mode

1. Touch **Air Fry** in the cooking mode screen.
2. Set the oven temperature. Scroll through the numbers on the display or touch the number pad icon to enter the numbers directly.
3. If desired, set the cook time and delayed start time using the same method. Touch the arrow key on the right side of the display to see the delayed start time settings.
4. Touch **Start**.
5. If the cook time is set, the remaining time appears in the display. If a delayed start time is set, the start time appears in the display.

Changing the Cook Settings

1. Touch **Edit** in the display to bring up the Cook Settings screen.
2. Adjust the settings using the number pad or scroll function.
- 3 Touch **Start**.

To Stop Cooking

Touch **Stop** in the display, and select **Yes**.

NOTE:

- No preheating is required when using the Air Fry mode.
- If cooking multiple batches, the later batches may take less time to cook.
- Wet batters and coatings will not crisp or set when using the Air Fry mode.

Tips for Air Fry

- For best results, use the provided air fry tray.

The mesh section of the air fry tray can be cleaned in a dishwasher.

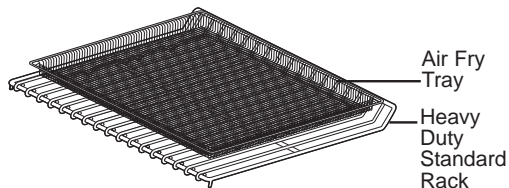

- If you don't have the air fry tray, place food on a wire rack inside a foil-lined broiler pan.

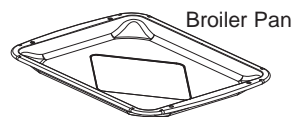

- For best results, cook food on a single rack placed in positions suggested in the chart in this manual.
- Spread the food out evenly in a single layer.
- Use either the optional air fry tray available from GE Appliances or a dark baking tray with no sides or short sides that does not cover the entire rack. This allows for better air circulation.

Lower Oven

AIR FRY(cont.)

- If desired, spray the baking tray or air fry tray with a pan spray. Use an oil that can be heated to a high temperature before smoking, such as avocado, grapeseed, peanut or sunflower oil.
- Place a foil-lined baking tray on a rack in position 2 to catch the oil falling from the food. For highfat foods like chicken wings, add a few sheets of parchment paper to absorb the fat.
- Check food often and shake it or turn it over for crisper results.
- Prepared frozen foods may cook faster with the Air Fry mode than stated on the package. Reduce the cooking time by about 20 percent, check food early, and adjust cooking time as needed.
- Use a food thermometer to make sure food has reached a safe temperature for consumption. Eating undercooked meats can increase your risk of food-borne illness.
- For the crispiest results, dredge fresh chicken wings or tenders in seasoned flour. Use 1/3 cup flour for 2 pounds of chicken.

Recommendations When Air Frying High-Fat Foods

Foods high in fat will smoke when using the Air Fry mode. For best results, follow these recommendations when air frying foods that are high in fat, such as chicken wings, bacon, sausage, hot dogs, turkey legs, lamb chops, ribs, pork loin, duck breasts, or some plant-based proteins.

- Turn on your exhaust hood at a high fan setting before you start Air Fry and leave it on for 15 minutes after you're done.
- Open a window or sliding glass door, if possible, to make sure the kitchen is well-ventilated.
- Clean the grease filters on your exhaust hood regularly.
- Keep the oven free from grease buildup. Wipe down the interior of the oven before and after air frying (once the oven has cooled).
- Run oven cleaning cycles (Easy Clean or SelfClean) regularly, depending on how often and what types of food you Air Fry.
- Avoid opening the oven door more than necessary to help maintain the oven temperature, prevent heat loss, and save energy.
- Air-frying fresh chicken pieces such as wings or drumsticks with the skin left on can produce smoke as the fat renders at high temperatures. If the smoke is excessive, use the Convection Roast mode instead of Air Fry.

Lower Oven

AIR FRY(cont.)

Recommended Air Frying Guide

- Arrange food evenly in a single layer.
- Put a foil-lined baking pan on a rack in position 2 to catch drips. If needed, add parchment paper to absorb oil and reduce smoking.
- Flip food over during cooking to avoid burning it.

Recommended Items	Quantity (oz)	Temp. (°F)	Rack Position	Time (minutes)	Guide
POTATOES-Frozen					
French Fries (Shoestring)	20	425	3	15-25	
French Fries (Crinkle cut, 10x10 mm)	35	400	3	18-28	
Sweet Potato Fries	25	400	3	15-25	
Tater Tots	50	425	3	18-28	
Hash Browns	40	425	3	18-28	
POTATOES-Fresh/Homemade					
French Fries (10x10 mm)	25	425	3	20-30	Cut the potatoes and soak for 30 minutes in hot tap water. Drain and pat dry. Brush or lightly spray with 3 tbsp. of oil. Add salt and pepper to taste.
Potato Wedges	60	425	3	30-40	
CHICKEN-Frozen					
Chicken Nuggets, Crispy	30	400	3	15-25	
Chicken Strips	35	400	3	25-35	
Hot Wings, Bone-in	50	400	3	25-35	
CHICKEN-Fresh, Skin on					
Chicken Wings [†]	40	450	3	25-35	Brush or lightly spray with 1 tbsp. of oil. Add salt and Fresh Chicken pepper to taste.
Drumsticks [†]	70	450	30-40		
Thighs	40	450	3	25-35	
Breasts	40	450	3	25-35	
OTHER					
Frozen Onion Rings, Breaded	20	400	3	15-25	
Frozen Spring Rolls (0.7 oz each)	45	400	3	15-25	
Thin Sausage (2.5 oz each, diameter 0.8")	90	400	3	15-25	
Frozen Coconut Shrimp	25	400	3	15-25	Brush or lightly spray the surface of food with oil.
Fresh Scallops on the half shell (35.3 oz)	35	400	3	15-25	Melt 4 tbsp. of butter and brush on scallops. Mix 1/2 cup bread crumbs, 1 tbsp. minced garlic, 1/4 cup grated Parmesan cheese and season to taste. Sprinkle mixture over scallops.
Fresh Shrimp	50	400	3	15-25	
Mixed Vegetables	35	425	3	13-23	Brush or lightly spray with 4 tbsp. of olive oil. Add salt and pepper to taste.

[†] High-fat items may produce more smoke when cooked using Air Fry. For less smoke, cook using Convection Roast mode.

Lower Oven

PROBE MODE

⚠ WARNING

Consuming undercooked food can result in foodborne illness. Use probe according to the following instructions to ensure all portions of the food reach minimum safe cooking temperatures. Recommendations for minimum safe food temperatures can be found at foodsafety.gov.

⚠ ADVERTENCIA

Consumir comidas sin cocción completa podrá generar enfermedades producidas a través de la comida. Use la sonda de acuerdo con las siguientes instrucciones para asegurar que todas las partes de la comida alcancen las temperaturas mínimas de seguridad en la cocción. Podrá acceder a recomendaciones sobre temperaturas mínimas de seguridad en la cocción en foodsafety.gov.

The probe accurately measures the internal temperature of meat, poultry and casseroles. Always unplug and remove the probe from the oven before removing food. Before using, insert the probe into the center of the thickest part of meat or into the inner thigh or breast of poultry, away from fat or bone. For best performance, the probe should be fully inserted into the food. Place food in the oven and connect the meat probe to the jack. Keep the probe as far away from heat sources as possible.

- The probe cannot be used in the Broil, Sous Vide, Steam Maintenance, Self Clean, Easy Clean, Warm or Proof modes.

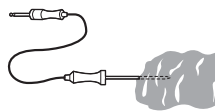

- For thin cuts of meat, insert probe in thickest side of meat.

Using the Meat Probe Feature

1. Insert the probe into the food.
2. Connect the probe to the jack in the oven. **"Probe is connected"** pops up in the display and the probe icon appears at the top of the display.

3. Touch an appropriate cooking mode.
4. Set the oven temperature and the probe temperature. Scroll through the numbers on the display or touch the number pad icon to enter the numbers directly.
 - The default probe temperature is 150°F (65°C), but can be changed to any temperature between 80°F (27°C) and 210°F (100°C).
5. If desired, set the delayed start time using the same method. Touch the **arrow key** on the right side of the display to see the additional settings.
6. Touch **Start**. If a delayed start time has been set, the start time appears in the display.
7. When the set probe temperature is reached, the oven shuts off automatically.

NOTE: Calculating a total cooking time by weight is no longer necessary using this feature. See the Recommended Probe Temperature Chart to set the probe temperature.

Changing the Probe Temperature while Cooking

1. Touch **Edit** in the display to bring up the Cook Settings screen.
2. Adjust the settings as desired.
3. Touch **Start**.

To Stop Cooking

Touch **Stop** in the display, and select **Yes**.

NOTE:

- Touch Stop in the display at any time to cancel a cooking operation.
- To avoid breaking the probe, make sure food is completely defrosted before inserting.
- While the meat probe mode is running,

Lower Oven

RECOMMENDED PROBE GUIDE

Recommended Probe Placement Temperature Chart

Category	Examples of Food	Probe Placement	Desired Doneness
Ground Meat & Meat Mixtures	Meatloaf	Insert in the thickest part	160°F (71°C)
	Meatballs		165°F (74°C)
Fresh Beef, Veal, Lamb	Steaks, Roasts, Chops	Insert in the thickest part, away from bone, fat and gristle	Rare: 120°F (49°C) Medium rare: 125°F (52°C) Medium: 130°F (54°C) Medium well done: 135°F (57°C) Well done: 140°F (60°C)
Poultry	Whole Chicken or Turkey	Insert in the thickest part of thigh, avoiding bone	165°F (74°C)
	Poultry Breasts or Roasts		
	Duck, Goose, Pheasant		
	Stuffing (Alone or in Bird)		
Pork & Ham	Fresh Pork	Insert in the thickest part, away from bone, fat and gristle	Well done: 170°F (77°C)
	Fresh Ham (Raw)		
	Precooked Ham (Reheat & Serve)		Well done: 160°F (71°C)
Leftovers & Casseroles	Leftovers	Insert in the thickest part of the dish	165°F (74°C)
	Casseroles		
Seafood	Whole Fish	Insert in the thickest part of the fish	145°F (63°C)
	Fish Fillet (Side of Fish)		
	Fish Steaks or Portions		

Lower Oven

FAVORITE MODE

For frequently used cooking menus, you can combine up to three different temperatures and cooking modes into one hot key.

Creating a Favorite

- When combining two or more cooking modes, a cooking time or probe temperature must be set before selecting an additional cooking mode.
 - The Probe function cannot be used with the Broil, Sous Vide, Steam Maintenance, Self-clean, Easy Clean, Warm, or Proof modes.
1. Touch **Favorite** in the Cooking Modes screen.
 2. Touch **Create** to make a new hot key.
 3. Select a cook mode listed in the display and set the desired cook temperature.
 4. Touch **Set Cook Time** or **Set Probe**.
 5. If there are no additional cooking stages, touch **Done**. To add another cooking stage, set a cooking time or probe temperature for the previous stage. Then touch **Add Cook Stage**.
 6. Repeat steps 3-5 until all desired cooking stages have been entered. Then touch **Done**.
 7. Enter a name for your recipe using the keyboard and touch **Save**.
 8. The recipe name is added to the Favorite menu.

NOTE:

- If the probe was inserted in the oven jack to add a probe temperature, remember to remove it.
- Proofing doesn't operate when the oven is above 125°F (52°C).
- If using Proof after cooking, wait for the oven to cool first.
- The Proof mode can only be set as a single stage, not as part of multi-stage cooking.

Editing a Favorite

- The Edit function cannot add or remove cooking stages to a recipe. Only the oven temperature, probe temperature and cook time can be changed.
1. Touch **Favorite** in the Cooking Modes screen.
 2. Select the recipe to edit then touch the **pencil icon** at the bottom left of the screen.
 3. Edit the settings for the first cooking stage and touch **Done** to proceed to the next cooking stage, if any.
 4. Edit the next cooking stage, touch **Done**, and proceed through all cooking stages in the same way.
 5. Once the last cooking stage has been edited, enter a new name for the recipe or keep the previous name. Then touch **Save**.

Deleting Favorite

1. Touch **Favorite** in the Cooking Modes screen.
2. Select the recipe and touch the **trash can icon** at the bottom left of the screen.
3. Touch **Yes**.

Lower Oven

PRECISION COOK MODE

The Precision Cook function provides guidance for cooking foods or dishes that may be unfamiliar. It contains preset programs for cooking many popular food items, with information on recommended preheating, accessories, and rack position for optimal results.

NOTE: This function provides pre-programmed timing and power levels for Probe recipes only. For nonprobe recipes, oven must be turned off manually when finished cooking.

Setting Precision Cook Mode

1. Touch **Precision Cook** in the Cooking Modes screen.
2. Touch a category to filter the options.
3. Scroll through or tap the letters to find and select an item.
4. Follow the recommendations in the display regarding accessories and rack position.
5. Touch **Start**.

PRECISION COOK GUIDE

If using probe, insert after preheating.

NOTE: When cooking thin cuts of meat, insert the probe into the thickest part of the meat. If the probe is inserted incorrectly, the oven could turn off too soon. See the Probe section for instructions.

Menu		Accessories/Cookware	Shelf Position	Cooking time in min. (side 1 + side 2)
Beef	Beef Tenderloin	Grid on broiler pan	Rare	2 30-60
			Medium rare	2 35-65
			Medium	2 40-70
			Medium well done	2 45-75
			Well done	2 50-80
	Pot Roast	Ovenproof pot with cover	2	50-80
	Roast Beef		Rare	2 40-70
			Medium rare	2 45-75
			Medium	2 50-80
			Medium well done	2 55-85
			Well done	2 60-90
	London Broil	Grid on broiler pan	Rare	5 3-10 + 3-10
			Medium rare	5 5-15 + 3-10
			Medium	5 5-15 + 5-10
			Medium well done	5 ~15 + 5-10
			Well done	5 10-15 + 8-15
	Steak		Rare	5 3-10 + 3-10
			Medium rare	5 5-15 + 3-10
			Medium	5 5-15 + 5-10
			Medium	5 8-15 + 5-10
Well done			5 10-15 + 8-15	
Beef	Beef Marinade	Grid on broiler pan	3	20-50
	Meat Loaf	Loaf pan	2	40-60
Pork	Pork Butt	Casserole dish	2	60-90
	Pork Chops	Grid on broiler pan	4	30-50
	Pork Loin		2	50-80
	Pork Tenderloin		2	20-40
Veal	Veal Top Sirloin	Grid on broiler pan	2	80-100
	Veal Chops		5	4-15 + 3-10
	Veal Rolled Roast		2	50-70
	Veal Rib Roast		2	50-80
	Veal Tenderloin		2	50-80

Lower Oven

PRECISION COOK GUIDE (Cont.)

Menu		Accessories/Cookware	Shelf Position	Cooking time in min. (side 1 + side 2)	
Fish	Fish Fillet	Baking dish	4	10~15	
	Whole		4	15~30	
	Shrimp	Grid on broiler pan	5	5~15	
	Lobster Tails		4	20~30	
	Salmon Steak	Rare	Baking dish	4	5~20
		Medium rare		4	20~25
Well done		4		15~30	
Poultry	Chicken	Legs & Thighs	4	20~40	
		Wings (Fresh)	Grid on broiler pan	5	8~20
		Wings (Frozen)		4	20~40
		Breasts	Baking dish	4D	20~40
	Cutlet	Casserole dish	4	20~30	
	Whole	Grid on broiler pan	2	60~80	
	Whole Turkey		2	150~240	
Casserole	Lasagna (Fresh)	Baking dish	3	50~70	
Pizza	Frozen Thin Crust	Directly on rack	3	10~20	
		On pizza pan	3	10~20	
		On pizza stone	3	10~20	
	Frozen Rising Crust	Directly on rack	3	10~20	
		On pizza pan	3	10~20	
		On pizza stone	3	10~20	
	From Scratch/Homemade	Directly on rack	3	10~20	
On pizza pan		3	10~20		
On pizza stone		3	10~20		
Desserts	Brownies	Baking dist	3	30~40	
	Cheesecake	Cake pan	3	60~70	
	Fruit Pie	Whole Pie	Pie pan	3	25~45
		Par Bake Bottom Crust Only		3	20~40
	Fruit Tart	Tart pan	3	20~40	
	Cakes	Layer Cake	Cake pan	3	25~45
		Angel Food Cake		3	30~40
	Muffins/Cupcakes	Muffin pan	3	20~30	
	Puff Pastry	Baking Sheet	3	20~40	
	Cookies		Single Tray	3	15~20
			Multiple Trays	2 + 4	20~28
Biscuits/Scones	3		10~20		
Soufflé	Soufflé dish	2	60~80		
Misc.	Proof	Oven bowl with cover	3	30~40	
	Drying/Dehydrating	Baking sheet	3	120~480	
	Slow Roasting	Grid on broiler pan	2	120~240	
Bread (Steam)	White Bread	Homemade	Loaf pan	3	20~50
		Frozen		3	20~50
		Par Baked		3	20~50
	Baguette	Homemade	Perforated baguette pan	3	15~35
		Frozen		3	15~35
		Par Baked		3	15~35
	Cinnamon Raisin Bread	Loaf pan	3	20~40	
	Walnut Bread	Loaf pan or perforated tray	3	40~50	
	Whole Grain Bread	Homemade	Loaf pan	3	25~45
				Frozen	3
Par Baked		3		25~45	
		Homemade		3	25~50
Banana Bread	Homemade	3	25~50		

Lower Oven

STEAM FUNCTION

Steam cooking uses the moist heat of steam to cook food. This is an ideal cooking method for delicate food items such as seafood, which can lose nutrients when boiled.

The oven provides 2 methods of steam cooking: **Steam Bake** and **Sous Vide**.

Using the Steam Feeder Tank

The steam feeder tank is located over the oven cavity.

1. Gently push the front of the steam feeder tank to slide it out.

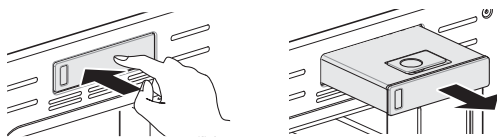

2. Remove the tank and place it on a flat surface.
3. Remove the tank cover or flip open the fill lid at the front of the tank cover.

4. Fill the tank to the max line located at the front of the tank. Use softened, filtered water, if possible. Hard water may clog the steam generator more quickly with scale buildup.

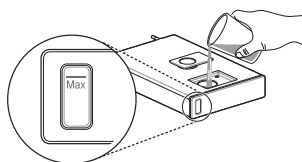

5. Assemble the cover or snap closed the fill lid.

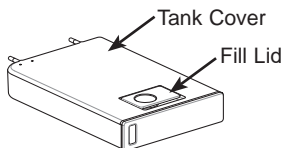

6. Carefully insert the tank into the steam feeder slot, making sure to keep the tank level while carrying it. If the tank is not kept level, water will drain out of the tubes in the back.

7. Slide the tank into the slot until it clicks into place.

STEAM BAKE MODE

The Steam Bake mode heats food gradually, using both the oven heating elements and moist steam heat. The oven can be programmed to cook at any temperature from 210°F (100°C) to 550°F (285°C).

Preset temperature options start at 350°F (175°C).

Setting Steam Bake Mode

1. Touch **Steam Cook** in the Cooking Modes screen.
2. Touch **Steam Bake** in the display.
3. Select the desired temperature and steam level: **Low**, **Medium**, or **High**.
4. If desired, scroll to set the cook time and delayed start time. Touch the **arrow key** on the right side of the display to see the delayed start time settings.
5. Touch **Start**.
6. Once cooking is finished, allow the oven to cool completely. Then wipe up any water left on the oven interior.

NOTE:

- Once Steam Bake cooking is started, an indicator on the display shows the status of the steam function.
- Make sure the steam feeder tank is filled with water before starting the Steam Bake mode. If the water in the tank runs out during cooking, a chime sounds and a popup appears in the display. The oven continues to cook without steam.
- Remember to drain the steam feeder tank after use.
- When the temperature rises in the oven, steam may not be visible.
- It is normal to hear the sound of boiling water from the steam generator while running the steam functions.

Changing the Steam Cook Settings

1. Touch **Edit** in the display to bring up the Cook Settings screen.
2. Adjust the settings as desired.
3. Touch **Start**.

To Stop Steam Cooking

Touch **Stop** in the display, and select **Yes**.

Lower Oven

SOUS VIDE

Sous vide cooking uses steam to cook foods “low and slow.” Use it to cook meat, fish, seafood, poultry or vegetables. Food must be vacuum packed in pouches.

It is not necessary to preheat the oven when using sous vide.

Refer to the cooking guide for recommended sous vide settings.

Benefits of Sous Vide

The lower temperatures and long cooking times used in sous vide cooking provide many benefits.

■ Healthier

Compared to other cooking methods, sous vide retains most of the original nutrients in food.

■ Safe and Convenient

The long cooking times used in sous vide cooking allow food to be pasteurized. Because food is vacuum packed before cooking, the unopened pouches can be quickly chilled then easily stored after cooking.

■ Crisp and Moist Results

The fine temperature control of sous vide cooking is an excellent way to achieve the perfect texture when cooking meat and poultry. The low temperatures used retain more of the moisture in food than conventional cooking methods. After cooking, a final sear in a frying pan adds the perfect crisp finish.

Setting Sous Vide Mode

1. Fill the tank with water up to the max line located at the front of the tank.
2. Place the standard rack in position 3 and place the sealed food bag on it.
3. Touch **Steam Cook** in the Cooking Modes screen.
4. Touch **Sous Vide** in the display.
5. Select the desired temperature.
6. If desired, scroll to set the cook time and delayed start time. Touch the **arrow key** on the right side of the display to see the delayed start time settings.
7. Touch **Start**.

8. Once cooking is finished, allow the oven to cool completely. Then wipe up any water left on the oven interior.

Changing the Sous Vide Settings

1. Touch **Edit** in the display to bring up the cook settings screen.
2. Adjust the settings as desired.
3. Touch **Start**.

To Stop Cooking

Touch **Stop** in the display, and select **Yes**.

NOTE: As the temperature in the oven rises, steam may not be visible.

SOUS VIDE COOKING GUIDE

The size, weight, thickness, set temperature, and your personal preferences will affect operating times. This guide is only for reference. Adjust cook time according to your preference.

Food	Quantity (oz)	Temp. (°F)	Time		
			Min	Target	Max
Beef Steak (Medium rare)	1" thick 14.1-17.6 oz	135	-	2.5 hr.	3 hr.
Chicken breast	4.2-5.3 oz	149	-	2.5 hr.	3 hr.
Salmon	1" thick 7 oz	140	-	2 hr.	2.5 hr.
Asparagus	2.8 oz / 6 ea 5.6 oz / 12 ea	185	20 min.	30 min.	45 min.

- Cook 30 mins. or 1 hour more if you use meats thicker than 1”.
- If you use larger cuts of meat, cut to match the recommended weight. For multiple pieces of meat sealed in separate bags, be careful not to put pieces of meat too close together.

Cleaning the Oven

Be sure all controls are off and all surfaces are cool before cleaning any part of the range.



⚠ WARNING

If your range is removed for cleaning, servicing or any reason, be sure the anti-tip device is reengaged properly when the range is replaced. Failure to take this precaution could result in tipping of the range and can result in death or serious burns to children or adults.

NOTE: DO NOT allow stainless steel cleaner to come in contact with any plastic parts such as the control knobs or control panel. If unintentional contact of cleaners with plastic parts does occur, clean plastic part with a sponge and mild detergent mixed with warm water.

NOTE: The ceramic cooktop cleaner is NOT recommended for use on external painted surfaces.

Asegúrese de que todos los controles estén apagados y que las superficies estén frías antes de limpiar cualquier parte de la cocina.



⚠ ADVERTENCIA

Si se quita la cocina para efectuar una limpieza, reparaciones o cualquier otra razón, verifique que el dispositivo anti-volcaduras se coloque de manera adecuada cuando vuelva a instalarse la cocina. Si no toma esta precaución, la cocina puede volcarse y provocar lesiones.

NOTA: NO permita que el limpiador de acero inoxidable entre en contacto con cualquier parte plástica tal como las perillas de control o el panel de control.

Si se produce un contacto no intencional de los limpiadores con las partes plásticas, limpie la parte plástica con una esponja y un detergente suave mezclado con agua caliente.

NOTA: NO se recomienda el uso del limpiador de la superficie de cocción de cerámica sobre las superficies exteriores pintadas.

CLEANING

General Cleaning Tips

- A plastic spatula can be used as a scraper to scrape off any chunks or debris before and during oven cleaning.
- Using the rough side of a non-scratch scouring pad may help to take off burnt-on stains better than a soft sponge or towel.
- Certain non-scratch scrubbing sponges, such as those made of melamine foam, available at your local stores, can also help improve cleaning.

Wipe well with a clean cloth. Over time, stains can occur on the surfaces as the result of food particles spattering during cooking. This is normal.

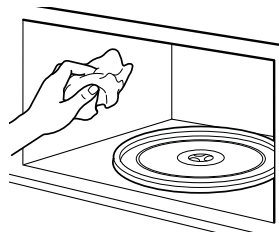

CLEANING THE INTERIOR - UPPER OVEN

Wash often with warm, sudsy water and a sponge or soft cloth. Use only mild, non-abrasive soaps or a mild detergent. Keep the areas clean where the door and oven frame touch when closed.

For stubborn soil, boil a cup of water in the oven for 2 to 3 minutes. Steam will soften the soil. To get rid of odors inside the oven, boil a cup of water with some lemon juice or vinegar in it.

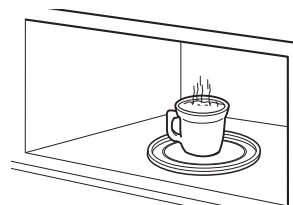

Cleaning the Oven

CLEANING THE INTERIOR - UPPER OVEN (Cont.)

Glass Tray and Rotating Ring

To clean the glass tray and rotating ring, wash in mild, sudsy water.

For heavily soiled areas use a mild cleanser and scouring sponge.

NOTE: The glass tray and rotating ring are dishwasher safe.

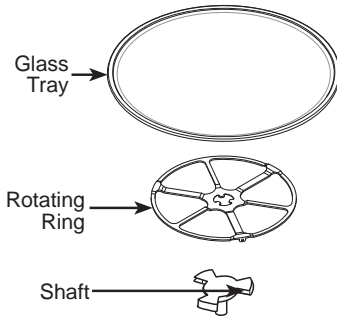

CLEANING THE EXTERIOR

Control Panel

To prevent activating the control panel during cleaning, disconnect power to the appliance. Clean up splatters with a damp cloth using a glass cleaner. Remove heavier soil with warm, soapy water. Do not use abrasives of any kind.

Painted and Decorative Trim

For general cleaning, use a cloth with hot soapy water. For more difficult soils and built-up grease, apply a liquid detergent directly onto the soil.

Leave it on for 30 to 60 minutes. Rinse with a damp cloth and dry. Do not use abrasive cleaners.

Stainless Steel Surfaces

To avoid scratches, do not use steel wool pads.

1. Place a small amount of stainless steel appliance cleaner or polish on a damp cloth or paper towel.
2. Clean a small area, rubbing with the grain of the stainless steel if applicable.
3. Dry and buff with a clean, dry paper towel or soft cloth.
4. Repeat as necessary.

NOTE

- To clean the stainless steel surface, use warm sudsy water or a stainless steel cleaner or polish.
- Always wipe in the direction of the metal surface finish.
- Stainless steel appliance cleaner or polish can be purchased online or from most retailers of appliances or home goods.

Oven Doors

- Use soapy water to thoroughly clean the oven door. Rinse well. Do not immerse the door in water.
- You may use a glass cleaner on the outside glass of the oven door. Do not spray water or glass cleaner on the door vents.
- Do not use oven cleaners, cleaning powders, or harsh abrasive cleaning materials on the outside of the oven door.
- Do not clean the oven door gasket. The oven door gasket is made of a woven material that is essential for a good seal. Care should be taken not to rub, damage, or remove this gasket.

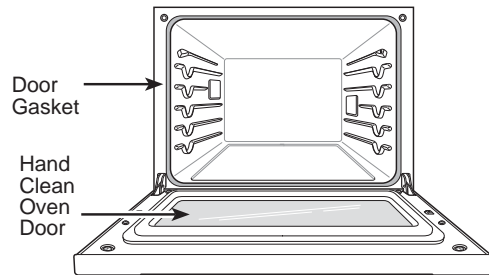

Cleaning the Oven

CLEANING INTERIOR - LOWER OVEN

Broiler Pan and Grid

- Do not store a soiled broiler pan or grid anywhere in the appliance.
- Do not clean the broiler pan or grid in a self cleaning mode.
- Remove the grid from the pan. Carefully pour out the grease from the pan into a proper container.
- Wash and rinse the broiler pan and grid in hot water with a soap-filled or plastic scouring pad.
- If food has burned on, sprinkle the grid with cleaner while hot and cover with wet paper towels or a dishcloth. Soaking the pan will remove burned-on foods.
- Both the broiler pan and grid may be cleaned with a commercial oven cleaner or in the dishwasher.

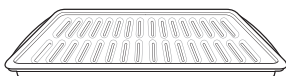

Oven Racks

Remove the oven racks before operating the Self Clean cycle and EasyClean.

1. Clean with a mild, abrasive cleaner.
Food spilled into the tracks could cause the racks to become stuck.
2. Rinse with clean water and dry.

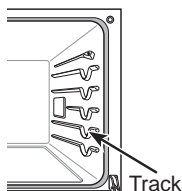

NOTE: If the racks are cleaned using the Self Clean cycle (not recommended), the color will turn slightly blue and the finish will become dull. After the Self Clean cycle is complete, and the oven has cooled, rub the sides of the racks with wax paper or a cloth containing a small amount of vegetable oil. This will make the racks glide more easily into the rack tracks.

Oven Cavity

DO NOT use oven cleaners.

NEVER wipe a warm or hot porcelain surface with a damp sponge; it may cause chipping or crazing (tiny hairlike cracks). Food spills should be cleaned when the oven cools. At high temperature, foods react with porcelain and a permanent dull spot can result. When cleaning a spot, use only nonabrasive cleaners or scrubbers.

EASYCLEAN

EasyClean enamel technology provides two cleaning options for the inside of the oven. The EasyClean feature lift soils without harsh chemicals, and it runs using **ONLY WATER** for just 10 minutes in low temperatures to help loosen **LIGHT** soils before hand cleaning.

While EasyClean is quick and effective for small and **LIGHT** soils, the Self Clean feature can be used to remove **HEAVY**, built up soils. The intensity and high heat of the Self Clean cycle may result in smoke which will require the opening up of windows to provide ventilation. Compared to the more intense Self Clean process, this gives you the option of cleaning with **LESS HEAT, LESS TIME, and virtually NO SMOKE OR FUMES**. You can reduce energy use by cleaning light oven soils with the EasyClean feature instead of Self Clean.

When needed, the oven still provides the Self Clean option for longer, more thorough oven cleaning for heavier, built up soils.

- For hard to reach areas such as the back surface of the oven, it is better to use the Self Clean cycle.

Cleaning the Oven

EASYSOIL (Cont.)

Benefits of EasyClean

- Helps loosen light soils before hand-cleaning
- EasyClean only uses water; no chemical cleaners
- Makes for a better Self Clean experience.
 - Delays the need for a Self Clean cycle
 - Minimizes smoke and odors
 - Can allow shorter Self Clean time

When to Use EasyClean

Example of oven soiling

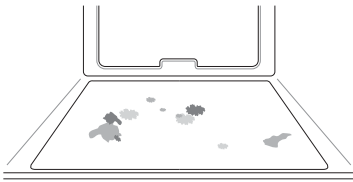

■ Case 1

- Soil pattern: Small drops or spots
- Types of soils: Cheese or other ingredients
- Common food items that can soil your oven: Pizza

■ Case 2

- Soil pattern: Light splatter
- Types of soils: Fat/grease
- Common food items that can soil your oven: Steaks, broiled / Fish, broiled / Meat roasted at low temperatures.

EasyClean Instruction Guide

- Allow the oven to cool to room temperature before using the EasyClean cycle. If your oven cavity is above 150°F (65°C), the EasyClean cycle will not be activated until the oven cavity cools down.
- The oven should be level to ensure that the bottom surface of the oven cavity is entirely covered by water at the beginning of the EasyClean cycle.
- For best results, use distilled or filtered water. Tap water may leave mineral

deposits on the oven bottom.

- Soil baked on through several cooking cycles will be more difficult to remove with the EasyClean cycle.

- Do not open the oven door during the EasyClean cycle. Water will not get hot enough if the door is opened during the cycle.

1. Remove oven racks and accessories from the oven.

2. Scrape off and remove any burnt-on debris with a plastic scraper.

- Suggested plastic scrapers:

- Hard plastic spatula
- Plastic pan scraper
- Plastic paint scraper

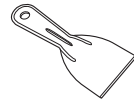

3. Fill a spray bottle (10 oz or 300 ml) with water and use the spray bottle to thoroughly spray the inside surfaces of the oven.

4. Use at least 1/5 (2 oz or 60 ml) of the water in the bottle to completely saturate the soil on both the walls and in the corners of the oven.

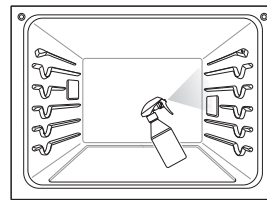

5. Spray or pour the remaining water (8 oz or 240 ml) onto the bottom center of the oven cavity. The indentation on the oven bottom should be fully covered to submerge all soils. Add water if necessary.

NOTE: Use an entire bottle of water to clean each oven. Do not spray water directly on the door. Doing so will result in water dripping to the floor.

6. Touch **Clean** in the Cooking Modes screen. Touch **EasyClean** in the display.

7. Touch **Start**. The remaining time appears in the display.

Cleaning the Oven

EASYSOAK (Cont.)

EasyClean Instruction Guide (Cont.)

8. A tone will sound at the end of the 10 minute cycle. Touch End of the Cleaning in the display to end the EasyClean mode and the tone.
9. After the cleaning cycle and during handcleaning, enough water should remain on the oven bottom to completely submerge all soils. Add water if necessary. Place a towel on the floor in front of the oven to capture any water that may spill out during hand-cleaning.
10. Clean the oven cavity immediately after the EasyClean cycle by scrubbing with a wet, nonscratch scouring sponge or pad. (The scouring side will not scratch the finish.) Some water may spill into the bottom vents while cleaning, but it will be captured in a pan under the oven cavity and will not hurt the burner.

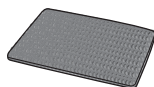

NOTE: Do not use any steel scouring pads, abrasive pads or cleaners as these materials can permanently damage the oven surface.

11. Once the oven cavity is cleaned, wipe any excess water with a clean dry towel. Replace racks and any other accessories.

12. If some light soils remain, repeat the above steps, making sure to thoroughly soak the soiled areas.

- If stubborn soils remain after multiple EasyClean cycles, run the Self Clean cycle. Be sure that the oven cavity is empty of oven racks and other accessories, and that the oven cavity surface is dry before running the Self Clean cycle. Consult the Self Clean section of your owner's manual for further details.

NOTE:

- The cavity gasket may be wet when the EasyClean cycle finishes. This is normal. Do not clean the gasket.
- If mineral deposits remain on the oven bottom after cleaning, use a cloth or sponge soaked in vinegar to remove them.
- It is normal for the fan to operate during the EasyClean cycle.
- Using commercial oven cleaners or bleach to clean the oven is not recommended. Instead, use a mild liquid cleanser with a pH value below 12.7 to avoid discoloring the enamel.

Cleaning the Oven

SELF CLEAN (LOWER OVEN)

The Self Clean cycle uses extremely hot temperatures to clean the oven cavity. While running the Self Clean cycle, you may notice smoking or an odor. This is normal, especially if the oven is heavily soiled. During Self Clean, the kitchen should be well ventilated to minimize the odors from cleaning.

Before Starting Self Clean

- Clean only parts listed in manual. Remove the water tank, oven racks, broiler pan, broiler grid, all cookware, aluminum foil or any other material from the oven.
 - If oven racks are left in the oven cavity during the Self Clean cycle, they will discolor and become difficult to slide in and out.
 - If you don't remove the water tank from the oven, a beep sounds and the Self Clean cycle does not start.
- The kitchen should be well ventilated to minimize the odors from cleaning. Open a window or turn on a ventilation fan or hood before self-cleaning.
- Wipe any heavy spillovers on the bottom of the oven.
- Make sure that the oven light cover is in place and the oven light is off.
- Clean the frame of the oven and door with hot soapy water. Rinse well.
- **NOTE:** The oven light cannot be turned on during a Self Clean cycle. The oven light cannot be turned on until the oven temperature has cooled below 500°F (260°C) after a Self Clean cycle is complete.
- Clean the frame of the oven and door with hot soapy water. Rinse well.

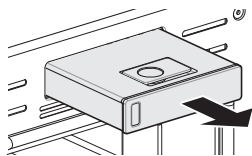

- Do not clean the gasket. The fiberglass material of the oven door gasket cannot withstand abrasion. It is essential for the gasket to remain intact. If you notice it becoming worn or frayed, replace it.
- It is normal for the fan to operate during the Self Clean cycle.
- As the oven heats, you may hear sounds of metal parts expanding and contracting. This is normal and will not damage the oven.
- You may notice some white ash in the oven. Wipe it off with a damp cloth or a soap-filled steel wool pad after the oven cools. If the oven is not clean after one Self Clean cycle, repeat the cycle.
- If oven racks were left in the oven and do not slide smoothly after a Self Clean cycle, wipe racks and rack tracks with a small amount of vegetable oil to make them glide more easily.
- After a Self Clean cycle, fine lines may appear in the porcelain because it went through heating and cooling. This is normal and will not affect performance.
- The Self Clean cycle cannot be started if the Lock Out feature is active.
- Once the Self Clean cycle is set, the oven door locks automatically. You will not be able to open the oven door until the oven is cooled. The lock releases automatically.
- Allow about 15 seconds for the oven door lock to activate.
- If the clock is set for a 12-hour display (default) the Delayed Self Clean can never be set to start more than 12 hours in advance.
- After the oven is turned off, the cooling fan keeps operating until the oven has cooled down.

Cleaning the Oven

SELF CLEAN (LOWER OVEN) (Cont.)

When to Use Self Clean

- Example of oven soiling

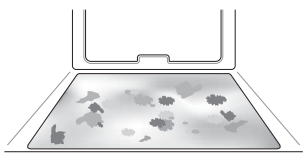

■ Case 1

- Soil pattern: Medium to heavy splatter
- Types of soils: Fat/grease
- Common food items that can soil your oven:
Meat roasted at high temperatures

■ Case 2

- Soil pattern: Drops or spots
- Types of soils: Filling or sugar based soils
- Common food items that can soil your oven: Pies

■ Case 3

- Soil pattern: Drops or spots
- Types of soils: Cream or tomato sauce
- Common food items that can soil your oven:
Casseroles

NOTE: The Self Clean cycle can be used for soil that has been built up over time.

Setting Self Clean

The Self Clean function has cycle times of 3, 4, or 5 hours.

Self Clean Soil Guide

Soil Level	Cycle Setting
Lightly Soiled Oven Cavity	3-Hour
Moderately Soiled Oven Cavity	4-Hour
Heavily Soiled Oven Cavity	5-Hour

1. Remove all racks and accessories from the oven.
2. Touch **Clean, Self Clean** in that order. The oven defaults to the recommended four hour self clean for a moderately soiled oven.
3. Select the desired cycle time.

4. If desired, scroll to set a delayed start time or touch the number pad icon to enter the start time directly.
5. **Touch Start. The remaining time or the delayed start time appears in the display.**
6. Once the self-clean cycle is set, the oven door locks automatically and the lock icon displays.
 - You will not be able to open the oven door until the oven has cooled. The lock releases automatically when the oven has cooled. Forcing the door open will damage the door.
 - It may become necessary to cancel or interrupt a Self Clean cycle due to excessive smoke or fire in the oven. To cancel the Self Clean function, touch **Stop** in the display.

During Self Clean

- The Self Clean cycle uses extremely hot temperatures to clean the oven cavity. While running the Self Clean cycle, you may notice smoking or an odor. This is normal, especially if the oven is heavily soiled.
- As the oven heats, you may hear sounds of metal parts expanding and contracting. This is normal and will not damage the oven.

After the Self Clean Cycle

- The oven door remains locked until the oven temperature has cooled. Forcing the door open will damage the door.
- You may notice some white ash in the oven. Wipe it off with a damp cloth or a soap-filled pad after the oven cools. If the oven is not clean after one self-clean cycle, repeat the cycle.
- If oven racks were left in the oven and do not slide smoothly after a self-clean cycle, wipe racks and rack supports with a small amount of vegetable oil to make them glide more easily.
- Fine lines may appear in the porcelain because it went through heating and cooling. This is normal and will not affect performance.

Cleaning the Oven

CLEANING THE STEAM FEEDER TANK

The steam feeder tank is used during the steam cooking functions. Use filtered, softened water if possible.

NOTE:

- After using the steam function, the steam feeder tank should be drained. To avoid bacteria or odors, clean and dry the steam feeder tank after every use.
- Do not clean in a dishwasher.
- If the steam feeder tank does not slide in as smoothly as it should, clean the bottom of the tank.
- After the steam mode is used for 8 hours, a reminder to descale the product appears in the display the next time the steam mode is selected. You will not be able to use the steam mode until the Descaling function is run. To avoid this delay, run the Descaling function after every 2-3 uses of the steam mode.
- If the descaling reminder appears, press OK to run the Descaling function.

Hard Water Scale

If hard water is used in the steam feeder tank, the steam generator may become clogged with hard water scale. In areas with hard water, run the Descaling function frequently or use softened water.

CLEANING SCALE ON LOWER OVEN BOTTOM

To remove mineral deposits that remain on the oven bottom after using the steam mode, use a cloth or sponge soaked in vinegar or a weak citric acid solution. For more stubborn or extensive scaling, use the Descaling function.

Descaling

Use this function to remove the white deposits that form after the steam generator is used for a long period.

The Descaling function runs for 1 hour 43 minutes. Water will come out of the steam generator while it is being cleaned.

For instructions on removing and filling the steam feeder tank, see “Using the Steam Feeder Tank.”

Setting Descaling

1. Fill the steam feeder tank with a 20:1 mixture of water and citric acid. For example, use 4 tsp of citric acid in 4 1/4 cups water (20 g citric acid in 1000 ml water).

Setting Descaling (Cont.)

2. Insert the steam feeder tank into the slot over the oven cavity and push it in until it clicks into place.
3. Touch **Clean** in the Cooking Modes screen. Touch **Steam Maintenance** and **Descaling** in that order.
4. After 1 hour 43 minutes of descaling, a popup will appear in the display. Following the instructions, drain the tank and fill it with clean water.
5. Insert the tank and start the Rinsing function.
6. Once the Rinsing function is complete, dry the inside of the oven with a soft cloth. Leave the oven door open and allow the oven to dry completely.

NOTE:

- The Rinsing function must be completed even if the Descaling function is cancelled.
- If water remains on the oven bottom after descaling, it can leave a residue after the oven is used. To remove the residue, see the instructions under “Cleaning Scale on Oven Bottom.”
- After running the Descaling function, clean the steam feeder tank.

DRYING THE LOWER OVEN CAVITY AND STEAM GENERATOR

The Drying function removes residual water inside the steam generator. The function takes a little over 1 minute and runs automatically after any steam cooking cycle. The Drying function can also be started manually, if needed.

Cleaning the Oven

DRYING THE LOWER OVEN CAVITY AND STEAM GENERATOR (Cont.)

Setting Drying

1. Make sure that the steam feeder tank is empty.
2. Touch **Clean** in the Cooking Modes screen. Touch **Steam Maintenance** and **Drying** in that order.
3. Touch **Start** to begin Drying. The remaining time appears in the display.

Using Evaporation Function

Use the Evaporation function to dry the oven cavity after a steam cooking cycle. Evaporation runs for 12 minutes.

Setting Evaporation

1. Touch **Clean** in the Cooking Modes screen. Touch **Steam Maintenance** and **Evaporation** in that order.
2. Touch **Start** to begin Evaporation. The remaining time appears in the display.

CHANGING THE OVEN LIGHT

⚠ WARNING SHOCK OR BURN HAZARD: Before replacing oven light bulb, disconnect the electrical power to the oven at the main fuse or circuit breaker panel. Failure to do so may result in electric shock or burn.

⚠ CAUTION BURN HAZARD: The glass cover and bulb should be removed when cool. Touching hot glass with bare hands or a damp cloth can cause burns.

⚠ ADVERTENCIA PELIGRO DE DESCARGA ELÉCTRICA O QUEMADURAS: Antes de reemplazar la bombilla del horno, desconecte la alimentación de energía al horno desde el panel principal de fusibles o del interruptor de circuitos. No hacerlo puede provocar una descarga eléctrica o una quemadura.

⚠ PRECAUCIÓN RIESGO DE INCENDIO: La tapa de vidrio y la lámpara de luz se deberán retirar cuando estén frías. Tocar el vidrio caliente sin protección en las manos o con un trapo húmedo puede ocasionar quemaduras.

The oven light is a standard 25-watt halogen bulb for ovens.

1. Unplug the oven or disconnect power.
2. Remove the oven racks.
3. Slide a flat blade screwdriver a between the housing and the glass light cover.

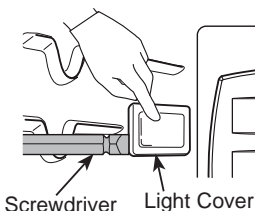

4. Support the glass light cover with two fingers to prevent the cover from falling to the bottom of the oven.

5. Gently twist the screwdriver blade to loosen the glass light cover.

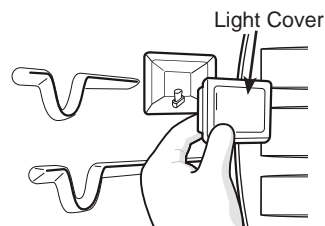

6. Remove the bulb from the socket.
7. Replace the bulb, and reassemble the light cover by snapping it back into place.
8. Plug in the oven or reconnect power.

Troubleshooting FAQs

TROUBLESHOOTING FAQs

Frequently Asked Questions

About the Upper Oven

Q: Can I use a rack in my upper oven to reheat or cook on two levels at once?

A: Only use the rack that is supplied with your upper oven. Use of any other rack can result in poor cooking performance and/or arcing and may damage your oven.

Q: Will the upper oven be damaged if it operates while empty?

A: Yes. Never operate the oven while it is empty or without the glass tray.

Q: Does microwave energy pass through the viewing screen in the door?

A: No. The metal screen bounces the energy back to the oven cavity. The holes (or ports) allow only light to pass through. They do not let microwave energy pass through.

Q: Why do I see a light reflection around the outer case?

A: This light is from the upper oven light which is located between the oven cavity and the outer wall of the oven.

Q: What are the various sounds I hear when the upper oven is operating?

A: The clicking sound is caused by a mechanical switch turning the microwave oven's magnetron ON and OFF.

The heavy hum and clunk is from the change in power the magnetron draws as it is turned ON and OFF by a mechanical switch. The change in blower speed is from the change in line voltage caused by the magnetron being turned ON and OFF.

Q: Can my upper oven be damaged if food is cooked for too long?

A: Like any other cooking appliance, it is possible to overcook food to the point that the food creates smoke and even possibly fire, and damages the inside of the oven. It is always best to be near the oven while you are cooking.

Q: Why is a standing time recommended after microwave cooking time is over?

A: Standing time allows foods to continue cooking evenly for a few minutes after the actual microwave oven cooking cycle. The amount of standing time depends upon the density of the foods.

Q: Why is additional time required for cooking food stored in the refrigerator?

A: As in conventional cooking, the initial temperature of food affects total cooking time. You need more time to cook food taken out of a refrigerator than for food at room temperature.

Q: Can I use either metal or aluminum pans in my upper oven?

A: Usable metal includes aluminum foil for shielding (use small, flat pieces), and shallow foil trays (if tray is $\frac{3}{4}$ inch deep and filled with food to absorb microwave energy). Never allow metal to touch walls or door.

Troubleshooting FAQs

TROUBLESHOOTING FAQs (Cont.)

Q: Sometimes the door of my upper oven appears wavy. Is this normal?

A: This appearance is normal and does not affect the operation of your oven.

Q: Why does the glass tray not move?

A: The correct side of the tray should be facing up and the tray should sit firmly on the center hub. The support is not operating correctly. Reinstall the glass tray and restart the oven. Cooking without the glass tray can give you poor results.

Q: Why does the dish become hot when I microwave food in it? I thought that this should not happen.

A: As the food becomes hot it will conduct the heat to the dish. Use hot pads to remove food after cooking.

Q: What does standing time mean?

A: Standing time means that food should be taken out of the oven and covered for additional time after cooking. This process allows the cooking to finish, saves energy, and frees the oven for other purposes.

Q: Can I pop popcorn in my upper oven? How do I get the best results?

A: Yes. Pop packaged microwave popcorn following manufacturer's guidelines or use the pre-programmed Popcorn button.

Do not use regular paper bags. Use the listening test by stopping the oven as soon as the popping slows to a pop every one or two seconds. Do not try to repop unpopped kernels. You can also use special microwave poppers. When using a popper, be sure to follow manufacturer's directions. Do not pop popcorn in glass utensils.

Q: Why does steam come out of the air exhaust vent?

A: Steam is normally produced during cooking. The upper oven has been designed to vent steam out of the top vent.

About the Lower Oven

Q: My new oven doesn't cook like my old one. Is there something wrong with the temperature settings?

A: No. Your oven has been factory tested and calibrated. For the first few uses, follow your recipe times and temperatures carefully. If you still think your new oven is too hot or too cold, you can adjust the oven temperature yourself to meet your specific cooking needs. Refer to the Changing Settings section in this manual for easy instructions on how to adjust your thermostat.

Q: Is it normal to hear a clicking noise coming from the back of my oven when I am using it?

A: Your new appliance is designed to maintain a tighter control over your oven's temperature. You may hear your oven's heating elements click on and off more frequently on your new oven. This is NORMAL.

Q: Why is the time flashing?

A: This means that the product has just been plugged in, or that it has experienced a power interruption. To clear the flashing time, touch any button and reset the clock if needed.

Q: During convection cooking the fan stops when I open the door. Is that normal?

A: Yes, this is normal. When the door is opened, the convection fan will stop until the door is closed.

Troubleshooting FAQs

TROUBLESHOOTING FAQs (Cont.)

Q: Can I use aluminum foil to catch drippings in my oven cavity?

A: Never use aluminum foil to line the bottom or sides of the oven. The foil will melt and stick to the bottom surface of the oven and will not be removable. Use a foil-lined sheet pan placed on a lower oven rack to catch drippings instead. (If foil has already melted onto the bottom of the oven, it will not interfere with the oven's performance.)

Q: Can I use aluminum foil on the racks?

A: Do not cover racks with aluminum foil. Covering entire racks with foil restricts air flow, leading to poor cooking results. Use a sheet pan lined with foil under fruit pies or other acidic or sugary foods to prevent spillovers from damaging the oven finish.

Q: Can I leave my racks in the oven when running a Self Clean cycle? (On some models)

A: No. Although it will not damage the racks, it will discolor them and may make them hard to slide in and out during use. Remove all items from the oven before starting a Self Clean cycle.

Q: What should I do if my racks are sticky and have become hard to slide in and out?

A: Over time, the racks may become hard to slide in and out. Apply a small amount of olive oil to the sides of the racks. This will work as a lubricant for easier gliding.

Q: Why aren't the function buttons working?

A: Make sure that the appliance is not in Lock Out mode. The lock will show in the display if Lock Out is activated. To deactivate Lock Out, refer to the Lockout Feature section. The unlock melody sounds and Loc appears in the display until the controls are unlocked.

Q: My appliance is still dirty after running the EasyClean cycle. What else should I do?

A: The EasyClean cycle only helps to loosen light soils in your appliance to assist in hand-cleaning of your oven. It does not automatically remove all soils after the cycle. Some scrubbing of your appliance is required after running the EasyClean cycle.

Q: I tried scrubbing my oven after running EasyClean, but some soils still remain. What can I do?

A: The EasyClean feature works best when the soils are fully soaked and submerged in water before running the cycle and during hand-cleaning. If soils are not sufficiently soaked in water, it can negatively affect the cleaning performance. Repeat the EasyClean process using sufficient water. Sugar-based and certain greasy soils are especially hard to clean. If some stubborn soils remain, use the Self Clean feature to thoroughly clean your oven.

Troubleshooting FAQs

TROUBLESHOOTING FAQs (Cont.)

Q: Soils on my oven walls are not coming off. How can I get the oven walls clean?

A: Soils on the side and rear walls of your appliance may be more difficult to fully soak with water. Try repeating the EasyClean process with more than the ¼ cup (2 oz or 60 ml) of spray recommended.

Q: Will EasyClean get all of the soils and stains out completely?

A: It depends on the soil type. Sugar-based and certain grease stains are especially hard to clean. Also, if stains are not sufficiently soaked in water, this can negatively affect cleaning performance. If stubborn or built-up stains remain, use the Self Clean feature. Refer to the Self Clean section of your owner's manual.

Q: Are there any tricks to getting some of the stubborn soils out?

A: Scraping the soils with a plastic scraper before and during hand-cleaning is recommended. Fully saturating soils with water is also recommended. However, certain types of soils are harder to clean than others. For these stubborn soils, the Self Clean cycle is recommended. Consult the Self Clean section of your owner's manual for details.

Q: Is it safe for my convection fan or heater element to get wet during EasyClean?

A: Yes. The convection fan or heater element may get a little wet during cleaning. However, direct spray onto the broil burner and heater elements is not necessary because these are self-cleaning during regular use.

Q: Do I need to use all 1 ¼ cups (10 oz or 300 ml) of water for EasyClean?

A: Yes. It is highly recommended that 1 cup (8 oz or 240 ml) of water be sprayed or poured on the bottom and an additional ¼ cup (2 oz or 60 ml) of water be sprayed on walls and other soiled areas to fully saturate the soils for better cleaning performance.

Q: I see smoke coming out of my appliance's vents during EasyClean. Is this normal?

A: This is normal. This is not smoke. It is actually water vapor (steam) from the water in the oven cavity. As the oven heats briefly during EasyClean, the water in the cavity evaporates and escapes through the oven vents.

Q: How often should I use EasyClean?

A: EasyClean can be performed as often as you wish. EasyClean works best when your oven is LIGHTLY soiled from such things as LIGHT grease splatter and small drops of cheese. Please refer to the EasyClean section in your owner's manual for more information.

Q: What is required for EasyClean?

A: A spray bottle filled with 1¼ cups (10 oz or 300 ml) of water, a plastic scraper, a non-scratch scrubbing pad and a towel. You should not use abrasive scrubbers such as heavy-duty scouring pads or steel wool.

Q: How can I help keep children safe around the appliance?

A: Children should be supervised around the appliance whenever it is in use, and after use until surfaces have cooled. You can also use the Lock Out feature to help prevent children from accidentally turning on the oven. The Lock Out feature disables most control panel buttons. Consult the Lockout Feature section of your owner's manual for details. (In models without a Self Clean option, the Lock Out feature locks the controls but does not lock the oven door.)

Troubleshooting Tips

BEFORE CALLING FOR SERVICE

Review this section before calling for service; doing so will save you both time and money.

Cooking

Problem	Possible Cause & Solution
Arcing or Sparking	Cookware is not microwave safe. • When in doubt, test cookware before use.
	Do not operate oven while empty. • Place the food in the oven.
Unevenly Cooked Foods, Overcooked Foods, Undercooked Foods, Improper Defrosting	Carefully monitor the food in the microwave oven while it is cooking. • See the Cooking Tips in the Operating the Upper Microwave Oven section.
If the display shows a time counting down but the oven is not cooking.	The oven door is not closed. • Check that the oven door is firmly closed.
Oven will not work	Plug on appliance is not completely inserted in the electrical outlet. • Make sure electrical plug is plugged into a live, properly grounded outlet.
	A fuse in your home may be blown or the circuit breaker tripped. • Replace the fuse or reset the circuit breaker.
	Oven controls improperly set. • See the Using the Oven section.
	Oven too hot. • Allow the oven to cool to below locking temperature.
Steam is exhausted through the oven vent.	Cooking foods with high moisture produces steam. • This is normal.
Appliance does not operate.	Cord is not plugged in correctly. • Make sure cord is plugged correctly into outlet. Check circuit breakers.
	Service wiring is not complete. • Contact your electrician for assistance.
	Power outage. • Check house lights to be sure. Call your local electric company for service.
Oven smokes excessively during broiling.	Control not set properly. • Follow instructions under Changing Settings.
	Meat too close to the element. • Reposition the rack to provide proper clearance between the meat and the element. Preheat broil element for searing.
	Meat not properly prepared. • Remove excess fat from meat. Cut remaining fatty edges to prevent curling.
	Insert on broiler pan wrong side up and grease not draining. • Always place the grid on the broiler pan with ribs up and slots down to allow grease to drip into the pan.
	Grease has built up on oven surfaces. Old grease or food spatters cause excessive smoking. • Regular cleaning is necessary when broiling frequently.
Food does not bake or roast properly	Oven controls improperly set. • See the Using the Oven section.
	Rack position is incorrect or the rack is not level. • See the Using the Oven section.
	Incorrect cookware or cookware of improper size being used. • See the Using the Oven section.

Troubleshooting Tips

Cooking (Cont.)

Problem	Possible Cause & Solution
Oven temperature too hot or cold	Aluminum foil used on the broiling pan and grid has not been fitted properly and slit as recommended. <ul style="list-style-type: none"> See the Using the Oven section.
	In some areas the power voltage may be low. <ul style="list-style-type: none"> Preheat the broil element for 5-7 minutes. See the Using the Oven section.
	Oven sensor needs to be adjusted. <ul style="list-style-type: none"> See the Using the Oven section.
Food does not broil properly	Oven controls improperly set. <ul style="list-style-type: none"> Make sure you select the Broil mode properly.
	Improper rack position being used. <ul style="list-style-type: none"> See the Broiling Guide.
	Cookware not suited for broiling. <ul style="list-style-type: none"> Use broiling pan and grid.
	Aluminum foil used on the broiling pan and grid has not been fitted properly and slit as recommended. <ul style="list-style-type: none"> See the Using the Oven section.
	In some areas the power voltage may be low. <ul style="list-style-type: none"> Preheat the broil element for 5-7 minutes. See the Broiling Guide.
Excessive smoking during a Self Clean cycle	Excessive soil. <ul style="list-style-type: none"> Turn off the Self Clean function. Open the windows to rid the room of smoke. Wait until the Self Clean mode is cancelled. Wipe up the excess soil and reset the clean.
Burning or oily odor emitting from the vent	This is normal in a new oven. <ul style="list-style-type: none"> This will disappear in time. To speed the process, set a Self Clean cycle for a minimum of 3 hours. See the Self Clean section.
Moisture collects on oven window or steam comes from oven vent	This happens when cooking foods high in moisture. <ul style="list-style-type: none"> This is normal.
	Excessive moisture was used when cleaning the window. <ul style="list-style-type: none"> Do not use excessive moisture when cleaning the window.
Oven will not steam cook	Improper assembly <ul style="list-style-type: none"> Make sure to slide the tank into the slot until it clicks into place.
	The drain in the water tank may be clogged with hard water scale. <ul style="list-style-type: none"> If this happens, the descaling function must be run before the steam function can be used.
Water pools in the bottom of the oven during or after steam cooking (On some models)	During steam cooking, the water in the water tank is transferred to the bottom of the oven. <ul style="list-style-type: none"> It is normal for water to fill the bottom of the oven during or after the Steam mode. If the water leaves mineral deposits on the oven bottom, remove the deposits with a cloth or sponge soaked in vinegar.
White residue appears on the oven bottom after steam cooking	Using hard water in the water tank can result in hard water scale on the oven bottom. <ul style="list-style-type: none"> To remove mineral deposits that remain on the oven bottom, use a cloth or sponge soaked in vinegar or a weak citric acid solution.
The sous vide module beeps during operation	This alert sounds when the sous vide module is operated without water in the steam feeder tank. <ul style="list-style-type: none"> Fill the steam feeder tank to the recommended level before using

Troubleshooting Tips

Parts & Features

Problem	Possible Cause & Solution
Oven control beeps and displays any F code error.	<p>Electronic control has detected a fault condition.</p> <ul style="list-style-type: none"> • Turn off the oven function you are using to clear the display and stop beeping. Reprogram oven. If fault recurs, record fault number and call for service. <p>- [Case 1] Code: F-9 Cause: Oven not heating (upper oven)</p> <p>- [Case 2] Code: F-19 Cause: Oven not heating (lower oven)</p>
Lock icon is on in the display when you want to cook	<p>The oven door is locked because the temperature inside the oven has not dropped below the locking temperature.</p> <ul style="list-style-type: none"> • Press the STOP button. Allow the oven to cool.
Oven light does not work.	<p>It is time to replace the bulb or the bulb is loose.</p> <ul style="list-style-type: none"> • Replace or tighten bulb. See "Changing the Oven Light" section in this Owner's Manual.
Cooling fan continues to run after oven is turned off.	<p>The fan turns off automatically when the electronic components have cooled sufficiently.</p> <ul style="list-style-type: none"> • This is normal.
Oven will not Self Clean.	<p>The oven temperature is too high to set a Self Clean operation.</p> <ul style="list-style-type: none"> • Allow the appliance to cool and reset the controls.
	<p>Oven controls improperly set.</p> <ul style="list-style-type: none"> • See the Self Clean section.
	<p>A Self Clean cycle cannot be started if oven door is open.</p> <ul style="list-style-type: none"> • Close the oven door.
Oven door does not open after a Self Clean cycle	<p>Oven is too hot.</p> <ul style="list-style-type: none"> • Allow the oven to cool below locking temperature.
	<p>The control and door may be locked.</p> <ul style="list-style-type: none"> • Allow about one hour for the oven to cool after the completion of a Self Clean cycle. The door can be opened when the lock k is no longer displayed.
The oven is not clean after a Self Clean cycle	<p>Oven controls not properly set.</p> <ul style="list-style-type: none"> • See the Self Clean section.
	<p>Oven was heavily soiled.</p> <ul style="list-style-type: none"> • Clean up heavy spillovers before starting the clean cycle. Heavily soiled ovens may need to Self Clean again or for a longer period of time.
Convection fan stops	<p>Convection fan stops during a convection bake cycle. It is done to allow for more even heating during the cycle.</p> <ul style="list-style-type: none"> • This is not a failure of the range and should be considered normal operation.
Displayed Time is flashing	<p>This means that the product has just been plugged in, or that it has experienced a power interruption.</p> <ul style="list-style-type: none"> • Touch the Clock key and reset the time, or touch any key to stop the flashing.
Oven racks are difficult to slide	<p>The shiny, silver-colored racks were cleaned in a Self Clean cycle.</p> <ul style="list-style-type: none"> • Apply a small amount of vegetable oil to a paper towel and wipe the edges of the oven racks with the paper towel.

Noises

Problem	Possible Cause & Solution
“Crackling” or “popping” sound	<p>This is the sound of the metal heating and cooling during both the cooking and Self Clean functions.</p> <ul style="list-style-type: none"> • This is normal.
Fan noise	<p>A convection fan may automatically turn on and off.</p> <ul style="list-style-type: none"> • This is normal.
Steam feeder tank noise	<p>After any steam cooking cycle, the drying function will run automatically. It is normal to hear the steam pump running during the drying function.</p>

Limited Warranty

GEAppliances.com

All warranty service for your appliance is provided exclusively by GE Appliances, a Haier company's Factory Service Centers, or by a service technician authorized by GE Appliances to provide warranty service for your appliance. To schedule service online, visit us at **GEAppliances.com/service**, or call GE Appliances at 800.GE.CARES (800.432.2737). Please have your serial number and your model number available when calling for service. Service that has not been scheduled or otherwise arranged for by GE Appliances will not be covered under this warranty, including any parts and/or services provided.

Servicing your appliance may require the use of the onboard data port for diagnostics. This gives a GE Appliances factory service technician the ability to quickly diagnose any issues with your appliance and helps GE Appliances improve its products by providing GE Appliances with information on your appliance. If you do not want your appliance data to be sent to GE Appliances, please advise your technician not to submit the data to GE Appliances at the time of service.

For the period of	GE Appliances will replace
One year From the date of the original purchase	Any part of the range which fails due to a defect in materials or workmanship. During this limited one-year warranty , GE Appliances will provide, free of charge , all labor and in-home service to replace the defective part.

What GE Appliances will not cover:

- Service trips to your home to teach you how to use the product.
- Improper installation, delivery or maintenance.
- Failure of the product if it is abused, misused, modified or used for other than the intended purpose or used commercially.
- Replacement of house fuses or resetting of circuit breakers.
- Damage to the product caused by accident, fire, floods or acts of God.
- Damage to finish, such as surface rust, tarnish, or small blemishes not reported within 48 hours of delivery.
- Incidental or consequential damage caused by possible defects with this appliance.
- Damage caused after delivery.
- Product not accessible to provide required service.
- Service to repair or replace light bulbs, except for LED lamps.

EXCLUSION OF IMPLIED WARRANTIES

Your sole and exclusive remedy is product repair as provided in this Limited Warranty. Any implied warranties, including the implied warranties of merchantability or fitness for a particular purpose, are limited to one year or the shortest period allowed by law.

This limited warranty is extended to the original purchaser and any succeeding owner for products purchased for home use within the USA. If the product is located in an area where service by a GE Appliances Authorized Servicer is not available, you may be responsible for a trip charge or you may be required to bring the product to an Authorized GE Appliances Service location for service. In Alaska, the limited warranty excludes the cost of shipping or service calls to your home.

Some states do not allow the exclusion or limitation of incidental or consequential damages. This limited warranty gives you specific legal rights, and you may also have other rights which vary from state to state. To know what your legal rights are, consult your local or state consumer affairs office or your state's Attorney General.

Warrantor: GE Appliances, a Haier company

Louisville, KY 40225

Staple your receipt here. Proof of the original purchase date is needed to obtain service under the warranty.

Accessories

Looking For Something More?

GE Appliances offers a variety of accessories to improve your cooking and maintenance experiences!

Refer to the Consumer Support page for phone numbers and website information.

The following products and more are available:

Accessories

Small Broiler Pan (8 ¾" x 1 ¼" x 13 ½")

Large* Broiler Pan (12 ¾" x 1 ¼" x 16 ½")

XL** Broiler Pan (17" x 1 ¼" x 19 1/4")

Parts

Glass Tray

Metal Tray

Turntable

Oven Racks

Oven Elements

Light Bulbs

Cleaning Supplies

16 oz. Micro Bryte® Appliance Cleaner

CitruShine™ Stainless Steel Wipes

Stainless Steel Appliance Cleaner

Graphite Lubricant

*The large broiler pan does not fit in 20"/24" ranges.

**The XL broiler pan does not fit in 24" wall ovens, 27" drop ins or 20"/24" ranges

Consumer Support

GE Appliances Website

Have a question or need assistance with your appliance? Try the GE Appliances Website 24 hours a day, any day of the year! You can also shop for more great GE Appliances products and take advantage of all our on-line support services designed for your convenience. **GEAppliances.com**.

Register Your Appliance

Register your new appliance on-line at your convenience! Timely product registration will allow for enhanced communication and prompt service under the terms of your warranty, should the need arise. You may also mail in the pre-printed registration card included in the packing material. **GEAppliances.com/register**.

Schedule Service

Expert GE Appliances repair service is only one step away from your door. Get on-line and schedule your service at your convenience any day of the year. **GEAppliances.com/service** or call 800.432.2737 during normal business hours.

Parts and Accessories

Individuals qualified to service their own appliances can have parts or accessories sent directly to their homes (VISA, MasterCard and Discover cards are accepted). Order on-line today 24 hours every day.

GEApplianceparts.com or by phone at 877.959.8688 during normal business hours.

Instructions contained in this manual cover procedures to be performed by any user. Other servicing generally should be referred to qualified service personnel. Caution must be exercised, since improper servicing may cause unsafe operation.

Contact Us

If you are not satisfied with the service you receive from GE Appliances, contact us on our Website with all the details including your phone number, or write to:

General Manager, Customer Relations | GE Appliances, Appliance Park |
Louisville, KY 40225

GEAppliances.com/contact or call 800.626.2000

