











Operating and Installation Instructions Wine Conditioning Unit



To prevent accidents and machine damage, read these instructions **before** installation or use.

Contents

| | |
|---|----|
| IMPORTANT SAFETY INSTRUCTIONS | 5 |
| Caring for the environment | 15 |
| Installation | 16 |
| Installation location | 16 |
| Climate class | 17 |
| Installation notes | 18 |
| Adjoining cabinetry..... | 18 |
| Load-bearing capacity of the niche floor | 18 |
| Ventilation..... | 19 |
| Door hinge..... | 19 |
| Side-by-side | 19 |
| Installation dimensions..... | 21 |
| Position of the electrical connection | 21 |
| Dimensions when the appliance door is open (opening angle 90°/115°)..... | 24 |
| Installing the wine conditioning unit | 25 |
| Before starting..... | 25 |
| Tools required | 26 |
| Aligning the installation niche..... | 26 |
| Checking the installation niche | 27 |
| Before installation..... | 27 |
| Preparing the installation niche | 28 |
| Pushing the wine conditioning unit into the niche..... | 31 |
| Aligning the wine storage unit | 32 |
| Securing the wine conditioning unit in the niche | 35 |
| Securing the toe-kick board and cover | 35 |
| Aligning the appliance door..... | 36 |
| Limiting the opening angle of the appliance door | 39 |
| Electrical connection | 40 |
| Saving energy | 42 |
| Guide to the appliance | 44 |
| Start screen | 46 |
| Settings mode  | 47 |
| Accessories | 49 |
| Accessories supplied | 49 |
| Optional accessories..... | 49 |
| Before first use | 50 |
| Choosing the right Door Assistant (Push2Open/Pull2Open) | 50 |
| Miele@home | 50 |

| | |
|---|----|
| Operating the wine conditioning unit | 52 |
| Starting up for the first time | 53 |
| Switching the wine conditioning unit on and off | 54 |
| Switching off for longer periods of time | 55 |
| Selecting additional settings | 56 |
| Switching Keypad Lock on or off  /  | 56 |
| Performing a Self Test  | 57 |
| Switching on the Door Assistant  | 57 |
| Switching off the Door Assistant  | 59 |
| Miele@home | 60 |
| Switching off Demo Mode  | 61 |
| Resetting the settings to their default settings  | 62 |
| Switching Sabbath Mode  on or off | 64 |
| Switching Ambient Lighting  on or off | 65 |
| Selecting the Ambient Display | 66 |
| The ideal temperature and humidity | 67 |
| Temperature | 67 |
| Isolator panels for thermal separation | 68 |
| Setting the temperature | 68 |
| Humidity | 69 |
| Increasing the humidity δ | 69 |
| Door alarm | 71 |
| Storing wine bottles | 72 |
| Wooden shelves | 73 |
| Moving the wooden shelves | 73 |
| Adjusting the wooden shelves | 73 |
| Labeling the wooden shelves | 74 |
| Maximum capacity | 74 |
| SommelierSet | 75 |
| Setting up the SommelierSet | 75 |
| Automatic defrosting | 77 |
| Cleaning and care | 78 |
| Cleaning agents | 78 |
| Before cleaning the wine conditioning unit | 79 |
| Interior, accessories, and appliance door | 79 |
| Cleaning the door seal | 80 |
| Cleaning the ventilation gaps | 80 |

Contents

| | |
|---|----|
| After cleaning | 80 |
| Frequently Asked Questions | 81 |
| Causes of noises | 87 |
| Customer Service | 88 |
| Contact in the event of a fault | 88 |
| Appliance warranty and product registration | 88 |
| Declaration of conformity | 89 |
| Copyrights and licenses | 90 |

IMPORTANT SAFETY INSTRUCTIONS

This wine conditioning unit complies with all current local and national safety requirements. Inappropriate use can, however, lead to personal injury and material damage.

Read the operating and installation instructions carefully before using the wine conditioning unit. They contain important information on safety, installation, use, and maintenance. This is to protect yourself from injury, and from damaging your wine conditioning unit.

Please read and follow the instructions in the chapter on installing the wine conditioning unit, as well as the safety instructions and warnings.

Miele cannot be held liable for injury or damage caused by non-compliance with these instructions.

Keep these instructions in a safe place and pass them on to any future owner.

 Danger of injury and damage to the appliance due to the wine conditioning unit tipping over.

The wine conditioning unit is very heavy and can tip forwards when the appliance door is open.

Keep the appliance door shut until the wine conditioning unit has been built in and secured in the installation niche in accordance with the operating and installation instructions.

 Risk of injury from broken glass.

If installed at altitudes above 6,560 ft (2,000 m), there is a risk of the glass in the door breaking because of changes in air pressure. Shards of glass can cause severe injury.

IMPORTANT SAFETY INSTRUCTIONS

Appropriate use

- ▶ This wine conditioning unit is intended for use in domestic households and similar residential environments such as
 - staff kitchen areas in shops, offices and other working environments
 - farm houses and by clients in hotels, motels and other residential type environments
 - bed and breakfast type environments
 - catering and similar non-retail applications.

This wine conditioning is not intended for use outdoors, in damp environments or in places exposed to rain.

- ▶ The wine conditioning unit is intended for domestic use only for storing wine.

It must not be used for any other purpose.

- ▶ The wine conditioning unit is not suitable for storing and keeping cool medicines, blood plasma, laboratory preparations or other such materials or products. Incorrect use of the wine conditioning unit for such purposes can cause deterioration of the items stored. The wine conditioning unit is not suitable for use in areas where there is a risk of explosion.

Miele cannot be held liable for damage resulting from improper or incorrect use of the appliance.

- ▶ This wine conditioning unit may only be used by people (including children) with reduced physical, sensory or mental capabilities or lack of experience and knowledge if they are supervised while using it.

The wine conditioning unit may only be used by these people without supervision if they have been shown how to use it in a safe way and recognize and understand the consequences of incorrect operation.

IMPORTANT SAFETY INSTRUCTIONS

Safety with children

- ▶ Children near the wine conditioning unit must be supervised. Do not let children play with the wine conditioning unit.
- ▶ The wine conditioning unit door hinges can cause injury. Keep children away at all times.
- ▶ Ensure that any packing material is disposed of safely and kept out of the reach of children. **DANGER** of suffocation!

IMPORTANT SAFETY INSTRUCTIONS

Technical safety

▶ The refrigerant circuit has been checked for leaks. The wine conditioning unit complies with statutory safety requirements.



▶ This wine conditioning unit contains the coolant Isobutane (R600a), a natural gas which is environmentally friendly. The coolant does not damage the ozone layer and does not contribute to the greenhouse effect.

The use of this coolant has, however, led to a slight increase in the noise level of the appliance. In addition to the noise of the compressor, you might be able to hear the coolant flowing around the cooling circuit. Unfortunately, this cannot be avoided, but it does not affect the performance of the wine conditioning unit.

When transporting and installing the wine conditioning unit, ensure that no parts of the cooling circuit are damaged. Splashes of coolant can damage the eyes.

In the event of damage:

- Avoid open flames or anything which creates a spark.
- Disconnect the wine conditioning unit from the electricity supply.
- Ventilate the room where the wine conditioning unit is located for several minutes.
- Contact Miele Service.

▶ The more coolant there is in a wine conditioning unit, the larger the room it should be installed in. In the event of a leakage, if the wine conditioning is in a small room, there is the danger of combustible gases building up. For every 0.38 oz (11 g) of coolant at least 35.3 cubic feet (1 m³) of room space is required. The amount of coolant in the wine conditioning unit is stated on the data plate inside the wine conditioning unit.

IMPORTANT SAFETY INSTRUCTIONS

- ▶ To avoid the risk of damage to the wine conditioning unit, make sure that the connection data (fuse rating, frequency and voltage) on the data plate corresponds to the household supply. Check that this is the case before connecting the wine conditioning unit. Consult a qualified electrician if in any doubt.
- ▶ The electrical safety of the wine conditioning unit can only be guaranteed when correctly grounded. It is essential that this standard safety requirement is met. If in any doubt please have the electrical installation tested by a qualified electrician.
- ▶ Reliable and safe operation of the wine conditioning unit can only be guaranteed if it is connected to the power supply.
- ▶ The electrical outlet must not be concealed behind the wine conditioning unit and must be easily accessible so that the appliance can be quickly disconnected from the electrical supply in case of an emergency.
- ▶ If the power cord supplied is damaged, it must only be replaced by an original part to prevent a hazard for the user. Miele can only guarantee the safety of the appliance when original Miele parts are used.
- ▶ The electrical outlet must be properly grounded.
- ▶ Do not connect the appliance to the electrical supply with a power bar or extension cord. These are a fire hazard and do not guarantee the required safety of the appliance.
- ▶ If moisture gets into electrical components or into the power cord, it could cause a short circuit. Therefore, do not operate the wine conditioning in areas where there may be moisture or splashing water (e.g., garages, laundry rooms).
- ▶ This wine conditioning unit must not be used in a non-stationary location (e.g. on a ship).

IMPORTANT SAFETY INSTRUCTIONS

- ▶ In environments with a tropical climate (above approximately 90°F (32°C) and above approximately 70% humidity), the wine conditioning unit must be operated in an air-conditioned room. Otherwise, it is not possible to guarantee that the wine conditioning unit will operate without issues.
- ▶ Before installation and use check the wine conditioning unit for any visible damage. Do not operate or install a damaged appliance.
- ▶ To ensure safe operation, use the wine conditioning unit only when it has been installed.
- ▶ The wine conditioning unit must be disconnected from the power supply during installation, side-by-side heater installation, maintenance and repair work. The appliance is only disconnected from the power supply if:
 - the circuit breaker has been tripped, or
 - the power cord has been unplugged. Pull on the plug and not on the cord when removing it from the outlet.
- ▶ Installation, repair, and maintenance work should only be performed by a Miele-authorized service technician. Work by unqualified persons could be dangerous and may void the warranty.
- ▶ Repairs and other work performed by unauthorized persons could be dangerous and may void the warranty.
- ▶ Faulty components must only be replaced by genuine Miele replacement parts. Miele can only guarantee the safety standards of the appliance when Miele replacement parts are used.

Correct use

- ▶ The wine conditioning unit is designed for use within a specific climate class (room temperature range). Do not use in a climate class for which it is not designed. A lower room temperature will cause the compressor to switch off for longer periods, meaning that the wine conditioning unit is unable to maintain the required temperature.

IMPORTANT SAFETY INSTRUCTIONS

- ▶ **WARNING! DANGER** of overheating! Do not cover or block the air vents. This can impair the efficiency of the appliance, increase the power consumption and cause damage to the appliance.
- ▶ If the wine conditioning unit is used for storing food which contains fat or oil, make sure that it does not come into contact with plastic components. Any spillages of oil or fat could cause stress cracks to the plastic and cause it to break or split.
- ▶ Risk of fire and explosion. Do not store explosive materials in the wine conditioning unit or any products containing propellants (e.g., spray cans). Electrical components can cause flammable mixes of gases to ignite.
- ▶ Risk of explosion. Do not operate any electrical appliances inside the wine conditioning unit. Risk of sparking and explosion.
- ▶ Use only genuine original Miele parts. If parts or accessories from other manufacturers are used, the warranty may become invalid.

IMPORTANT SAFETY INSTRUCTIONS

Stainless steel machines:

- ▶ Adhesives will damage the coated stainless steel surface and cause it to lose its dirt-repellent protective coating. Do not use sticky notes, transparent adhesive tape, masking tape, or other types of adhesive on the stainless steel surface.
- ▶ The surface is easily scratched. Even magnets can cause scratching.

IMPORTANT SAFETY INSTRUCTIONS

Cleaning and maintenance

- ▶ Do not use any oil or grease on the door seals. They can cause the seals to deteriorate over time.
- ▶ Do not use a steam cleaning appliance to clean this wine conditioning unit. The steam could reach electrical components and cause a short circuit.
- ▶ Sharp edged or pointed objects will damage the evaporator, causing irreversible damage to the wine conditioning unit. Do not use sharp edged or pointed objects to
 - remove frost and ice,
 - remove labels, stickers, etc.

Transport

- ▶ Always transport the wine conditioning unit in an upright position and in its original transport packaging to avoid damage in transit.
- ▶ Risk of injury and damage. The wine conditioning unit is very heavy and must be transported by two people.

IMPORTANT SAFETY INSTRUCTIONS

Disposal of your old appliance

- ▶ Children could become trapped in the machine and could suffocate.
 - Remove the machine doors.
 - Leave the wooden shelves in the machine so children cannot climb inside.
- ▶ DANGER of electric shock!
 - Cut the plug off the power cord.
 - Cut the power cord off the old appliance.
- ▶ Dispose of them separately from the appliance.
- ▶ Ensure that the wine conditioning unit is not stored in the vicinity of gasoline or inflammable gases and liquids during and after disposal.
- ▶ Make sure that the coolant pipework is not damaged during disposal to avoid uncontrolled leakage of oil and coolant (see data plate for coolant type).
- ▶ Splashes of coolant can cause damage to the eyes. Be careful not to damage any part of the pipework while awaiting disposal, e.g. by
 - puncturing the coolant channels in the evaporator,
 - kinking any pipework,
 - scratching the surface coating.

Disposal of packaging material

The packaging is designed to protect the wine conditioning unit from damage during transportation. The packaging materials used are selected from materials which are environmentally friendly for disposal and should be recycled.

Ensure that any plastic wrappings, bags, etc. are disposed of safely and kept out of the reach of children. Return the packaging to your dealer.

Disposal of your old appliance

Electrical and electronic appliances contain valuable materials. They also contain certain substances, compounds and components which were essential for the proper functioning and safe use of the equipment. Handling these materials improperly by disposing of them in your household waste can be harmful to your health and the environment. Therefore, please do not dispose of your old appliance with regular household waste and follow local regulations on proper disposal.

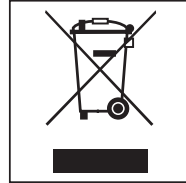

Consult with local authorities, dealers or Miele in order to dispose of and recycle electrical and electronic appliances. Miele assumes no responsibility for deleting any personal data left on the appliance being disposed.

Take care not to damage the pipework at the back of your wine conditioning unit before or during transportation to an authorized, environmentally friendly collection depot.

This way, coolant in the pipework and oil in the compressor will be contained, and will not leak into the environment.

Please ensure that your old appliance does not pose a danger to children while being stored prior to disposal. See "IMPORTANT SAFETY INSTRUCTIONS" for more information.

Installation

Installation location

This appliance should be installed in a dry, well-ventilated room.

When deciding where to install your wine conditioning unit, please bear in mind that it will use more energy if installed near to a heater, a range, or another appliance that gives off heat. Direct sunlight should also be avoided. The higher the room temperature, the longer the compressor runs and the higher the energy consumption of the wine conditioning unit is.

When installing the wine conditioning unit, please note the following:

- The electrical socket must be easily accessible in an emergency and not concealed behind the appliance.
- The plug and power cord must not touch the rear of the wine conditioning unit as they could be damaged by vibrations from the appliance.
- Do not plug in other appliances behind the wine conditioning unit.

If installation near a heat source is unavoidable, observe the following minimum distances between the appliance and the heat source:

- At least 1 1/4" (3 cm) to electric or gas stoves
- At least 11 3/4" (30 cm) to oil or coal-based stoves

If it is not possible to observe these minimum distances, an isolation plate must be installed between the Wine conditioning unit and the heat source.

Climate class

This wine storage unit is designed for use in climate class SN-T (room temperature range). Do not use in a climate class for which it is not designed.

| Climate class | Room temperature |
|---------------|---------------------------------|
| SN | 50°F to 90°F/ +10°C to +32°C |
| N | 60°F to 90°F/ +16°C to +32°C |
| ST | 60°F to 100°F/ +16 to +38°C |
| T | 60°F to 109°F/ +16 to +43°C |

A lower room temperature will cause the compressor to switch off for longer periods. This can cause the internal temperature in the wine storage unit to rise with the risk of wine deteriorating and going off.

 Risk of damage due to high humidity.

In environments with high humidity, condensation can build up on the external wine conditioning unit panels, which can cause corrosion.

Install the wine conditioning unit with sufficient ventilation in a dry and/or air-conditioned room.

After installation, make sure that the appliance door closes properly, the ventilation gaps are not covered, and the wine conditioning unit has been installed in accordance with these operating and installation instructions.

 Impaired functionality due to high humidity and high temperature. High humidity (over approx. 70%) combined with a high room temperature (over approx. 90°F/32°C) can impair the function of your wine conditioning unit.

In environments with a tropical climate, the wine conditioning unit must be operated in an air-conditioned room.

Installation

Installation notes

 Risk of damage and injury from the wine conditioning unit tipping over.

The wine conditioning unit is very heavy and can tip forwards when the appliance door is open.

Keep the appliance door shut until the wine conditioning unit has been installed and secured in its installation niche in accordance with these operating and installation instructions.

Due to its weight and size, the wine conditioning unit must be installed by two people.

Adjoining cabinetry

The wine conditioning unit is screwed to the adjoining cabinetry to the side and above. For this reason, it is essential that all of the relevant cabinetry are secured to the ground or wall.

Load-bearing capacity of the niche floor

To ensure the safe installation of the wine conditioning unit and to guarantee its correct functioning, the floor of the niche where the appliance is to be installed must be smooth and even.

It must be made from strong, rigid material.

Because the wine conditioning unit is extremely heavy when fully loaded, it is essential that the floor it stands on is able to bear its weight. If necessary, seek the advice of an architect or construction expert.

When fully loaded, the weight of the wine conditioning unit is approx.:

| | |
|--------------|----------------------|
| KWT 26x2 SF | 1545 lbs (701 kg) |
| KWT 26x2 SFS | 1556 lbs (706 kg) |

Ventilation

 Risk of fire and damage due to insufficient ventilation.

If the wine conditioning unit is not ventilated sufficiently, the compressor will run more frequently and for longer periods.

This causes increased energy consumption and an increased compressor operating temperature, which can result in damage to the compressor.

Please ensure that there is adequate ventilation around the wine conditioning unit.

It is essential to observe the required ventilation gaps. The ventilation gaps must never be obstructed.

Door hinge

 Risk of damage and injury when changing the door hinges.

Changing the door hinges single-handedly can cause damage to the appliance and injury.

The wine conditioning unit is supplied with a fixed hinge. On no account should you attempt to change the door hinge yourself.

If you need to change the door hinge to the other side, please contact the Miele Service department.

Side-by-side

This wine storage unit can be installed side-by-side with another wine storage unit or refrigeration appliance. The following overview will show you which side-by-side installation options you have with your wine storage unit.

Depending on the installation situation, you will need the side-by-side installation kit for side-by-side installation (see “Accessories – Optional accessories”).

You will also need a Top Frame (KTF) (top cover) for side-by-side installation. Both are available from your Miele dealer or the Miele Service.

Instructions for installing wine storage units/refrigeration appliances side-by-side can be found in the side-by-side installation kit installation instructions.

. . . with partition wall

The wall **a** between the side-by-side wine conditioning units/refrigeration appliances must be **at least 5/8" (16 mm)** thick.

Installation

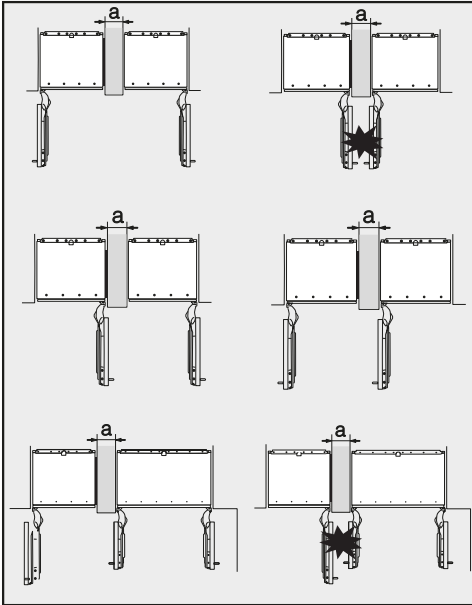

If the partition wall **a** is **narrower than 6 5/16" (160 mm)**, you will need the side panel heater from the side-by-side installation kit to prevent condensation from forming and any resulting damage.

When planning installation niches, please note that the niche into which the appliance with the side panel heater is installed must be **3/16" (4 mm)** wider (see "Installation – Installation dimensions").

If the partition wall **a** is **thicker than 6 5/16" (160 mm)**, you do not need the side-by-side installation kit, nor the side panel heater.

... without partition wall

If the door hinges of the appliances are next to each other, you must take into account the thickness of the cabinet fronts and door handles so that the appliance doors do not collide and become damaged if they are opened at the same time.

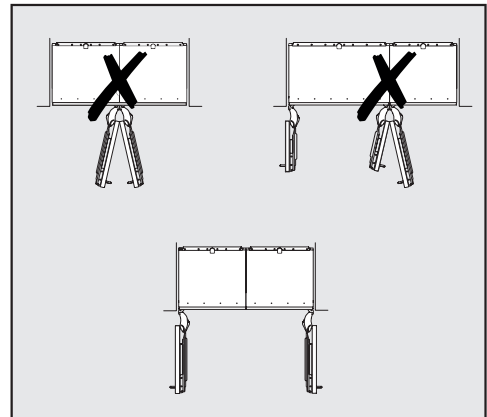

The wine conditioning units/refrigeration appliances are secured individually in their installation niche using the supplied installation material.

If the wine conditioning unit/appliances are to be installed next to each other without a partition wall between them, they will need to be joined together with the side-by-side merging kit. In addition, you must install the heating mat to prevent condensation from forming and any resulting damage.

Installation dimensions

Position of the electrical connection

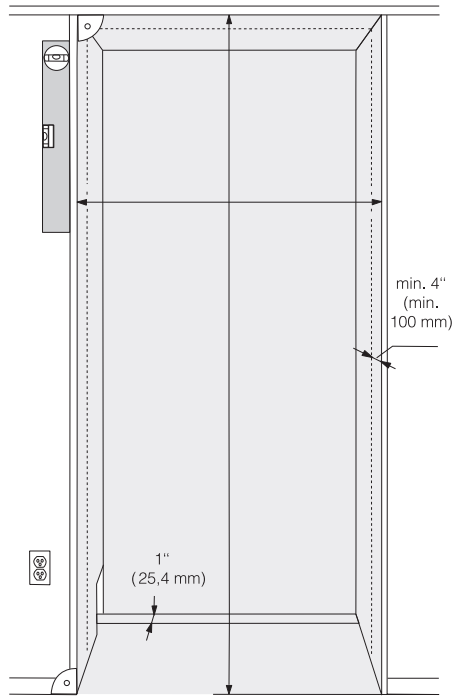

- The electrical connection must not be positioned higher than 9" (228 mm) above the floor.

The electrical socket must not be concealed behind the appliance and must be easily accessible in an emergency.

Installation

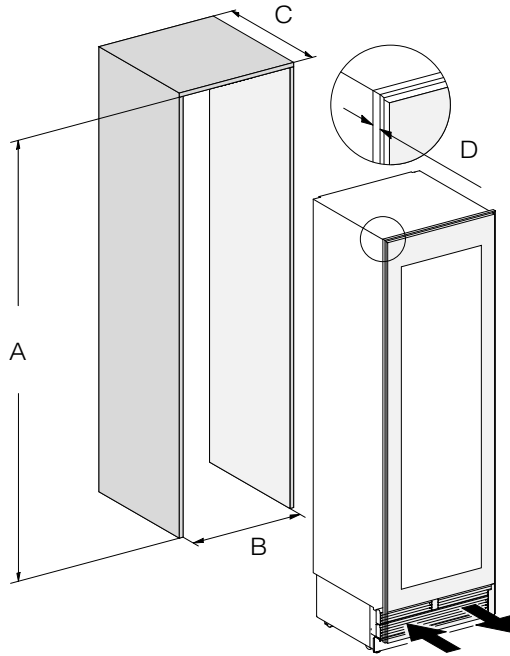

| | A | B | C | D |
|----------------|--------------------------------------|--------------|--------------|--------------|
| KWT 26x2 SF(S) | 84"–85 3/16" (2,134– 2,164 mm) | 24" (610 mm) | 24" (610 mm) | 3/4" (19 mm) |

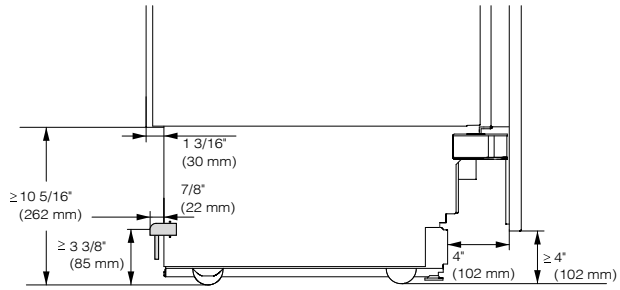

Side view

Installation

Dimensions when the appliance door is open (opening angle 90°/115°)

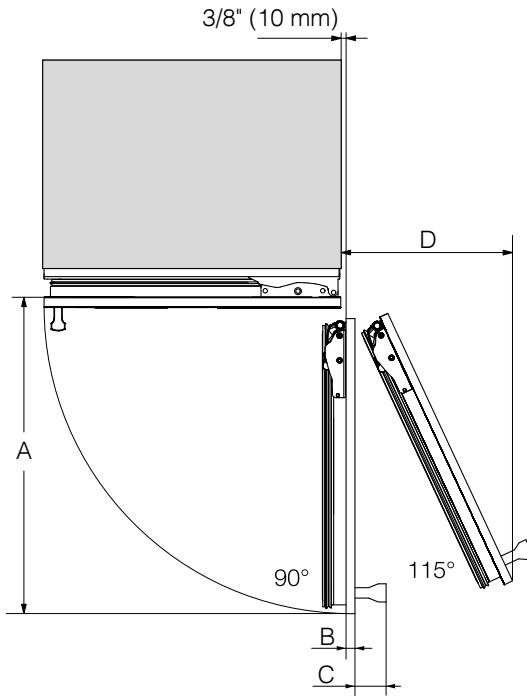

| A | B | C | D |
|------------------|---------------|-------------|------------------|
| 26 5/8" (677 mm) | Cabinet front | Door handle | 11 5/8" (296 mm) |

Installing the wine conditioning unit

Before starting...

It is essential to read these installation instructions carefully before starting to install the wine conditioning unit.

The wine conditioning unit should be installed by a suitably qualified tradesman in accordance with these installation instructions. Safe operation of the wine conditioning unit is only assured if it has been installed and connected in accordance with the installation instructions.

 **DANGER** of damage and injury!

The wine conditioning unit is very heavy and can tip forwards when the appliance door is open.

Keep the door shut until the wine conditioning unit has been built in and secured in its installation niche in accordance with the operating and installation instructions.

The wine conditioning unit is both large and heavy. Installation must be carried out by two people.

The wine conditioning unit must be installed in accordance with local regulations. If local regulations are not available, the following regulations must be observed:

- in the USA: the National Electrical Code, ANSI/NFPA 70 – latest edition/ State and Municipal codes and/or local codes.

- in Canada: the Canadian Electrical Code C22.1 – latest edition/Provincial and Municipal codes and/or local codes.

Installation

Tools required

- Cordless drill
- TX 20 screwdriver
- Hammer drill
- Drill bits in various sizes, depending on materials
- Hammer
- Open-ended wrench
- Ratchet wrench, attachment: socket, 5/16" (8 mm)
- Adhesive tape
- Utility knife
- Pipe wrench
- Level
- Tape measure
- Pencil

Other

- Step ladder
- Hand truck

Aligning the installation niche

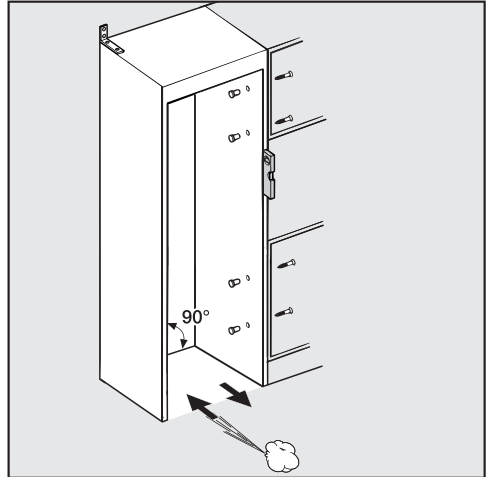

The installation niche must be carefully aligned using a bubble level before installing the wine conditioning unit. The niche corners must be at 90° angles to each other, otherwise the cabinet front will not sit straight on all 4 corners of the installation niche.

Checking the installation niche

- Check the installation dimensions (see “Installation – Installation dimensions”).
- Check the position of the electrical connection. The length of the power cord is 9' 10" (3 m).

The electrical socket must not be concealed behind the appliance and must be easily accessible in an emergency.

- Check the surroundings for possible collisions (see “Installation – Dimensions with appliance door open”).
- Only install the wine storage unit in stable, solid installation niches, positioned on an even and level floor.
- Also check the installation niche for the following criteria:
 - The side panels of the installation niche must be even.
 - The surrounding walls of the installation niche must be at least 5/8" (16 mm) thick.
 - The surrounding walls must be securely fixed to the floor or wall.
 - Shortened side walls must be at least 4" (100 mm) deep.

Before installation

- Before installation, remove any accessories from the back of the appliance.
- Check the wine storage unit for damage during transportation.

Do not install the wine storage unit if it is damaged.

- Check that all parts at the back of the appliance are unhindered.
- To protect the floor during installation, secure an off-cut of flooring or similar material to the floor in front of the installation area.

 Risk of damage and injury due to the refrigeration appliance tipping over.

As soon as you unscrew the brackets that fix the wine storage unit to the pallet, the appliance is no longer secured.

The wine storage unit is both large and heavy. **Installation must be carried out by two people.**

Installation

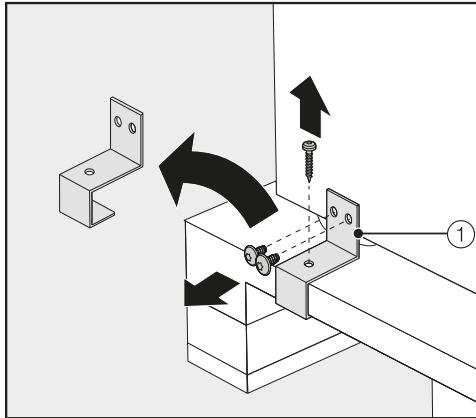

- Unscrew the fixing brackets ①.
- With the help of several people as required, carefully lift the wine storage unit from the pallet, starting with the back of the appliance.

⚠ Risk of damaging the floor from the load.

Moving the wine storage unit can cause damage to the floor. Move the wine storage unit carefully on floors that are sensitive to scratching.

As soon as you have set the wine storage unit upright, you can move it using the rollers on the bottom.

Preparing the installation niche

⚠ Risk of damage and injury from the wine storage unit tipping over.

This wine storage unit is very heavy and can tip forward when the doors are open.

The installation niche must be secured to the wall behind it and/or above it with several screws. Only this can ensure that the wine storage unit will not tip over after being installed in the installation niche.

In addition, use the provided anti-tip brackets to secure the installation niche.

Parts required for installation of the wine storage unit are supplied with the wine storage unit. The plastic bags supplied are marked with letters for easy identification.

- When performing the individual assembly steps, observe the letters specified and use the matching plastic bag with the required installation equipment.

The anti-tip brackets prevent the wine storage unit from tipping.

The anti-tip brackets are also used to fix the installation niche securely to the surrounding walls.

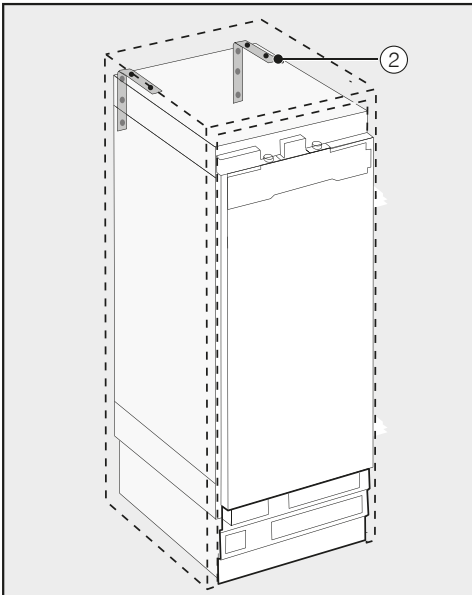

- Use 2 anti-tip brackets ② for each individual wine storage unit or 4 anti-tip brackets for each (side-by-side) combination of 2 appliances.
- Position the anti-tip brackets ② on the left and right of the niche.

Depending on the subsequent adjustment of the feet, the anti-tip brackets are positioned 84"-85 3/16" (2,134–2,164 mm) from the floor of the niche.

 Danger of injury and damage to the appliance due to the wine storage unit tipping over.

If the anti-tip brackets are fixed too high up, they cannot be used to secure the wine storage unit.

The distance between the anti-tip brackets and the wine storage unit must not exceed 5/16" (8 mm).

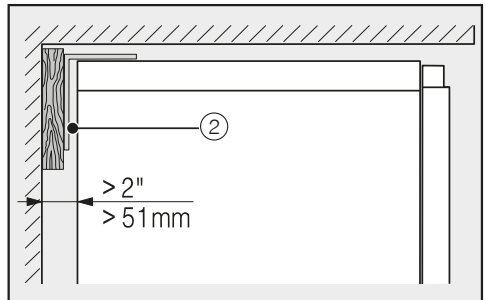
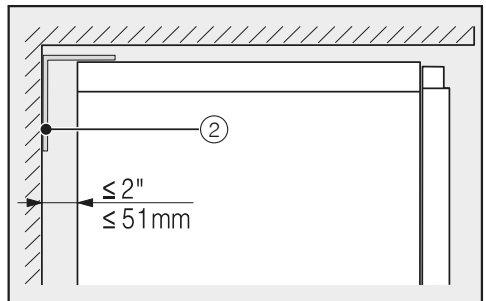

- Make sure that the gap between the wine storage unit's rear wall and the installation niche does not exceed 2" (51 mm).
- Place a wooden wedge behind the anti-tip brackets ② if necessary.
- While holding the anti-tip brackets in place, mark the necessary drill holes on the rear wall of the installation niche.

Installation

B

Retaining screws for different uses and types of material are supplied in the accompanying pack:

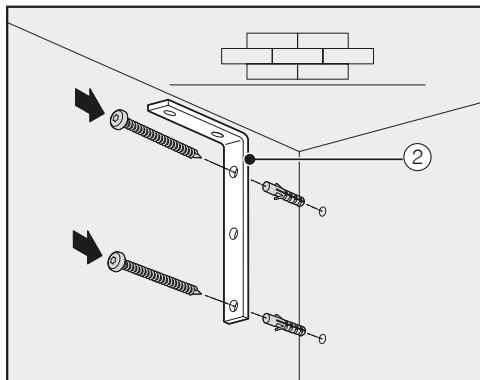

Securing to a concrete wall

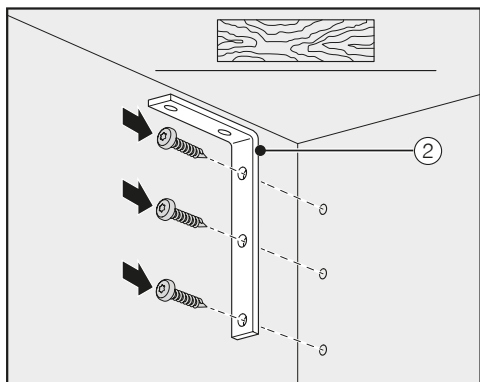

Securing to a wooden wall

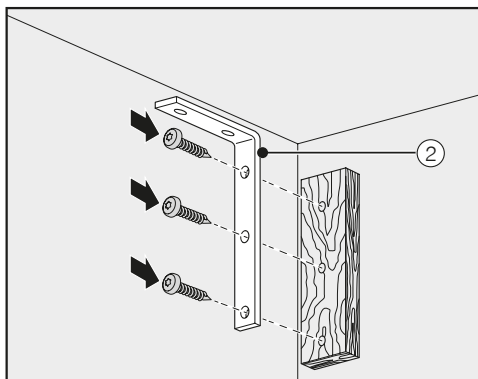

Securing with a wooden wedge

- Secure the installation niche to the wall behind it and/or above it as required using the anti-tip brackets (2).

Pushing the wine conditioning unit into the niche

Then push the wine conditioning unit into the niche, taking care not to damage the electrical cord.

If you are installing two wine storage units or a wine storage unit and another refrigeration appliance side by side, now secure the appliances to one another (see the instructions for the side-by-side installation kit).

- To ensure that the wine storage unit can then be aligned correctly, the toe-kick ventilation grille must be removed from the appliance toe-kick:

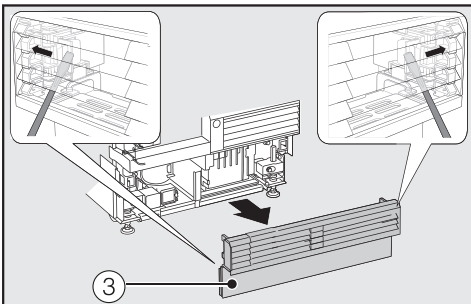

- Carefully guide a flat-head screwdriver through the toe-kick ventilation grille ③ on both sides and use it to push the internal plastic latches outward to release the toe-kick ventilation grille.
- Place the toe-kick ventilation grille to one side.

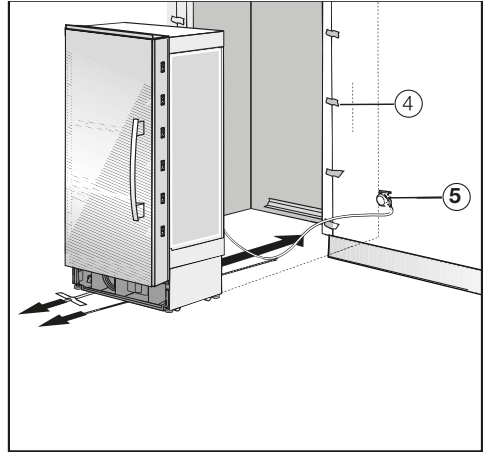

- Affix edge protection ④ to the adjacent cabinet fronts.
- Insert the plug connector at the back of the wine storage unit (see “Installation – Electrical connection”).
- Insert the plug ⑤ into the electrical socket.

The electrical socket must be close to the refrigeration appliance and easily accessible.

⚠ Risk of damage due to electrical overload.

If the wine storage unit is electrically overloaded, this can cause a short circuit and thus damage your wine storage unit.

When you install appliances side by side, each refrigeration appliance must have its own separate electrical socket.

Installation

Tip: Secure the power cord to prevent it becoming caught: tie a piece of string to the middle of the cord and as the wine storage unit is being pushed into the niche, pull the cord forward underneath the wine storage unit.

- Push the wine storage unit carefully into the installation niche.
- If the wine storage unit cannot be pushed into the niche because the floor is uneven, for example, unscrew the rear feet slightly (see “Installation – Aligning the wine storage unit”) and push the wine storage unit into the niche.
- Remove the edge protection ④ from the adjacent cabinet fronts.

Aligning the wine storage unit

- Align the wine storage unit with adjacent cabinet fronts as described below.

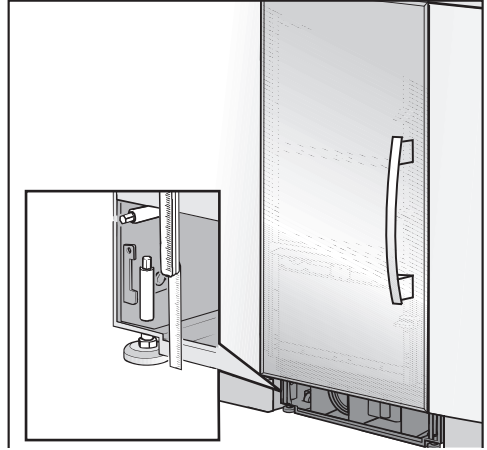

The adjustable feet at the front and back of the appliance can all be adjusted from the front of the appliance.

⚠ Risk of damage due to incorrect feet adjustment.
You may damage the adjustable feet if you use a cordless screwdriver.
Always adjust the front and rear feet by hand.

A

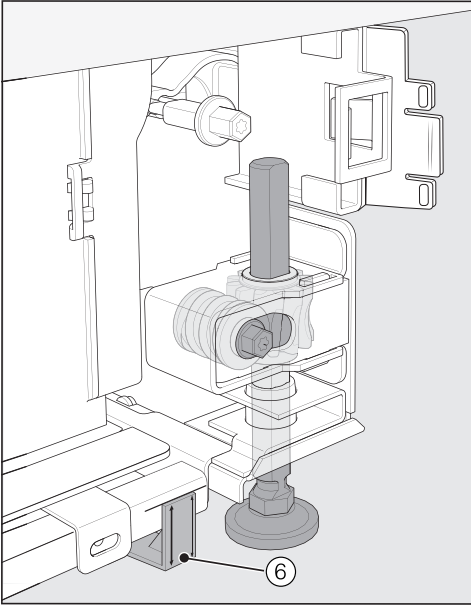

- Position the supplied spacers ⑥ on both sides on the markings next to the adjustable feet at the front of the wine storage unit.

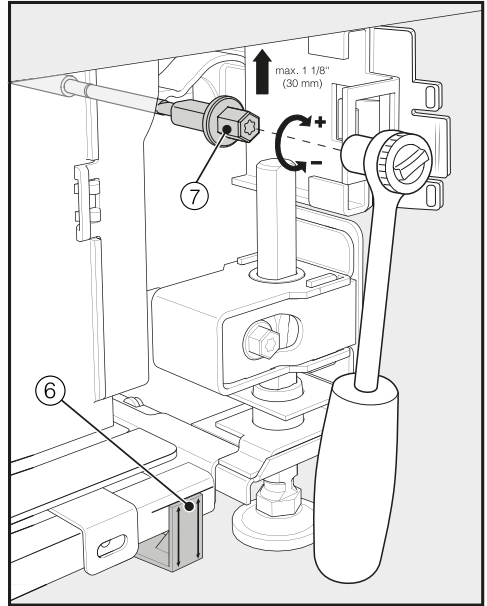

- Adjust the front feet with a ratchet (attachment: 5/16" (8 mm) socket) or a TX 20 screwdriver ⑦.

Installation

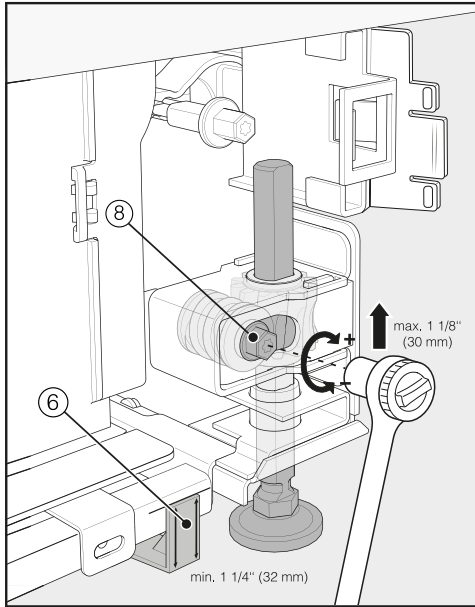

- Adjust the front feet with a ratchet (attachment: 5/16" (8 mm) socket) or a TX 20 screwdriver ⑧.

Tip: Proceed carefully when adjusting the feet, alternating between the left and right feet.

- Unscrew the feet ⑦ and ⑧ on both sides at least until the marking on the toe-kick is aligned with the required 1 1/4" (32 mm) on the spacer ⑥. The standard dimension of 1 1/4" (32 mm) relates to a niche height of 84" (2,134 mm).

It is important to align the feet to a height of at least 1 1/4" (32 mm) so that the wine storage unit's ventilation works properly via the toe-kick.

⚠ Risk of damage if the feet are adjusted too much.

The rear adjustable feet can be damaged.

Unscrew the feet **only until** the marking on the toe-kick is aligned to a maximum of 2 7/16" (62 mm) (max. niche height of 85 3/16" (2,164 mm)).

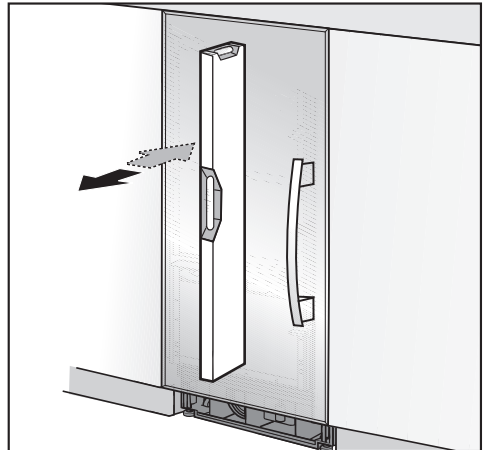

- Check the alignment of the wine storage unit again using the level.

Securing the wine conditioning unit in the niche

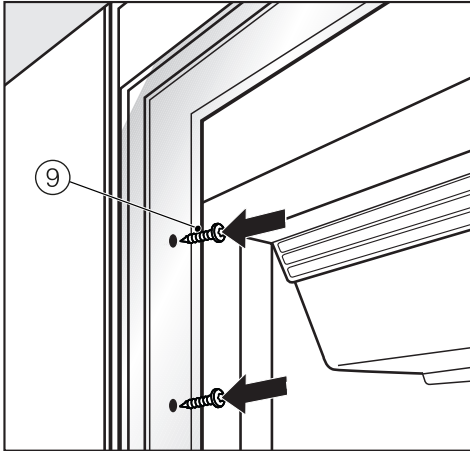

- Use the screws supplied to secure the wine storage unit on both sides.

In a side-by-side combination, only the external panels of the two appliances can be secured to the cabinet wall.

Securing the toe-kick board and cover

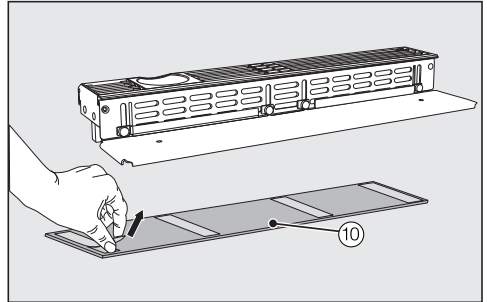

- Remove the film from the adhesive strips on the toe-kick cover provided **10**.

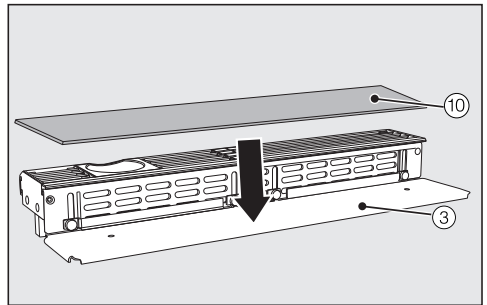

- Secure the toe-kick cover **10** to the toe-kick board **3**.

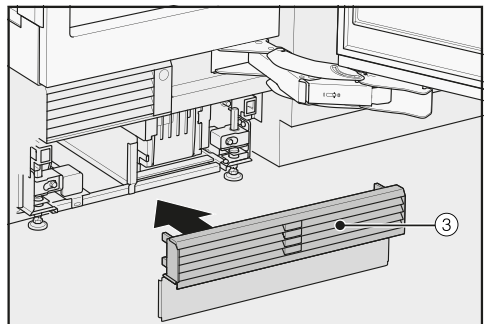

- Click the toe-kick board **3** onto the bottom of the appliance toe-kick.

Installation

Aligning the appliance door

Following installation, align the appliance door with adjacent cabinet fronts.

To do this, check the gaps to the adjacent cabinet fronts.

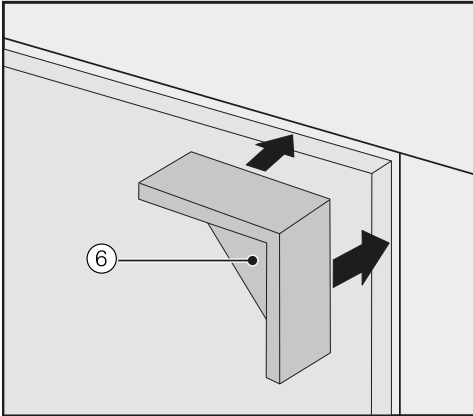

- If necessary, use the spacers provided ⑥ and place them on both sides of the appliance door at the top.

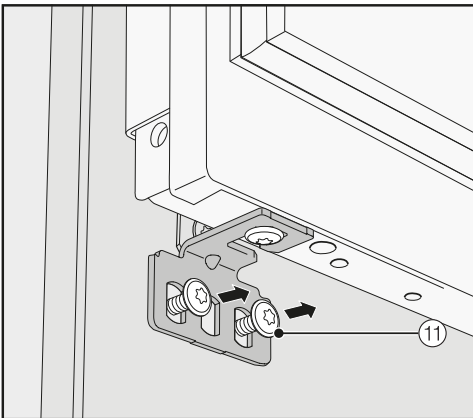

- Slightly loosen the screws ⑪ on the fixing bracket.

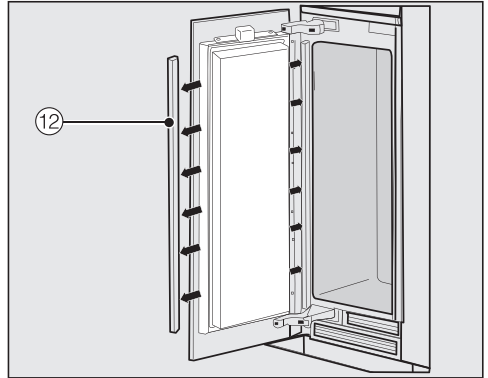

- Remove the covers ⑫ from both sides of the appliance door.

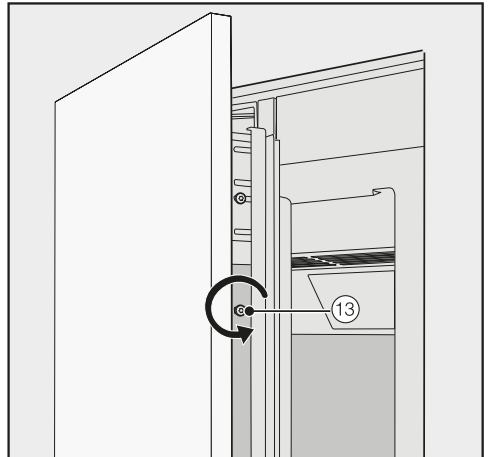

- Slightly loosen the screws ⑬ in the angle trims on both sides.

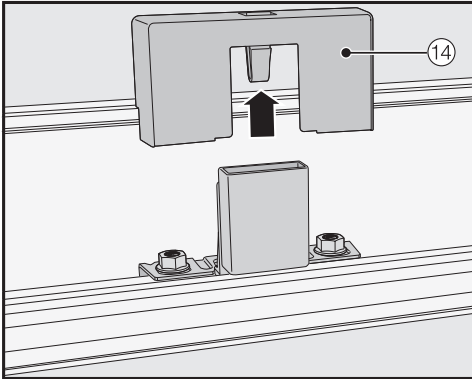

- Remove the cover 14 from the light contact switch.

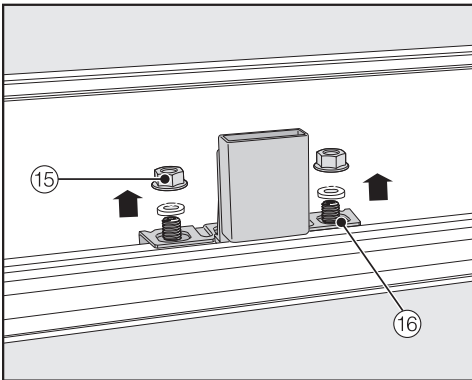

- Remove the nuts 15 and washers from the threaded bolts 16.

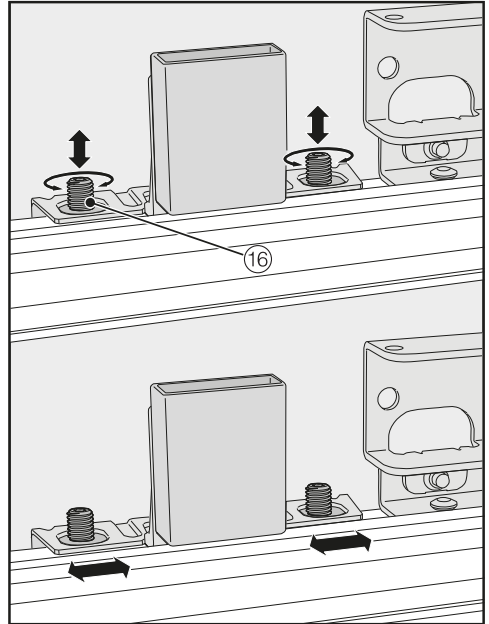

- Align the height and sides of the appliance door using the threaded bolts 16.

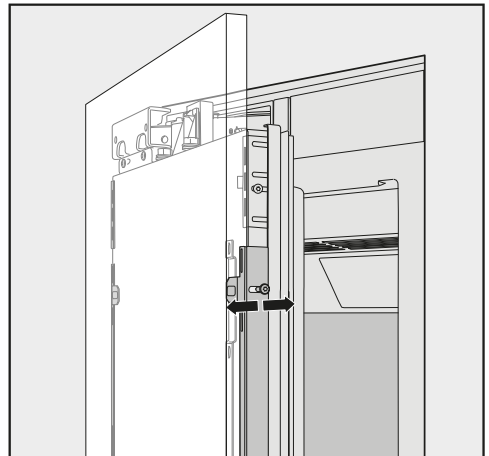

- If necessary, also align the depth of the appliance door via the gaps in the angle trims.

Installation

- Close the appliance door and check the distance between the door and adjacent cabinet fronts again.
- Then re-tighten all screws ⑪ and ⑬.

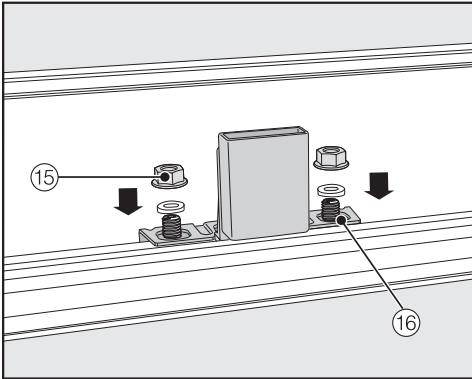

- Place the washers and nuts ⑮ back on the threaded bolts ⑯ and tighten the nuts. The appliance door is now secured.
- Reattach covers ⑫ and ⑭.

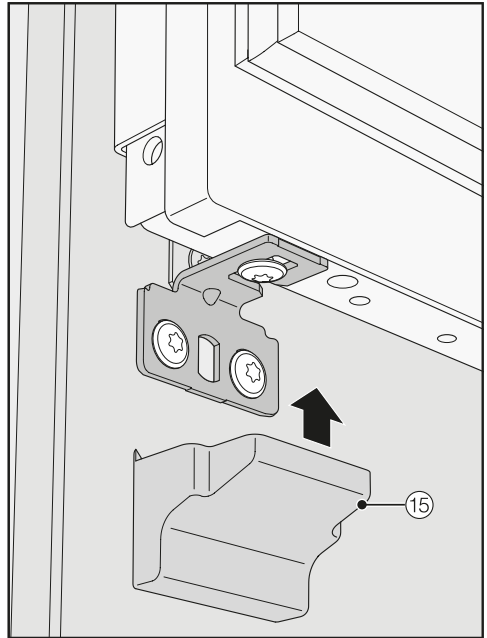

- Place the covers provided ⑮ on the fixing brackets.
- Remove the spacers ⑥ from the appliance door.

Limiting the opening angle of the appliance door



The door hinges are set ex works to enable the appliance door to be opened wide.

If, for example, the appliance door hits an adjacent wall when it is opened, you should limit the opening angle of the appliance door to 90°:

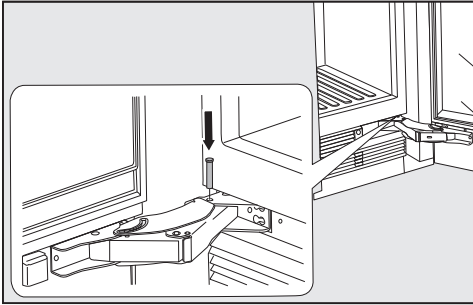

- Open the appliance door.
- Insert the pin into the lower hinge from above.

This will limit the opening angle of the appliance door to 90°.

Installation

Electrical connection

 Risk of electric shock!

The wine conditioning unit must only be switched on when it has been installed in accordance with the installation instructions.

Ground the wine conditioning unit.

The wine conditioning unit must not be grounded via a gas pipe.

If in doubt, have a suitably qualified and experienced electrician check that the wine conditioning unit complies with relevant regulations.

Do not install a fuse into neutral current or grounding electrical circuit.

Do not use an extension cord or power bar.

Do not use a frayed or damaged power cord.

 Risk of electric shock!

For protection against electric shock, this wine conditioning unit is equipped with a pole-free plug which is protected against reverse polarity. The plug must be grounded in the usual way.

Do not remove the round grounding connector pin from the plug.

Use only a grounded plug adapter.

Wait for 1 hour after installation before plugging the wine conditioning unit into the power supply. This allows coolant and refrigerator oil to settle in accordance with regulations.

Ensure that the voltage of the power supply corresponds to the connection voltage of the wine conditioning unit. A power supply of 110–120 V, 60 Hz and 10–16 Amps, which is protected by a power switch or a fuse, is required to operate the wine conditioning unit.

The manufacturer recommends operating the wine conditioning unit on a separate circuit to avoid overloading the electrical circuit.

All relevant legal electrical, fire, and building regulations must be observed when installing the outlet and/or the wine conditioning unit.

In certain countries, wine conditioning units are required to be connected to the electrical supply via a wall-mounted ON/OFF switch.

To avoid the risk of fire, electric shock, or other injuries, the wine conditioning unit must be installed and connected by a suitably qualified electrician in accordance with all relevant local and national regulations and standards, including fire prevention.

The outlet must be easily accessible so that the wine conditioning unit can be quickly disconnected from the electrical supply in case of an emergency.

If the outlet is no longer accessible after installation, an additional means of disconnection must be provided for all poles. Suitable means of disconnection include switches with an all-pole contact gap of at least 1/8" (3 mm). These can be circuit breakers, fuses, and relays.

The plug and power cord must not come into contact with the back of the wine conditioning unit as vibrations can cause damage to these components. This could result in a short circuit.

Do not plug in other appliances behind the wine conditioning unit.

Do not connect the wine conditioning unit to a stand-alone inverter such as those used with an autonomous energy source; for example, **solar power**.

When the wine conditioning unit is switched on, power surges could result in a safety switch-off. The electronic unit could be damaged. The wine conditioning unit must not be used with what are known as **energy-saving devices** either. These reduce the amount of energy supplied to the unit, causing it to overheat.

If the power cord needs to be replaced, this must be done by a qualified technician.

Connecting the wine storage unit

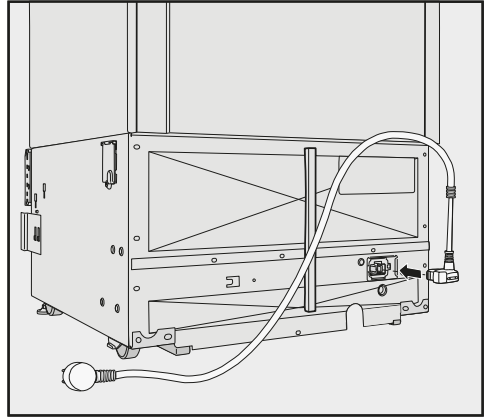

- Insert the electrical plug into the back of the wine storage unit.

Make sure that the electrical plug has clicked into position correctly.

- Insert the wine storage unit's plug into the electrical socket.

Saving energy

| | Normal energy consumption | Increased energy consumption |
|-----------------------------------|--|--|
| Installation / Maintenance | In a well-ventilated room. | In an enclosed, poorly ventilated room. |
| | Protected from direct sunlight. | In direct sunlight. |
| | Away from heat sources (radiator, range/oven). | Near a heat source (radiator, oven). |
| | Where the ideal room temperature is approx. 68°F (20°C). | Where the ambient room temperature is above 77°F (25°C). |
| | Air vents uncovered and dusted regularly. | Where the ventilation openings are blocked and full of dust. |
| Temperature setting | 50° to 54°F / 10° to 12°C | The lower the temperature in the appliance, the higher the energy consumption. |

Saving energy

| | Normal energy consumption | Increased energy consumption |
|------------|--|---|
| Use | Wooden shelves arranged as they were when the appliance was delivered. | |
| | Only open the door when necessary and for as short a time as possible. Store wine bottles in an organized way. | Frequent opening of the door for long periods will cause a loss of coldness. The wine conditioning unit works harder to cool down and the compressor runs for longer periods. |
| | Do not overfill the appliance in order to allow the air to circulate. | Poor air circulation will cause a loss of coldness. |

Guide to the appliance

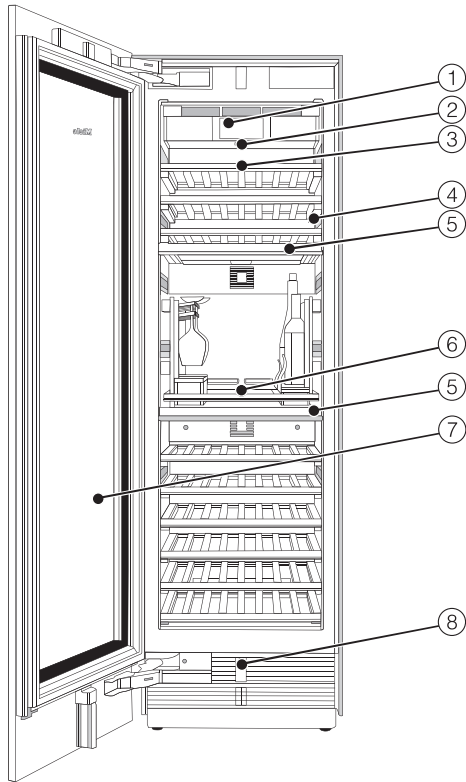

- ① Display
- ② On/Off switch
- ③ Wooden shelves with labels
- ④ Interior lighting
- ⑤ Isolator plate for thermal separation of the wine conditioning zones
- ⑥ SommelierSet*
- ⑦ Glass door with UV filter
- ⑧ Automatic door opening (Push2open/Pull2open)

*** The SommelierSet consists of:**

A glass holder, a bottle holder, 2 accessory boxes, and a decanter plate. The SommelierSet also includes felt inserts in various sizes.

Guide to the appliance



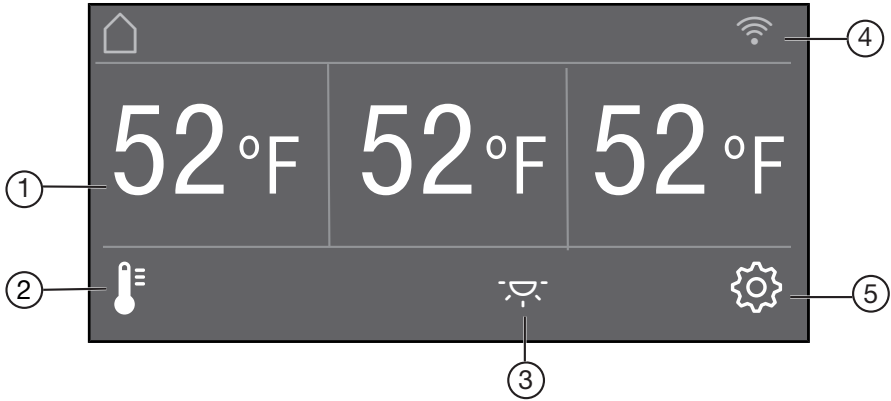





Start screen







- ① Temperature display (target temperature) for the three wine conditioning zones
- ② 🌡️ sensor
For setting the temperature and humidity Δ
- ③ 🌞 sensor control
For switching the interior lighting on and off when the appliance door is closed (ambient lighting)
- ④ Display for Miele@home connection status
(only visible when the Miele@home function has been set up)
- ⑤ Settings mode sensor control ⚙️
for adjusting various settings in Settings mode

Settings mode





In Settings mode, you can select the following appliance functions and alter their settings to some extent:

| Symbol | | Function |
|---|--------------------|--|
|  | Language | Set |
|  | Display Brightness | Adjust (darker to brighter) |
|  | Color Scheme | Set (dark or bright) |
|  | Buzzer Tones | Adjust the volume or switch off the Buzzer Tones completely (e.g., for the door alarm) |
|  | Keypad Tone | Adjust the volume or switch off the Keypad Tone completely |
| °F / °C | Temperature Unit | Set (°Fahrenheit or °Celsius) |
|  | Keypad Lock | Switch on or off (see “Selecting additional settings”) |
|  | Self Test | The system restarts and is checked for faults or malfunctions (see “Selecting additional settings”) |
|  | Door Assistant | Switch on (Push2Open or Pull2Open) or switch off (see “Selecting additional settings”) |
| @ | Miele@home | Set up, deactivate, or query WiFi connection status (see “Selecting additional settings”) |
|  | Demo Mode | Switch off * (only visible when Demo Mode, is switched on see “Selecting additional settings”) |

Guide to the appliance

| | | |
|--|------------------|--|
|  | Factory Default | Reset to default settings (see “Selecting additional settings”) |
|  | Ambient Lighting | Choose between 5 different settings for ambient lighting (see “Selecting additional settings”) |
|  | Ambient Display | Set the appearance of the display when the door is closed (see “Selecting additional settings”) |
|  | Sabbath Mode | Switch on or off (see “Selecting additional settings”) |

Symbols in settings mode

| | |
|--|---|
|  | Scroll in settings mode or select a setting |
|  | Change a setting (e.g., display brightness) |
|  | Confirm a setting |
|  | Exit the menu level |

Accessories supplied

Appliance plug

Chalk

Use the chalk supplied to write on the magnetic strips on the wooden shelves for easy identification of the wines in storage.

Toe-kick cover in stainless steel look

The toe-kick cover in stainless steel look ensures a uniform stainless steel appearance.

Optional accessories

A range of useful Miele accessories and care products are available for your wine conditioning unit.

Side-by-side installation kit and Top Frame

To install two or more wine storage units/refrigeration appliances next to one another, you will need the side-by-side installation kit (see “Installation – Side-by-side”).

You also need a cover (Top Frame KTF) to connect the wine storage units/refrigeration appliances and to cover the gap above the tops of the appliances.

Hinge pocket

If the door hinging needs to be changed on your wine conditioning unit, the upper toe-kick ventilation grille must be converted. A new hinge pocket is required in order to do this.

The door hinging must only be replaced by Miele Service.

Optional accessories are available from Miele, your Miele dealer or online via the Miele website.

Before first use

Before first use

Allow the wine conditioning unit to stand for approx. 1 hour prior to connecting it to the power supply. This will help prevent any malfunctions.

Packaging material

- Remove all packaging material from the inside of the wine conditioning unit.

Always remove all packaging material, including adhesive tape, **before** switching on the wine conditioning unit. The adhesive tape is difficult to remove from cold surfaces.

Remove the protective film from the outside (depending on model)

The wine storage unit is covered with protective film to protect it during transportation.

- Do not remove the film until the wine storage unit has been installed in its final location.

Cleaning

Please refer to the relevant instructions in “Cleaning and care”.

- Clean the inside of the wine conditioning unit and the accessories.

Choosing the right Door Assistant (Push2Open/Pull2Open)

The Door Assistant helps you to open the appliance door.

You can choose between the two Door Assistants Push2Open and Pull2Open (see “Selecting additional settings – Switching on the Door Assistant []”).

The default Door Assistant is Push2Open.

- Select the Pull2Open Door Assistant if your wine conditioning unit has a cabinet front with a handle.
- Select the Push2Open Door Assistant if your wine conditioning unit has a handle-free cabinet front.

Using the SommelierSet

- “The SommelierSet” describes how to use the SommelierSet.

Miele@home

Your wine storage unit is equipped with an integrated WiFi module.

Networking is deactivated at the factory.

To use this feature, you will need:

- a WiFi network
- the Miele app
- a Miele user account You can create a user account via the Miele app.

The Miele app will guide you as you connect your wine storage unit to your home WiFi network.

Once your wine storage unit is connected to your WiFi network you can use the app to carry out the following activities, for example:

- Call up information on the operating status of your wine storage unit
- Change the settings on your wine storage unit

Connecting your wine storage unit to your WiFi network will increase energy consumption, even when the wine storage unit is switched off.

Make sure that the signal of your WiFi network is strong in the place where you want to set up your wine storage unit.

Availability of the WiFi connection

The WiFi connection shares a frequency range with other appliances (including microwave ovens and remote control toys). This can cause sporadic or even complete connection failures. Therefore, the availability of featured functions cannot be guaranteed.

Miele@home availability

The ability to use the Miele app depends on the availability of the Miele@home service in your country.

The Miele@home service is not available in every country.

For information about availability, please visit www.miele.com.

Miele App

The Miele App is available to download free of charge from the Apple App Store® or from the Google Play Store™.



Before first use

Operating the wine conditioning unit

The touch display can be scratched by pointed or sharp objects, e.g., pens.

Only touch the display with your fingers.

If your fingers are cold, the touch display may not react.

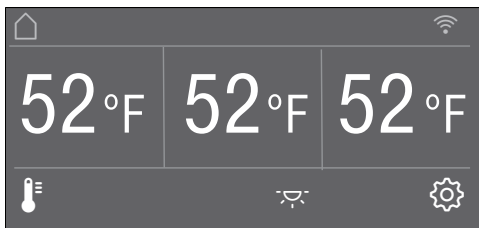

The sensor controls underneath the temperature display can be **selected** directly by touch; the symbols and text in or above the temperature display can only be **displayed**.

Settings mode

In Settings mode , you can select different wine conditioning unit functions and alter their settings to some extent (see “Selecting additional settings”).

- Touch the  sensor control to open Settings mode.
- Use the < and > sensor controls to select the function for which you wish to adjust the settings.
- Confirm your selection with *OK*.
- Adjust the settings using either the < and > sensor controls or the + and – sensor controls.
- Confirm your selection with *OK*.

The setting with the **colored** background is always the **selected** setting; it can be confirmed directly with *OK*.

- Touch the  sensor control if you wish to switch to the previous menu level or terminate the process.

Every touch of the display is confirmed with an audible keypad tone. You can switch off this keypad tone in Settings mode .

Starting up for the first time

- Open the appliance door.

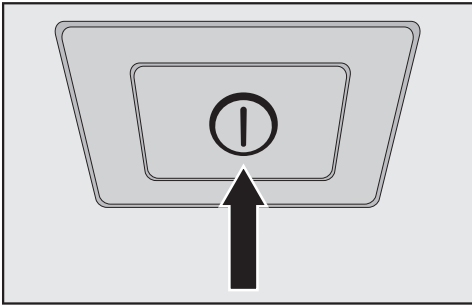



- Switch the wine storage unit on by pressing the On/Off switch.

The On/Off switch is located below the display.

The wine storage unit will start to cool and the interior lighting will come on when the appliance door is opened.

Miele will appear in the wine storage unit display.

- When you switch the wine storage unit on for the first time, you will be asked to complete the following settings:
 - Set the Language (if you accidentally select the wrong Language, return to Settings mode  and use the  symbol to change the language)
 - Set the Temperature Unit: °C (degrees Celsius) or °F (degrees Fahrenheit)
 - Set up Miele@home:
- Select Continue if you would like to set up Miele@home now. You will then be guided by the display and the Miele app.

As soon as your wine storage unit has been integrated into your WiFi network via the app, the message **Connection successful** will appear on your wine storage unit's display.

- Confirm the process with *OK* again.

If the WiFi connection is active,  will appear in the display.

- Select *Skip* if you would prefer to set up Miele@home later.
- Touch the  sensor control if you want to return to the previous menu level.

Set-up Successful will appear in the display.

- Confirm the initial start-up with *OK*.

The main screen will appear on the display (see “Appliance description – Main screen”).

You cannot terminate the initial start-up process. The only way to terminate the process is to switch off the wine storage unit, though the process will continue when the appliance is switched back on.

Switching the wine conditioning unit on and off

Switching the wine storage unit on

- Open the appliance door.
- Switch the wine storage unit on by pressing the On/Off switch.

The wine storage unit will start to cool and the interior lighting will come on when the appliance door is opened.

Miele will appear, followed by the main screen on the wine storage unit display:

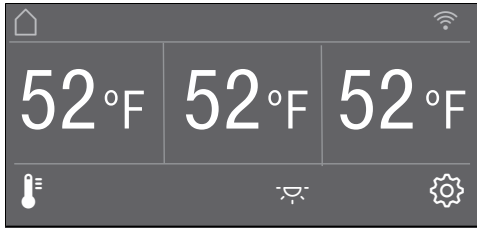

⚠ Risk of damage due to high humidity.

In environments with high humidity, condensation can build up on the external wine storage unit panels. This condensation can cause corrosion and lead to damage on external appliance panels.

Install the wine storage unit with sufficient ventilation in a dry and/or air-conditioned room.

Do not switch the wine storage unit on if you are going to be away for a long period of time.

Do not leave the wine storage unit unattended for a long period of time while it is switched on.

Switching the wine storage unit off

- Switch the wine storage unit off by pressing the On/Off switch.

The cooling and interior lighting are switched off.

Please note: the wine storage unit is not disconnected from the power supply when it is switched off with the On/Off switch.

Switching the wine conditioning unit on and off

Switching off for longer periods of time

If the wine storage unit is not going to be used for a longer period of time:

- Switch the wine storage unit off.
- Unplug the appliance or switch off the breaker.
- Clean the wine storage unit.
- Leave the door to the wine storage unit ajar to enable air to circulate and to avoid odors building up inside it.

If, during a long absence, the wine storage unit is switched off but not cleaned and the door(s) left shut, there is a danger of bacteria building up inside the appliance.

The wine storage unit must be cleaned.

Selecting additional settings

In Settings mode , you can select different wine conditioning unit functions and alter their settings to some extent, allowing you to adjust the appliance to suit your requirements.

Only the functions in Settings mode  that require further explanation are described below.

The door alarm and other warnings are automatically disabled when the appliance is in Settings mode .

Switching Keypad Lock on or off /

Switch on Keypad Lock if you wish to protect your wine conditioning unit from unwanted temperature changes or other unintentional adjustments in settings mode .

- In settings mode , use the < and > arrow buttons to select Keypad Lock and touch *OK* to confirm your selection.
- Use the arrow buttons < and > to switch the keypad lock On or Off and confirm your selection with *OK*.
- The keypad lock will not be activated until you close the door of the wine conditioning unit.

Nothing will appear in the display to indicate that the keypad lock is switched on.



The message *Press OK for 6 seconds to unlock* will appear in the display if you select a sensor control while the keypad lock  is switched on.

- Follow the instructions on the display.

The display is unlocked briefly so you can adjust the settings as required. Closing the door of the wine conditioning unit will reactivate the keypad lock.

Performing a Self Test

Perform a Self Test if you are concerned that your wine conditioning unit is not working properly and want to check if it is suffering from any problems.

- In Settings mode , use the < and > sensor controls to select the Self Test and select *OK* to confirm your selection.
- Touch the sensor control  if you wish to terminate the process.

The Self Test starts and the wine conditioning unit is checked for any faults or malfunctions.

- The message *System restart* appears in the display if the Self Test does not discover any faults or malfunctions.
- If the Self Test does discover any faults or malfunctions, they are indicated as error messages in the display.

An alarm will also sound.

- If you find the alarm disruptive, you can switch it off in advance by touching the  sensor control.
- Make a note of the error message(s) displayed.
- Contact Miele Service and inform them of the error message(s) on the display.
- Confirm the message with *OK*.

System restart will appear on the display.

The wine conditioning unit briefly switches off and then back on automatically.

Self test completed will appear on the display.

- Confirm the message with *OK*.

The main screen appears in the display again.

Switching on the Door Assistant

You can choose between the two Door Assistants *Push2Open* and *Pull2Open*. The default Door Assistant is *Push2Open*.

The *Push2Open* Door Assistant is suitable for cabinet fronts without handles. The door will then open automatically when you gently press against it.

The *Pull2Open* Door Assistant is suitable for cabinet fronts with handles. The appliance door can be opened easily with little force.



 Risk of damage if the appliance door is closed prematurely.

When the Door Assistant is switched on, repeatedly closing the appliance door early can lead to damage or malfunctions.

Refrain from holding onto or closing the appliance door while automatic door opening is still extended. If you have indeed closed the appliance door, leave it closed for 5 minutes. Automatic door opening resets itself.



Selecting additional settings

Switching on Push2Open

- In Settings mode , use the < and > sensor controls to select Door Assistant and select *OK* to confirm your selection.
- Use the < and > sensor controls to select Mode and select *OK* to confirm your selection.
- Use the < and > sensor controls to select Push2Open and select *OK* to confirm your selection.
- Touch the  sensor control to return to the previous menu level.



– Adjusting the intensity

You can also adjust the intensity of the Push2Open function. The lower the set intensity, the less force required when you push against the appliance door.

- In Settings mode , use the < and > sensor controls to select Door Assistant and select *OK* to confirm your selection.
- In Settings mode , use the < and > sensor controls to select Intensity and select *OK* to confirm your selection.
- Use the < and > sensor controls to select the right intensity (Low, Medium, High) and select *OK* to confirm your selection.



– Adjusting the duration of the Auto-Close function

You can also adjust the duration for how long the appliance door will remain open until it closes automatically.

- In Settings mode , use the < and > sensor controls to select Door Assistant and select *OK* to confirm your selection.
- In Settings mode , use the < and > sensor controls to select AutoClose and select *OK* to confirm your selection.
- Use the + and – sensor controls to select the duration (5 to 30 seconds) and touch *OK* to confirm your selection.



To protect against inadvertent opening: if you do not pull the appliance door open, it will close again by itself after a duration defined by you.

Switching on Pull2Open



- In Settings mode , use the < and > sensor controls to select Door Assistant and select *OK* to confirm your selection.
- Use the < and > sensor controls to select Mode and select *OK* to confirm your selection.
- Use the < and > sensor controls to select Pull2Open and select *OK* to confirm your selection.
- Touch the  sensor control to return to the previous menu level.

– Adjusting the intensity

You can also adjust the intensity of the Pull2Open function. The lower the set intensity, the less force required when you pull the appliance door.

- In Settings mode , use the < and > sensor controls to select Door Assistant and select OK to confirm your selection.
- In Settings mode , use the < and > sensor controls to select Intensity and select OK to confirm your selection.
- Use the < and > sensor controls to select the right intensity (Low, Medium, High) and select OK to confirm your selection.

Switching off the Door Assistant

- In Settings mode , use the < and > sensor controls to select Door Assistant and select OK to confirm your selection.
- Use the < and > sensor controls to select Mode and select OK to confirm your selection.
- Use the < and > sensor controls to select Off and select OK to confirm your selection.
- Touch the  sensor control to return to the previous menu level.

Selecting additional settings

Miele@home

Setting up Miele@home

The message **Set up Miele@home** only appears if your wine storage unit has not yet been connected to a WiFi network.

- Connect your wine storage unit as described in “Before using for the first time”.

Deactivating Miele@home

- In Settings mode , use the < and > sensor controls to select the **Miele@home** and select **OK** to confirm your selection.
- Use the < and > sensor controls to select **Deactivate** and select **OK** to confirm your selection.

Deactivation successful will appear on the display.

- Confirm the message with **OK**.

Your wine conditioning unit is now disconnected from your WiFi network.

The  symbol will go out on the display.

Activating Miele@home

If you have already activated Miele@home and then disconnected the connection, you will need to reactivate the connection.

- In Settings mode , use the < and > sensor controls to select **Miele@home** and select **OK** to confirm your selection.
- Use the < and > sensor controls to select **Activate** and select **OK** to confirm your selection.

Activation successful will appear on the display.





- Confirm the message with **OK**.

If the WLAN connection is active,  will appear on the display.

Checking the WLAN connection status

- In Settings mode , use the < and > sensor controls to select **Miele@home** and select **OK** to confirm your selection.
- Use the < and > sensor controls to select **Connection status** and select **OK** to confirm your selection.

Information about the WLAN connection status will then appear on the display:

-  connected: there is a strong connection
-  connected: there is an average connection
-  connected: there is a weak connection
-  disconnected

Selecting additional settings

Setting up Miele@home again

If you have changed your WiFi network, you can set up Miele@home again for your wine conditioning unit.

- In settings mode , use the < and > arrow buttons to select Miele@home and select **OK** to confirm your selection.
- Use the < and > arrow buttons to select Set up again and touch **OK** to confirm your selection.

Reset configuration? appears on the display.

- Use the < and > arrow buttons to select Yes or No and touch **OK** to confirm your selection.

Resetting the network configuration

Reset the wine conditioning unit's settings to the default settings when disposing of your wine conditioning unit, selling it, or putting a used wine conditioning unit into operation. This will reset the network configuration so that all personal data is deleted from the wine conditioning unit. This will also ensure that a previous owner is no longer able to access the wine conditioning unit.

- Reset the settings of the wine conditioning unit as described in the chapter "Resetting the settings to their default settings ".

Switching off Demo Mode

Demo mode allows the wine conditioning unit to be presented in the showroom **without the cooling system being switched on**. Do not activate this setting for domestic use.

If Demo mode has been switched on as a default setting,  will show in the display.

- In settings mode , use the < and > arrow buttons to select Demo Mode and select **OK** to confirm your selection.

Press **OK** for 4 seconds to deactivate appears in the display.

- Follow the instructions on the display and touch and hold the sensor control **OK** for 4 seconds.

The countdown Demo Mode will deactivate in seconds. will appear in the display.

Demo Mode deactivated. The appliance will cool down. appears in the display.

- Confirm the message with **OK**.

The main screen appears in the display again.

Selecting additional settings

Resetting the settings to their default settings

You can reset the wine conditioning unit's settings to their default settings.

Reset the wine conditioning unit's settings to the default settings when disposing of your wine conditioning unit, selling it, or putting a used wine conditioning unit into operation. This will reset the network configuration so that all personal data is deleted from the wine conditioning unit. This will also ensure that a previous owner is no longer able to access the wine conditioning unit.

- In Settings mode , use the < and > sensor controls to select the *Factory Default* and select *OK* to confirm your selection.
- Use the < and > sensor controls to select *Reset* and select *OK* to confirm your selection.













After a brief delay, *Settings reset* appears in the display.

- Confirm the message with *OK*.

The initial commissioning process restarts (see “Before first use – Starting up for the first time”).

Selecting additional settings

The wine conditioning unit's settings will be reset to the following values:

| Function | Default settings |
|---|------------------------------------|
|  Language | English |
|  Display Brightness | Average value (4 of 7 segments) |
|  Color Scheme | Dark |
|  Buzzer Tones | Average value (4 of 7 segments) |
|  Keypad Tone | Average value (4 of 7 segments) |
| °F / °C Temperature Unit | °Fahrenheit |
|  Keypad Lock | Switched off |
|  Door Assistant | Push2open |
|  Miele@home | Switched off |
|  Ambient Lighting | Ambient 2 |
|  Ambient Display | Temperature display |
|  Sabbath Mode | Switched off |
|  Humidity | Not increased |
|  Temperature in the wine section | 52°F (11°C) |

Selecting additional settings

Switching Sabbath Mode on or off

The wine conditioning unit offers a Sabbath Mode for the purposes of religious observance.

When Sabbath Mode is switched on, you cannot make any settings on your wine conditioning unit.

Ensure that the appliance door is properly closed, as visual and audible alarms are switched off in Sabbath Mode.

- In Settings mode , use the < and > sensor controls to select the Sabbath Mode and select *OK* to confirm your selection.
- Use the < and > sensor controls to select On or Off and select *OK* to confirm your selection.

When Sabbath Mode is switched on,  will appear on the display and the display brightness will be reduced (the display does not change when the appliance door is closed).

When Sabbath Mode  is switched on, the following functions are switched off:

- Door Assistant
(for cabinet fronts without handles, the appliance door will have to be pulled from the bottom or side)
- Lighting
- All audible and visual signals,
- Temperature display
- The ambient lighting
(if previously switched on)

You can still select:

- the sensor control for Settings mode  so that Sabbath Mode can be switched off

The Sabbath Mode function will switch itself off automatically after approx. 125 hours.

Selecting additional settings

Switching Ambient Lighting on or off

The Ambient Lighting can be switched on so your wines are on display even when the appliance door is closed. The interior lighting now remains on even when the appliance door is closed.

Each wine conditioning zone has its own light so that your wine conditioning unit is lit up to maximum effect.

- Touch the  sensor control on the display so that it is highlighted in color.
- Close the appliance door.

The interior lighting now remains on even when the door is closed.

- To switch the Ambient Lighting off, touch the  sensor control so that it is no longer highlighted in color.

The interior lighting is now switched off when the appliance door is closed.

Selecting the intensity of the Ambient Lighting

You can set the intensity of the Ambient Lighting in Settings mode .

You can also choose the wine conditioning zones in which the Ambient Lighting should be switched on.

- In Settings mode , use the < and > sensor controls to select the Ambient Lighting and select *OK* to confirm your selection.
- Use the < and > sensor controls to select the correct setting (Ambience 1 – Ambience 5):
 - Ambience 1 – Ambience 3:
Weak to strong lighting in all wine conditioning zones
 - Ambience 4:
Only the lighting in the wine conditioning zone in the center is switched on
 - Ambience 5:
The lighting in the wine conditioning zone in the center is stronger than the lighting in the top and bottom wine conditioning zones.
- Confirm your selection with *OK*.
- Close the appliance door.

The Ambient Lighting is now set to the desired setting.

Thanks to the use of LED lighting, the wine will not be adversely affected by heat or UV light.

Selecting additional settings



Risk of injury from LED lighting. This lighting corresponds to risk group RG 2. If the cover is defective, there is a risk of eye injury.

If the lighting cover is defective, do not look from a close range directly into the lighting with optical instruments (e.g., magnifying glass or similar).

Selecting the Ambient Display

You can choose what the display should look like when the appliance door is closed.

- In Settings mode , use the < and > sensor controls to select the Ambient Display and select OK to confirm your selection.
- Use the < and > sensor controls to select the required display settings:
 - Temperature
 - Miele logo
 - Off (display switched off completely).
- Confirm your selection with OK.

The display settings you have selected are now active when the appliance door is closed.

As soon as you open the door, the main screen appears in the display in the usual way.

The ideal temperature and humidity

Wine continues to mature depending on the surrounding conditions. The length of time for which wine can be kept in good condition will therefore depend not only on the temperature but also on the air quality.

The wine conditioning unit with its constant ideal temperature, increased air humidity and odor-free atmosphere offers the perfect conditions for storing your wine.

The wine conditioning unit also guarantees a vibration-free environment (in contrast to a refrigerator) so that the maturing process is not disturbed.

Temperature

Wine can be stored at a temperature between 42° and 64°F (6° and 18°C). If you are storing white and red wines together, select a temperature between 53° and 57°F (12° and 14°C). This is suitable for both white and red wines. Red wine should be taken out of the wine conditioning unit and opened at least two hours before drinking to allow it to breathe and develop its aroma.

At too high a temperature (over 72°F / 22°C), wine matures too quickly, which prevents the aromas from developing further. Wine cannot mature fully at too low a temperature (below 41°F / 5°C).

Fluctuations in temperature put wine under stress and interrupt the maturing process. It is therefore very important to maintain a constant temperature.

| Type of wine | Recommended drinking temperature |
|-----------------------------------|----------------------------------|
| Light, fruity red wines: | 57° to 61°F (14° to 16°C) |
| Full-bodied red wines: | 64°F (18°C) |
| Rosé wines: | 46° to 50°F (8° to 10°C) |
| Delicate, aromatic white wines: | 46° to 54°F (8° to 12°C) |
| Full-bodied or sweet white wines: | 46° to +57°F (12° to 14°C) |
| Champagne, sparkling white wines: | 43° to 50°F (6° to 10°C) |

Tip: Store the wine 1° or 2° cooler than the recommended drinking temperature as it warms up a little when poured into the glass.

Tip: Full-bodied reds should be opened for 2-3 hours before drinking to allow it to breathe and develop its aroma.

Tip: We recommend removing the oxygen from opened bottles of wine to avoid loss of aroma and taste, as well as spoiling. Special devices (a wine pump with bottle stopper, for example) create a vacuum by extracting the air.

The ideal temperature and humidity

Isolator panels for thermal separation

The wine conditioning unit has two fixed isolator panels that divide the interior into three zones, which can be conditioned in different ways. This means that you can store up to three different types of wine at the same time – for example, red wine, white wine, and champagne.

Setting the temperature

- Touch the  sensor control to set the temperature.

The previously set temperatures for the 3 wine conditioning zones are displayed.

- Use the < and > sensor controls to select the wine conditioning zone for which you want to adjust the temperature and select *OK* to confirm your selection.
- Use the + and – sensor controls to set the temperature. Keeping your finger on the sensor control changes the temperature continuously.
- Confirm the temperature setting with *OK* or wait approx. 8 seconds after the last touch of the sensor. This temperature will be automatically adopted.

Tip: The new temperature setting can also be confirmed and adopted by closing the appliance door.

The ideal temperature and humidity

The temperature display always shows the **required** temperature.

If you have adjusted the temperature, **wait for approx. 6 hours if the wine conditioning unit is not very full and for approx. 24 hours if the wine conditioning unit is full** before checking the temperature display. It will take this long for an accurate reading to be given.

- If, after this time, the temperature is still too high or too low, adjust it again.

Temperature range

In all three zones, it is possible to set temperatures between 41°F and 68°F (5°C and 20°C).

Humidity

In most refrigerators the humidity is too low for wine and therefore a refrigerator is not suitable for wine conditioning. Higher humidity levels are necessary when storing wine to moisturize natural corks from the outside. When the humidity is too low the natural corks dry out and the bottle is no longer tightly sealed. For this reason wine bottles should always be stored horizontally to ensure that natural corks are also moisturized from the inside. If air gets into the bottle, this will have a negative impact on the wine!

Tip: Humidity levels can be set separately for each wine conditioning zone. Always increase the humidity level in a wine conditioning zone whenever you are using it to store wine bottles sealed with natural corks.

 Risk of damage caused by excess moisture

This will lead to condensation on the interior walls, which can cause corrosion damage.

Do **not** introduce additional moisture into the air, e.g., by placing a dish of water inside the wine conditioning unit.

Increasing the humidity δ

If you have set a higher level of humidity, the fans will switch on automatically. This will distribute the humidity and the temperature evenly around the wine conditioning unit so that you can store all your wine under the same excellent conditions. The fans switch off automatically when the appliance door is opened and remain switched off for as long as it is kept open.

- Touch the  sensor control to set the temperature.
- Use the < and > sensor controls to select the wine conditioning zone for which you want to increase the humidity and select *OK* to confirm your selection.
- Touch the δ button.

The δ button will then be highlighted in color.

- Confirm your selection with *OK* or wait approx. 8 seconds after touching the button for the last time. The setting will be automatically adopted.

The humidity increases in the selected wine conditioning zone.

The ideal temperature and humidity

Not increasing the humidity δ

- Touch the  sensor control to set the temperature.
- Use the < and > sensor controls to select the wine conditioning zone for which you do not want to increase the humidity and select *OK* to confirm your selection.
- Touch the δ button.

The δ button will then no longer be highlighted in color.

- Confirm your selection with *OK* or wait approx. 8 seconds after touching the button for the last time. The setting will be automatically adopted.

The humidity decreases in the selected wine conditioning zone.

Door alarm

An alarm will sound if the appliance door has been left open for longer than approx. 2 minutes.

The *Close the door* message also appears on the display.

As soon as the door is closed, the alarm will stop and the message on the display will disappear.

Turning the door alarm off early

If the alarm disturbs you, it can be turned off early.

- Touch the *OK* sensor control in the display.

The alarm stops and the message disappears from the display.

After a certain time the alarm will sound again and the message will reappear in the display until the appliance door is closed.

Storing wine bottles

Always observe USDA food safety guidelines.

 **WARNING! Fire hazard!**

Do not operate any electrical equipment inside the wine conditioning. This can cause sparking.

Vibration and movement have a negative effect on the maturing process which can in turn affect the taste of the wine.

To avoid disturbing other bottles when removing a bottle of wine, store bottles of the same type beside each other on the same shelf. Avoid stacking bottles on top of one another on the wooden shelves.

Always place the bottles in a horizontal position so that the natural corks can be kept moist on the inside and air is prevented from getting into the bottles.

Tip: We also recommend increasing the humidity level inside the wine conditioning unit for wine bottles with natural corks (see “Increasing the humidity Δ ” under “Optimum temperature and air quality”).

 Risk of injury from falling wine bottles.

Wine bottles may become wedged in the wooden shelves above and fall out of the wine conditioning unit when the shelves are pulled out. Always pull out the wooden shelves slowly and carefully.

 Risk of damage and injury from broken glass.

If wooden shelves and bottles protrude too far forwards, they will damage the glass door when it is closed. Please ensure that the wooden shelves and wine bottles do not protrude.

Do not cover the vents in the rear wall, as they are essential for keeping the appliance cool.

Wooden shelves

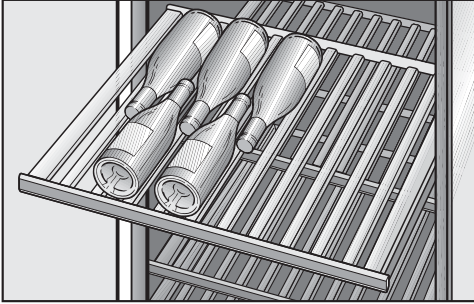

The wooden shelves are mounted on telescopic runners which can be pulled out to make it easier to store and remove bottles.

Moving the wooden shelves

The wooden shelves can be removed and replaced again if required.

- Pull the wooden shelf out until it stops, then lift it up and off the runners. Hold onto the frame to do this.
- To replace the shelf, click it into place on the extended rails from above. The strip must face the front.

Adjusting the wooden shelves

The slats in the wooden shelves can be individually adjusted to suit, so that every bottle is stored in perfect safety regardless of shape or size.

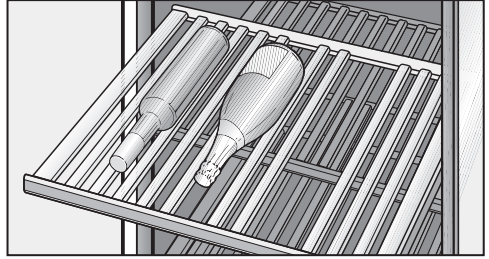

- Simply lift individual slats to move or remove them from the wooden shelves. This makes it easy to adjust the wooden shelf for any size of your wine bottle.

Storing wine bottles

Labeling the wooden shelves

For quick and easy identification of the wines stored, you can write on the blackboard-painted surface of the strips on the wooden shelves.

You can write directly on the strip or remove it from the wooden shelf. To do so:

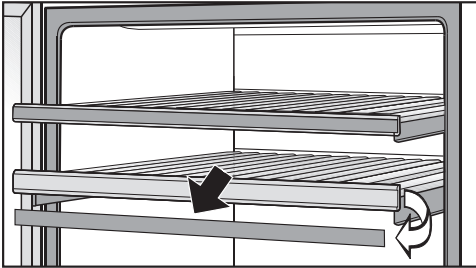

- Hold the strip by the sides and pull it forwards.
- The strip can be wiped clean with a damp cloth.

 Risk of damage due to incorrect cleaning.

The blackboard coating on the labeling strips may be damaged.

Use clean water only to wipe the strip. **Do not use a cleaning agent.**

- Label the strip with the chalk supplied and replace it on the wooden shelf from above.

Maximum capacity

 Risk of damage due to heavy loads.

Excessive loads can damage the wooden shelves.

Do not exceed the maximum load-bearing capacity of 77 lb (35 kg) for each wooden shelf.

Do not stack bottles on the wooden shelves.

Up to 91 Bordeaux bottles (0.75 l (25.4 fl oz.)) can be stored in the wine conditioning unit.

Setting up the SommelierSet

The SommelierSet can be used to have your wine ready for drinking, straight from the wine conditioning unit. You can store wine glasses and accessories, decant your wine, and store open bottles in the wine conditioning unit.

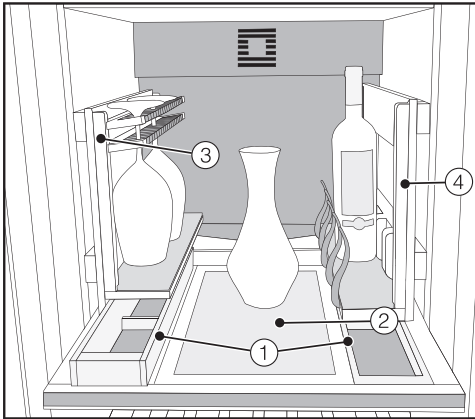

- ① Large and small box for accessories
- ② Decanter plate, e.g., for wine carafes
- ③ Glass holder to store and cool wine glasses
- ④ Bottle holder with adjustable retainers for wine bottles of varying sizes

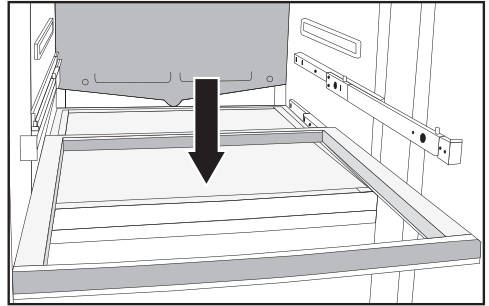

For ideal access, the SommelierSet sits on the wooden shelf at the bottom of the wine conditioning zone in the center of the wine conditioning unit.

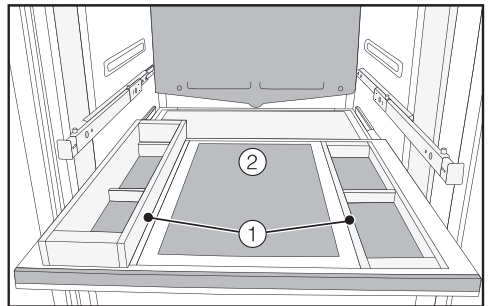

- Place the large accessory box on the left and the small accessory box ① on the right on the wooden shelf.
- Place the decanter plate ② in the centre of the wooden shelf.

SommelierSet

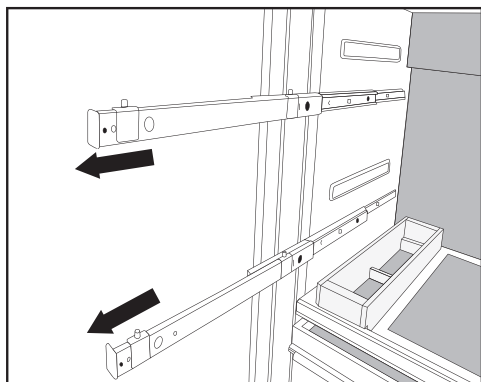

- Pull the runners above the bottom shelf out as far as they will go on both sides.

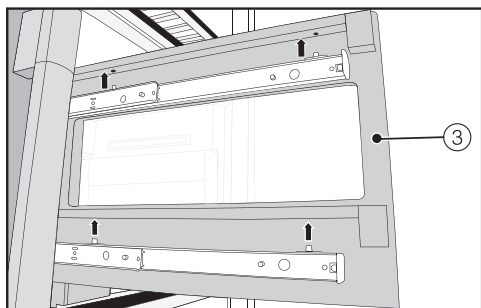

- Position the glass holder ③ on the runner on the left and the bottle holder ④ on the runner on the right. Check that the pins on the runners engage in the mounts on the both the glass holder and the bottle holder.

- Push the glass holder ③ and the bottle holder ④ all the way into the unit.

- Next, place the felt inside the accessory boxes ① and on top of the decanter plate ②, the glass holder ③, and the bottle holder ④.

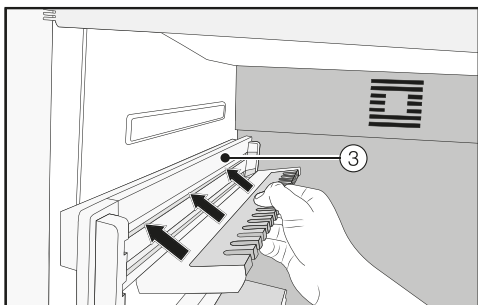

- Insert the two racks into the glass holder ③.

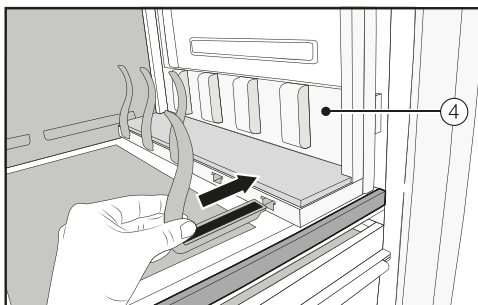

- Slide the retainers into the bottle holder ④.

Tip: The retainers can be adjusted individually to suit the size of your wine bottles.

 **WARNING! DANGER** of injury and damage!

Do not use any mechanical or other types of aids which are not recommended by the manufacturer to accelerate the defrosting process.

The wine conditioning unit defrosts automatically.

Cleaning and care

 **WARNING! DANGER** of electric shock!
Unplug the appliance or trip the circuit breaker.

 **WARNING! Fire hazard!**
Do not damage the coolant pipework.

Do not let water get into the electronic unit or the lighting.

Do not use a steam cleaning appliance to clean this wine conditioning unit. The steam could reach electrical components and cause a short circuit.

Do not remove the data plate located inside the wine conditioning. It contains information which is required in the event of a service call.

Cleaning agents

To avoid damaging the surfaces of your appliance, **do not** use:

- cleaning agents containing soda, ammonia, acids, or chloride
- cleaning agents containing lime scale remover
- abrasive cleaning agents, such as scouring powder, scouring liquid, or pumice stones
- cleaning agents containing solvents
- stainless-steel cleaning agents
- dishwasher cleaner
- oven sprays
- glass cleaner (except on the glass in the appliance door)
- hard, abrasive sponges and brushes, such as pot scrubbers
- eraser sponges
- sharp metal scrapers

Cleaning and conditioning agents used inside the wine conditioning unit must be food safe.

We recommend using lukewarm water and a little liquid dish soap for cleaning.

Before cleaning the wine conditioning unit

- Switch the wine conditioning unit off by pressing the On/Off switch.
- Take any wine bottles out of the wine conditioning unit and store them in a cool place.
- Take out all other removable parts for cleaning (see “Storing wine bottles – Moving the wooden shelves”).
- Remove the labeling strips from the wooden shelves before cleaning them (see “Storing wine bottles – Labeling wooden shelves”).

Interior, accessories, and appliance door

Clean the wine conditioning unit regularly, or at least once a month. Clean up any spills, stains, or food immediately. Do not allow them to dry and stick to the appliance.

- Clean the interior cabinet of the wine conditioning unit with a solution of lukewarm water and a little liquid dish soap. Rinse all parts by hand. Do not wash in a dishwasher.
- After cleaning, wipe with clean water and dry with a soft cloth.



⚠ Risk of damage due to incorrect cleaning.

The blackboard coating on the labeling strips may be damaged.

Use clean water only to wipe the labeling strips on the wooden shelves. Do **not** use a cleaning agent.

- The wooden shelves should only be wiped with a well wrung-out damp cloth. They must **not** be allowed to get wet.
- Leave the wine conditioning unit open to air it sufficiently for a short while and to prevent odor build-up.
- Clean the glass panes in the appliance door with a proprietary glass cleaner.

Cleaning and care

Appliance front

The appliance front has a special high-quality finish (Clean Touch Steel). This is resistant to soiling and is very easy to clean.

 **Do not use stainless steel cleaning agent** on these surfaces, as it will damage the finish.

Do not use Miele stainless steel conditioning agent on these surfaces, as it will cause noticeable smearing.

If soiling is allowed to sit for any length of time, it may become impossible to remove.

Surfaces may become discolored or damaged.

It is therefore best to remove soiling from the appliance front immediately.

All surfaces are easily scratched. Contact with unsuitable cleaning agents can alter or discolor the surfaces.

See the information on “Cleaning agents” at the beginning of this section.

- Clean the surfaces with a clean sponge and a solution of warm water and liquid dish soap. A clean, damp microfiber cloth without cleaning agent can also be used for cleaning.
- After cleaning, wipe with clean water and dry with a soft cloth.

Cleaning the door seal

 Risk of damage as a result of incorrect cleaning.

If you treat the door seal with oil or grease, it can become porous.

Do not use oil or grease on the door seal.

- The door seals should be cleaned regularly with clean water, and then wiped dry with a soft cloth.

Cleaning the ventilation gaps

A build-up of dust will increase the energy consumption of the appliance.

- The ventilation gaps should be cleaned on a regular basis with a brush or vacuum cleaner (you could use a Miele Vacuum Cleaner dust brush, for example).

After cleaning

- Replace all parts in the wine conditioning unit.
- Reconnect to the electricity supply and switch the wine conditioning unit back on.
- Place the wine bottles back in the wine conditioning unit and close the appliance door.

Frequently Asked Questions

With the help of the following guide minor faults in the performance of the machine, some of which may result from incorrect operation, can be remedied without contacting the Service Department.

This guide may help you to find the reason for the fault, and how to correct it.







To prevent cold from escaping, open the appliance doors as little as possible until the fault has been corrected.

| Problem | Possible cause and solution |
|---|--|
| <p>If you are concerned that your appliance is not working properly, you can perform a Self Test. Your appliance will be checked for any faults or malfunctions.</p> | <p>Any errors identified during the Self Test are shown on the display.</p> <ul style="list-style-type: none"> ■ Perform a Self Test (see “Additional settings”, section “Performing a Self Test <input checked="" type="checkbox"/>”). ■ Contact Miele Service and inform them of the error message(s) on the display. |
| <p>The wine conditioning unit is not getting cold and the interior lighting does not come on when the appliance door is opened.</p> | <p>The wine conditioning unit is not switched on.</p> <ul style="list-style-type: none"> ■ Switch the wine conditioning unit on. The temperature appears in the display. <p>The plug is not properly plugged into the electrical outlet.</p> <ul style="list-style-type: none"> ■ Insert the plug into the outlet. <p>The fuse has tripped. There could be a fault with the wine conditioning unit, the household electrical wiring, or another appliance.</p> <ul style="list-style-type: none"> ■ Contact a technician or the Miele Service department. |
| <p>The compressor is turning on more frequently and for longer periods of time; the temperature inside the wine conditioning unit is too low.</p> | <p>The temperature in the wine conditioning unit is set too low.</p> <ul style="list-style-type: none"> ■ Correct the temperature setting. <p>The ventilation gaps in the cabinetry have been covered or become too dusty.</p> <ul style="list-style-type: none"> ■ Do not block the ventilation gaps. ■ Clean the ventilation gaps on a regular basis to remove any dust. <p>The appliance door has been opened too frequently, or a large number of wine bottles have been put inside the unit all at once.</p> |

Frequently Asked Questions











| Problem | Possible cause and solution |
|---|--|
| | <ul style="list-style-type: none"> ■ Only open the appliance door when necessary and for as short a time as possible. After a while, the temperature will return to normal by itself. <hr/> <p>The appliance door is not properly closed.</p> <ul style="list-style-type: none"> ■ Close the appliance door. After a while, the temperature will return to normal by itself. <hr/> <p>The ambient temperature is too high. The higher the ambient temperature, the longer the compressor has to run.</p> <ul style="list-style-type: none"> ■ See the information in the section on “Installation – Installation location”. <hr/> <p>The wine conditioning unit has not been installed properly in the installation niche.</p> <ul style="list-style-type: none"> ■ See the information in “Installation – Installing the wine conditioning unit”. |
| <p>The compressor comes on less and less often and for shorter periods of time. The temperature inside the wine conditioning unit rises.</p> | <p>This is not a fault. The temperature setting is too high.</p> <ul style="list-style-type: none"> ■ Correct the temperature setting. ■ Check the temperature again after 24 hours. |
| <p>The compressor runs continuously.</p> | <p>Not a fault. To save energy, the compressor runs at a lower speed when less cooling is required. This increases the compressor run time.</p> |
| <p>An alarm sounds.</p> | <p>The door of the wine conditioning unit has been open for longer than approx. 2 minutes.</p> <ul style="list-style-type: none"> ■ Close the door. |

Frequently Asked Questions

| Problem | Possible cause and solution |
|---|--|
| <p>No alarm sounds despite the appliance door being open.</p> | <p>You have switched off the audible signal.</p> <ul style="list-style-type: none"> ■ Switch the audible signal back on using Settings mode . <p>The Sabbath Mode  function is switched on: the temperature display is dark and the  symbol is shown on the display.</p> <ul style="list-style-type: none"> ■ You can switch off Sabbath mode at any time (see “Selecting additional settings – Switching Sabbath Mode  on or off”). |
| <p>The door of the wine conditioning unit cannot be opened.</p> | <p>The Pull2Open Door Assistant is switched on but the wine conditioning unit has a handle-free cabinet front.</p> <ul style="list-style-type: none"> ■ For handle-free cabinet fronts, switch on the Push2Open Door Assistant (see “Selecting additional settings – Switching on the Door Assistant ”). |
| <p>The appliance door cannot be opened when Sabbath Mode  is switched on.</p> | <p>The Push2Open Door Assistant is switched on at the same time as Sabbath Mode.</p> <ul style="list-style-type: none"> ■ When Sabbath Mode is switched on, the Door Assistant is deactivated. ■ Pull the door open from below or from the side. |







Frequently Asked Questions

Messages in the display

| Message | Possible cause and solution |
|---|---|
| <p>The warning sounds and the message  appears on the display.</p> | <p>The appliance door is open.</p> <ul style="list-style-type: none"> ■ Close the appliance door. ■ If you wish to turn the alarm off early, touch the sensor control <i>OK</i> on the display. <p>The alarm will stop.</p> |
| <p>The temperature display is dark and the  symbol is shown on the display.</p> | <p>The Sabbath Mode  function is switched on. The interior lighting is switched off and the wine conditioning unit is cooling down.</p> <ul style="list-style-type: none"> ■ You can switch off Sabbath mode at any time (see “Selecting additional settings – Switching Sabbath Mode  on or off”). |
| <p>“F Please contact Miele Technical Service.”  appears in the display and an alarm sounds.</p> | <p>There is a fault.</p> <ul style="list-style-type: none"> ■ Make a note of the fault message if necessary. ■ Contact Miele Service. ■ To turn the alarm off, touch the  symbol. <p>The error message does not disappear from the display until the error has been rectified.</p> |
| | <p>The voltage level is too high/low.</p> <ul style="list-style-type: none"> ■ Observe the connection data under “Electrical connections”. ■ Contact Miele Service if necessary. ■ To turn the alarm off, touch the  symbol. <p>The error message does not disappear from the display until the error has been rectified.</p> |
| <p> is shown in the display. The machine does not get cold, but the machine controls are working.</p> | <p>Demo Mode  is switched on. Demo mode allows the appliance to be presented in the showroom without the cooling system being turned on. Do not activate this setting for domestic use.</p> <ul style="list-style-type: none"> ■ Switch off Demo mode  (see “Selecting additional settings”, section “Switching off Demo Mode ”). |

Frequently Asked Questions

The interior lighting is not working.

| Problem | Possible cause and solution |
|---|---|
| <p>The interior lighting is not working.</p> | <p>The wine conditioning unit is not switched on.</p> <ul style="list-style-type: none"> ■ Switch the wine conditioning unit on. |
| | <p>The Sabbath Mode function is switched on: the temperature display is dark and the  symbol is shown on the display.</p> <ul style="list-style-type: none"> ■ You can switch off Sabbath Mode at any time via the Settings mode . |
| | <p>There is a fault.</p> <div style="border: 1px solid gray; padding: 5px; margin-bottom: 10px;"> <p> Risk of electric shock due to exposed, live electrical components.</p> <p>When removing the lighting cover, there is a risk of coming into contact with live electrical components.</p> <p>Do not remove the lighting cover. The LED lighting may only be repaired or replaced by Miele Service.</p> </div> <div style="border: 1px solid gray; padding: 5px;"> <p> Risk of injury from LED lighting.</p> <p>This lighting corresponds to risk group RG 2. If the cover is defective, there is a risk of eye injury.</p> <p>If the lighting cover is defective, do not look from a close range directly into the lighting with optical instruments (e.g., magnifying glass or similar).</p> </div> <ul style="list-style-type: none"> ■ Contact Miele Service. |
| <p>The interior lighting is on even when the appliance door is closed.</p> | <p>The Ambient Lighting function is switched on.</p> <ul style="list-style-type: none"> ■ Switch off the Ambient Lighting  function (see “Selecting additional settings – Switching Ambient Lighting  on or off”). |

Frequently Asked Questions

General problems with the wine conditioning unit

| Problem | Possible cause and solution |
|--|---|
| Bacteria has begun to form on the wine bottle labels. | Bacteria may form on the labels, depending on the type of label adhesive used. ■ Clean the wine bottles and remove any adhesive residue. |
| The slats on the wooden shelves are warping. | Volume change due to moisture absorption or drying out is a typical characteristic of wood. An increase in humidity will cause wooden components to warp, which can lead to cracking. Knots and wavy grain are characteristic for wood and cannot be avoided. |
| A white deposit has formed on the wine bottle corks. | The corks have oxidized due to contact with the air. ■ Use a dry cloth to wipe off the deposit. The deposit will not affect the quality of the wine. |

Causes of noises

| Normal noises | Cause |
|---|--|
| Brrrrr ... | A humming noise is made by the motor (compressor). This noise can get louder for brief periods when the motor switches on. |
| Blub, blub ... | A gurgling noise can be heard when the refrigerant circulates through the pipes. |
| Click ... | Clicking sounds occur whenever the thermostat switches the motor on or off. |
| Crack ... | A cracking sound can be heard when material inside the wine conditioning unit expands. |
| Please bear in mind that a certain amount of noise is unavoidable (from the compressor and the refrigerant circulating through the system). | |

| Noises | Cause and solution |
|---------------------------|--|
| Rattling, clinking | The wine storage unit is uneven. Realign it using a level by raising or lowering the adjustable feet underneath the wine storage unit. |
| | The wine storage unit is touching other appliances or pieces of cabinetry. Move it away. |
| | Shelves are unstable or sticking. Check all removable parts and reinsert them correctly if required. |
| | Bottles or containers are touching each other. Separate them. |

Customer Service

Contact in the event of a fault

In the event of a fault which you cannot remedy yourself, please contact your Miele dealer or Miele Customer Service.

You can book a Miele Service Call online at www.miele.com/service.

Contact information for Miele Customer Service can be found at the end of this document.

Please quote the model identifier and serial number of your appliance (SN) when contacting Miele Customer Service. Both pieces of information can be found on the data plate.

You will find the data plate inside your appliance.

Appliance warranty and product registration

You can register your product and/or view the manufacturer's warranty terms and conditions for Miele appliances and vacuum cleaners at www.mieleusa.com.

Declaration of conformity

| | |
|-----------------|--------------------------|
| Frequency range | 2.412 GHz – 2.462 GHz |
|-----------------|--------------------------|

| | |
|----------------------------|----------|
| Maximum transmitting power | < 100 mW |
|----------------------------|----------|

Copyrights and licenses

Miele uses their own and third party software which is not subject to any so-called open source license for the operation and control of the device/appliance. This software/these software components are protected by copyright. The copyright powers of Miele and third parties have to be respected.

Furthermore, this device/appliance contains software components which are distributed under open source license conditions. Please refer to the document “Open Source Information and Licenses” for the Open Source components contained therein, together with the corresponding copyright notices, copies of the licensing conditions valid at the time, and any further information. The liability and warranty provisions of the open source licensing conditions as stated therein apply only in relation to the respective rights holders.

In particular, the device/appliance contains software components licensed by the copyright holders under the GNU General Public License, Version 2, or the GNU Lesser General Public License, Version 2.1. For a period of at least 3 years from the date of purchase or delivery of the device/appliance respectively, Miele offers to provide you or third parties with a machine-readable copy of the source code of the Open Source components contained in the device/appliance and licensed under the terms of the GNU General Public License, Version 2, or the GNU Lesser General Public License, Version 2.1, on a data carrier (CD-ROM, DVD or USB stick). Please contact us via e-mail (info@miele.com) or the below postal address and state the product name, the serial number and the date of purchase to obtain this source code.

Miele & Cie. KG
Open Source
GTZ/TIM
Carl-Miele-Straße 29
33332 Gütersloh

Please note the limited warranty in favor of the rights holders under the terms of the GNU General Public License, Version 2, and the GNU Lesser General Public License, Version 2.1:

This program is distributed in the hope that it will be useful, but WITHOUT ANY WARRANTY, without even the implied warranty of MERCHANTABILITY of FITNESS FOR A PARTICULAR PURPOSE. See the GNU General Public License and GNU Lesser General Public License for more details.

**Please have the model and serial number
of your appliance available when
contacting Customer Service.**

U.S.A.

Miele, Inc.

National Headquarters

9 Independence Way
Princeton, NJ 08540

Customer Service & Support

Phone: 888-99-MIELE(64353)
info@mieleusa.com
www.mieleusa.com

International Headquarters

Miele & Cie. KG
Carl-Miele-Straße 29
33332 Gütersloh
Germany

Canada

**Importer
Miele Limited**

Headquarters and Miele Centre

161 Four Valley Drive
Vaughan, ON L4K 4V8
www.miele.ca

Customer Care Centre

Phone: 800-565-6435
905-532-2272
customercare@miele.ca

KWT 2662 SFS

en-US, CA

M.-Nr. 11 508 740 / 02