

# SAMSUNG

## Product Guide

# 7074 Series Convertible Upright Freezer

**RZ11M7074SA**

Available in Stainless Look



# Table of Contents

## RZ11M7074SA – 11.4 cu. ft. Capacity Convertible Upright Freezer

### Product Overview

Product Overview 4

Carousel Image Order 5

### Product Messaging

Features and Benefits 7

### Product Specs

Review Mapping 11

Spec Sheet 12

Energy Guide and Manual 13

### Feature Icons

15

# Product Overview

---

**RZ11M7074SA – 11.4 cu. ft. Capacity Convertible Upright Freezer**

# Product Overview

## Product Title

11.4 cu. ft. Capacity Convertible Upright Freezer

## Short Product Description

Samsung's efficiently designed Convertible Upright Freezer provides 11.4 cu. ft. of storage, with a reversible door.

## Long Product Description

The 11.4 cu. ft. Samsung Convertible Upright Freezer features a convertible zone that can switch from freezer to fridge. It's designed for flexibility with removable drawers, adjustable door bins and shelves. High-efficiency LED lighting makes it easy to find exactly what you are looking for.

## Available Color



## Stainless Look

RZ11M7074SA



# Carousel Image Order

## Easy Ad links



R.COM - <http://www.samsungeasyads.com/mm/nicePath/easyads?nav=pr659467014>  
S.COM - <http://www.samsungeasyads.com/mm/nicePath/easyads?nav=pr659467047>





# Product Messaging

---

**RZ11M7074SA – 11.4 cu. ft. Capacity Convertible Upright Freezer**

Features and Benefits – RZ11M7074SA				
Overall Product Headline	Feature Name	Long Body Copy	Short Body Copy	Associated Image
Switch from freezer to fridge	Convertible Zone	A convertible freezer, which can switch between freezer and fridge, is perfect for any home, no matter what your needs.	Convertible from freezer to fridge.	
Designed for ultimate storage	Organizational Options	All drawers can be removed for more shelf space, door bins can be raised and lowered, and shelves can be adjusted. Design it for what you need to store.	Flexibility to store and find everything in a snap.	
ENERGY STAR® Certified	ENERGY STAR® Certified	Eco-friendly and energy-efficient.* <small>*Visit <a href="http://www.energystar.gov">www.energystar.gov</a> for more information on ENERGY STAR guidelines.</small>	Eco-friendly and energy-efficient.* <small>*Visit <a href="http://www.energystar.gov">www.energystar.gov</a> for more information on ENERGY STAR guidelines.</small>	

**Features and Benefits – RZ11M7074SA (Continued)**

Overall Product Headline	Feature Name	Long Body Copy	Short Body Copy	Associated Image
<p><b>A most flexible door</b></p>	<p><b>Reversible Door</b></p>	<p>The reversible door makes it adjustable to any space, in any direction.</p>	<p>Adjust the door to fit in any space.</p>	
<p><b>Even cooling, top to bottom</b></p>	<p><b>All-Around Cooling</b></p>	<p>Multi-vent technology keeps items evenly cooled on every shelf.</p>	<p>Keep every item evenly cooled.</p>	
<p><b>Freezes super fast</b></p>	<p><b>Power Freeze</b></p>	<p>Speeds up the freezing process at maximum fan speed and can maintain full speed for 50 hours.</p>	<p>Speeds up the freezing process.</p>	<p>N/A</p>



## Features and Benefits – RZ11M7074SA (Continued)

Overall Product Headline	Feature Name	Long Body Copy	Short Body Copy	Associated Image
<p><b>High-Efficiency LED Lighting</b></p>	<p><b>High-Efficiency LED Lighting</b></p>	<p>LED lighting designed to beautifully light up the interior of your freezer.</p>	<p>Lights up your entire freezer.</p>	

# Product Specs

---

**RZ11M7074SA – 11.4 cu. ft. Capacity Convertible Upright Freezer**

# Review Mapping

Model #	Type	Color
RZ11M7074SA	Convertible Upright Freezer	Stainless Look

# Spec Sheet

## Easy Ads link

<http://www.samsungeasyads.com/mm/nicePath/easyads?nav=pr659399338>

## RZ11M7074SA

11.4 cu. ft. Convertible Upright Freezer



### Signature Features

**Convertible Zone**

- A convertible freezer, that can switch between fridge or freezer, is perfect for any home, no matter what their needs.

**Organizational Options**

- All drawers can be removed for more shelf space, door bins can be raised and lowered, and shelves can be adjusted. Design it to what you need to store.

**ENERGY STAR® Certified**

- Eco-friendly and energy-efficient.\*
- \*Visit [www.energystar.gov](http://www.energystar.gov) for more information on ENERGY STAR guidelines.



Convertible Zone



Organizational Options

**Available Color**

Stainless Look

**Design**

- Convertible Zone
- Organizational Options
- Reversible Door
- 11.4 cu. ft. Capacity
- High-Efficiency LED Lighting
- Digital Display Buttons

**Convenience**

- Dongle Ready
- 3 Spill-Proof Shelves
- 4 Crisper Drawers
- 3 Door Bins
- Child Lock
- Door Alarm
- Adjustable Freezer Mode: Temperatures between 5°F and -8°F (0°F default temperature)
- Adjustable Fridge Mode: Temperatures between 44°F and 34°F (37°F default temperature)
- Mode Select - Switch between Freezer and Fridge Modes

**Performance**

- All-Around Cooling
- Surround AirFlow
- Power Freeze
- Cool Tight Door

**Rating**



ENERGY STAR® Rated:  
361 kWh/yr



Spec Sheet - front

## RZ11M7074SA

11.4 cu. ft. Convertible Upright Freezer

**Installation Requirements**

- Solid, level surface without carpeting or flooring that may obstruct ventilation
- Away from direct sunlight
- Adequate room for opening and closing the door
- Away from a heat source
- Room for maintenance and servicing
- Temperature range: between 50°F (10°C) and 110°F (43°C)

**Dimensions**

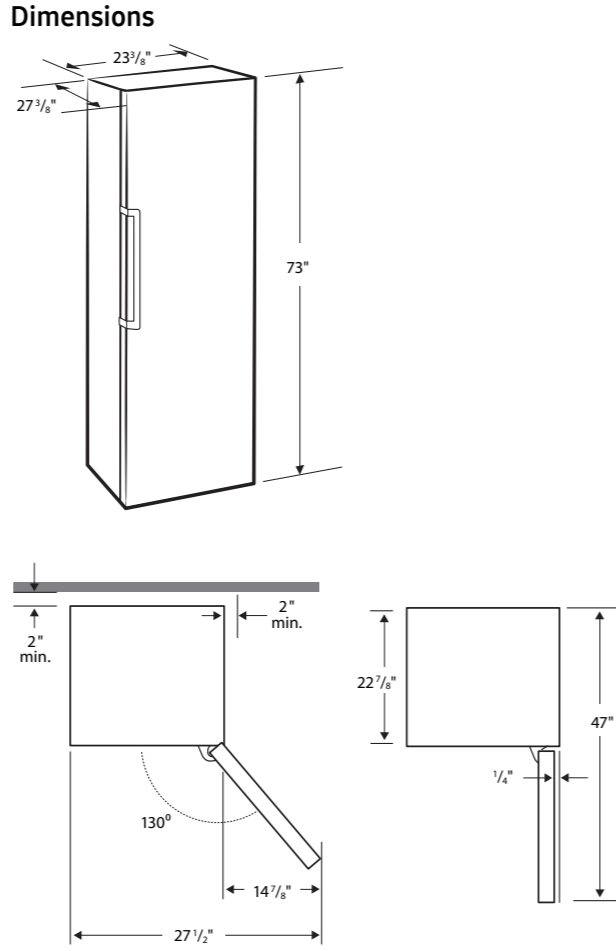

**Freezer Capacity: 11.4 cu. ft.**

- 3 Spill-Proof Shelves
- 4 Crisper Drawers
- 3 Door Bins
- High-Efficiency LED Lighting
- Adjustable Freezer Mode: Temperatures between 5°F and -8°F (0°F default temperature)
- Adjustable Fridge Mode: Temperatures between 44°F and 34°F (37°F default temperature)
- Mode Select - Switch between Freezer and Fridge Modes

**Warranty**

One (1) Year Parts and Labor  
Five (5) Years Parts and Labor on Sealed Refrigeration System Only\*  
Ten (10) Years Parts and Five (5) Years Labor on Digital Inverter Compressor Only

\*Compressor, evaporator, condenser, drier and connecting tubing.

**Product Dimensions & Weight**

Dimensions (WxHxD with hinges, handle and door):  
23 3/8" x 73" x 27 1/8"

Dimensions (WxHxD without hinges and door):  
23 3/8" x 73" x 22 7/8"

Weight: 168 lbs

**Shipping Dimensions & Weight (WxHxD)**

Dimensions: 25 1/2" x 76 1/8" x 30"

Weight: 179 lbs

<b>Color</b>	<b>Model #</b>	<b>UPC Code</b>
Stainless Look	RZ11M7074SA	887276440378



Spec Sheet - back

Freezer: Overview | Messaging | Specs | Icons

Samsung proprietary and confidential

# Energy Guide and Manual

Easy Ads link

<http://www.samsungeasyads.com/mm/nicePath/easyads?nav=pr659399338>

U.S. Government Federal law prohibits removal of this label before consumer purchase.

# ENERGYGUIDE

Upright Freezer  
• Automatic Defrost

Samsung  
Model RZ11M7074\*\*  
Capacity: 11.4 Cubic Feet

**Compare ONLY to other labels with yellow numbers.**  
Labels with yellow numbers are based on the same test procedures.

**Estimated Yearly Energy Cost**

## \$43

\$59 Cost range of similar models \$59

The estimated yearly energy cost of this model was not available at the time the range was published.

**361 kWh**  
Estimated Yearly Electricity Use

- Your cost will depend on your utility rates and use.
- Cost range based only on upright freezer models of similar capacity with automatic defrost.
- Estimated energy cost based on a national average electricity cost of 12 cents per kWh.

ftc.gov/energy



Energy Guide

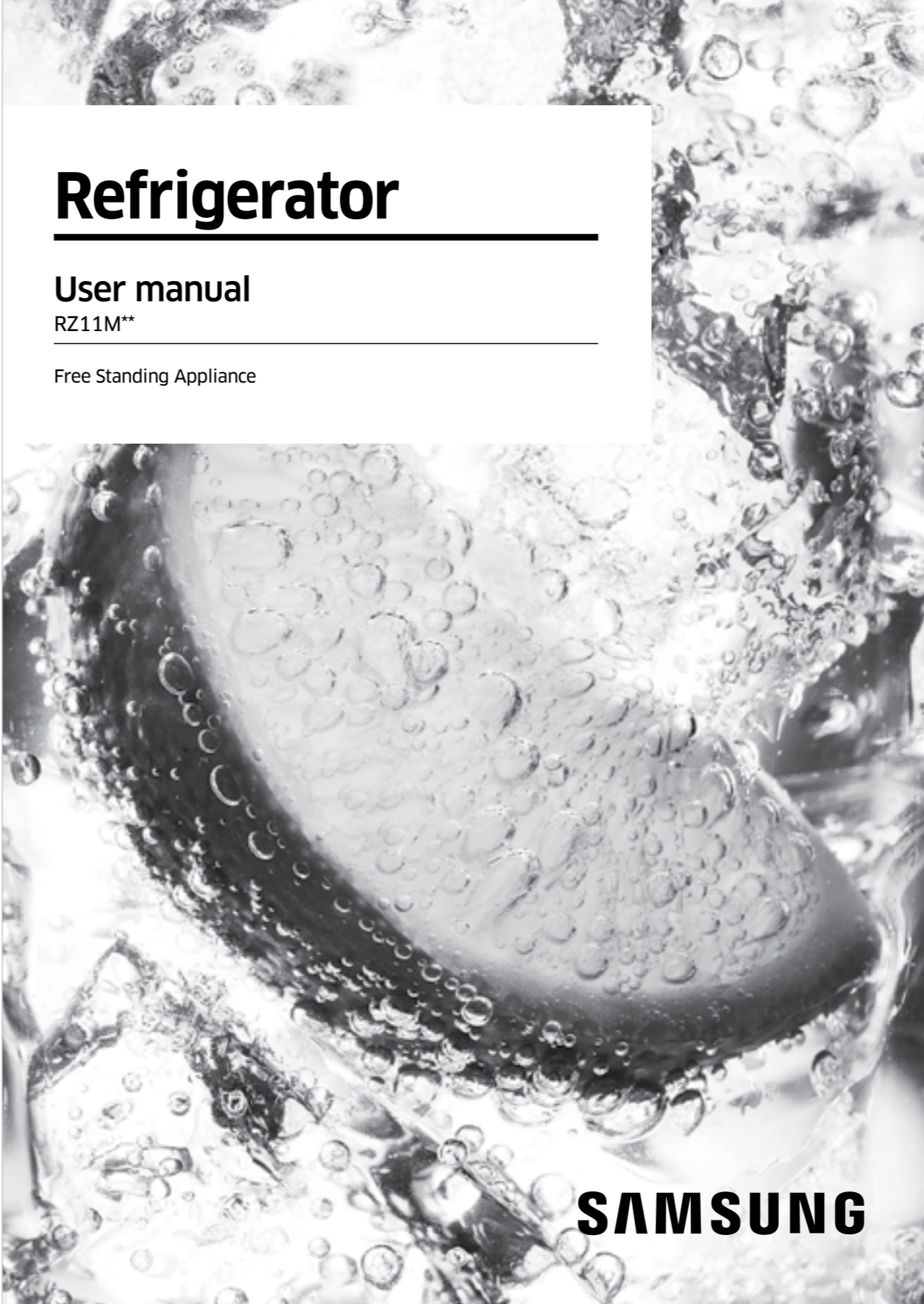

## Refrigerator

### User manual

RZ11M\*\*

Free Standing Appliance

**SAMSUNG**

User Manual

# Feature Icons

---

**RZ11M7074SA – 11.4 cu. ft. Capacity Convertible Upright Freezer**

# Feature Icons

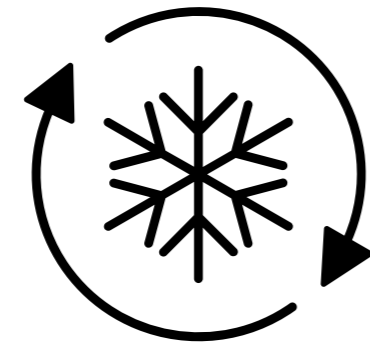

All-Around Cooling



High-Efficiency  
LED Lighting



ENERGY STAR®  
Certified



FlexZone™

**SAMSUNG**