

Frigidaire Gallery



Single Wall Oven

27" Single Electric Wall Oven with Total Convection

GCWS2767AF, GCWS2767AD

Available Colors : Stainless Steel, Black Stainless Steel

Version : 08/21

Cooking Controls

Air Fry	Yes
Air Sous Vide	Yes
Bake	Yes
Bake Time	Yes
Broil	Yes
Cancel	Yes
Clock	Yes
Convection Bake	Yes
Convection Roast	Yes
Delay Start	Yes
Fast Preheat	Yes
Kitchen Timer	Yes
Light	Yes
My Favorite	Yes
Off	Yes
Oven Light	Yes
Preheat	Yes
Probe	Yes
Quick Preheat	Yes
Self Clean	Yes
Set Clock	Yes
Start	Yes
Start Time	Yes
Steam Bake	Yes
Steam Clean	Yes
Steam Roast	Yes
Stop	Yes
Temperature Display	Yes
Timer On / Off	Yes
User Preferences	Yes
Warm and Hold	Yes

Cooking Controls Function

Change between Continuous Bake Setting or 12-Hour Energy Saving Feature	Yes
Program Fahrenheit or Celsius	Yes

Silent Control Panel	Yes
----------------------	-----

Oven

Bake Element	2,500 Watts
Bake Element Pass	8
Bake Element Type	Hidden
Broil Element	4,000 Watts
Broil Element Pass	6
Broil System	Yes
Cleaning System	Yes
Convection	Yes
Convection Element	2,500 Watts
Convection Type	Total
Number of Convection Fans	1
Number of Rack Positions	5
Oven Interior Color	Midnight Black
Oven Light Quantity	2
Oven Light Type	Halogen
Oven Light Watts	40 Watts
Rack Position Type	Embossed
Rack Type 1	Handle
Rack Type 1 Quantity	2
Rack Type 2	Glide
Rack Type 2 Quantity	1

Controls

Control Lock	Yes
Sabbath Mode	Yes

Display

Control Location	Top
Display Interface Color	White
Display Light Color	White
Display Type	Capacitive Touch

Dimensions and Volume

Note: For planning purposes only. Always consult local and national electric, gas and plumbing codes.

Refer to Product Installation Guide for detailed installation instructions on the web at frigidaire.com / frigidaire.ca

Specifications subject to change. Accessories information available on the web at frigidaire.com / frigidaire.ca

USA • 10200 David Taylor Drive • Charlotte, NC 28262 • 1-800-FRIGIDAIRE • frigidaire.com

CANADA • 5855 Terry Fox Way • Mississauga, ON L5V 3E4 • 1-800-265-8352 • frigidaire.ca

Frigidaire Gallery

27" Single Electric Wall Oven with Total Convection GCWS2767AF, GCWS2767AD

Version : 08/21

Height	29 1/2"
Width	27"
Depth	24 3/4"
Depth With Door 90° Open	45 3/4"
Depth With Handle	27 7/16"
Oven Interior Height	17"
Oven Interior Width	20 1/2"
Oven Interior Depth	18 3/4"
Minimum Cutout Height	27 1/4"
Minimum Cutout Width	24 7/8"
Maximum Cutout Height	28 1/4"
Maximum Cutout Width	25 1/4"
Oven Capacity	3.8 Cu. Ft.

Electrical Specifications

Connected Load @ 240V	4.5 kW
Voltage Rating	240 V

Installation

Power Supply Connection Location	Top Right
----------------------------------	-----------

General Specifications

Prop 65 Label	Yes
Warranty - Labor	1 Year
Warranty - Parts	1 Year
Frigidaire Fit Promise	Yes

Certifications and Approvals

Star-K Certification	Yes
----------------------	-----

Safety Certifications and Approvals

UL Listed	Yes
RoHS	Yes

Note: For planning purposes only. Always consult local and national electric, gas and plumbing codes.

Refer to Product Installation Guide for detailed installation instructions on the web at frigidaire.com / frigidaire.ca

Specifications subject to change. Accessories information available on the web at frigidaire.com / frigidaire.ca

USA • 10200 David Taylor Drive • Charlotte, NC 28262 • 1-800-FRIGIDAIRE • frigidaire.com

CANADA • 5855 Terry Fox Way • Mississauga, ON L5V 3E4 • 1-800-265-8352 • frigidaire.ca

Frigidaire Gallery

27" Single Electric Wall Oven with Total Convection

GCWS2767AF, GCWS2767AD

Version : 08/21

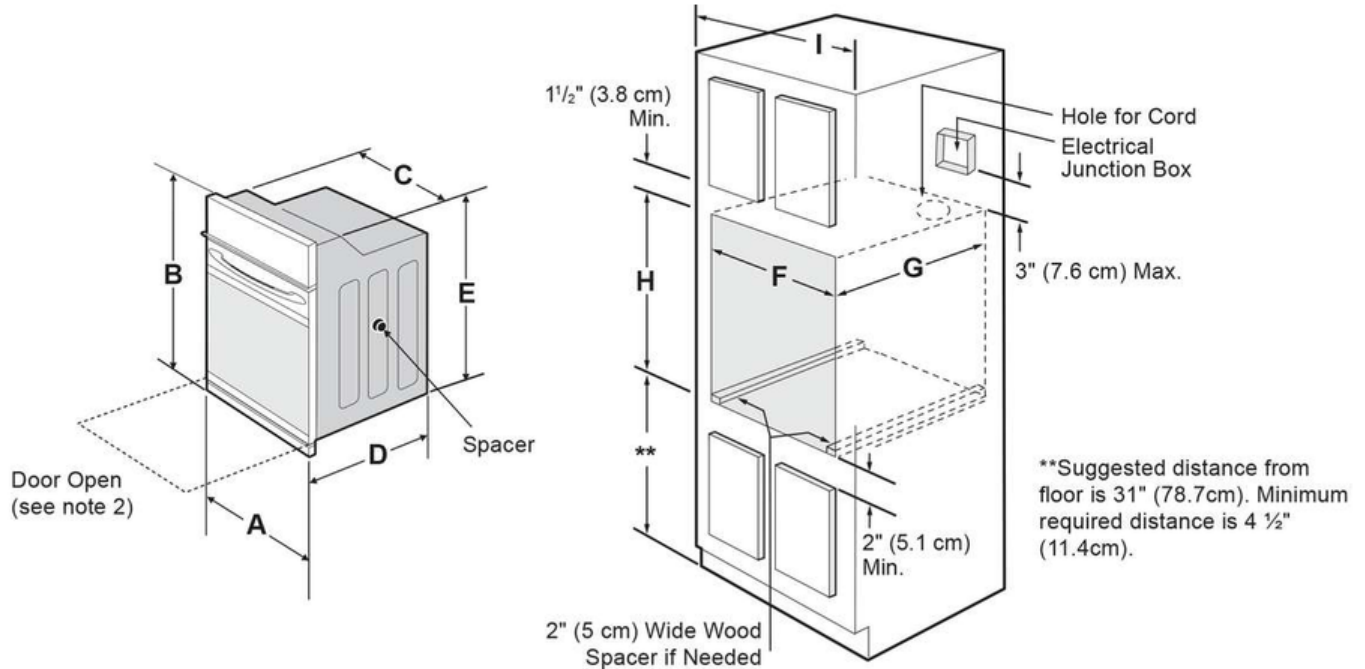

NOTES:

1. Allow at least 21" (53.3 cm) clearance in front of oven for door depth when it is open.
2. Dimension G (cutout depth) is critical to the proper installation of the built-in oven. If the oven trim does not butt against the cabinet, or if noise is heard on convection models, verify dimension G to assure it is the required depth.
3. For a cutout height greater than 27³/₄" (70.5) add 2" (5 cm) wide wood shims of appropriate height to each side of the opening under the appliance side rails. You can order a larger bottom trim through a service center.
4. If the junction box is below the oven, longer conduit cables are available through a service center.

PRODUCT DIMENSIONS					
A	B	C	D		E
27 (68.6)	29 ¹ / ₂ (74.9)	24 ⁵ / ₈ (62.5)	24 ³ / ₄ (62.9)		27 ¹ / ₄ (69.2)
CUTOUT DIMENSIONS AND CABINET WIDTH					
F		G	H. Standard Height (**Others, see note 3)		I
Min.	Max.	Min.	Min.	Max.	
24 ⁷ / ₈ (63.2)	25 ¹ / ₄ (64.1)	24 (61.0)	27 ¹ / ₄ (69.2)	28 ¹ / ₄ (71.8)	27 ¹ / ₈ (68.9) Min

Note: For planning purposes only. Always consult local and national electric, gas and plumbing codes.

Refer to Product Installation Guide for detailed installation instructions on the web at frigidaire.com / frigidaire.ca

Specifications subject to change. Accessories information available on the web at frigidaire.com / frigidaire.ca

USA • 10200 David Taylor Drive • Charlotte, NC 28262 • 1-800-FRIGIDAIRE • frigidaire.com

CANADA • 5855 Terry Fox Way • Mississauga, ON L5V 3E4 • 1-800-265-8352 • frigidaire.ca