

Dining Table



IMPORTANT

Carefully remove all the parts from the carton and place them individually on a soft cloth to prevent scratches or other damage.

Carefully and strictly follow these assembly instructions to ensure a completed product as designed.

This product is made of aluminum. Do not use power tools above 8 volts to assemble and only tighten bolts until snug. Over tightening can damage the aluminum.

Part List

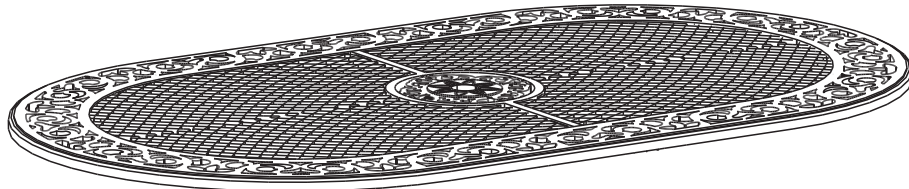

A.
Top
1 pc.

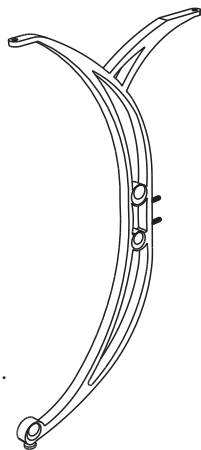

B.
Leg
4 pcs.



C.
Stretcher
1 pc.

Hardware List



Hex Wrench
1 pc.

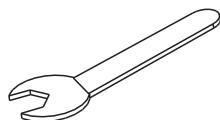

Wrench
1 pc.



Spring Washer
16 pcs. (+1 extra)

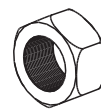

Nut
16 pcs. (+1 extra)



Small Hex Wrench
1 pc.

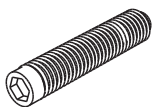

M8x30
Bolt
8 pcs. (+1 extra)



Flat Washer
16 pcs. (+1 extra)



Cap
16 pcs. (+1 extra)



Cover
1 pc.

Tool(s) required for assembly: Level

Assembly Instructions 2/3

IMPORTANT

- Use a soft cloth between these parts and the floor.
- Do not use power tools above 8 volts to assemble.
- Do not tighten all the bolts until each part is properly assembled.
- The unit must be level to work properly. Use the included adjustable levelers to level.
- Keep Wrench and Hex Wrench as the bolts and nuts may need to be tightened in the future.

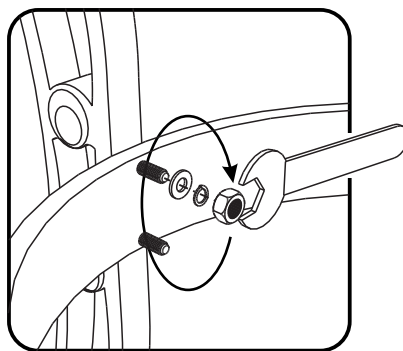
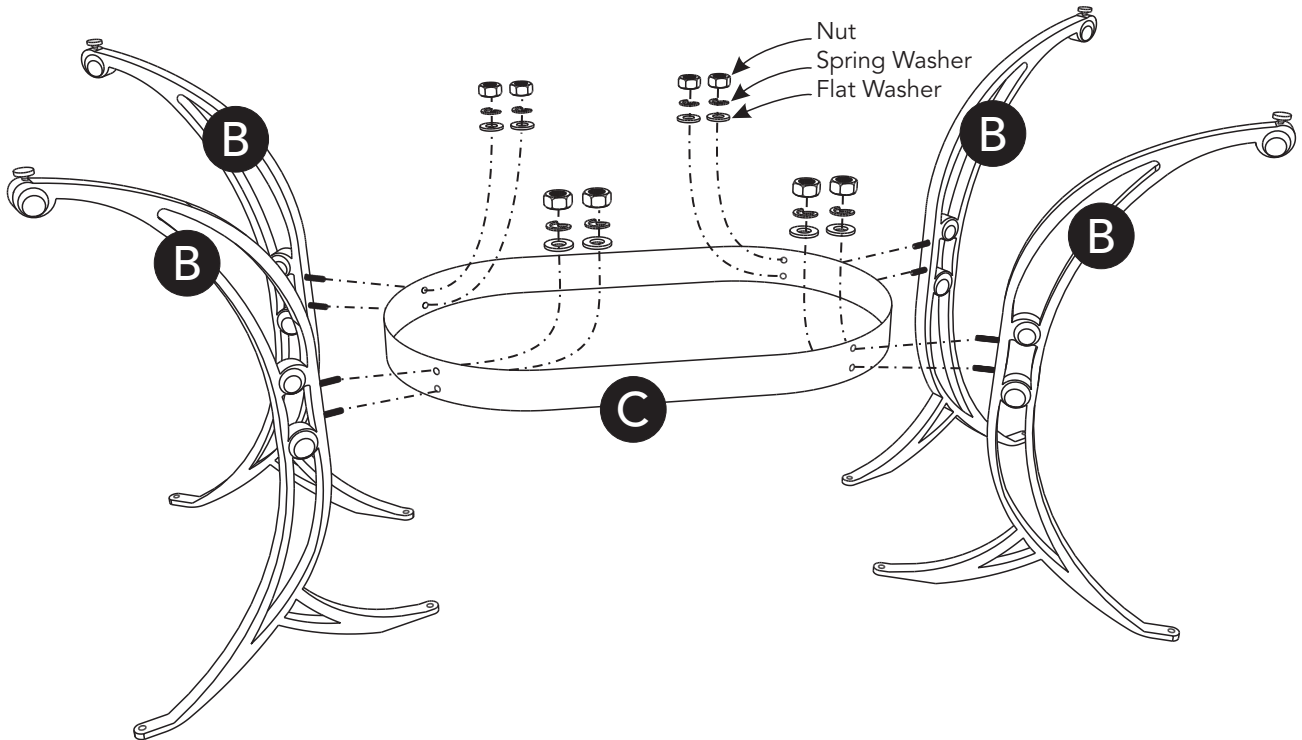

Figure 1

STEP 1

Attach Legs (B) to Stretcher (C) with Flat Washers, Spring Washers and Nuts, tightening Nuts only halfway. (See Figure 1)

Assembly Instructions 3/3



Figure 2

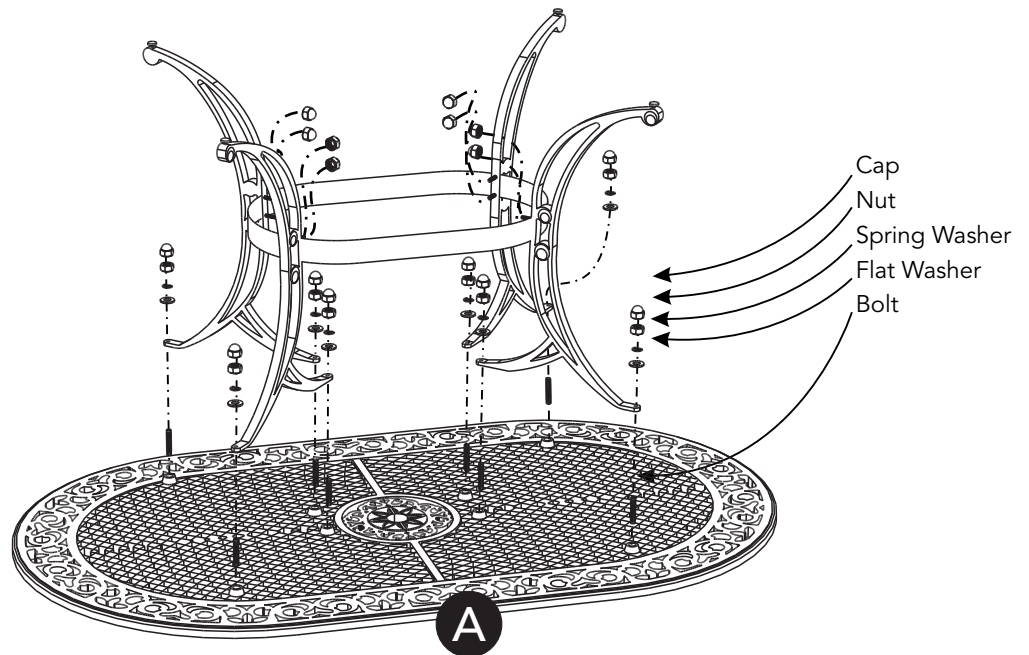

STEP 2

Place Top (A) upside down on a soft cloth.

Insert Bolts into pre-drilled holes in Top (A), then tighten. (See Figure 2)

Attach unit to Top (A) with Flat Washers, Spring Washers and Nuts, tightening Nuts only halfway.

Tighten all Nuts used in Steps 1 and 2.

Cover all Nuts with Caps.

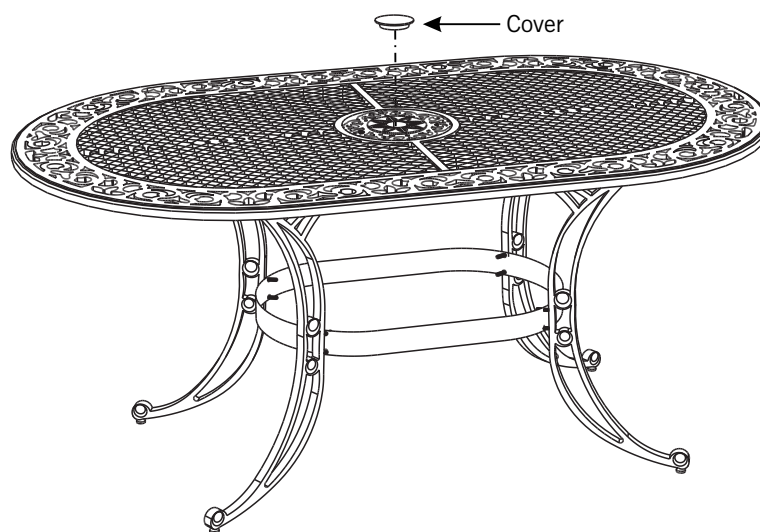

STEP 3

Turn table over to its upright position.

Cover umbrella hole with Cover.

Level table by adjusting the adjustable levelers on bottom of legs. (See Figure 3)

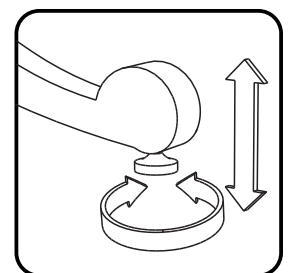

Figure 3

CARE INSTRUCTIONS

NEVER

allow liquids to remain on furniture.
Absorption causes parts to warp
and split and finishes to delaminate.

NEVER

use glass cleaners on
finished furniture. Ammonia
chemically attacks the finish.



Do not use power tools
above 8 volts to assemble.

**PREVENT
CRACKING**



Do not place
in direct sunlight.

**PREVENT
FADING**



Do not write
directly on surface.

**PREVENT
MARKING**



Do not place hot
objects on surface.

**PREVENT
FINISH DAMAGE**



Do not use rubber
based placemats.

**PREVENT
DISCOLORING**



Do not use commercial
waxes and polishes.

**PREVENT
YELLOWING**

CLEAN

with a soft cloth moistened
in lukewarm soap and water.
Buff with a dry clean cloth.



homestyles will provide replacements free of charge for missing or damaged parts within 2 years of purchase. Digital images of the defective parts may be required. If the product was not purchased from an authorized retailer, **homestyles** is under no obligation to provide replacement parts. Parts are not available for fully assembled items nor are parts available for sale. Replacements for missing or damaged parts may be requested via contact info below.

homestyles Customer Service: www.homestylesfurniture.com,
servicedesk@homestylesfurniture.com, 888-680-7460

Swivel Chair

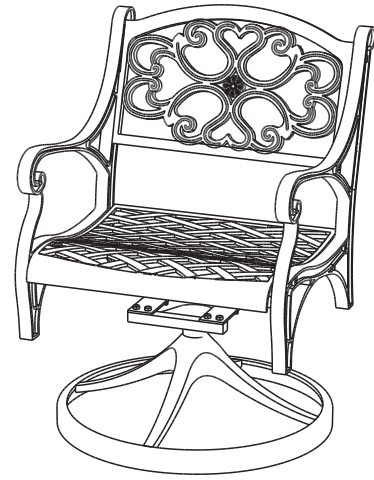

IMPORTANT

Carefully remove all the parts from the carton and place them individually on a soft cloth to prevent scratches or other damage.

Carefully and strictly follow these assembly instructions to ensure a completed product as designed.

This product is made of aluminum. Do not use power tools above 8 volts to assemble and only tighten bolts until snug. Over tightening can damage the aluminum.

Part List

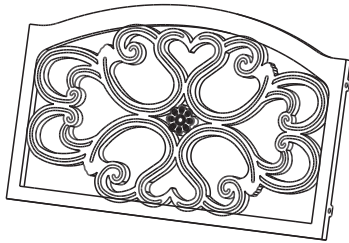

D.
Back
1 pc.

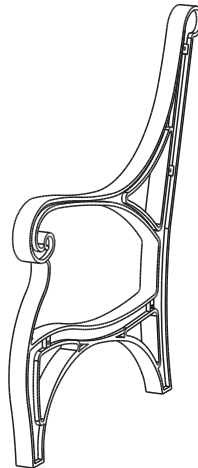

F.
Side Frame
1 pc.

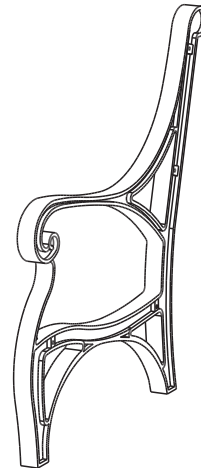

G.
Side Frame
1 pc.

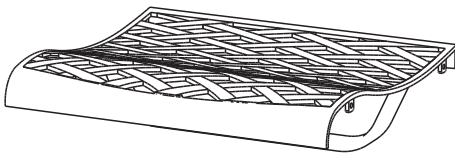

E.
Seat
1 pc.

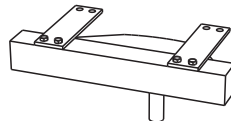

B.
Connector
1 pc.

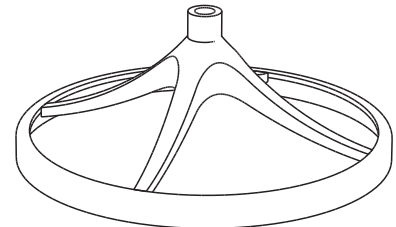

C.
Base
1 pc.

Hardware List



Small
Hex Wrench
1 pc.



Hex Wrench
1 pc.

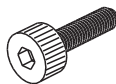

M6x20
Head Cap Bolt
8 pcs. (+1 extra)



Flat Washer
8 pcs. (+1 extra)



Spring Washer
8 pcs. (+1 extra)



Cap
8 pcs. (+1 extra)

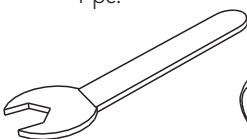

Wrench
1 pc.

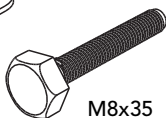

M8x35
Bolt
4 pcs. (+1 extra)



Flat Washer (long)
4 pcs. (+1 extra)



Spring Washer (large)
4 pcs. (+1 extra)



Nut
4 pcs. (+1 extra)



Cap (large)
8 pcs. (+1 extra)

Assembly Instructions 2/3

IMPORTANT

- Use a soft cloth between these parts and the floor.
- Do not use power tools above 8 volts to assemble.
- Do not tighten all the bolts until each part is properly assembled.
- The unit must be level to work properly. Use the included adjustable levelers to level.
- Keep Wrench as the bolts may need to be tightened in the future.

STEP 1

Place Side Frame (F) on a soft cloth.

Attach Back (D) and Seat (E) to Side Frame (F) with Flat Washers, Spring Washers and Head Cap Bolts, tightening bolts only halfway. (See Figure 1)

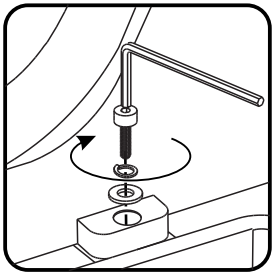
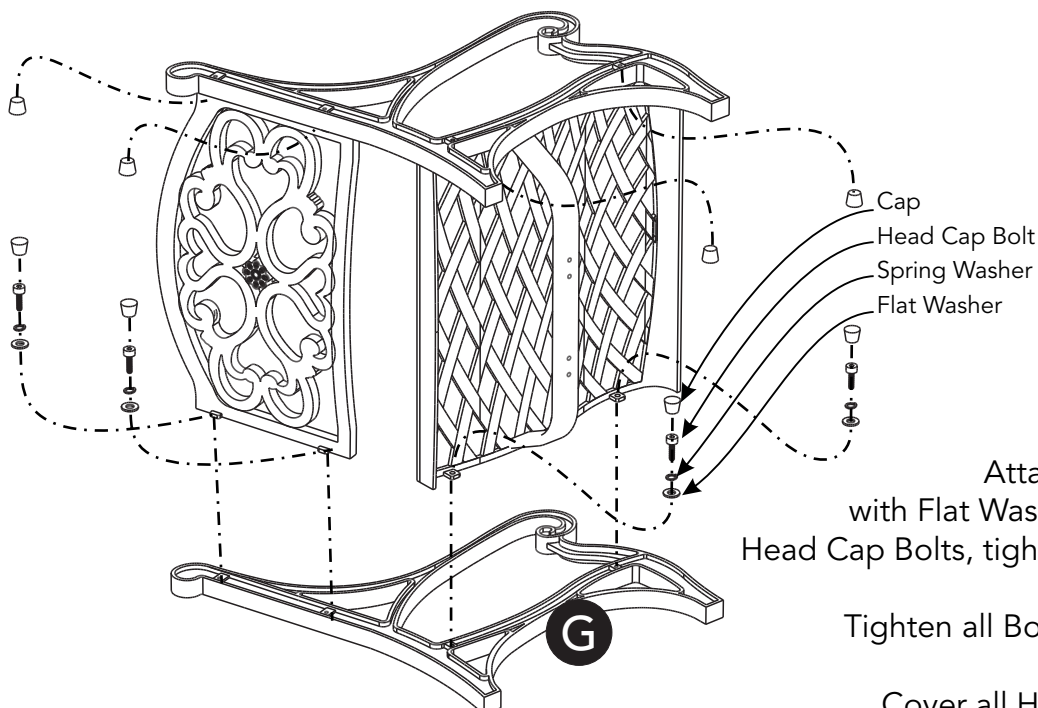
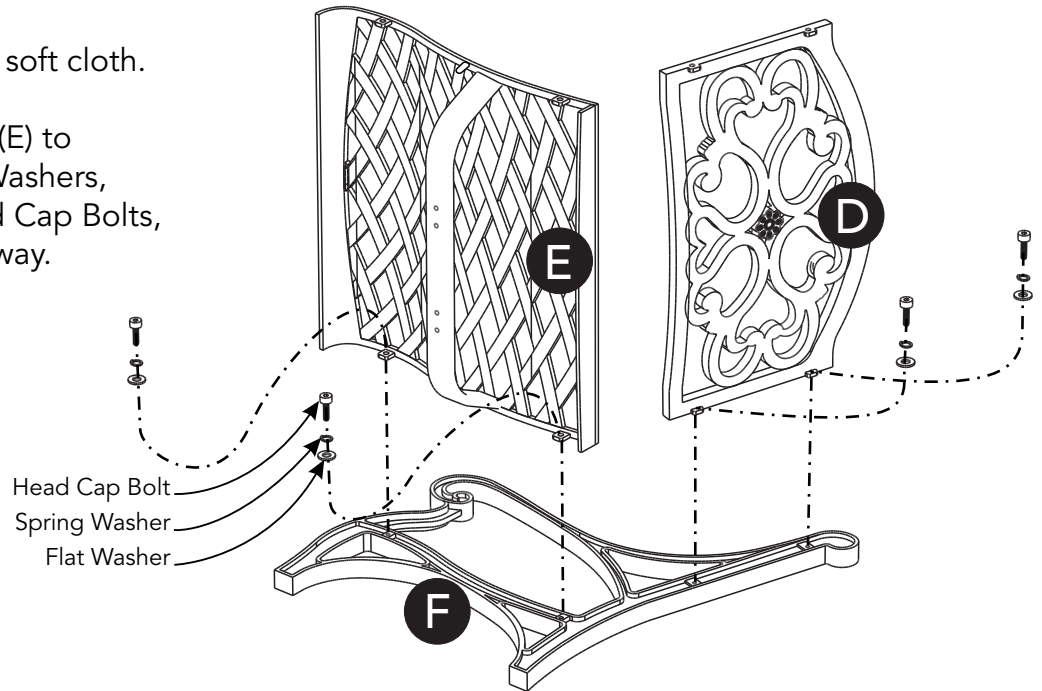

Figure 1



STEP 2

Place Side Frame (G) on a soft cloth.

Attach unit to Side Frame (G) with Flat Washers, Spring Washers and Head Cap Bolts, tightening bolts only halfway.

Tighten all Bolts used in Steps 1 and 2.

Cover all Head Cap Bolts with Caps.

Assembly Instructions 3/3

STEP 3

Attach unit to Connector (B) with Bolts, Flat Washers (long), Spring Washers (large) and Nuts, tightening bolts and nuts only halfway. (See Figure 2)

Tighten all Bolts and Nuts.

Cover all Bolts and Nuts with Caps (large).

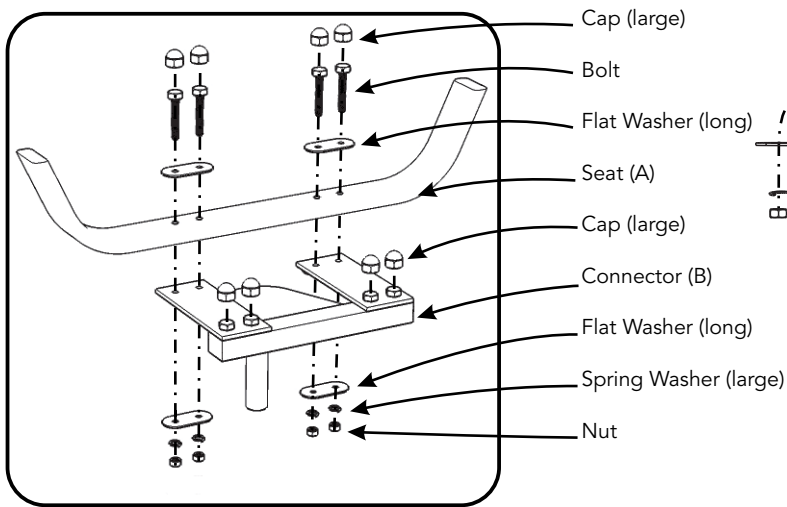
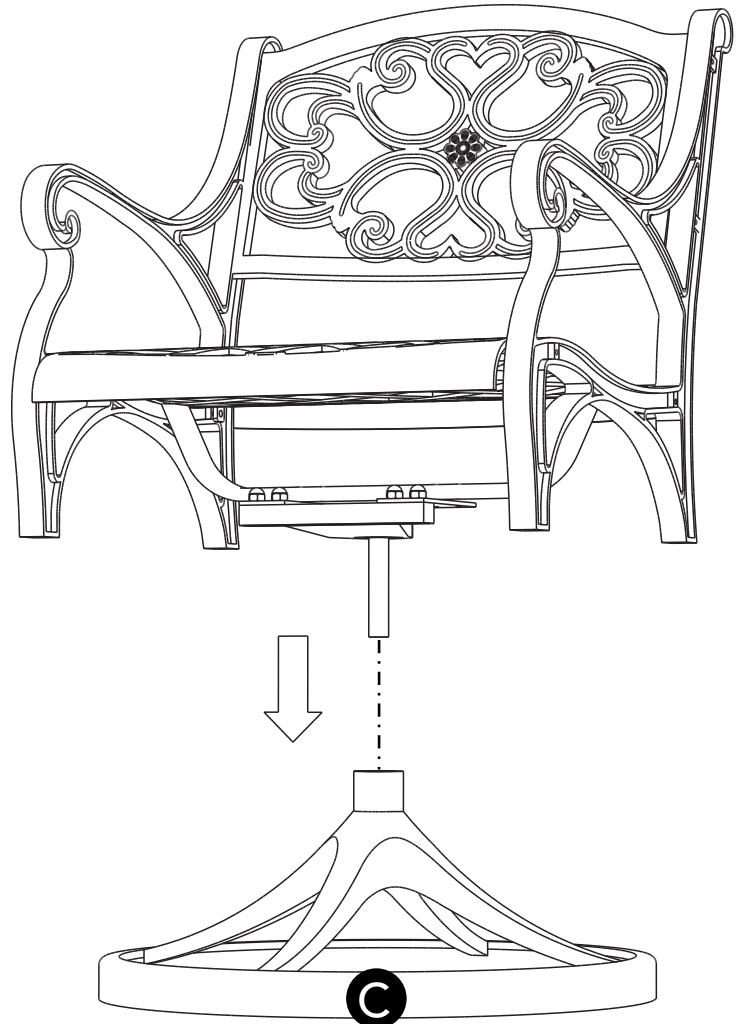
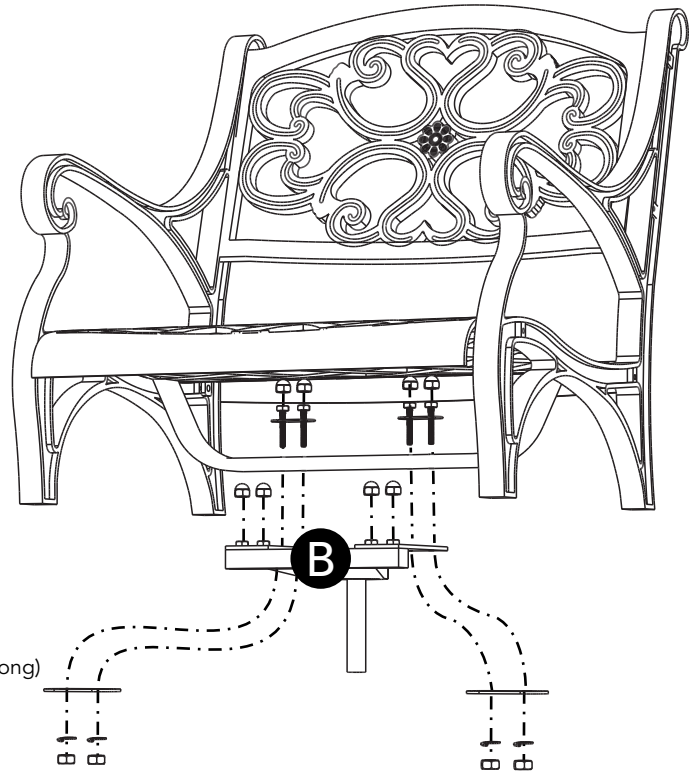

Figure 2



STEP 4

Place unit onto Base (C).

CARE INSTRUCTIONS

NEVER

allow liquids to remain on furniture.
Absorption causes parts to warp
and split and finishes to delaminate.

NEVER

use glass cleaners on
finished furniture. Ammonia
chemically attacks the finish.



Do not use power tools
above 8 volts to assemble.

**PREVENT
CRACKING**

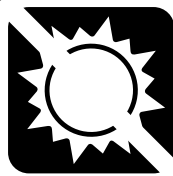

Do not place
in direct sunlight.

**PREVENT
FADING**



Do not write
directly on surface.

**PREVENT
MARKING**



Do not place hot
objects on surface.

**PREVENT
FINISH DAMAGE**

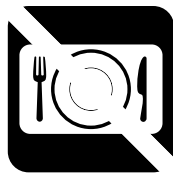

Do not use rubber
based placemats.

**PREVENT
DISCOLORING**



Do not use commercial
waxes and polishes.

**PREVENT
YELLOWING**

CLEAN

with a soft cloth moistened
in lukewarm soap and water.
Buff with a dry clean cloth.



homestyles will provide replacements free of charge for missing or damaged parts within 2 years of purchase. Digital images of the defective parts may be required. If the product was not purchased from an authorized retailer, **homestyles** is under no obligation to provide replacement parts. Parts are not available for fully assembled items nor are parts available for sale. Replacements for missing or damaged parts may be requested via contact info below.

homestyles Customer Service: www.homestylesfurniture.com,
servicedesk@homestylesfurniture.com, 888-680-7460