



Booklet available in English on
Livret disponible en français sur
Folleto disponible en español en



WE'RE MAKING OUR PACKAGING MORE SUSTAINABLE

We're transitioning from single-use plastic to paper-based packaging. As we progress, you may find a mix of paper and plastic in our boxes.

NOUS RENDONS NOS EMBALLAGES PLUS DURABLES

Nous passons des emballages en plastique à usage unique aux emballages à base de papier. Durant la transition, vous pourriez trouver un mélange de papier et de plastique dans nos boîtes.

QUEREMOS HACER MÁS SUSTENTABLES NUESTROS MATERIALES DE EMBALAJE

Estamos cambiando las bolsas de plástico desechables por bolsas con base de papel. Conforme avanzamos en este propósito, puedes encontrar una mezcla de papel y de plástico en nuestras cajas.

[LEGO.com/sustainable-packaging](https://www.lego.com/sustainable-packaging)

LEGO® VIP

- 1.** SIGN UP
INSCRIVEZ-VOUS
REGÍSTRATE

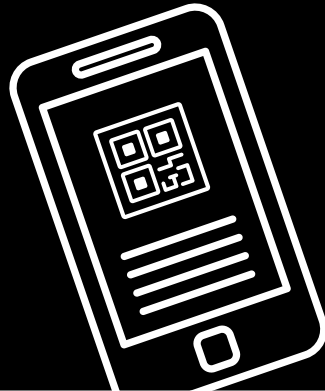

- 2.** EARN POINTS
FOR PURCHASES
GAGNEZ DES POINTS
POUR VOS ACHATS
GANA PUNTOS POR
TUS COMPRAS

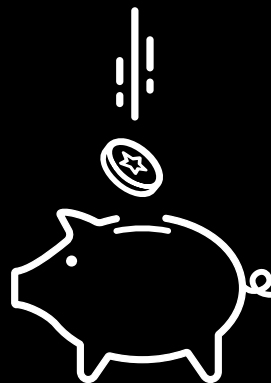

- 3.** REDEEM POINTS FOR REWARDS, EXPERIENCES,
DISCOUNTS & MORE
ÉCHANGEZ DES POINTS CONTRE DES RÉCOMPENSES,
DES EXPÉRIENCES, DES RÉDUCTIONS ET PLUS ENCORE
CANJEA PUNTOS POR RECOMPENSAS, EXPERIENCIAS,
DESCUENTOS Y MUCHO MÁS

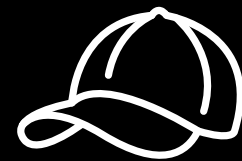
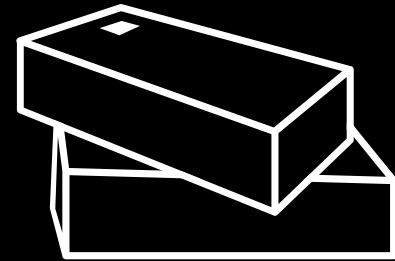
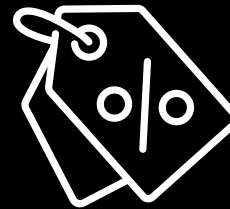



姫路城

HIMEJI CASTLE / THE CASTLE OF THE WHITE HERON

🏰 Majestically overlooking the Japanese city of Himeji, the breathtaking Himeji Castle is an architectural gem on UNESCO's World Heritage list. First built as a fortress in 1333, towards the end of an era of civil wars, the castle has undergone several transformations over the centuries. In 1600 a major reconstruction began, resulting in the current structure which has been preserved in its integrity until today, initially by feudal masters and later by the Japanese government. Mazes of intricate pathways once designed to confuse and trap enemies now weave an intriguing journey for visitors. Through wars, earthquakes, fires and times of peace, the Castle of the White Heron stands as a serene monument to Japanese culture. Discover the intricate details of the Main Keep and the history of the castle as you build.

LE CHÂTEAU DE HIMEJI / LE CHÂTEAU DU HÉRON BLANC

🏰 Surplombant majestueusement la ville japonaise de Himeji, l'époustouflant château de Himeji est un joyau architectural inscrit sur la liste du patrimoine mondial de l'UNESCO. D'abord construit comme une forteresse en 1333, vers la fin d'une époque de guerres civiles, le château a subi plusieurs transformations au fil des siècles. En 1600, une reconstruction majeure a été entreprise, donnant naissance à la structure qui a été préservée dans son intégrité jusqu'à aujourd'hui, d'abord par les maîtres féodaux, puis par le gouvernement japonais. Les dédales de chemins complexes autrefois conçus pour confondre et piéger les ennemis tissent aujourd'hui un parcours intrigant pour les visiteurs. À travers les guerres, les tremblements de terre, les incendies et les périodes de paix, le château du héron blanc se dresse comme un monument serein de la culture japonaise. Découvrez les détails complexes du donjon principal et l'histoire du château au fur et à mesure de la construction.

CASTILLO DE HIMEJI / CASTILLO DE LA GARZA BLANCA

🏰 Con el panorama más majestuoso de la ciudad japonesa de Himeji, el impresionante Castillo de Himeji es una gema arquitectónica a la que la UNESCO ha declarado Patrimonio de la Humanidad. Construido originalmente como una fortaleza en 1333 con la intención de poner fin a una era de guerras civiles, el castillo ha sufrido múltiples transformaciones a lo largo de los siglos. En el año 1600 se inició una importante reconstrucción que tuvo como resultado la estructura que conocemos hoy, de cuya preservación se encargaban inicialmente los señores feudales y, en fechas más recientes, el Gobierno japonés. Laberintos de embrollados senderos diseñados en su día para confundir y capturar a los intrusos ofrecen ahora un peculiar recorrido a los visitantes. El paso del tiempo ha traído guerras, terremotos, incendios y épocas de paz, y el Castillo de la Garza Blanca permanece como un sereno monumento a la cultura japonesa. Descubre los intrincados detalles de la torre mayor y la historia del castillo a medida que construyes.

A TRIBUTE TO A REVERED LANDMARK

🍷 "2023 marks the 30th anniversary of Himeji Castle's inscription to UNESCO's World Heritage list, and its architecture and history are still like a mystery to decode. We created the Main Keep as a natural focal point and played with proportions and scales to make it stand out. If you have visited the castle you may recognize some of the interiors, and if you haven't seen it in person, we hope it sparks your imagination and curiosity."

UN HOMMAGE À UN MONUMENT VÉNÉRÉ

🍷 « L'année 2023 marque le 30^e anniversaire de l'inscription du château de Himeji sur la liste du patrimoine mondial de l'UNESCO, et son architecture et son histoire sont toujours un mystère à percer. Nous avons créé le donjon principal comme un point focal naturel et joué avec les proportions et les échelles pour le mettre en valeur. Si vous avez visité le château, vous reconnaîtrez peut-être certains de ses intérieurs, et si vous ne l'avez pas vu en personne, nous espérons que cet ensemble éveillera votre imagination et votre curiosité. »

TRIBUTO A UN LUGAR EMBLEMÁTICO DE GRAN REVERENCIA

🍷 "No obstante que en 2023 se celebrará el 30 aniversario de la inscripción del Castillo de Himeji en la Lista del Patrimonio Mundial de la UNESCO, su arquitectura e historia siguen siendo en gran medida un misterio que hay que descifrar. Recreamos la torre mayor como el centro de atención natural y jugamos con las proporciones y escalas para hacerla resaltar aún más. Si has visitado el castillo, es muy probable que reconozcas algunos de los espacios interiores, y, si no lo has hecho, esperamos que el modelo sea una chispa que encienda la llama de tu imaginación y curiosidad".

CHRIS MCVEIGH
LEGO® Senior Designer
concepteur principal LEGO®
diseñador sénior de LEGO®





Follow some of the intricate pathways, ramps and stairways through the castle.

Suivez quelques-uns des chemins, rampes et escaliers complexes qui traversent le château.

Recorre algunos de los embrollados senderos, rampas y escaleras que hay en el castillo.



AN OPTICAL ILLUSION

🌸 Himeji Castle's roofing method uses interlocking black rectangular and semicircular tiles. Several layers of white clay line the tiles, giving the roofing a high-contrast, mesh-like appearance up close. However, at a distance, the mesh pattern appears gray. The roof tiles in this set are *Dark Stone Gray* to reflect the aging of the tiles.

UNE ILLUSION D'OPTIQUE

🌿 La méthode de toiture du château de Himeji utilise des tuiles noires rectangulaires et semi-circulaires imbriquées. Plusieurs couches d'argile blanche bordent les tuiles, ce qui donne à la toiture un aspect contrasté et maillé de près. Cependant, à distance, le motif de maillage semble gris. Les tuiles de cet ensemble sont de couleur *Gris pierre foncé* afin de reproduire le vieillissement des tuiles.

UNA ILUSIÓN ÓPTICA

🌿 Para hacer los techos del Castillo de Himeji se utilizaron tejas negras rectangulares y semicirculares entrelazadas. Las tejas están recubiertas con varias capas de arcilla blanca, lo que da al techo la apariencia de una retícula de alto contraste cuando se mira de cerca. No obstante, a la distancia solo se aprecia una superficie gris. Las tejas del techo de este set tienen un tono gris piedra oscuro para reflejar el envejecimiento.

Peek inside after the model is built.



Regardez à l'intérieur une fois le modèle construit.

Una vez que el modelo esté terminado, da un vistazo a su interior.

Each tower is constructed differently - even their heights.



Toutes les tours sont différentes, même au niveau de leur hauteur.

La construcción de cada una de las torres es diferente, e incluso tienen alturas distintas.

A mesh of black tiles and white clay makes the roof appear gray from a distance.



Un maillage de tuiles noires et d'argile blanche donne au toit un aspect gris de loin.

Una retícula conformada por tejas negras y arcilla blanca da al techo la apariencia de una superficie gris a la distancia.

Each layer or floor in the Main Keep evokes the actual structure of the castle.



Chaque couche ou étage du donjon principal évoque la structure réelle du château.

Cada una de las capas o niveles de la torre mayor evoca la estructura real del castillo.

Irregular angles are predominant throughout the castle and walls.

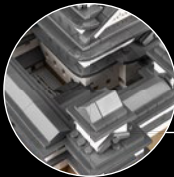

Les angles irréguliers sont prédominants dans le château et les murs.

En el castillo y sus muros predominan los ángulos irregulares.

Decorate the cherry trees with pink blossoms or green leaves.



Décorez les cerisiers avec des fleurs roses ou des feuilles vertes.

Decora los árboles de cerezo con flores de color rosa u hojas verdes.

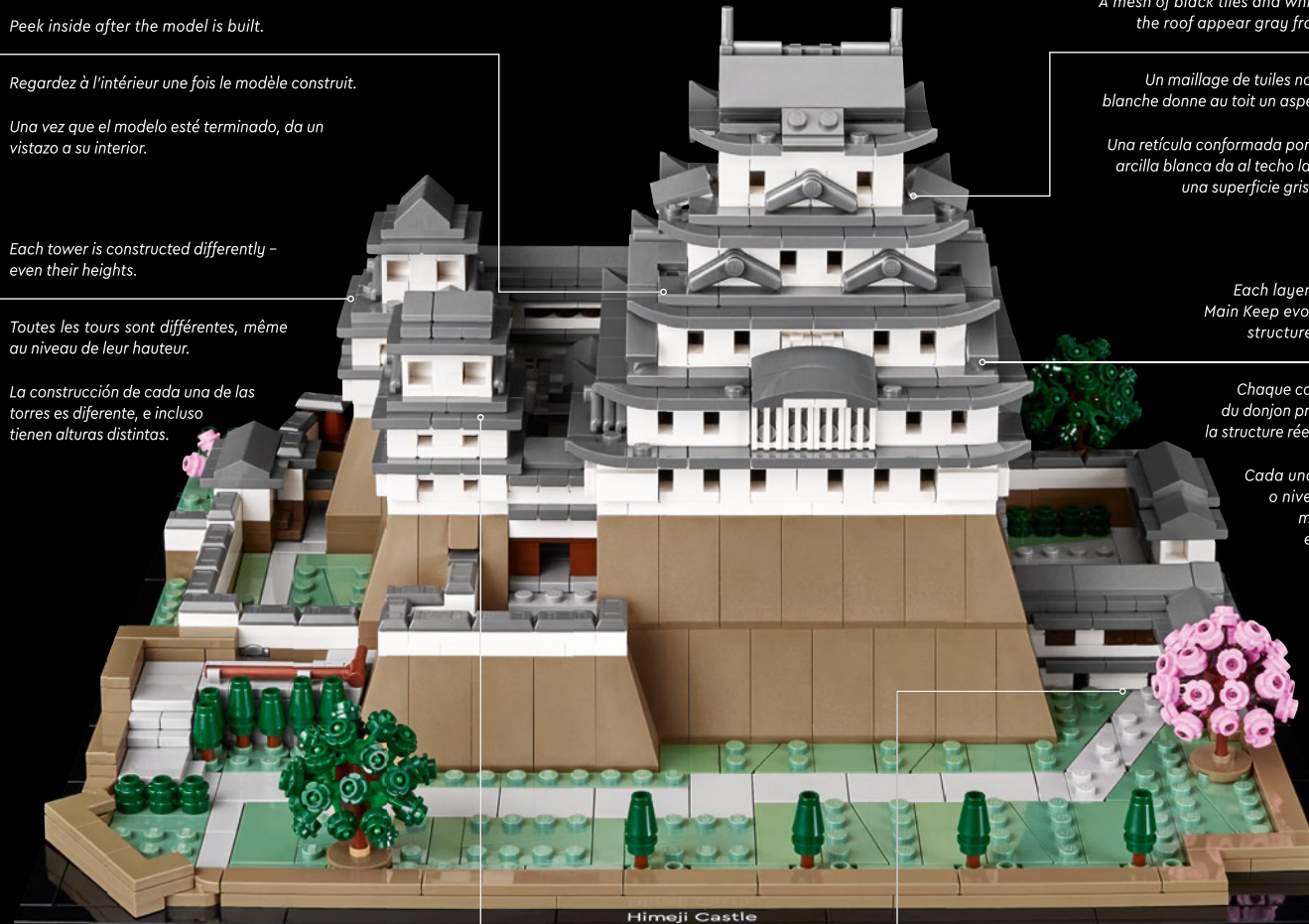

Himeji Castle

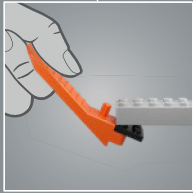
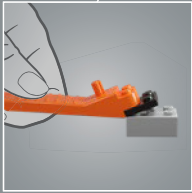
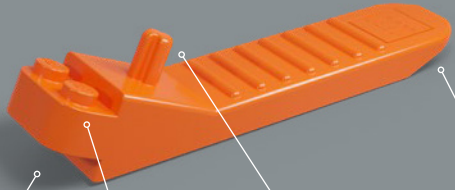

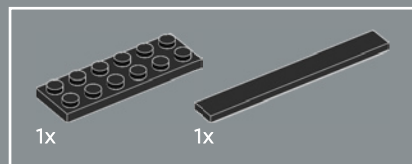

1

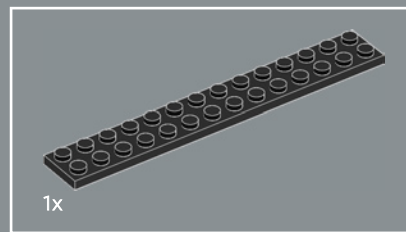
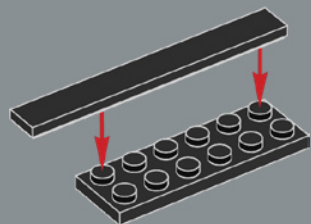

2

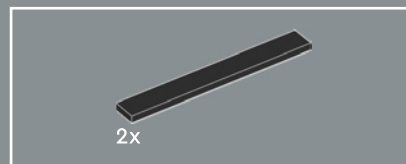
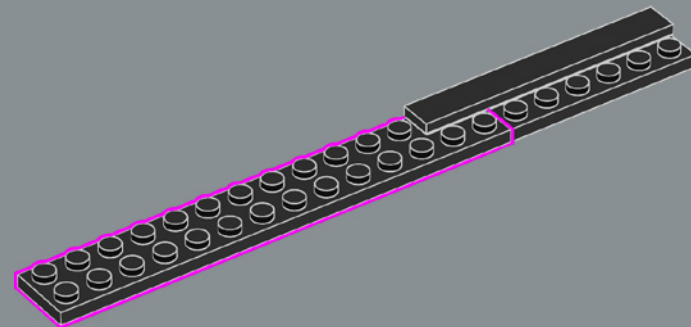

3

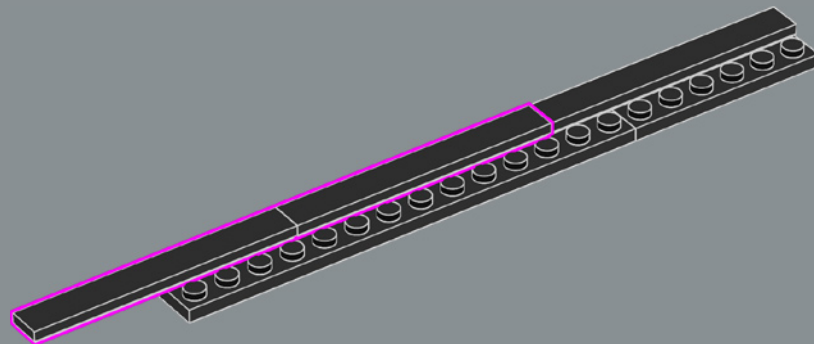

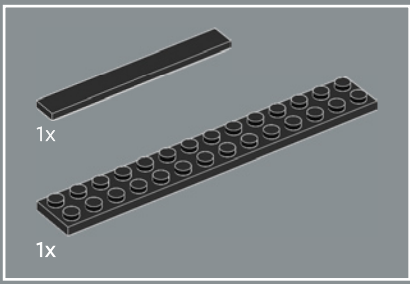

4

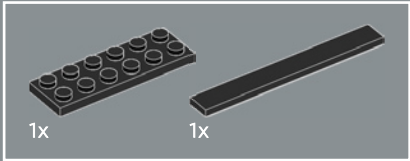
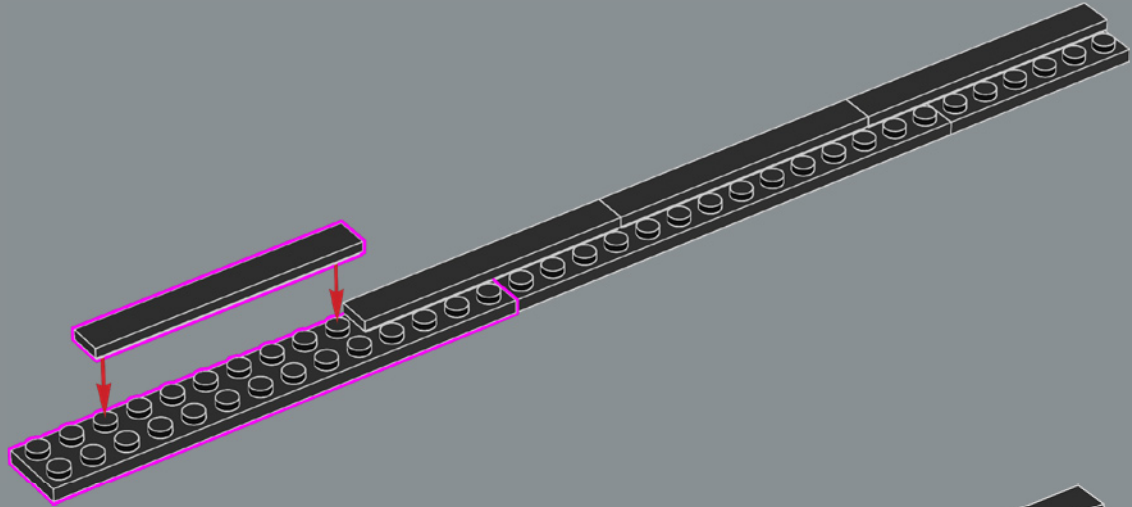

5

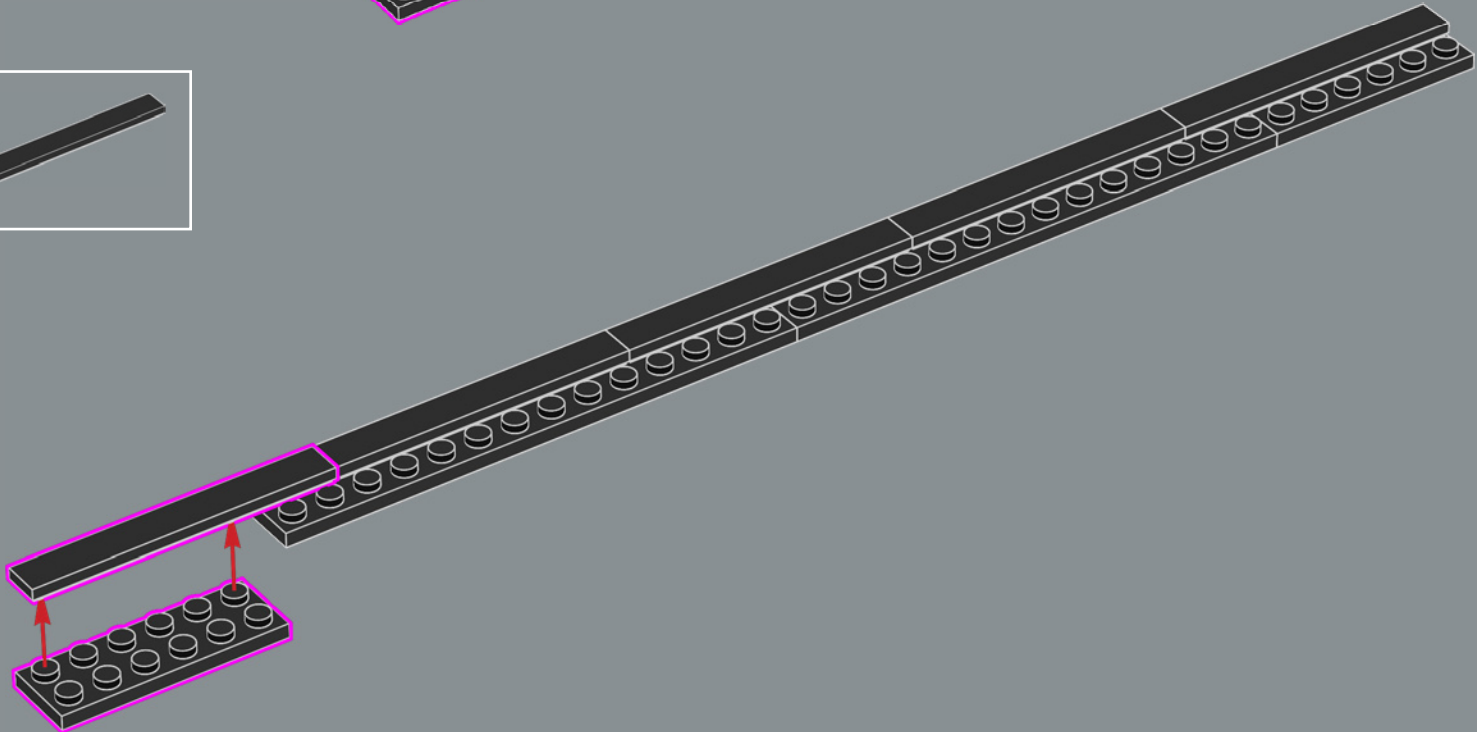

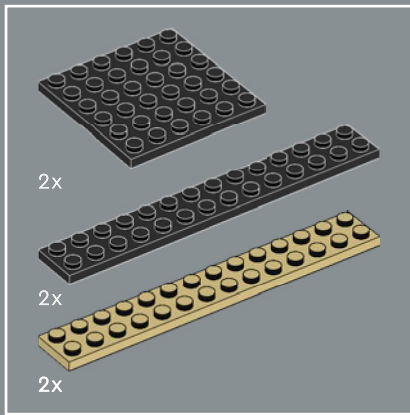

6

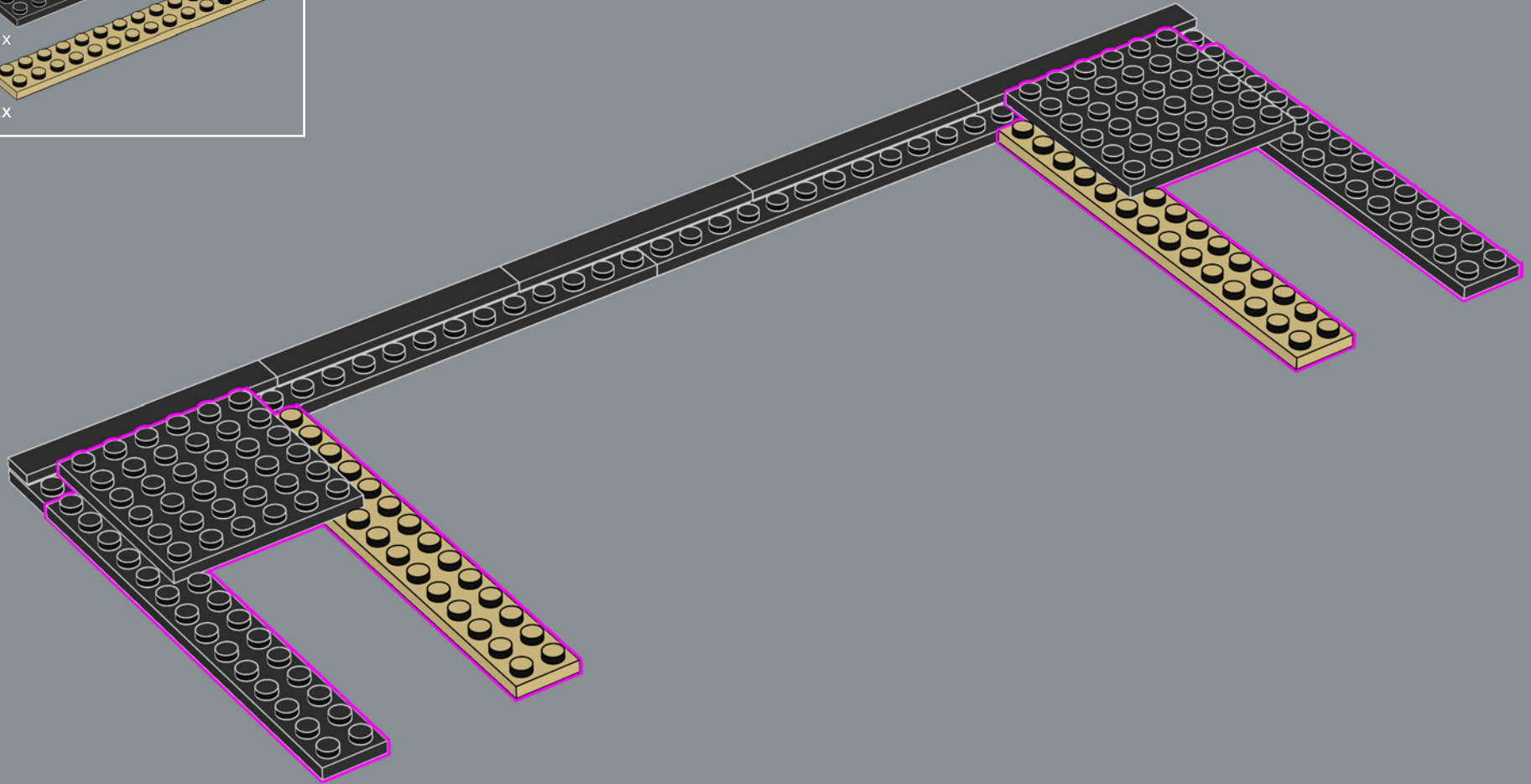

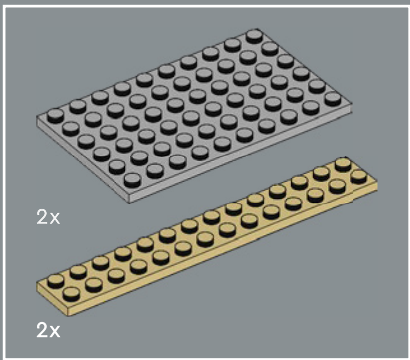

7

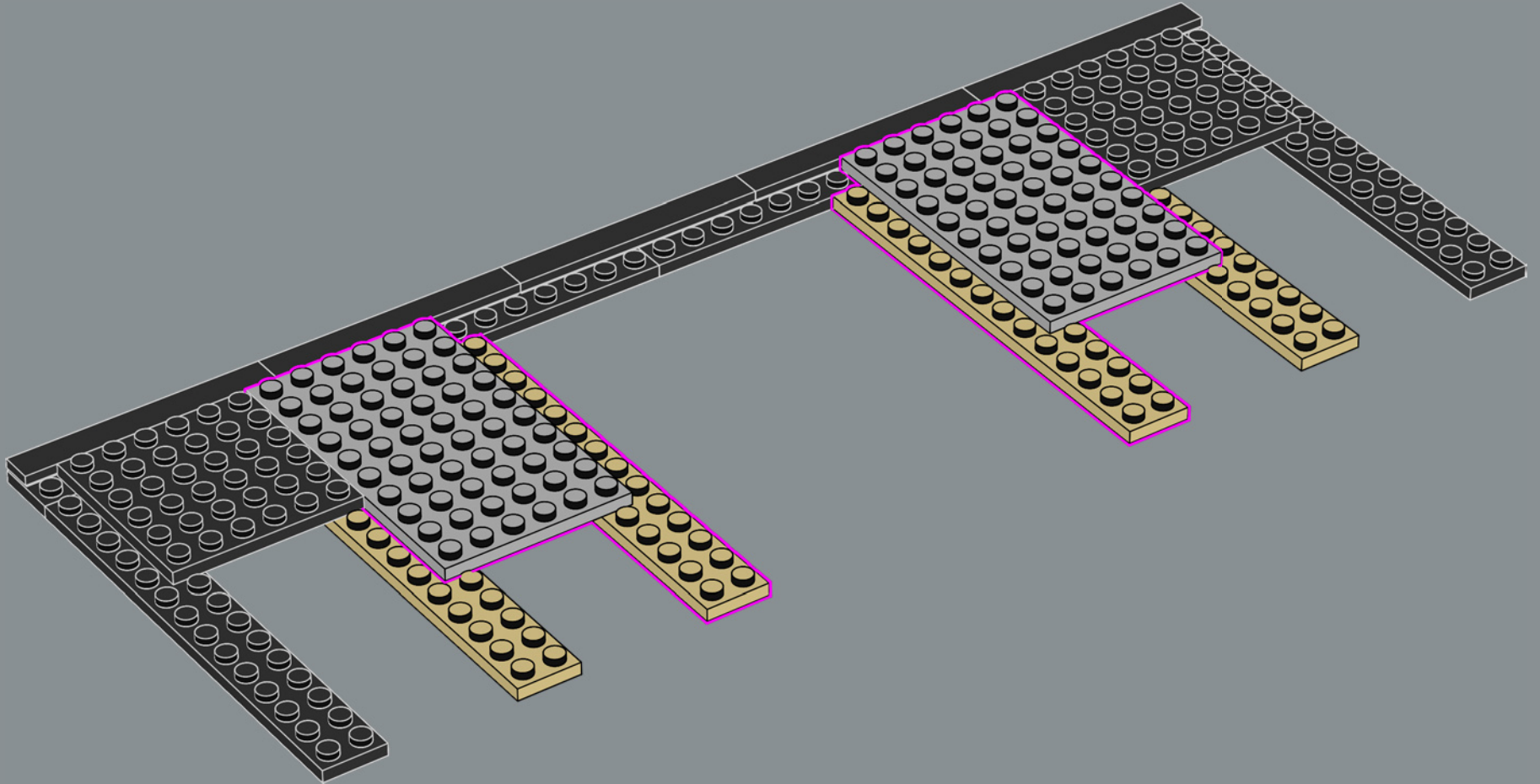

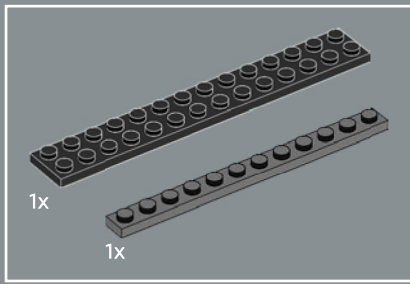

8

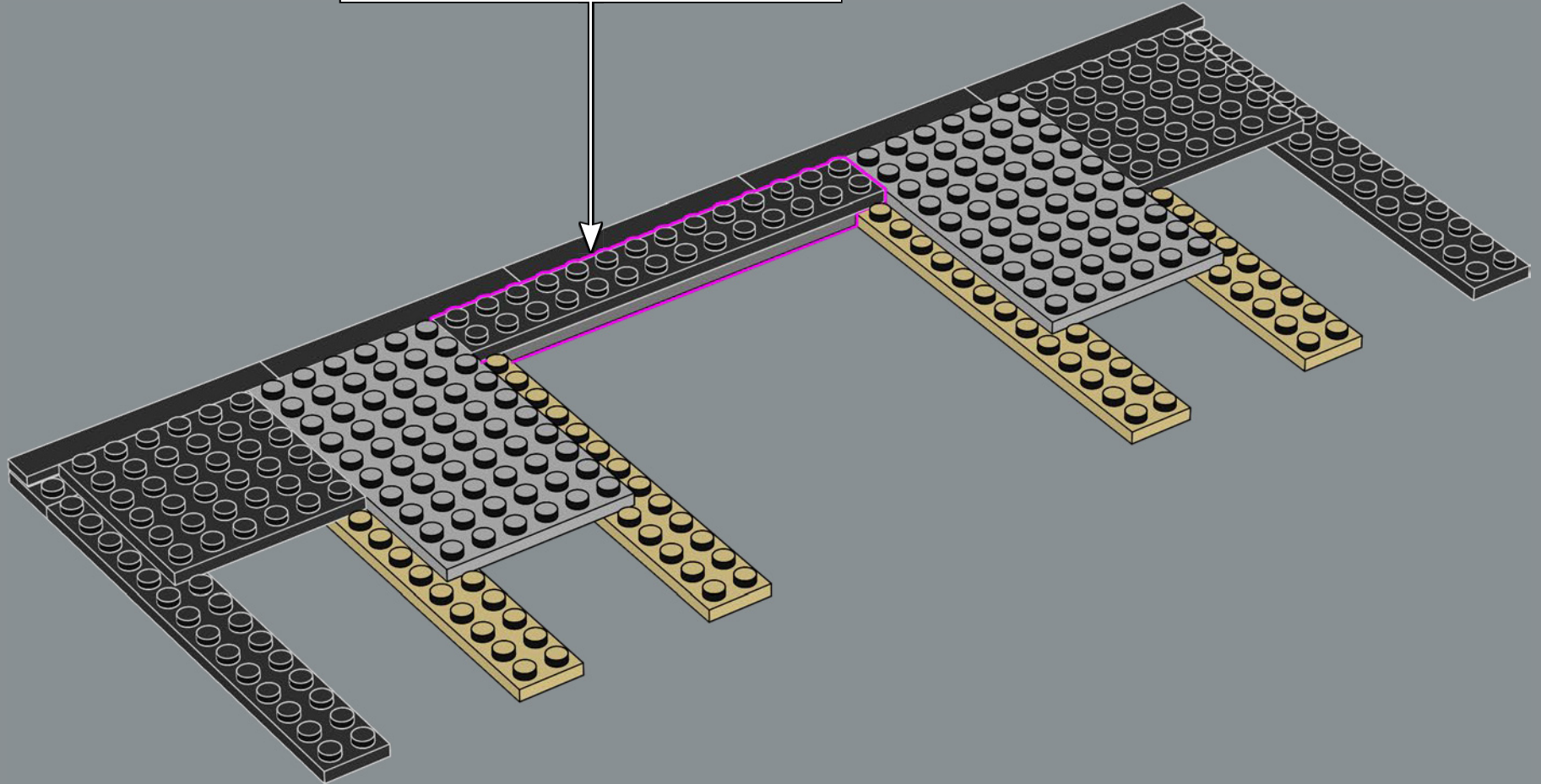
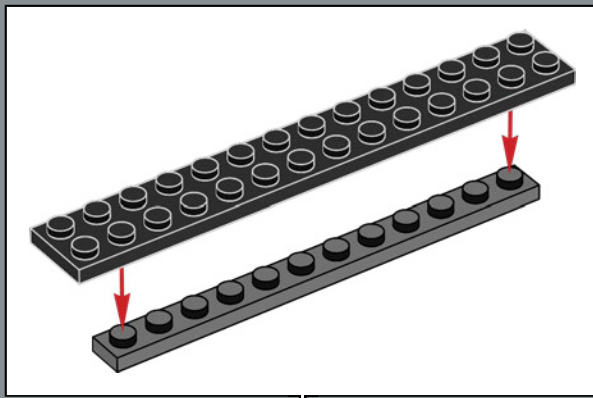

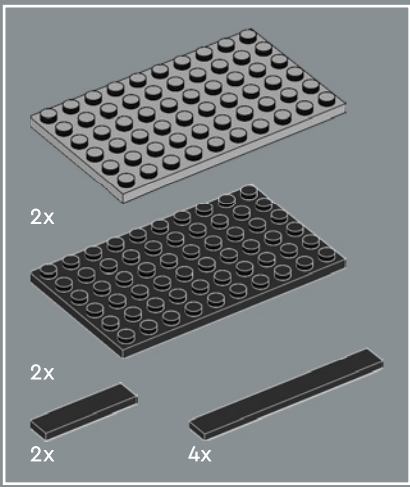

9

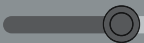
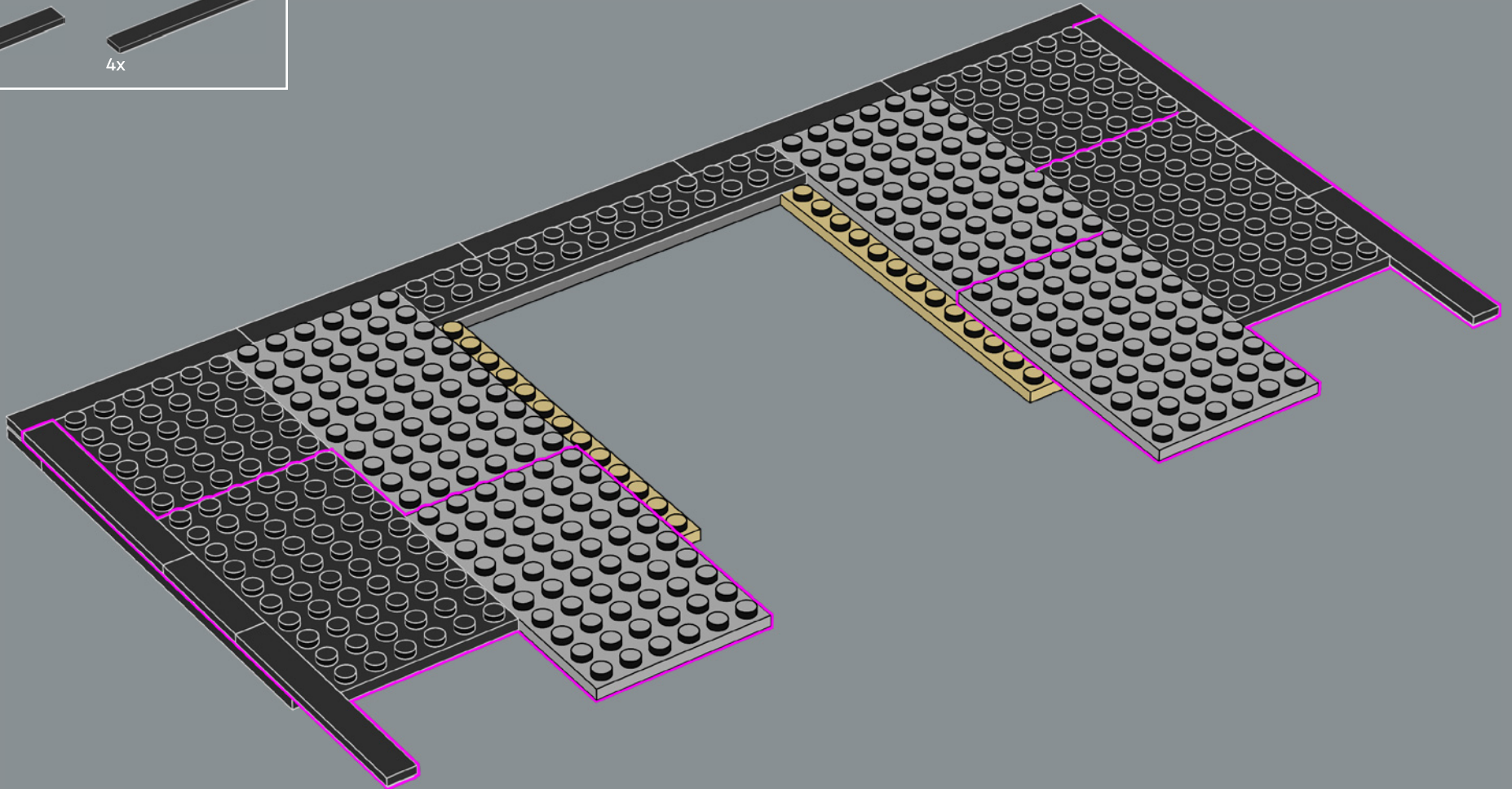

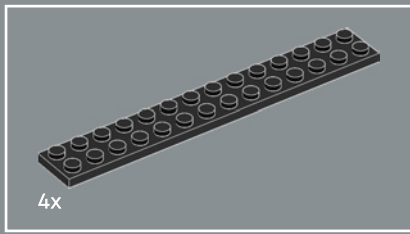

10

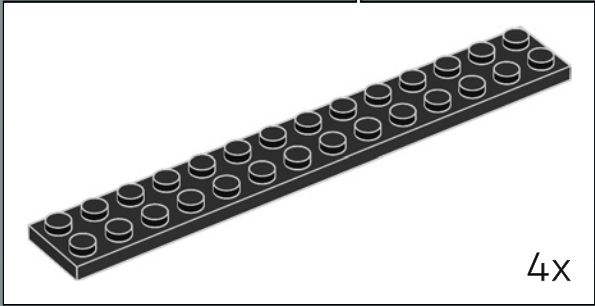
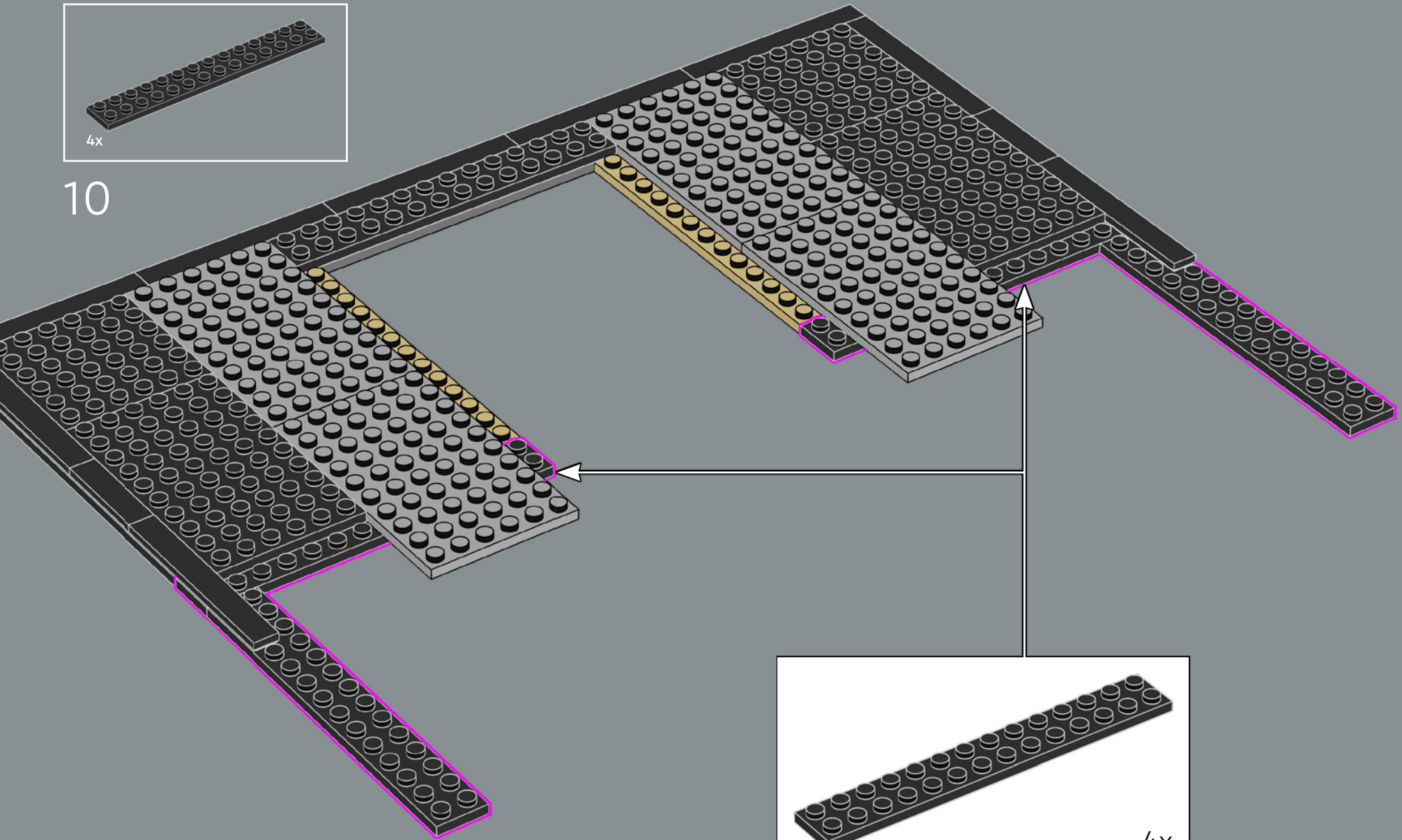

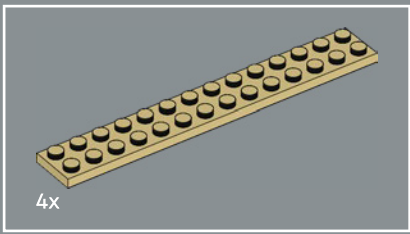

11

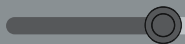
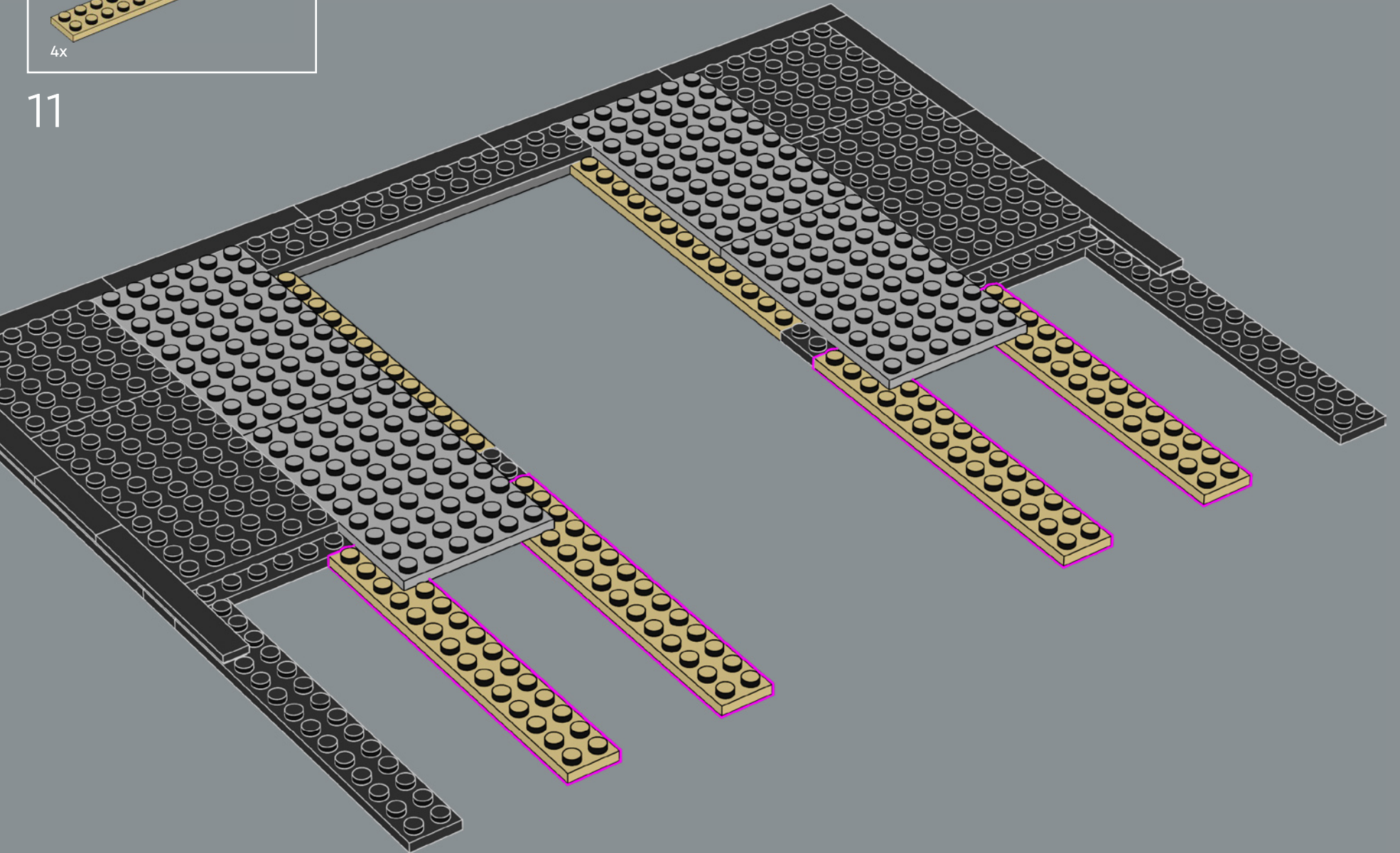

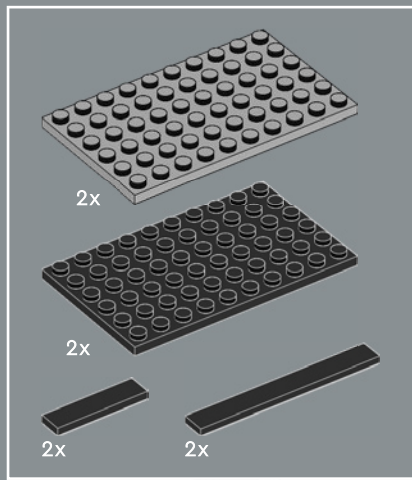

12

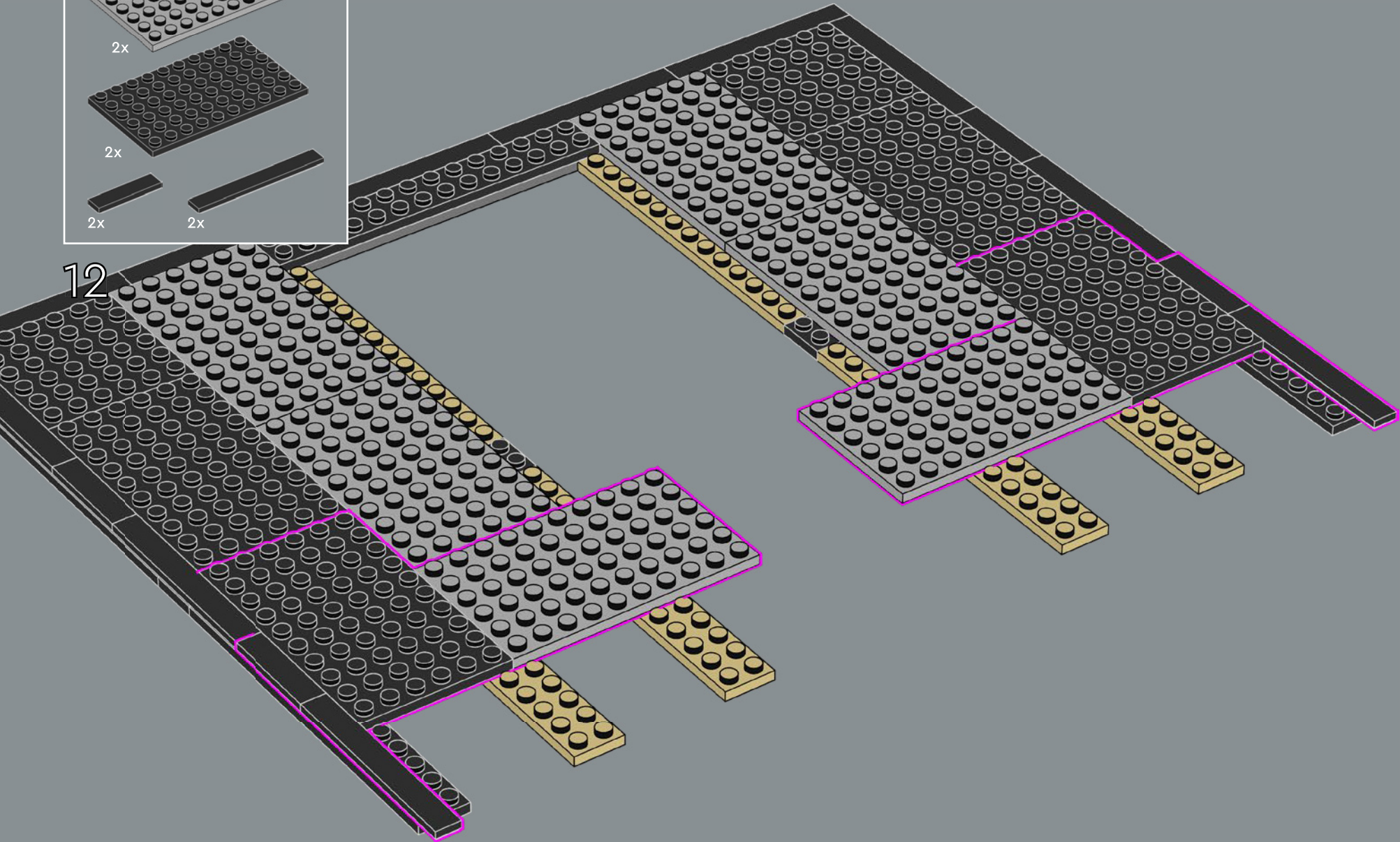

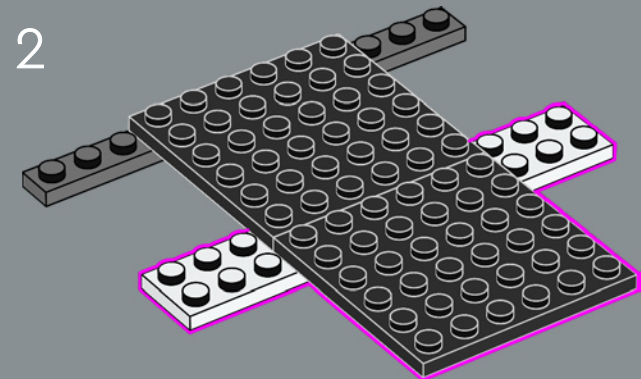
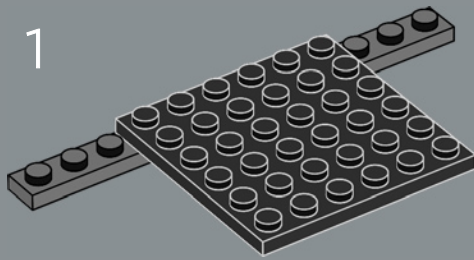
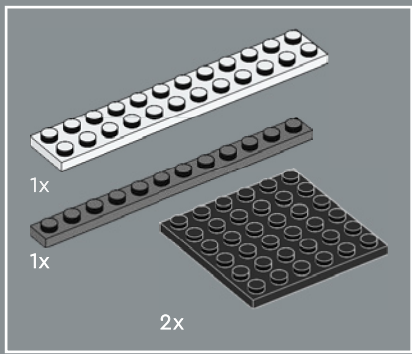

13

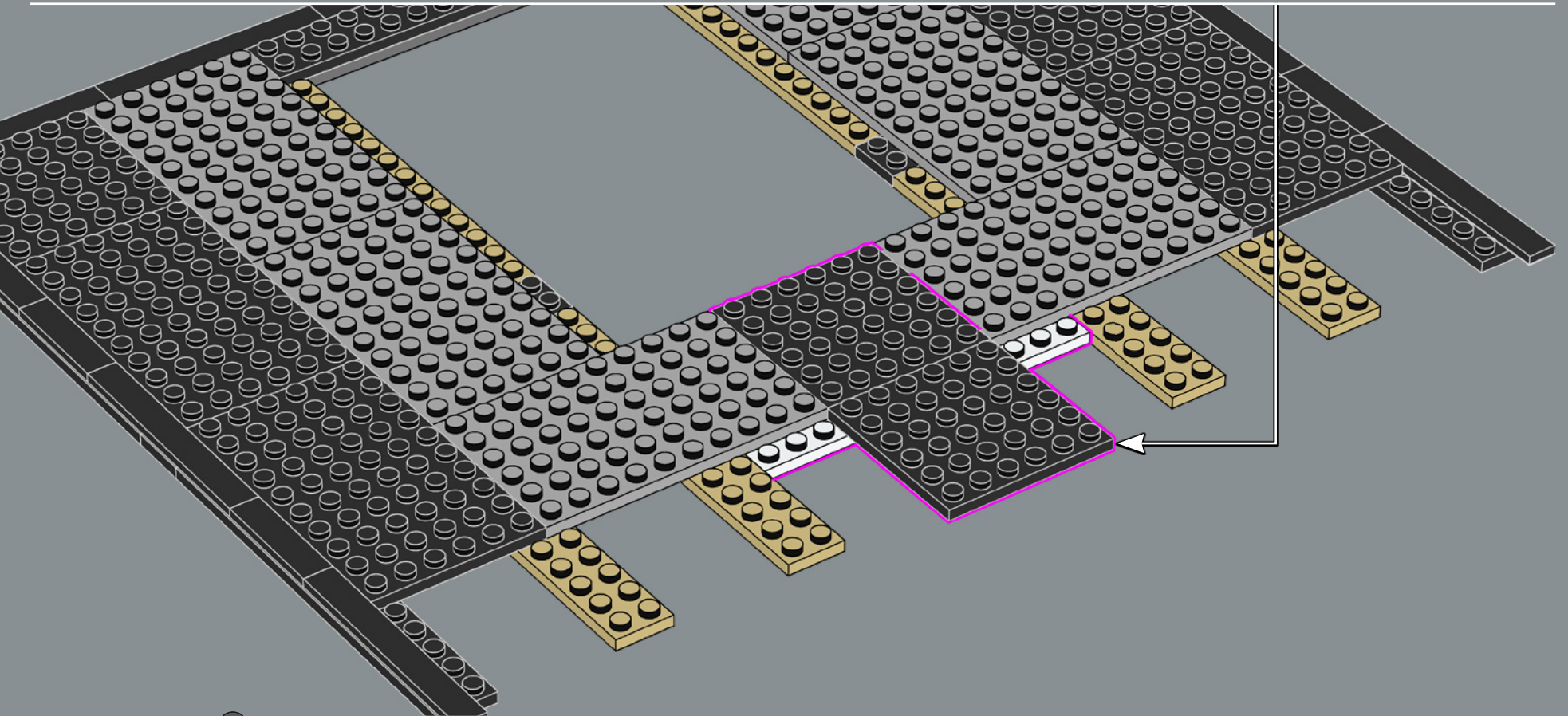

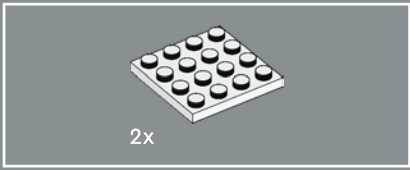

14

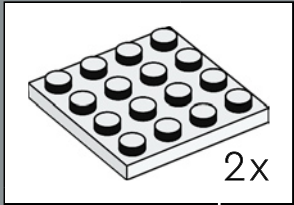
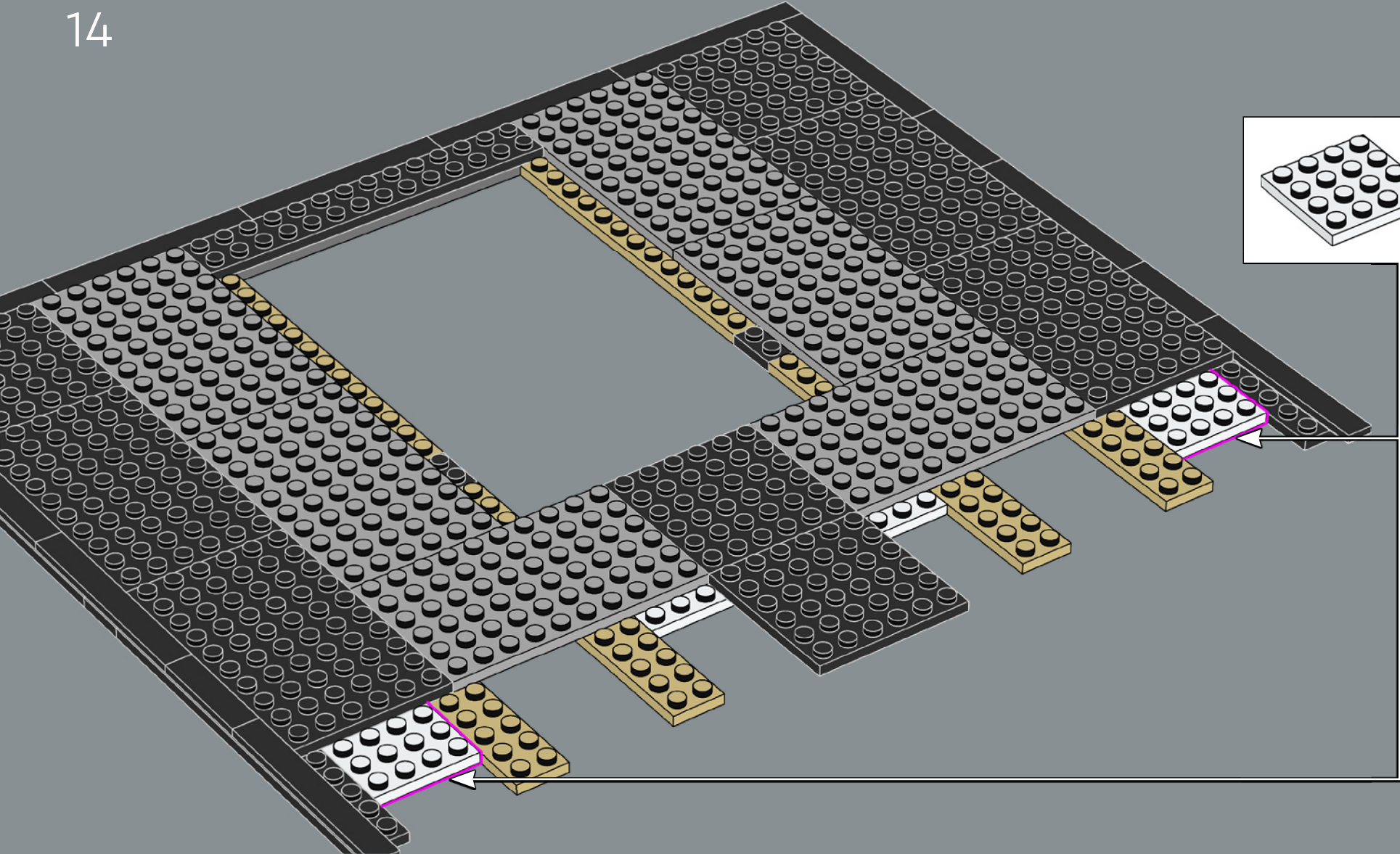

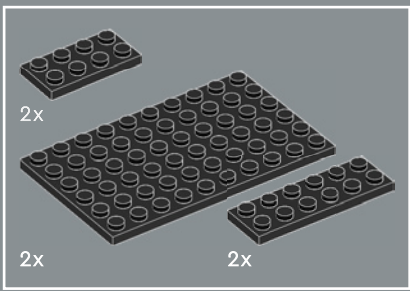

15

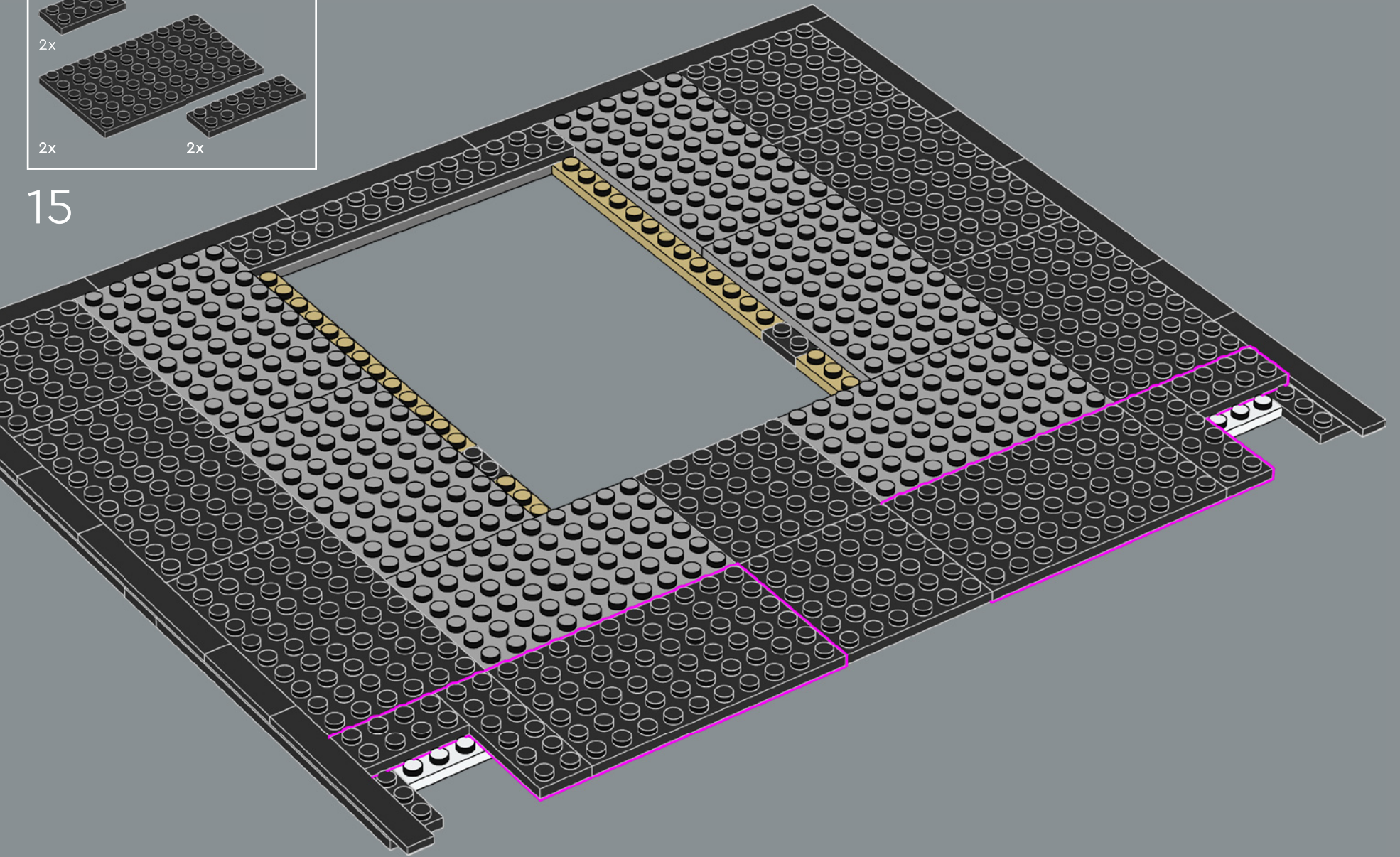

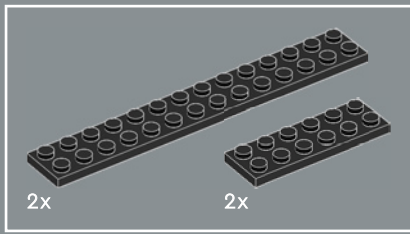

16

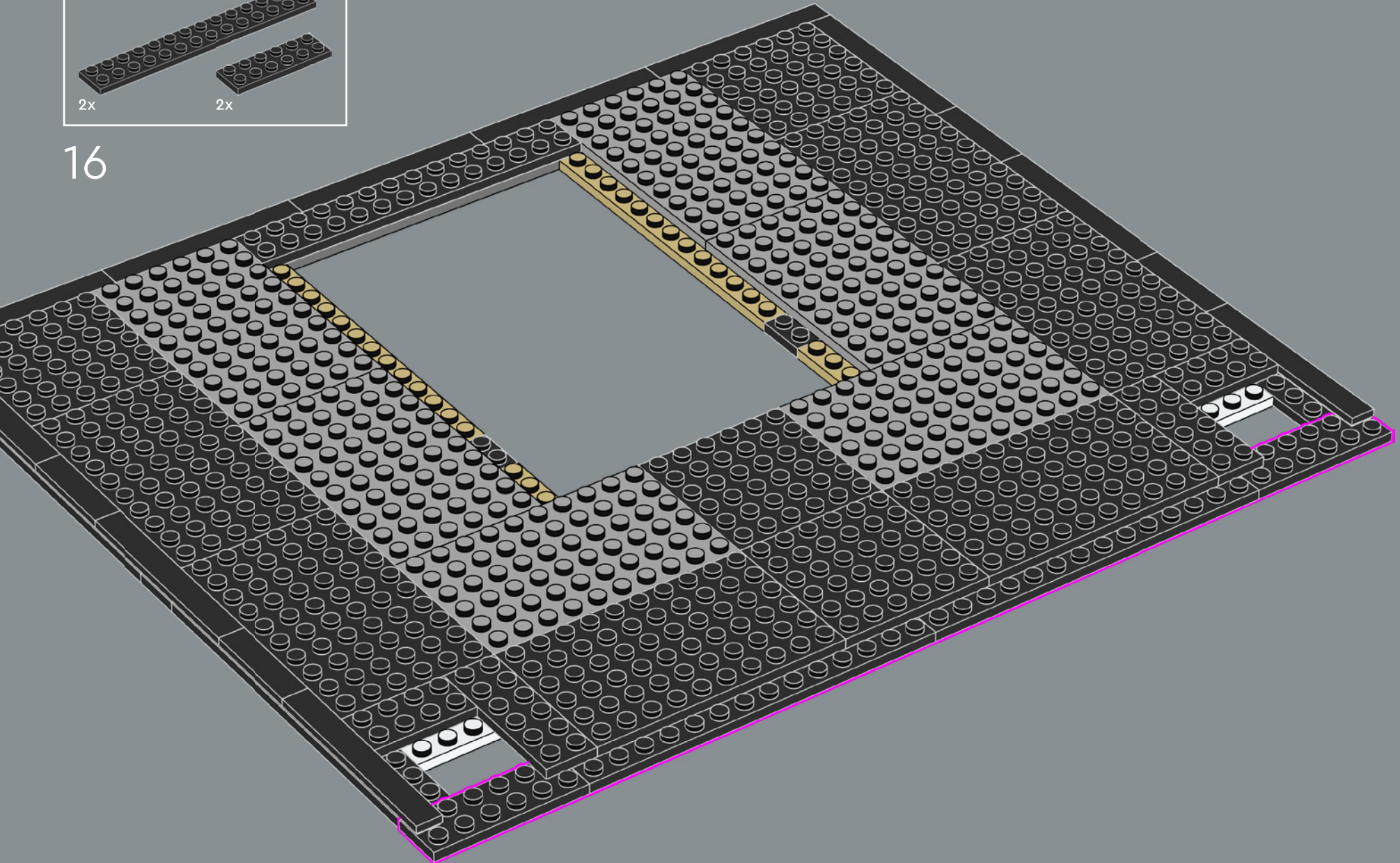

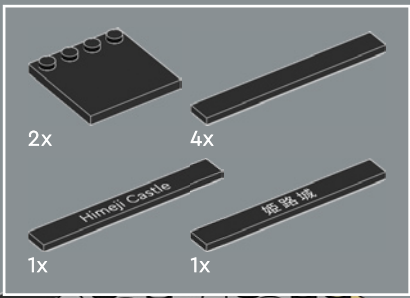

17

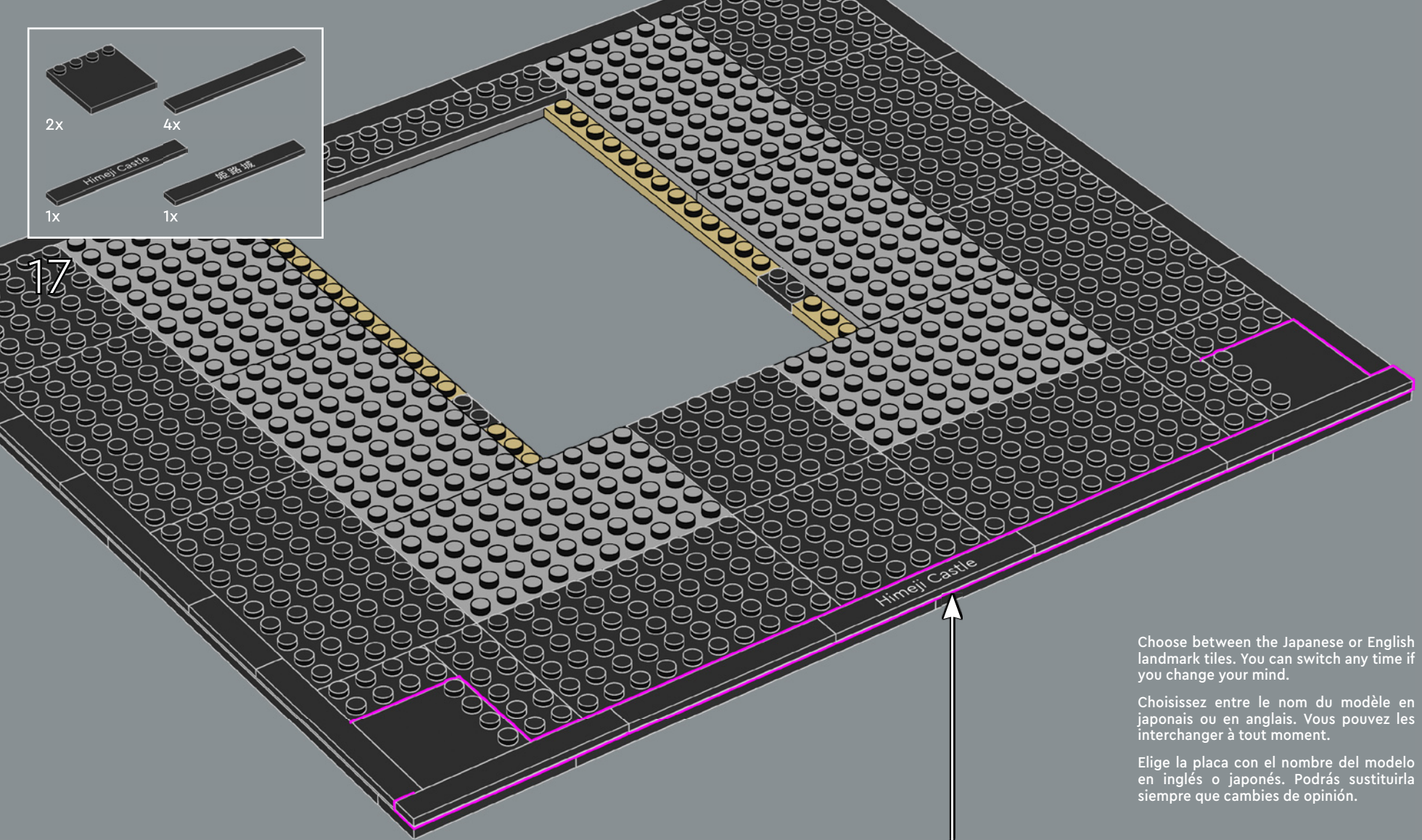

Choose between the Japanese or English landmark tiles. You can switch any time if you change your mind.

Choisissez entre le nom du modèle en japonais ou en anglais. Vous pouvez les interchanger à tout moment.

Elige la placa con el nombre del modelo en inglés o japonés. Podrás sustituirla siempre que cambies de opinión.



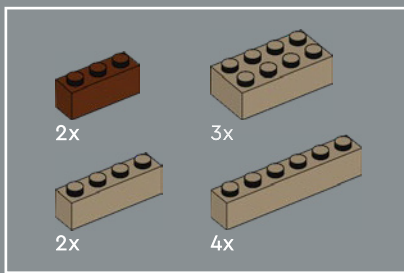

18

In 1993, Himeji Castle was inscribed on UNESCO's World Heritage list, honoring the landmark as a masterpiece and the culmination of Japanese castle architecture in wood.

En 1993, le château de Himeji a été inscrit sur la liste du patrimoine mondial de l'UNESCO, ce qui en fait un chef-d'œuvre et l'aboutissement de l'architecture des châteaux japonais en bois.

En 1993, el Castillo de Himeji fue inscrito en la Lista del Patrimonio Mundial de la UNESCO para rendir tributo al lugar como obra maestra y expresión suprema del estilo japonés de construcción de castillos con madera.

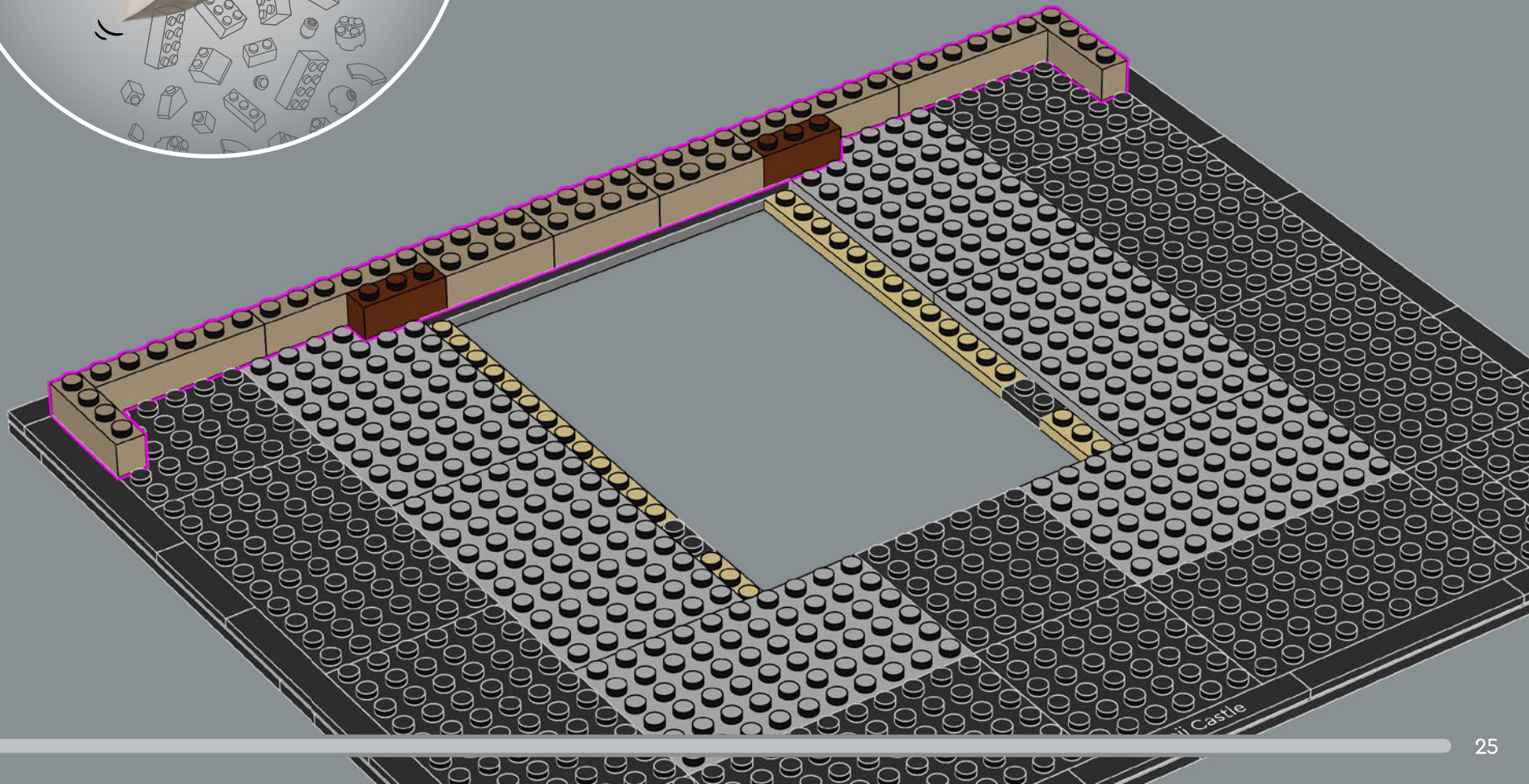

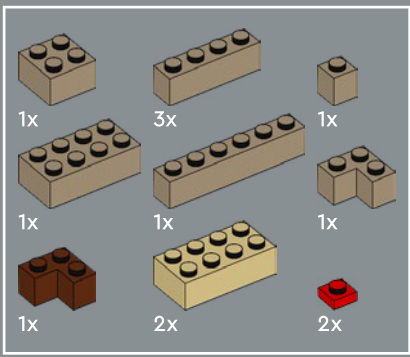

19

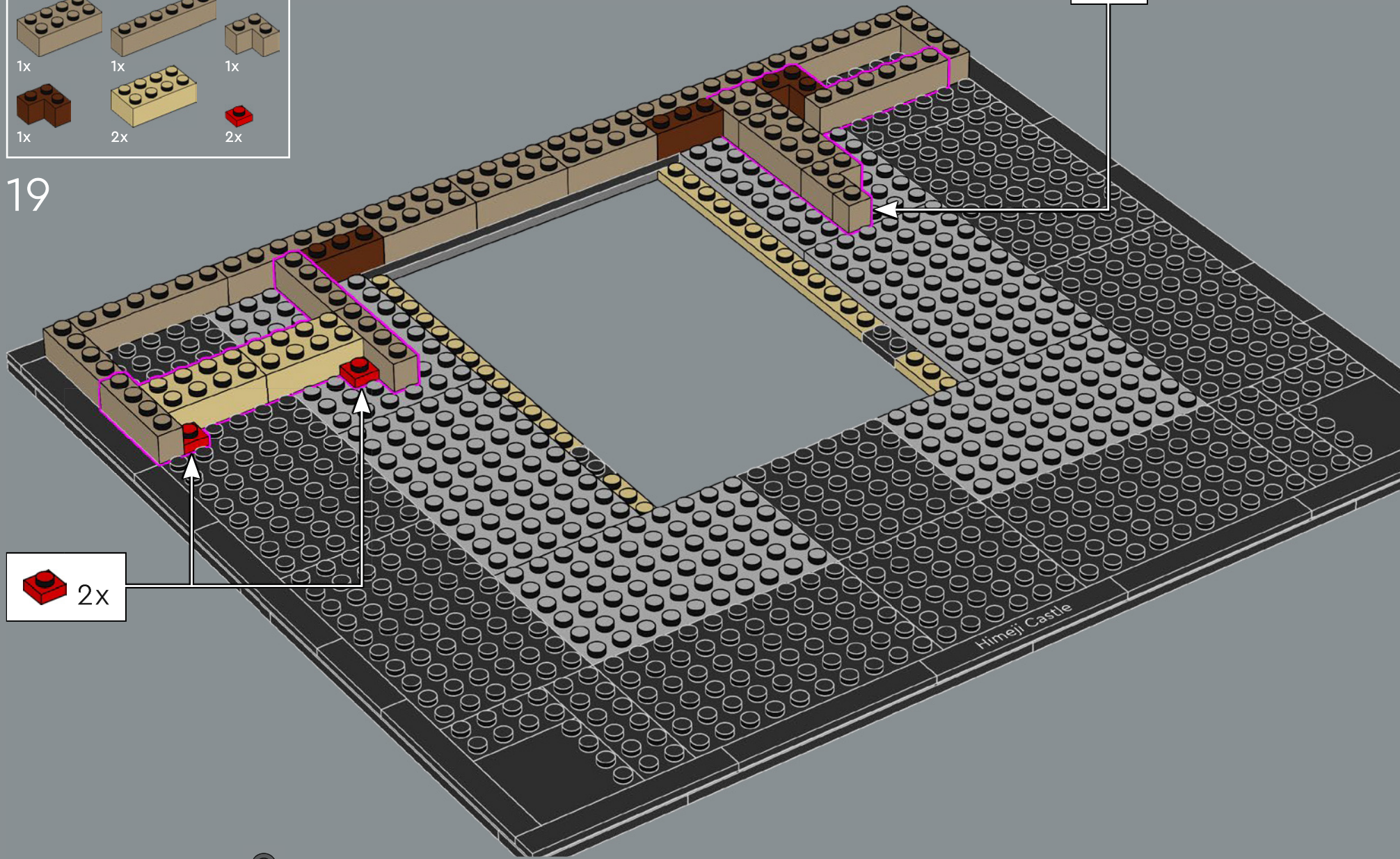

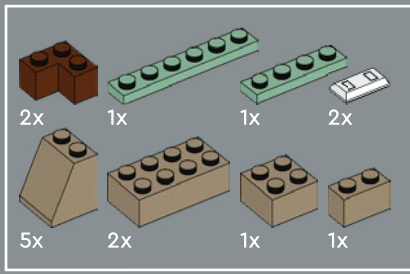

20

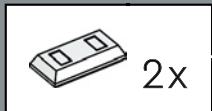
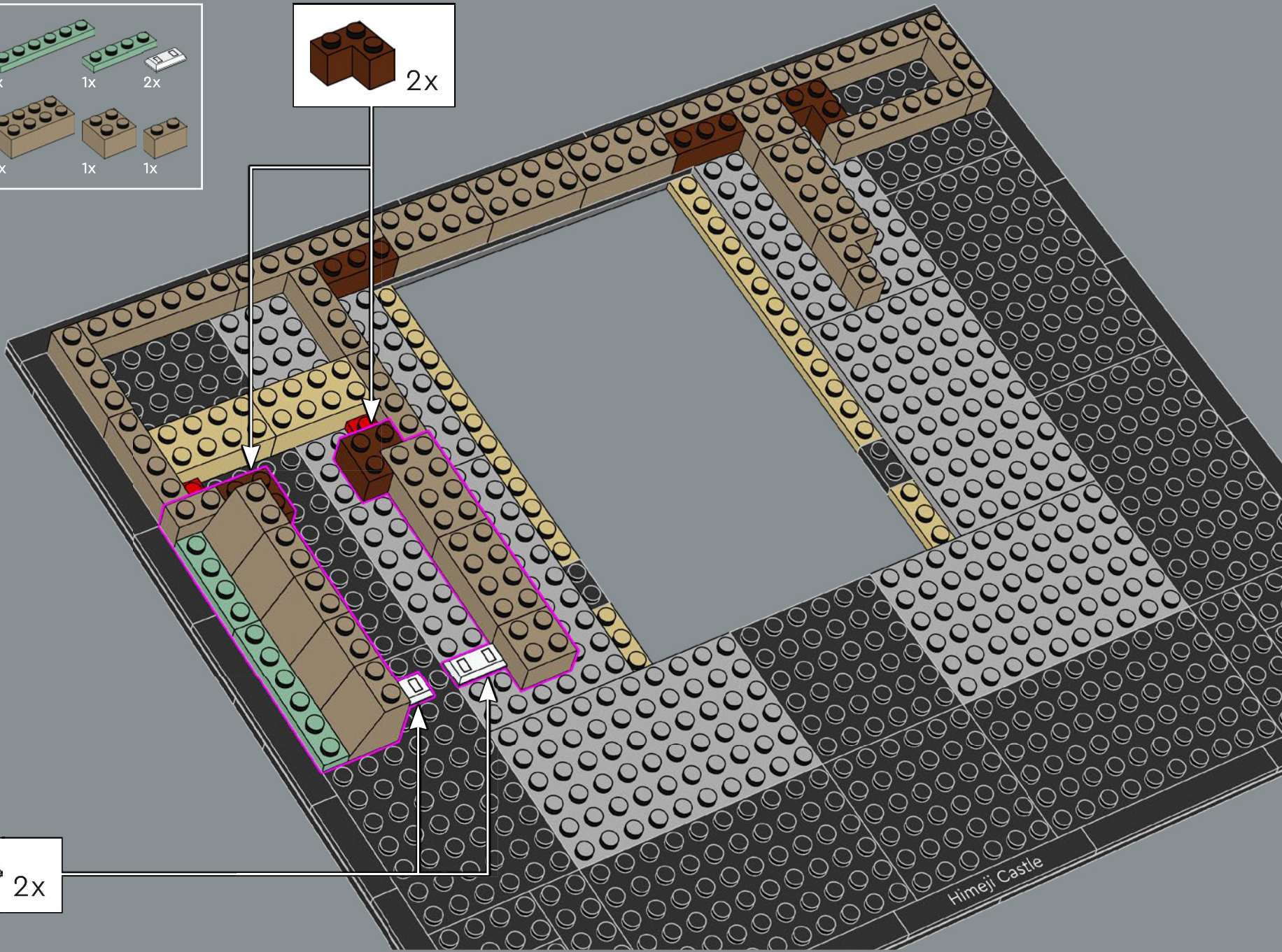

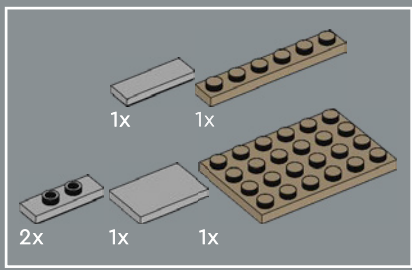



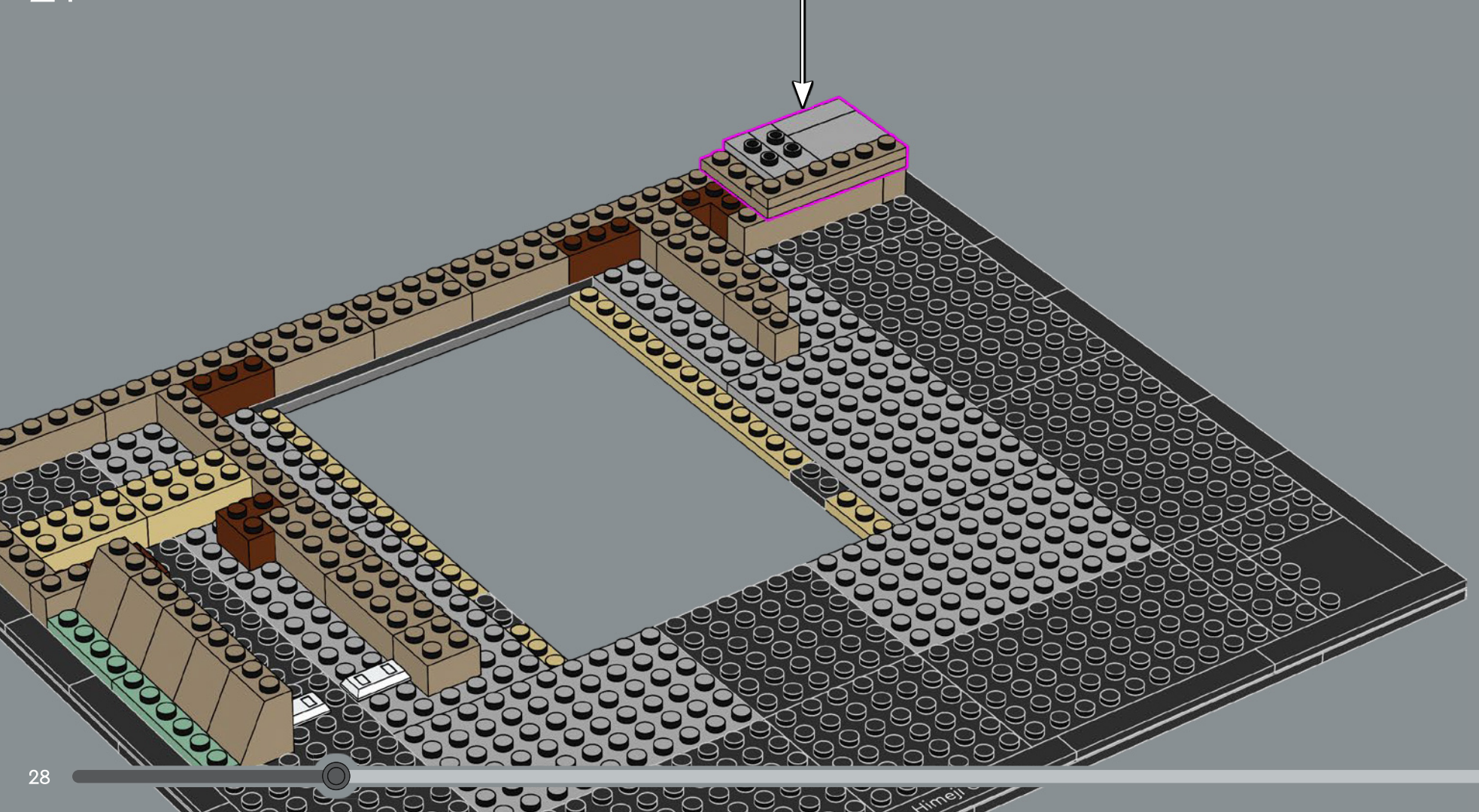
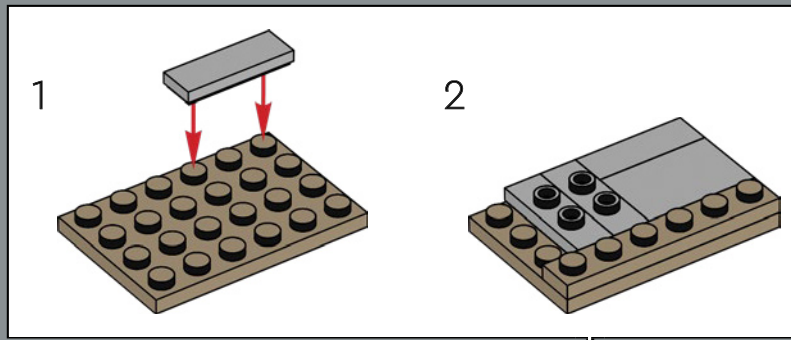

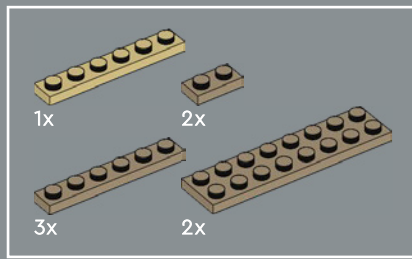

21

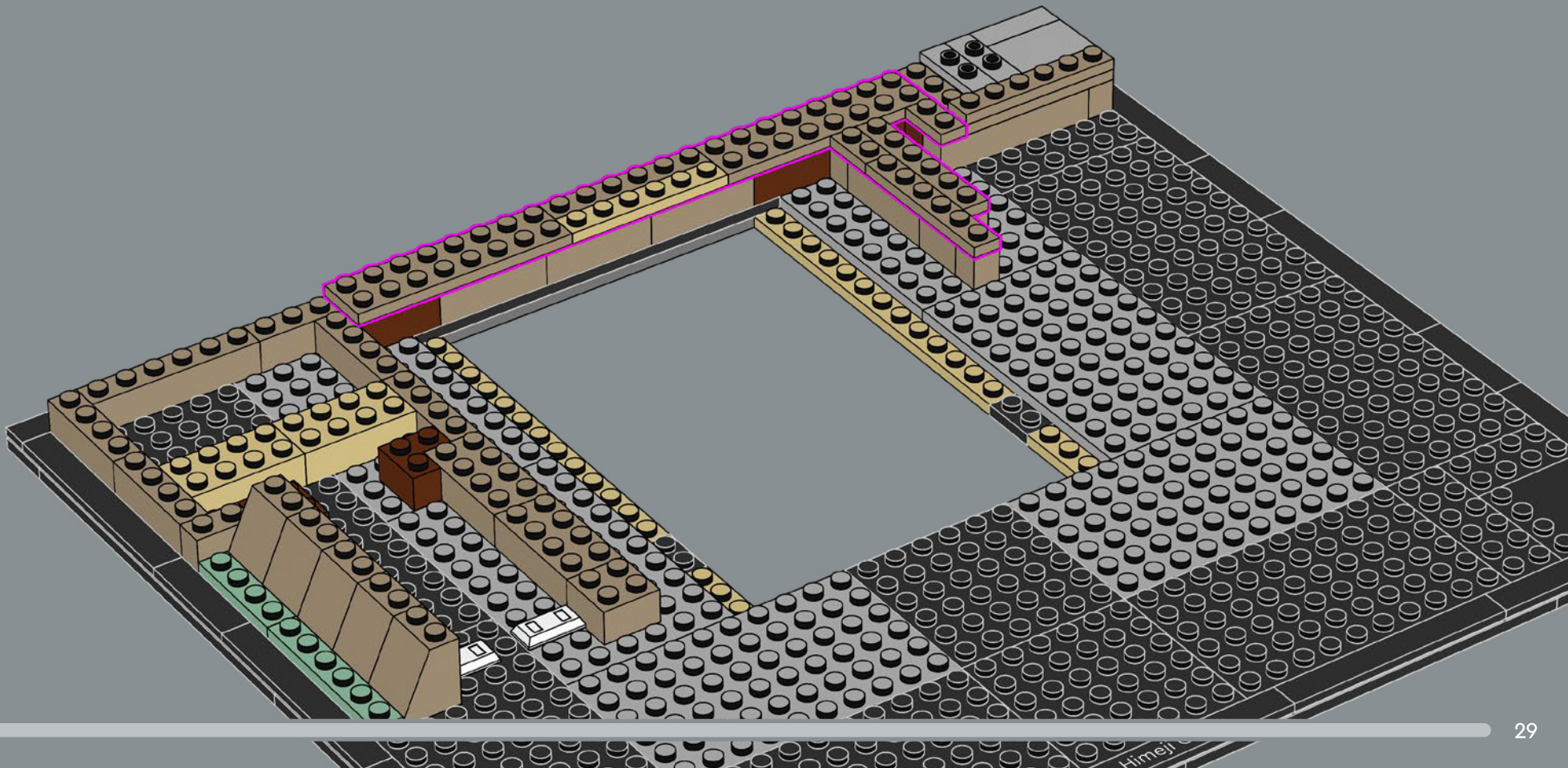



22



- 1x 
- 1x 
- 2x 
- 2x 
- 1x 

23

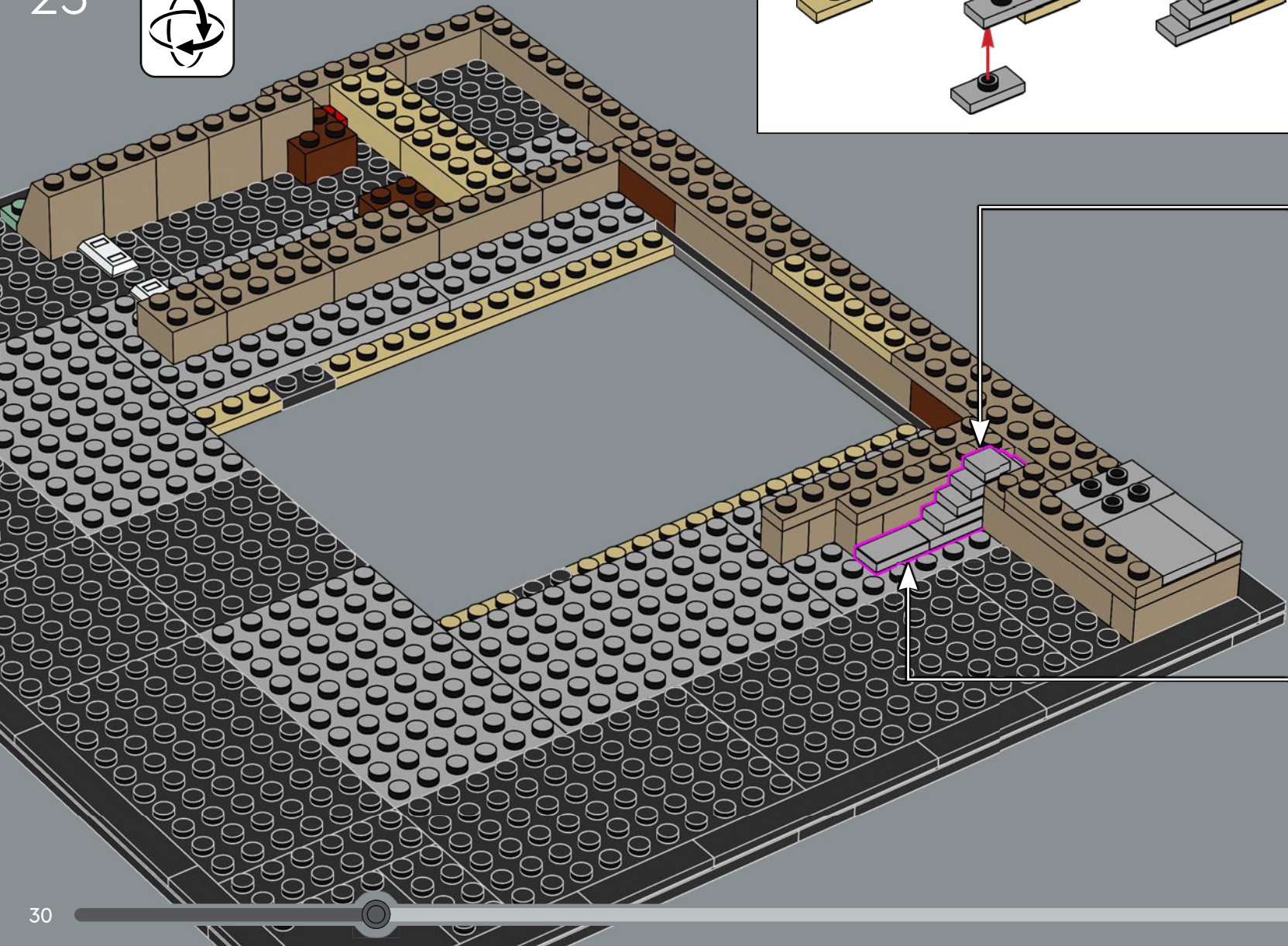
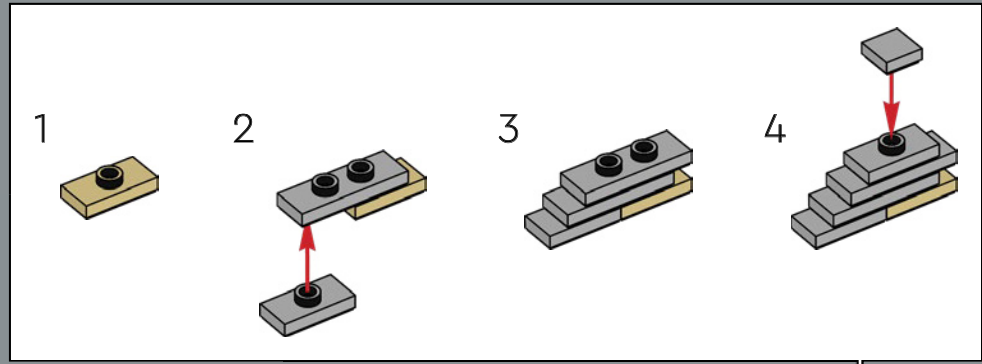

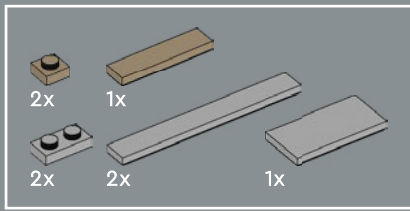

24

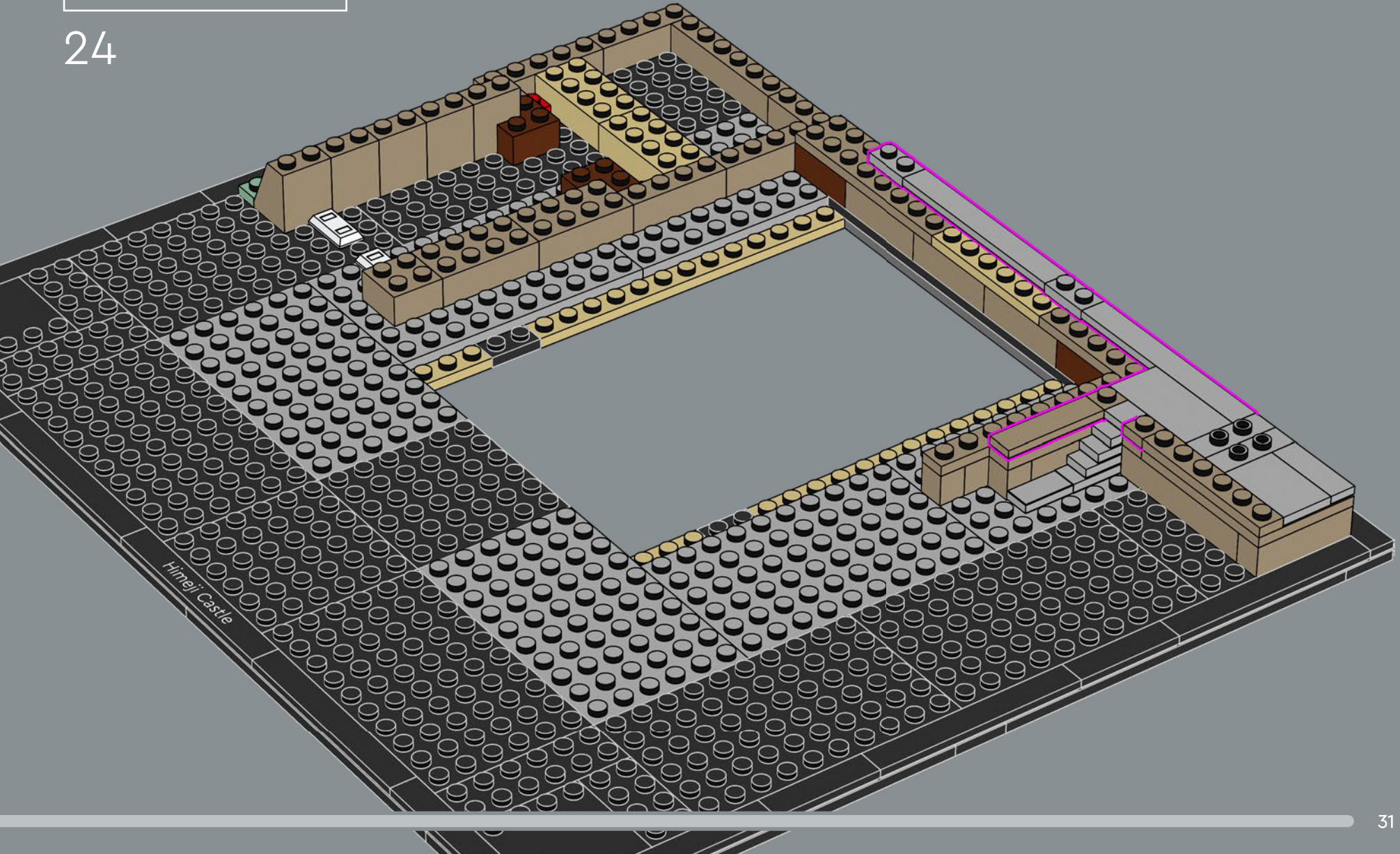

		
1x	4x	1x

25

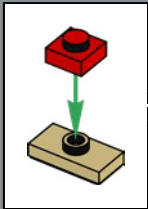
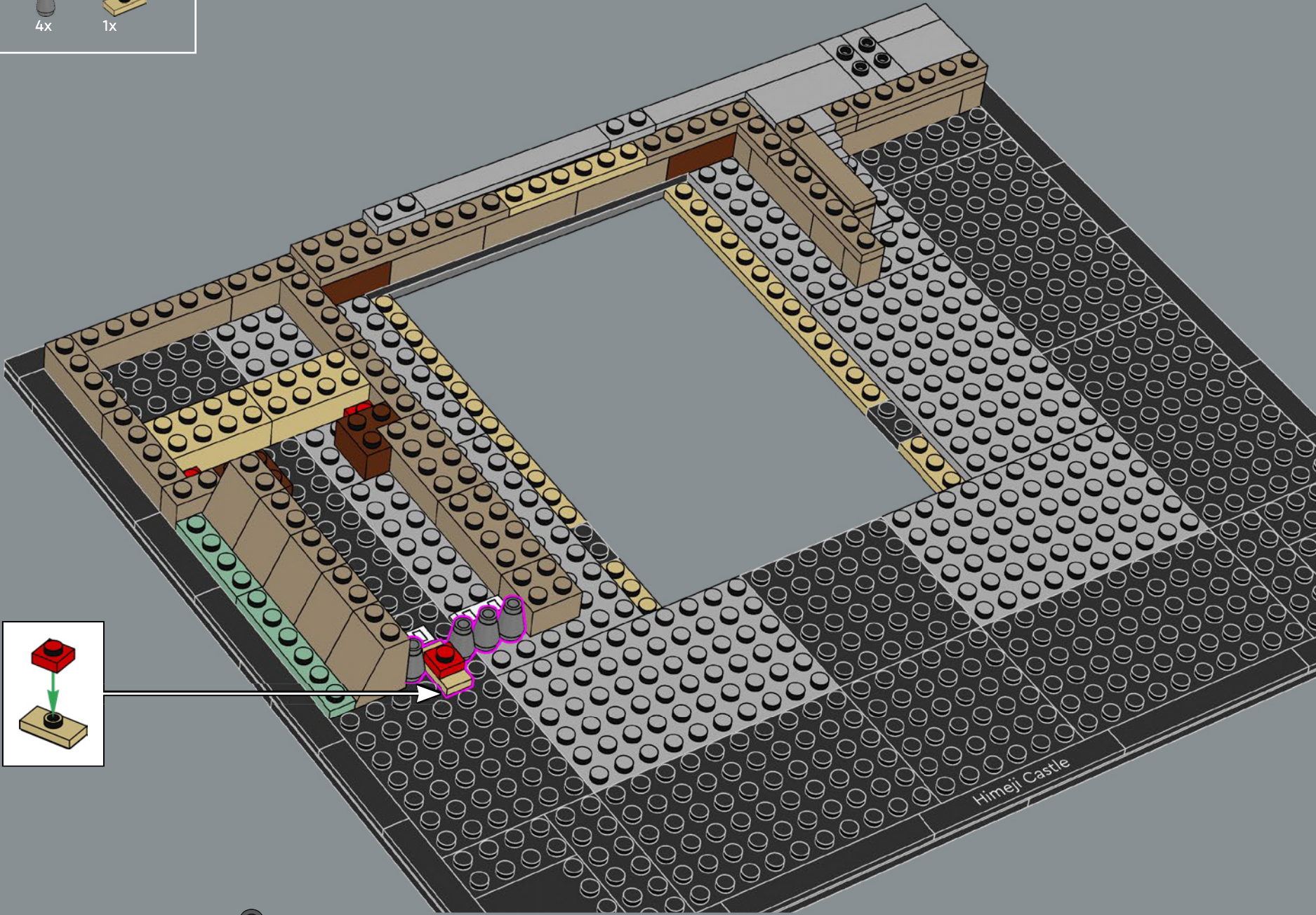

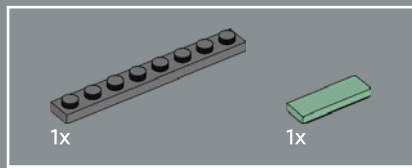

26

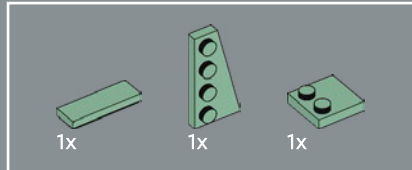
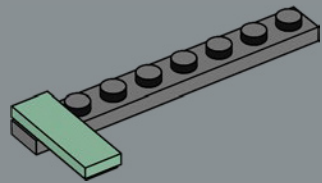

27

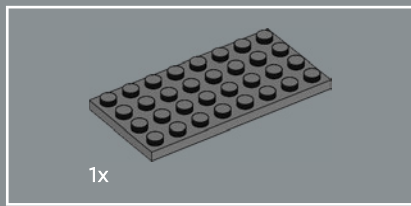
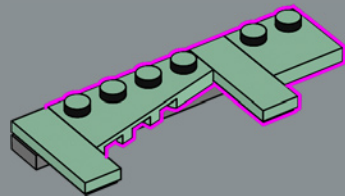

28

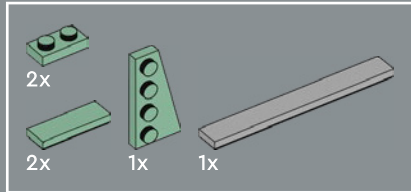
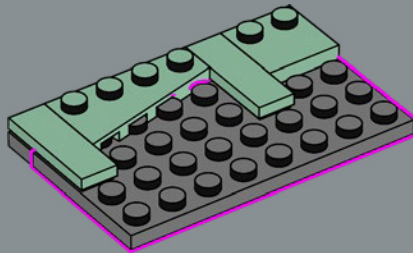

29

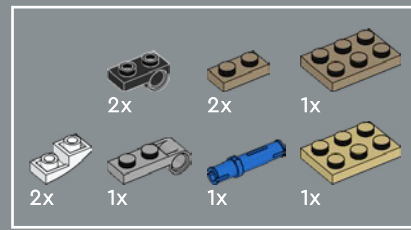
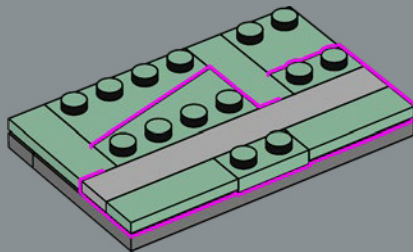

30

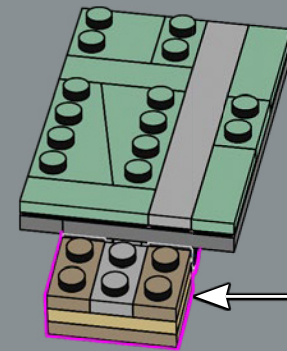
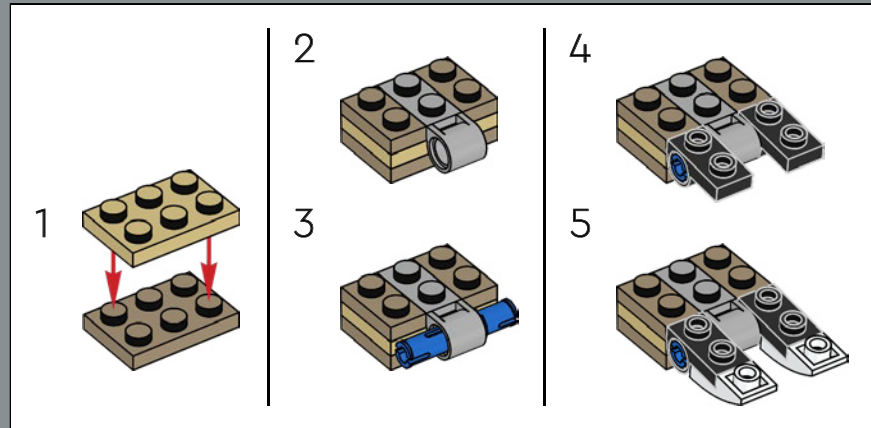

31

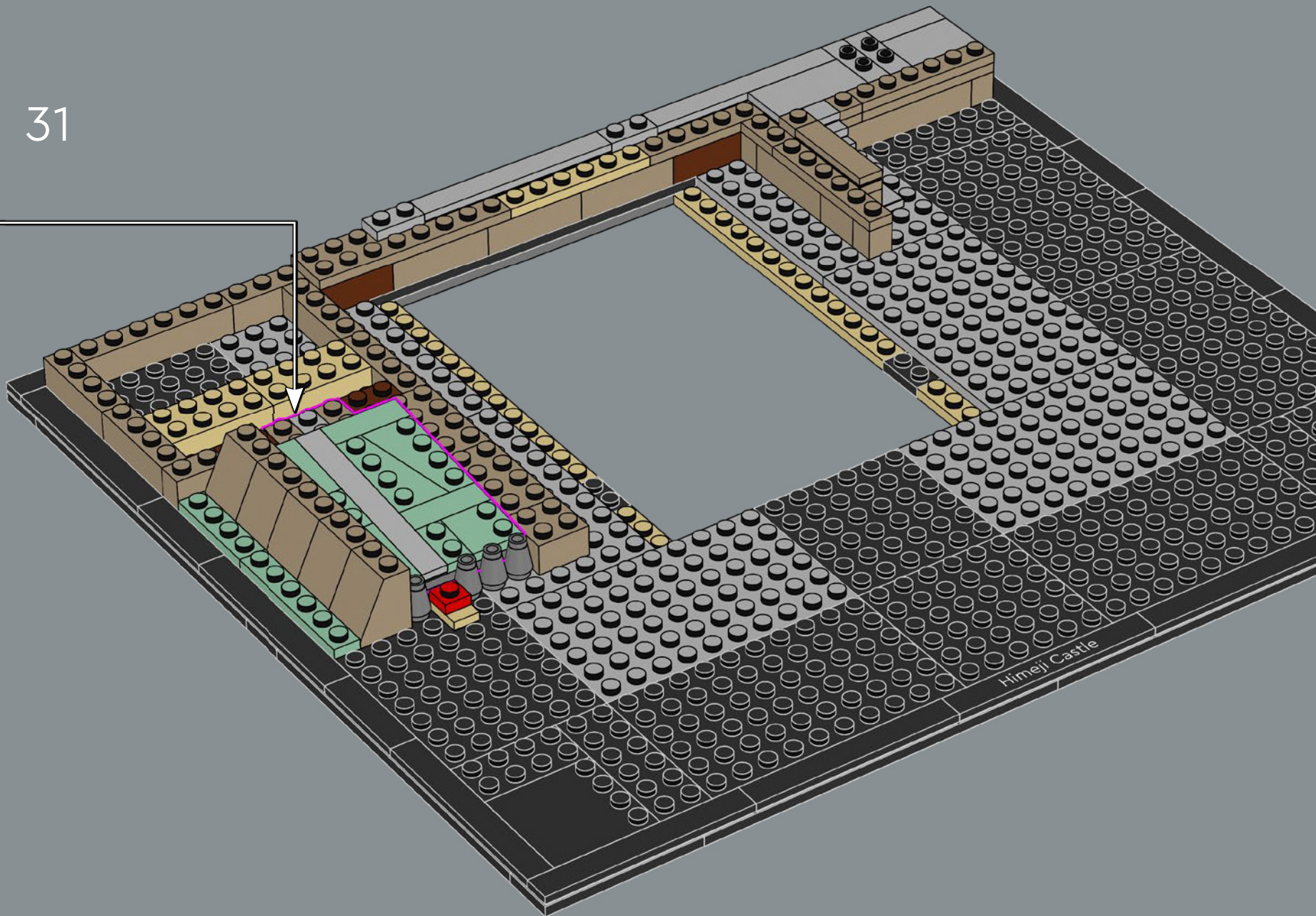

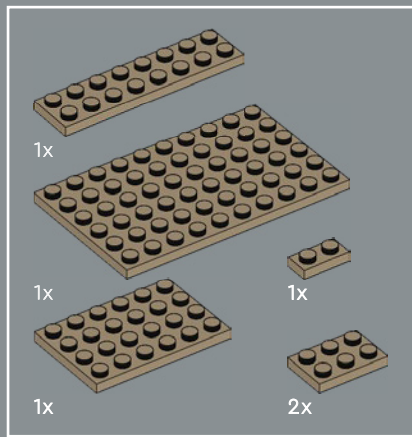

32

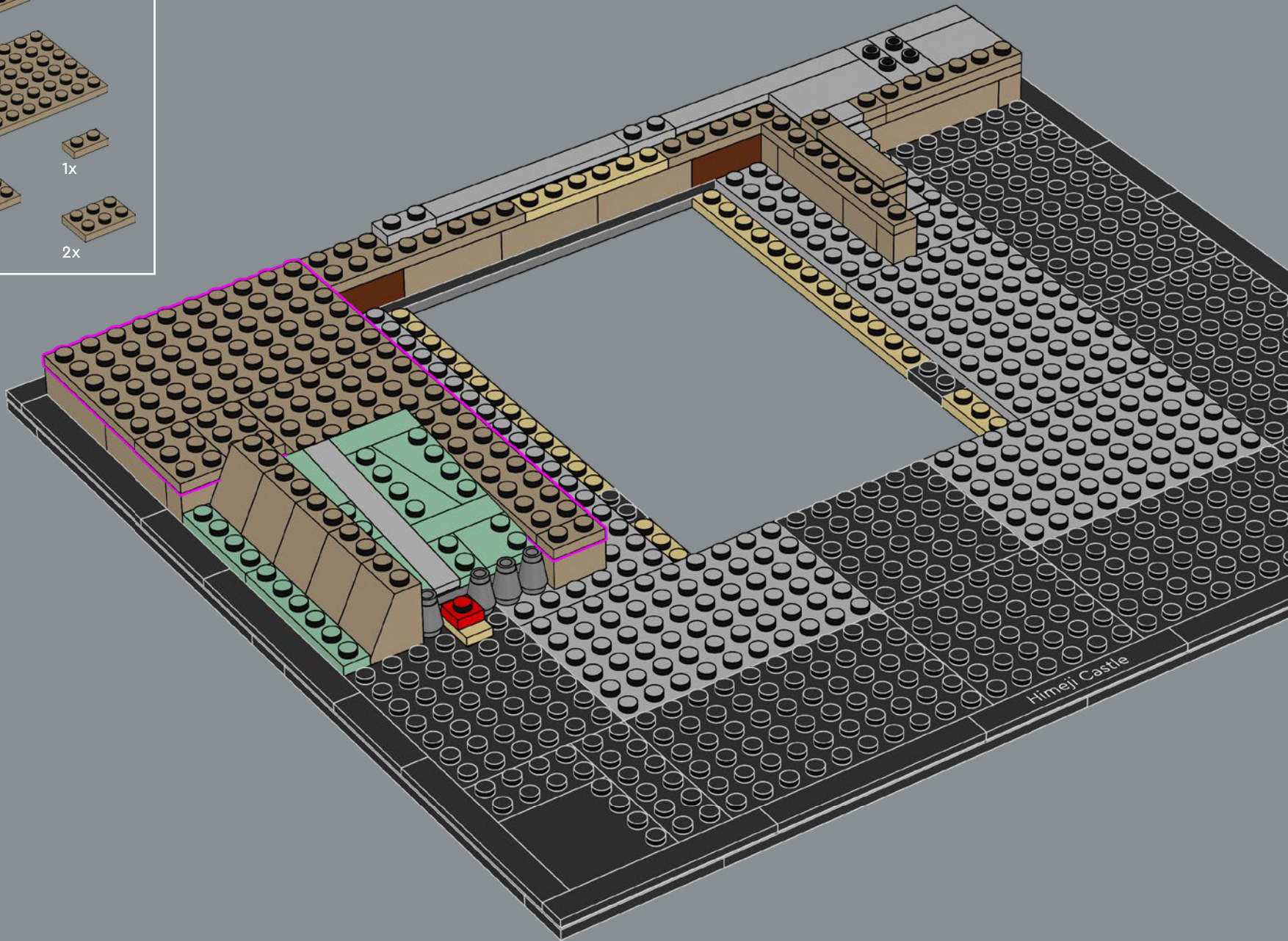

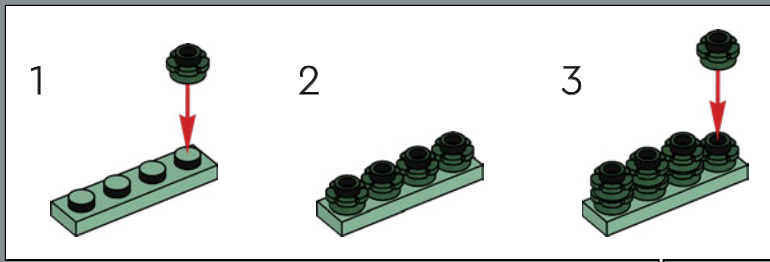
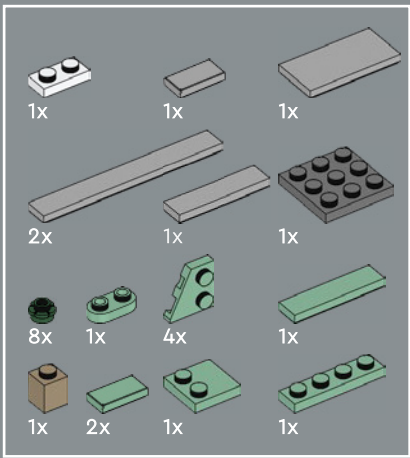

33

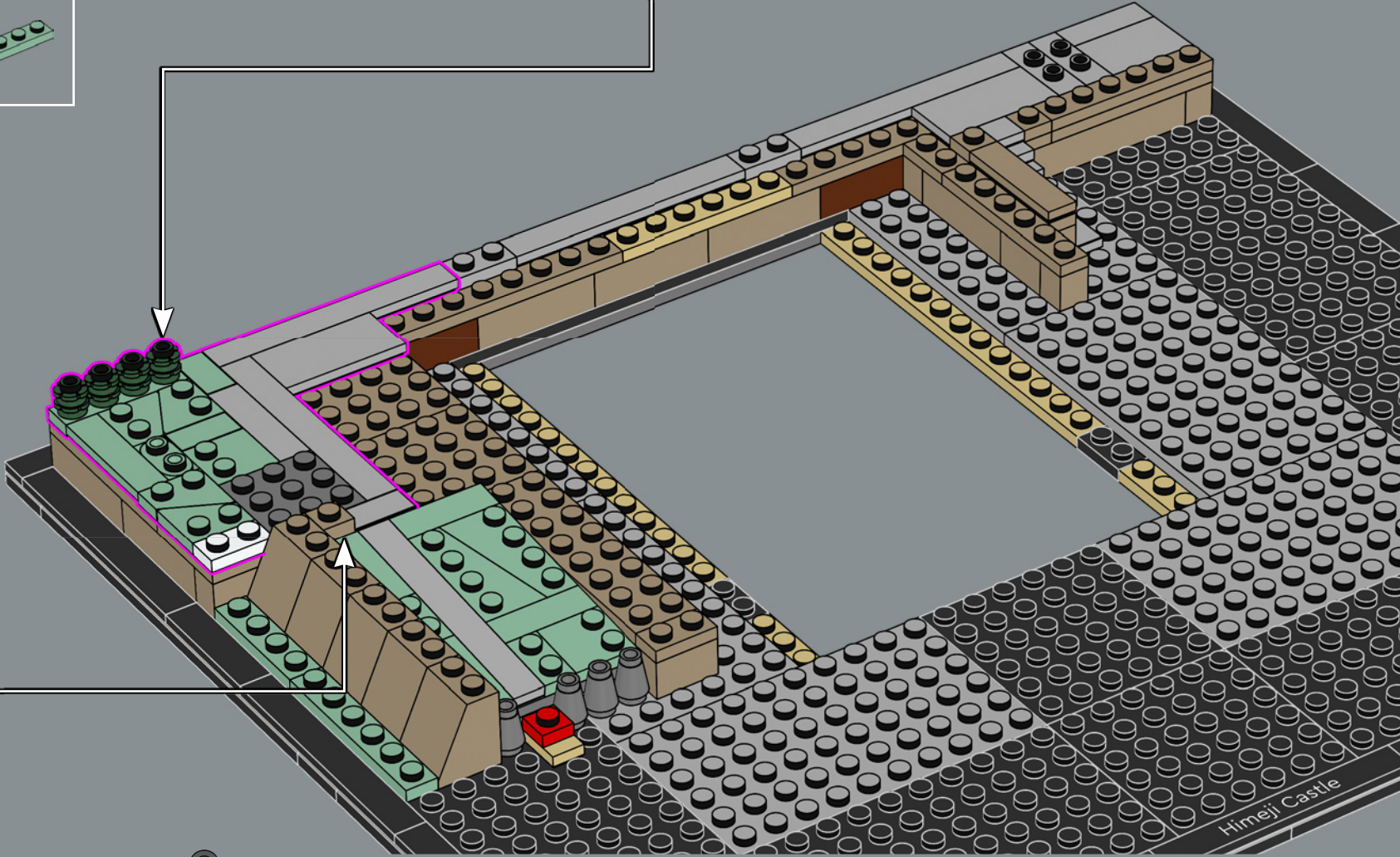

Himeiji Castle

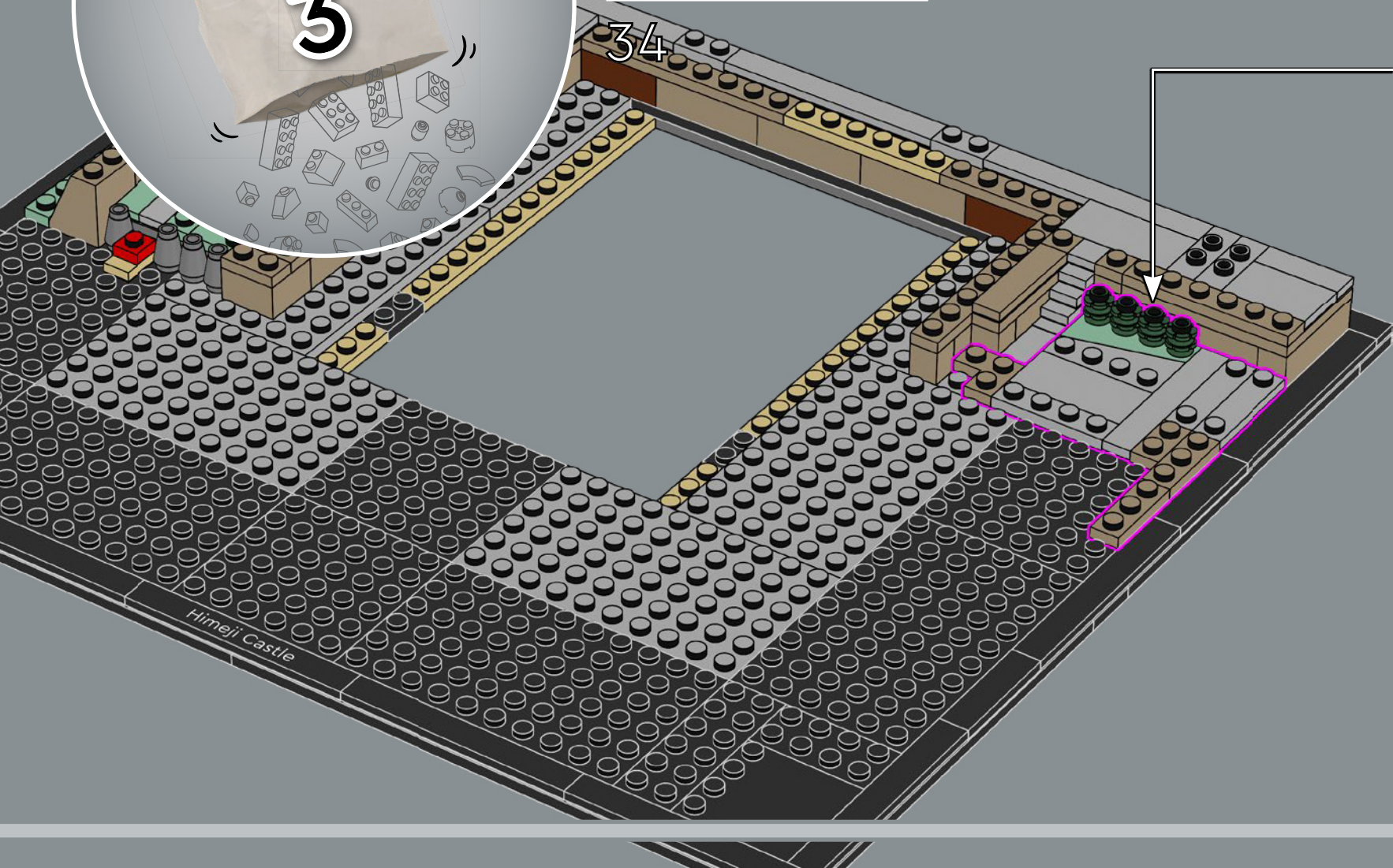
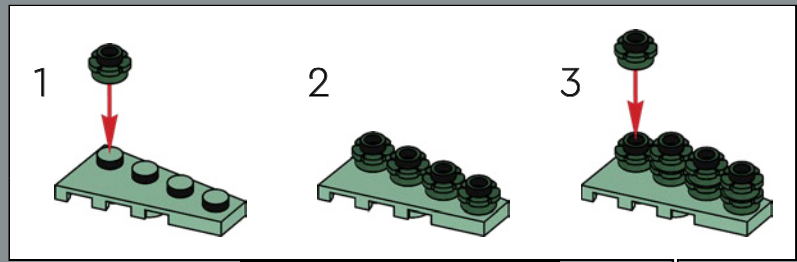
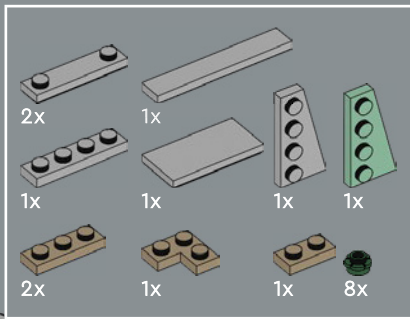

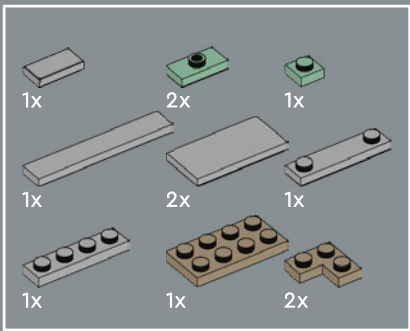

35

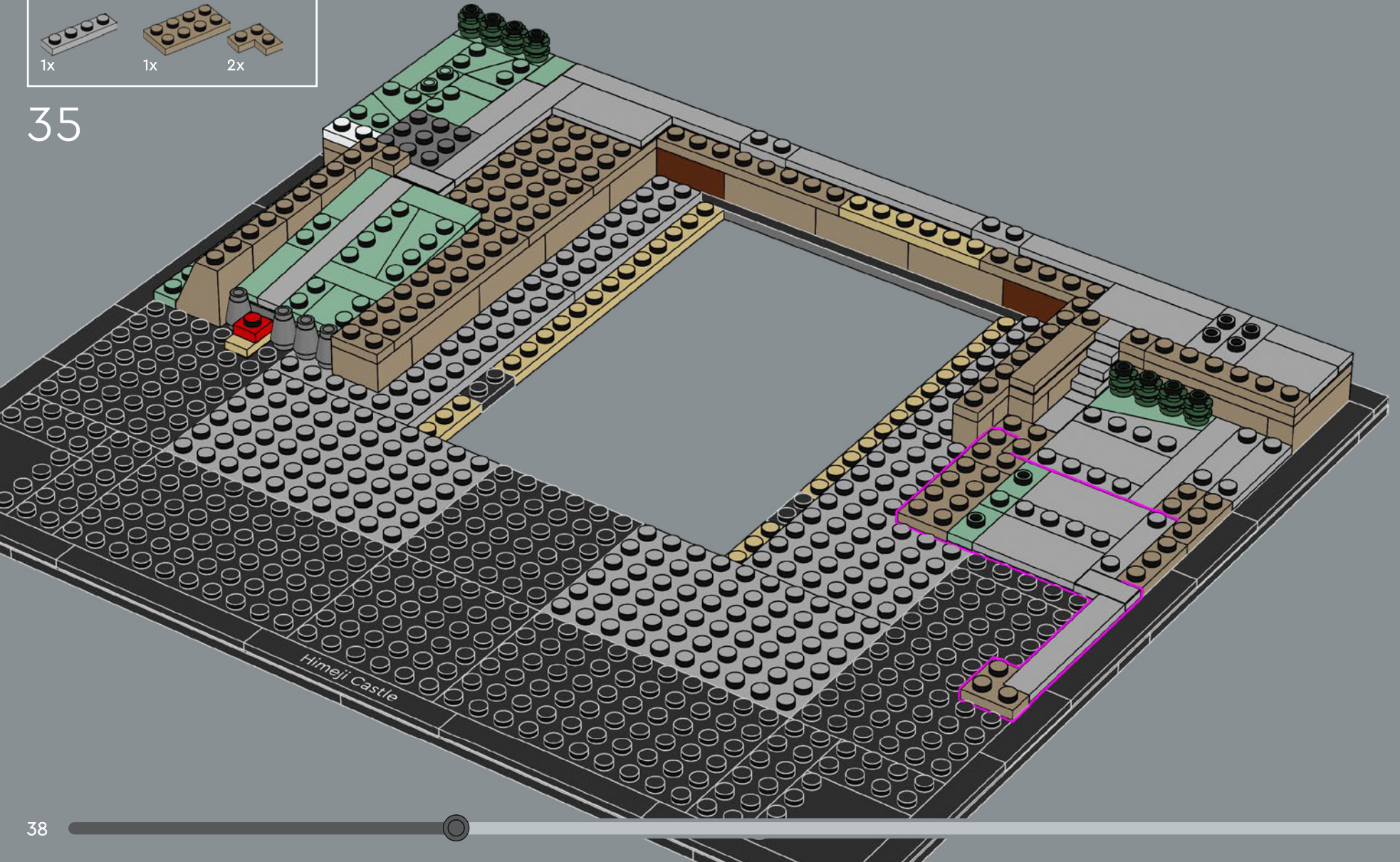

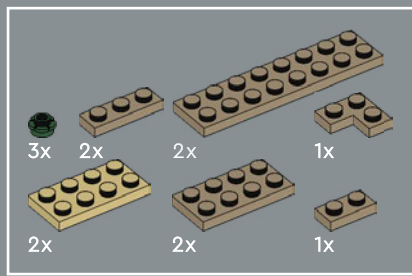

36

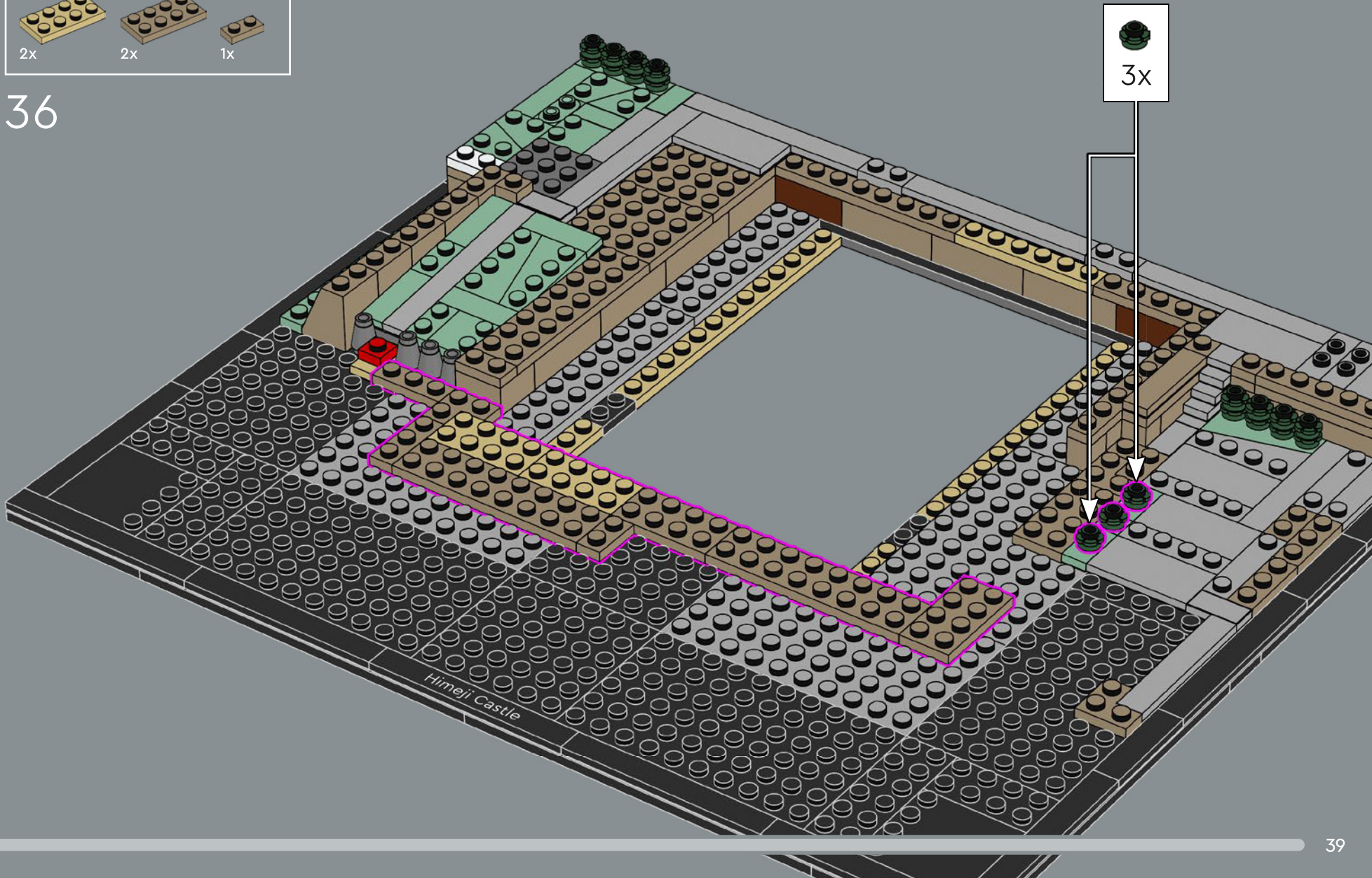

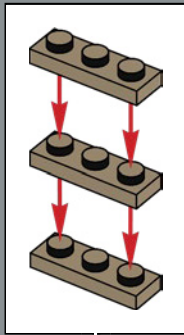
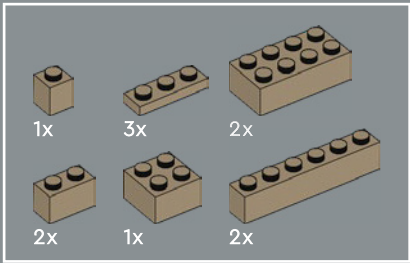

37

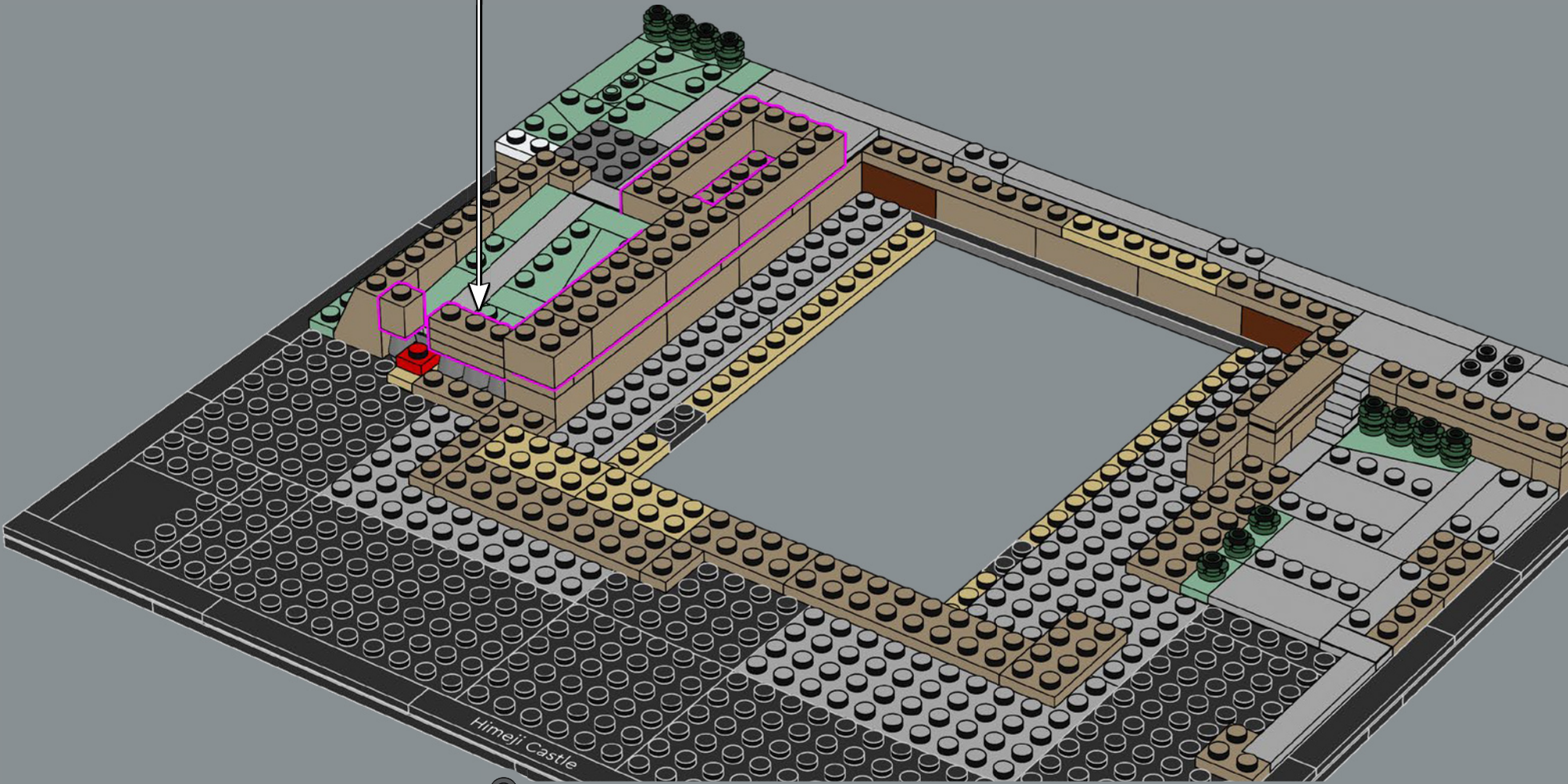

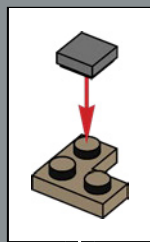
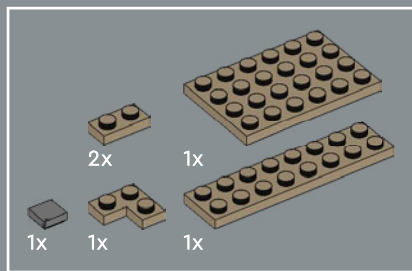

38

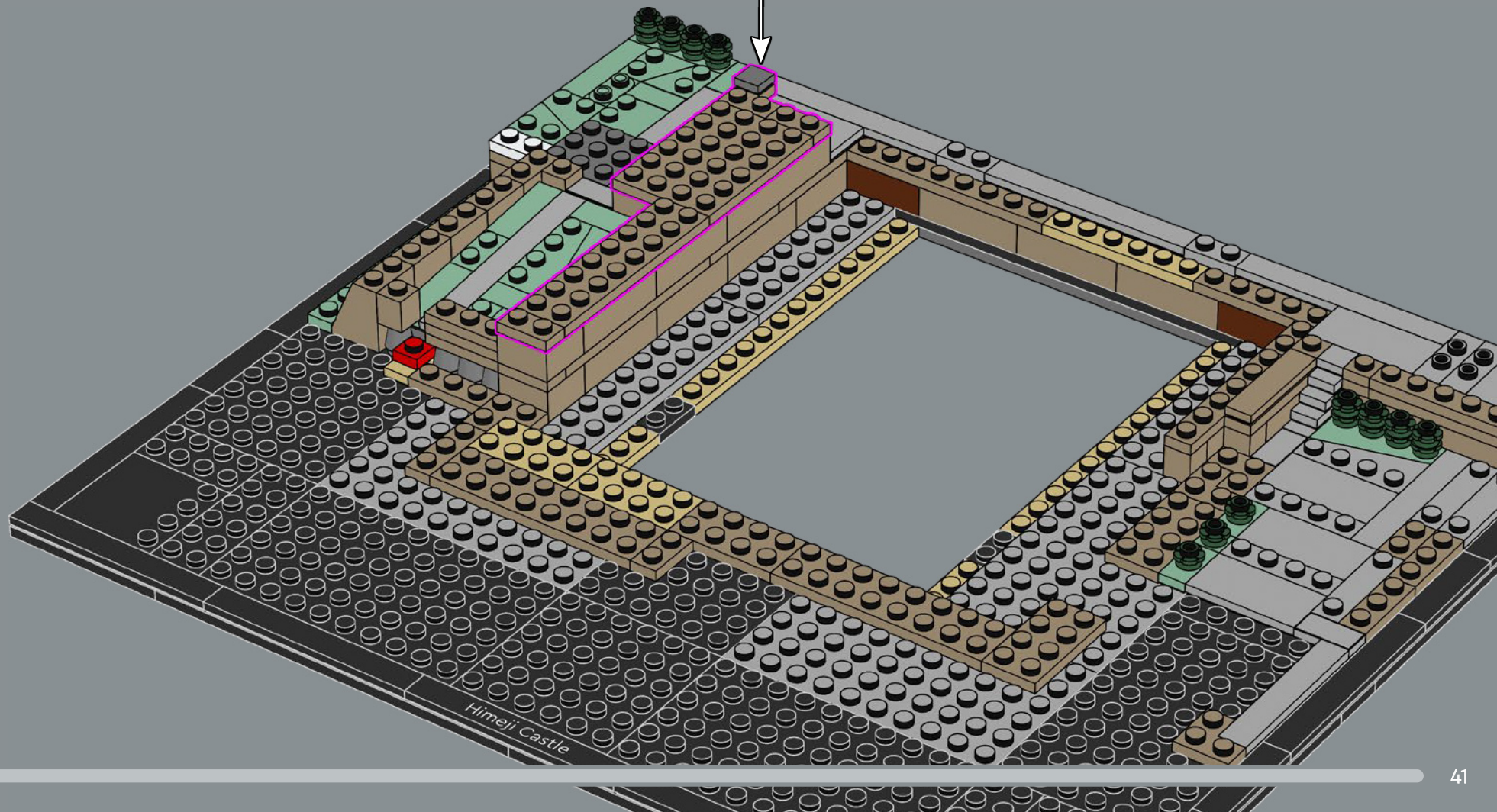

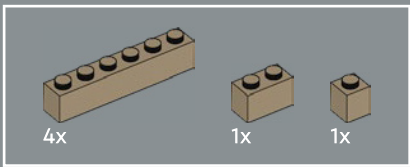

39

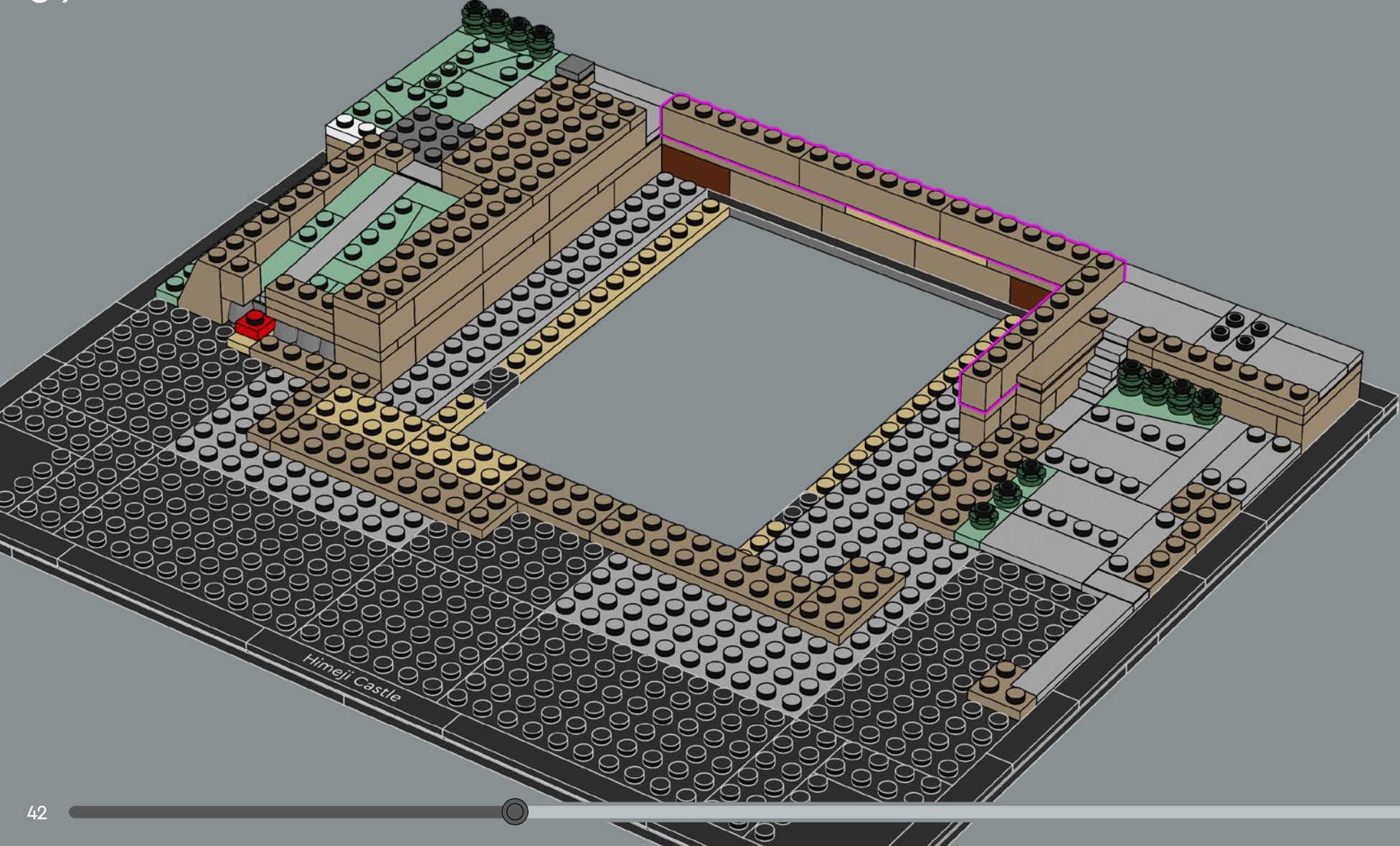

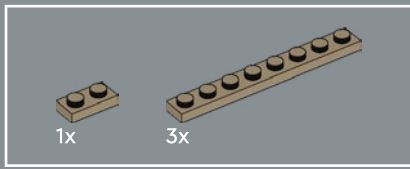

40

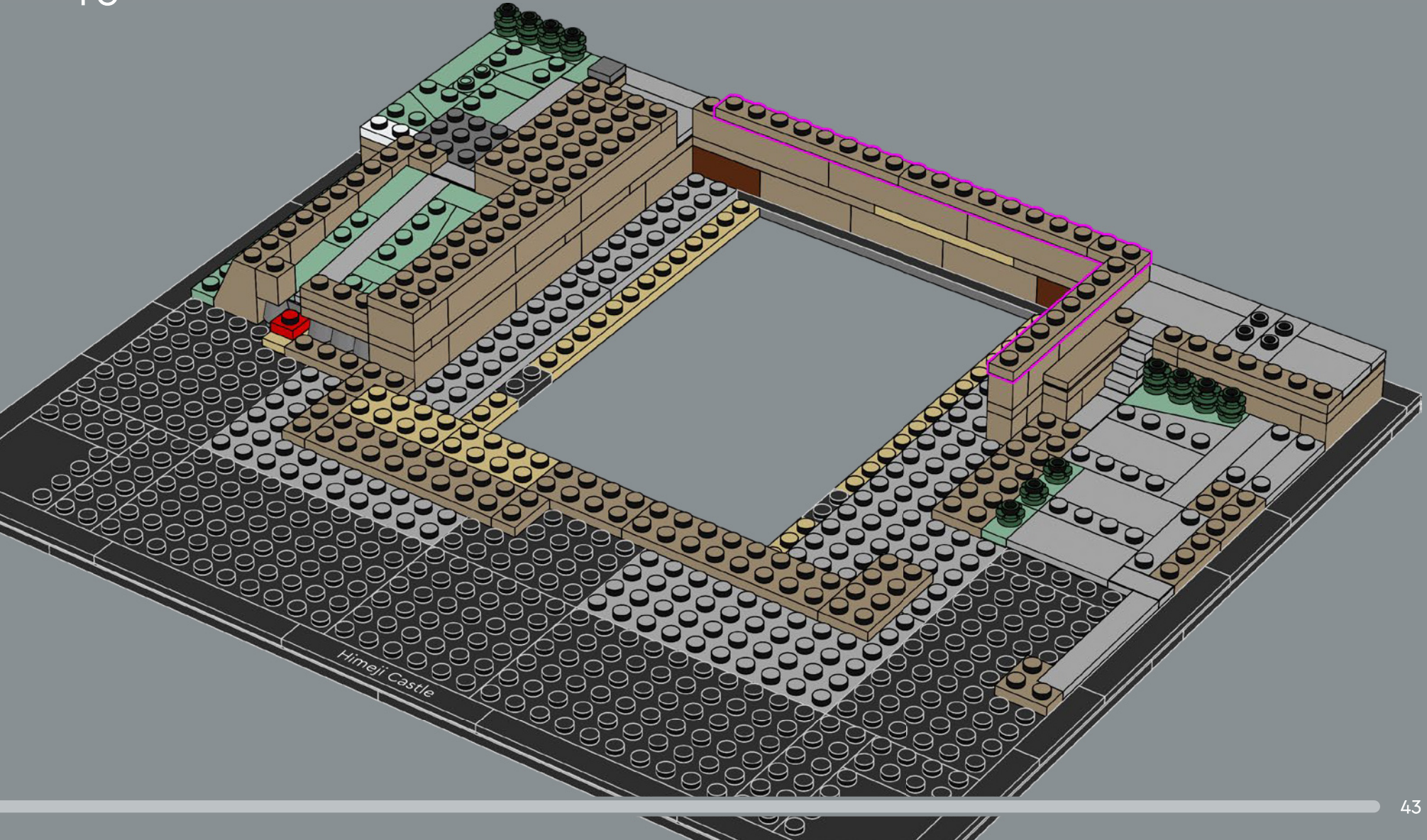

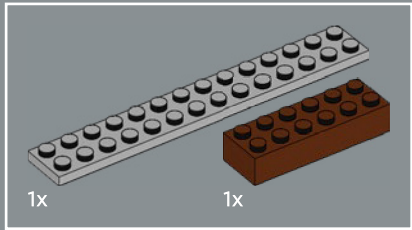
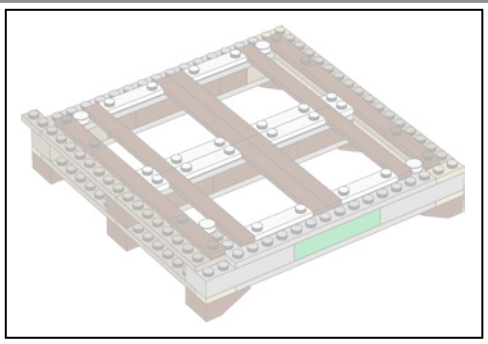

41

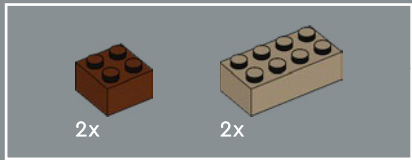
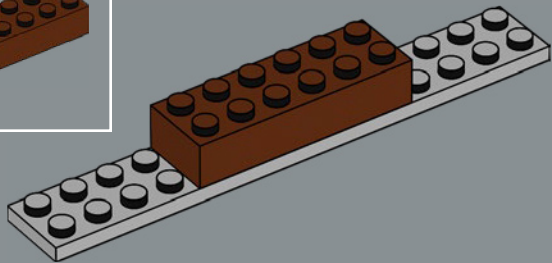

42

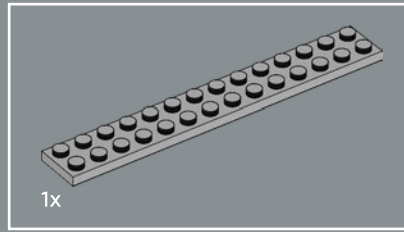
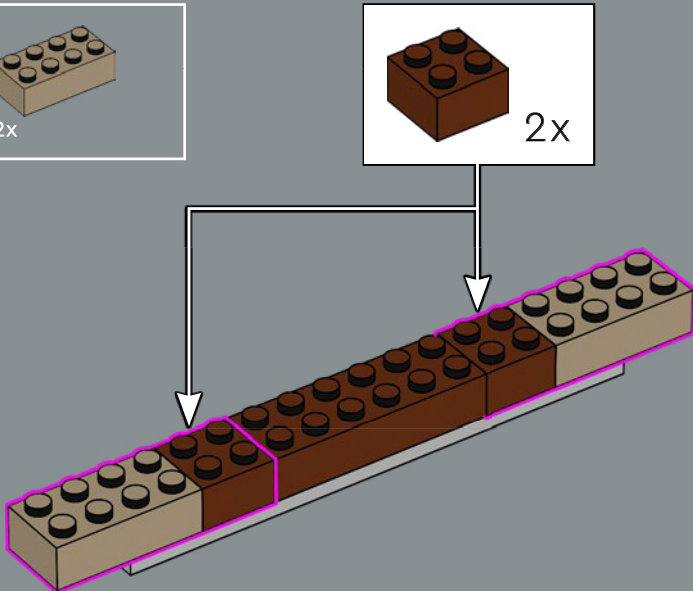

43

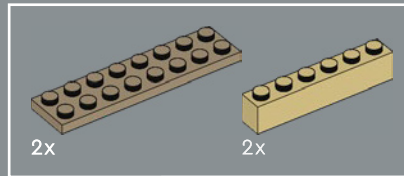
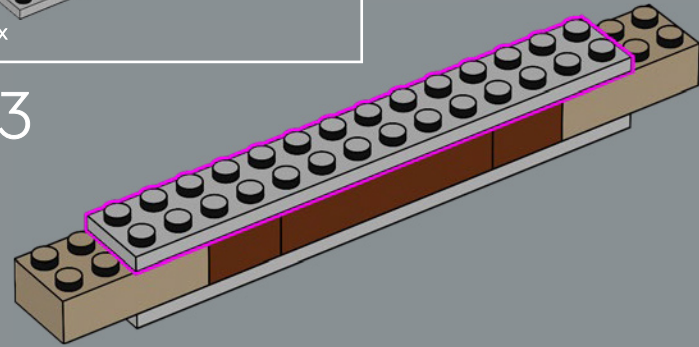

44

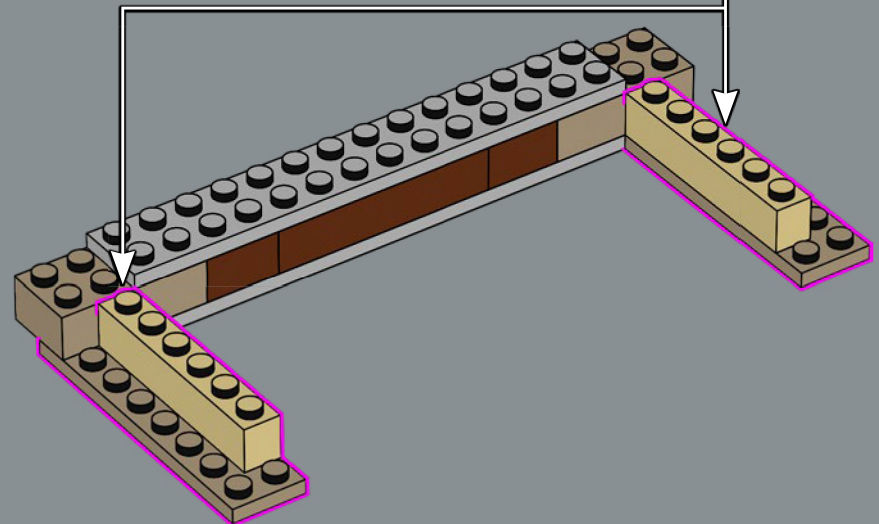
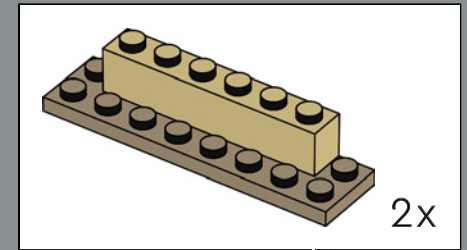

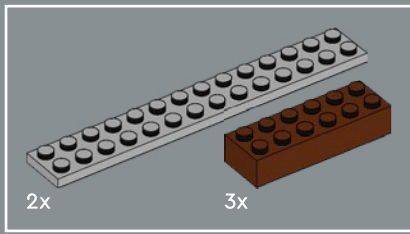

45

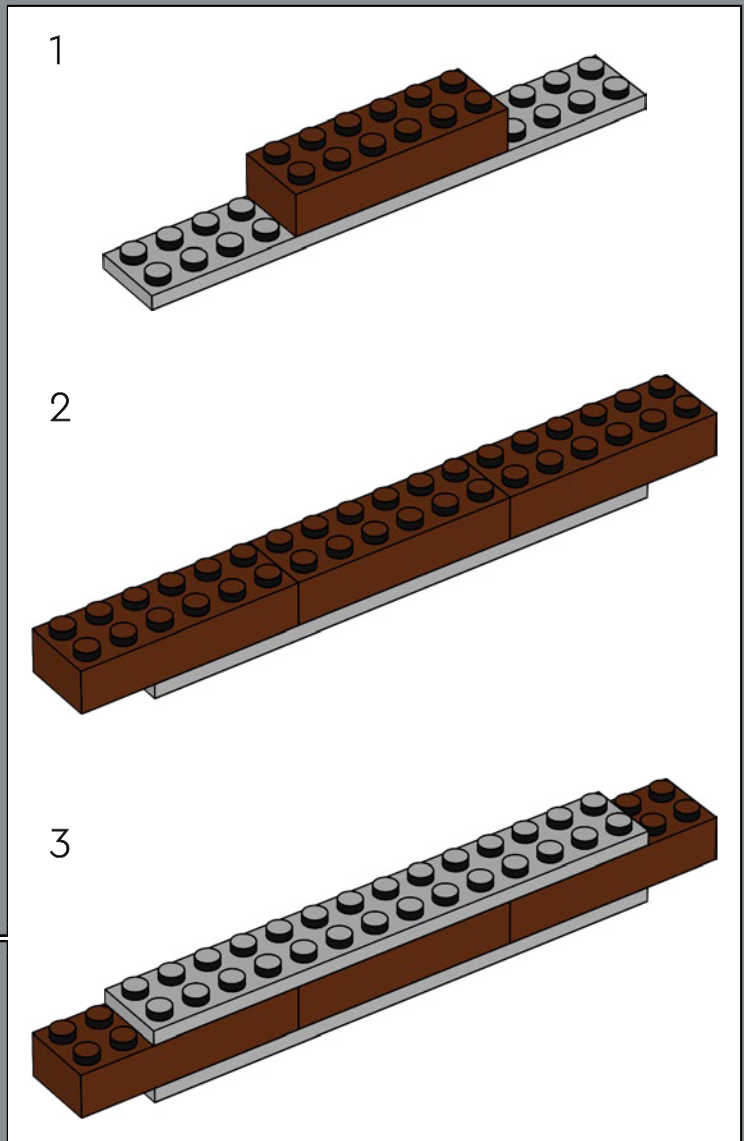
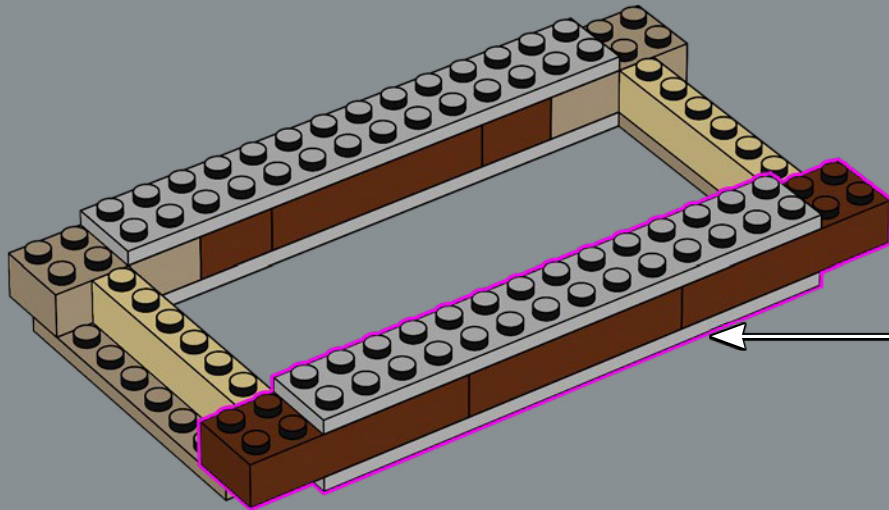

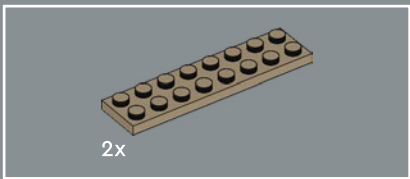

46

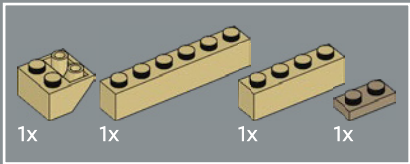
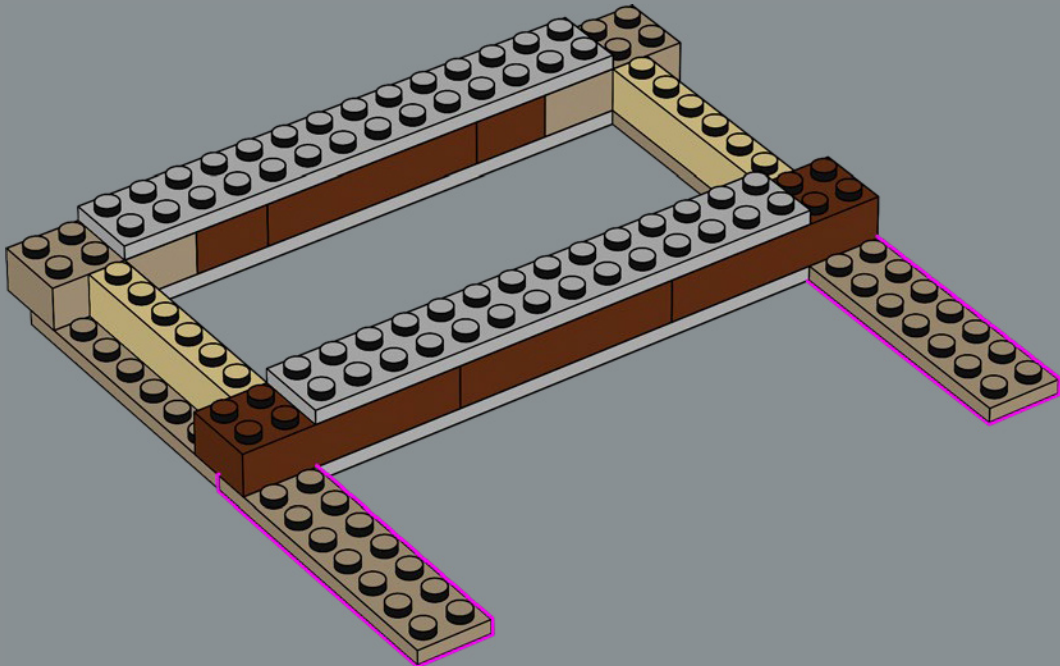

47

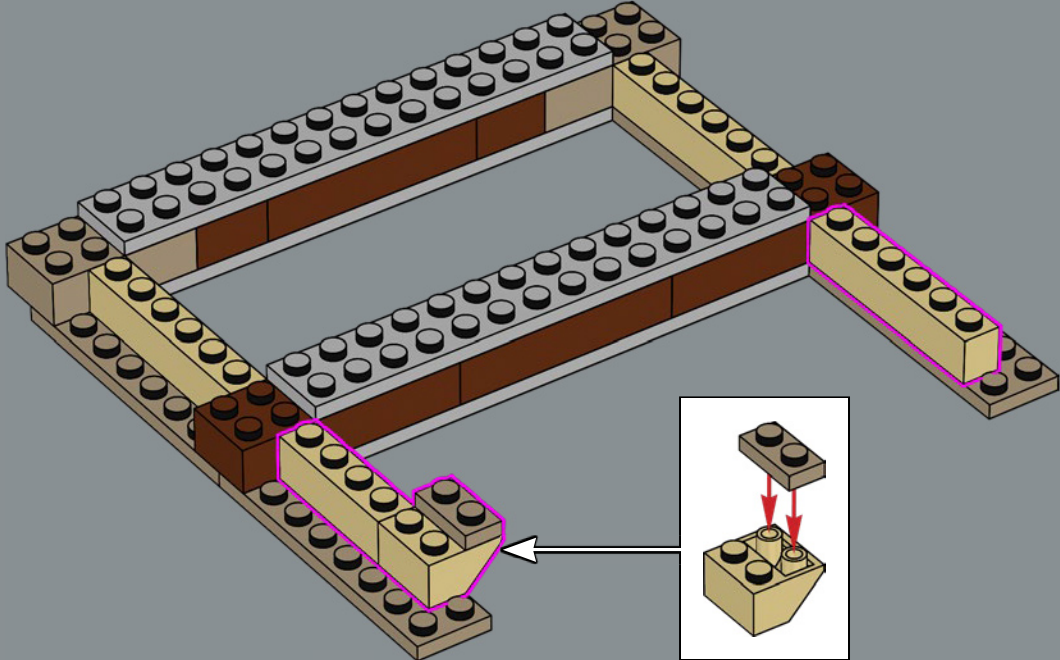

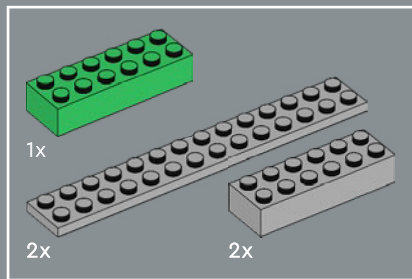

48

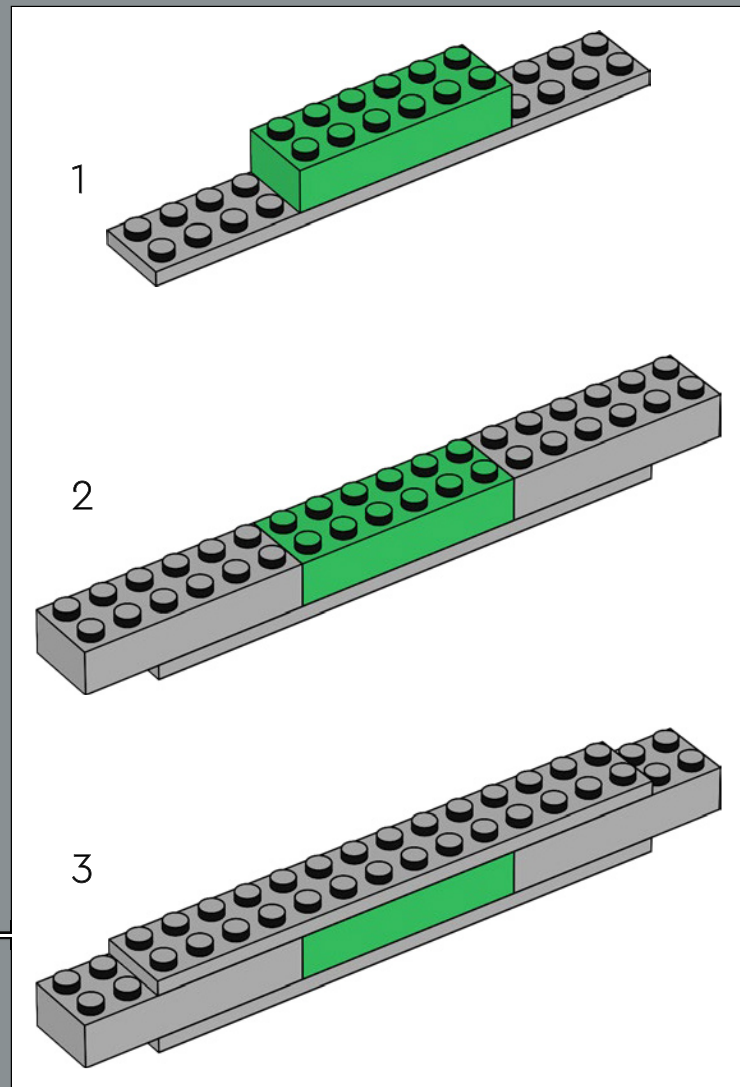
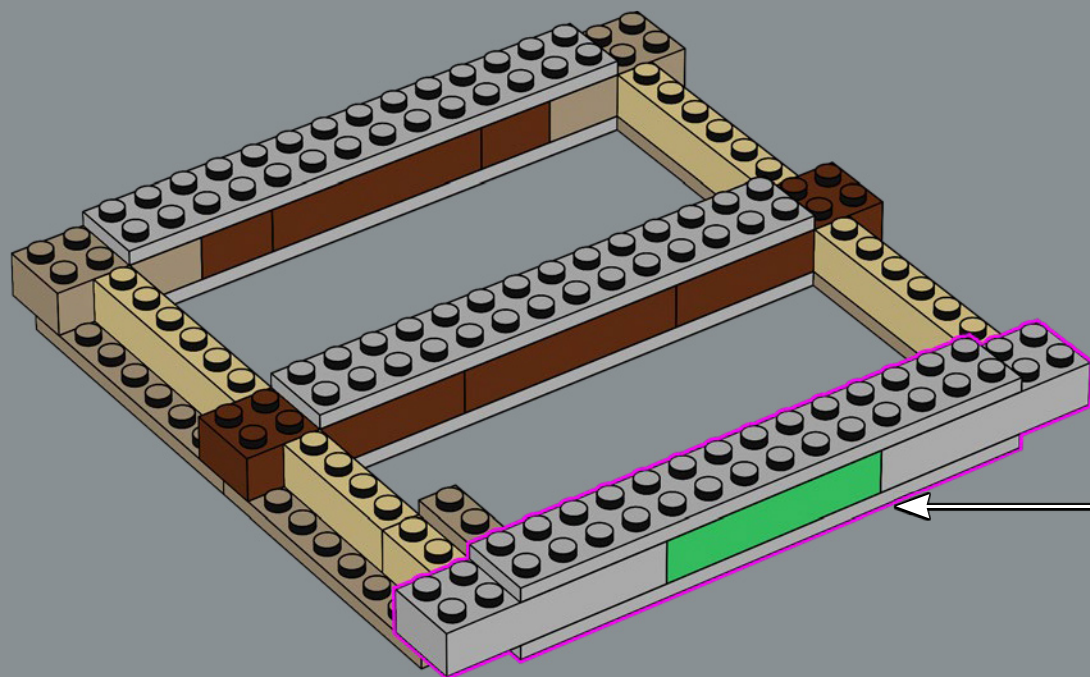

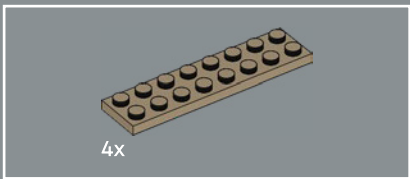

49

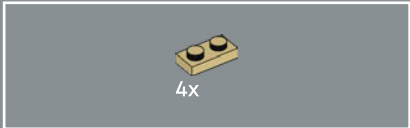
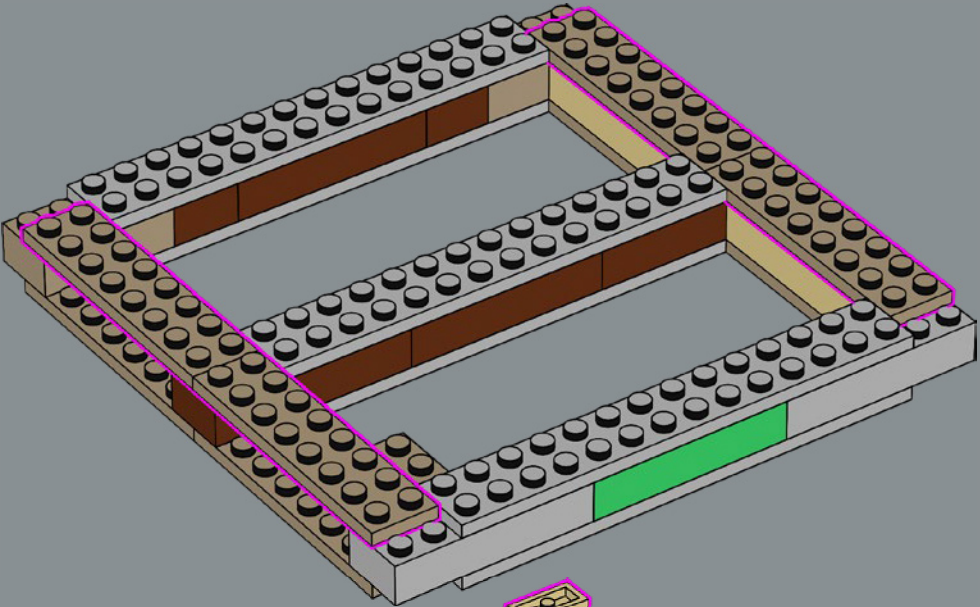

50

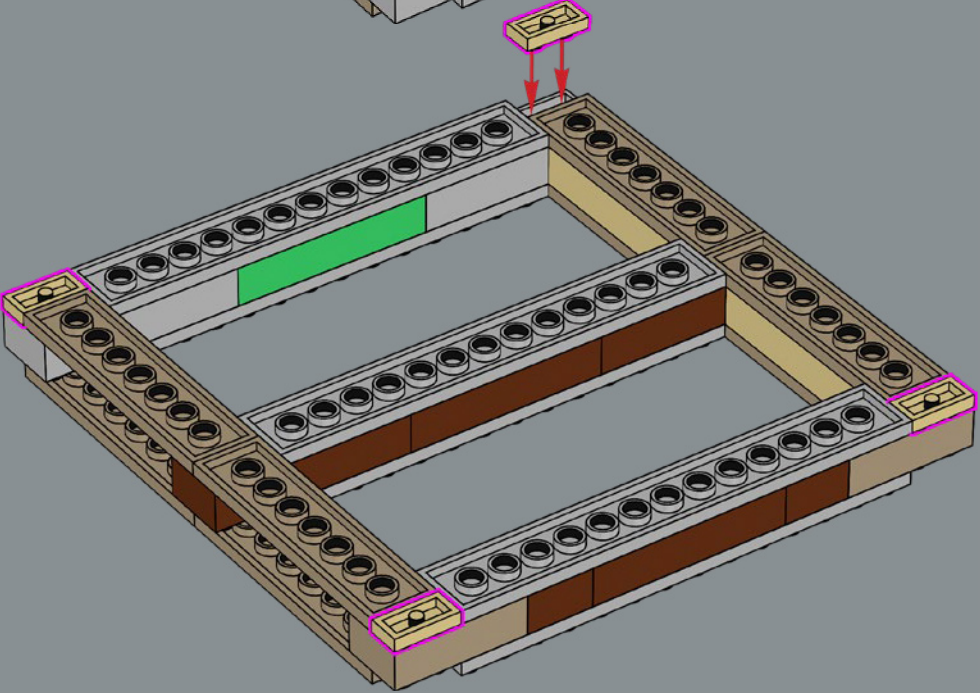



51

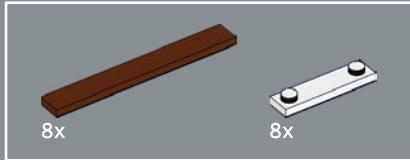
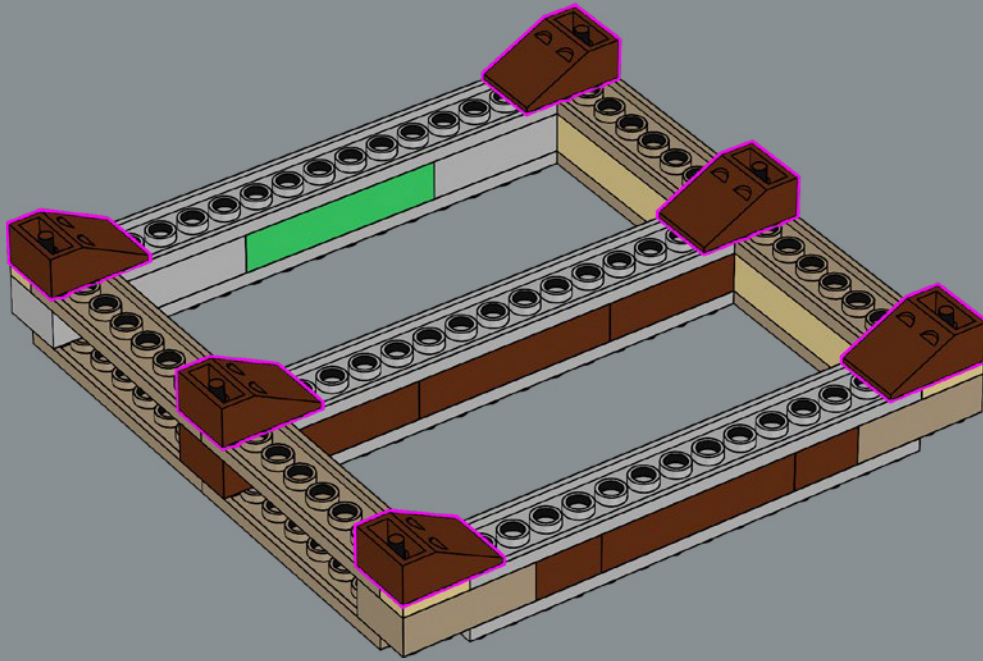

52

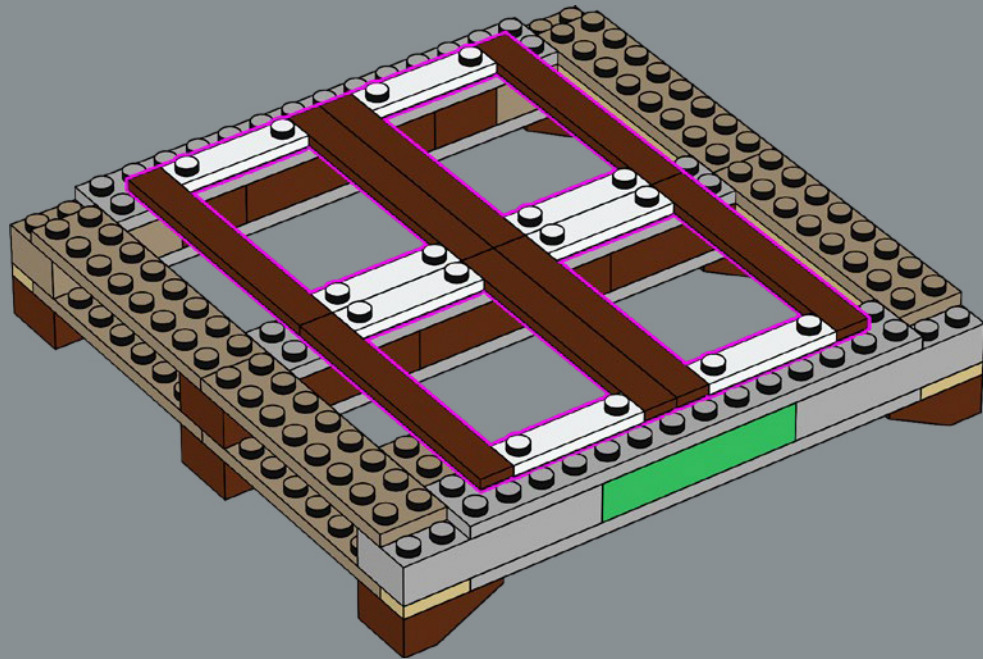

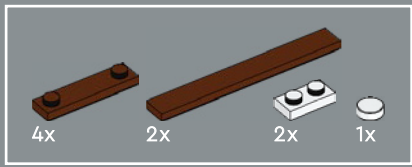

53

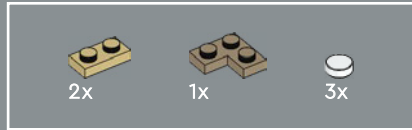
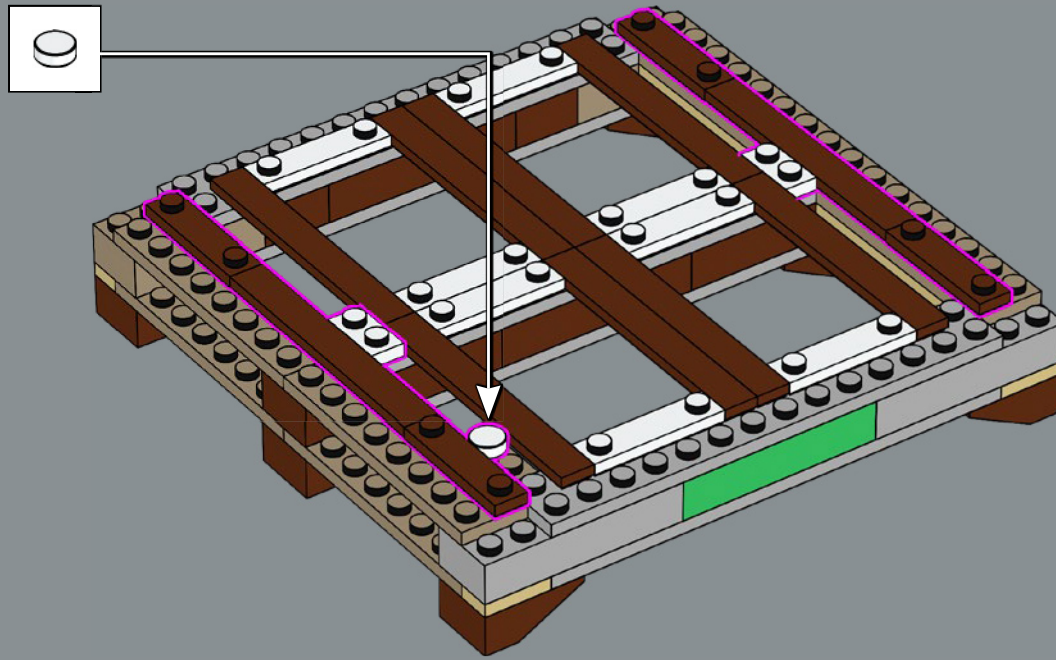

54

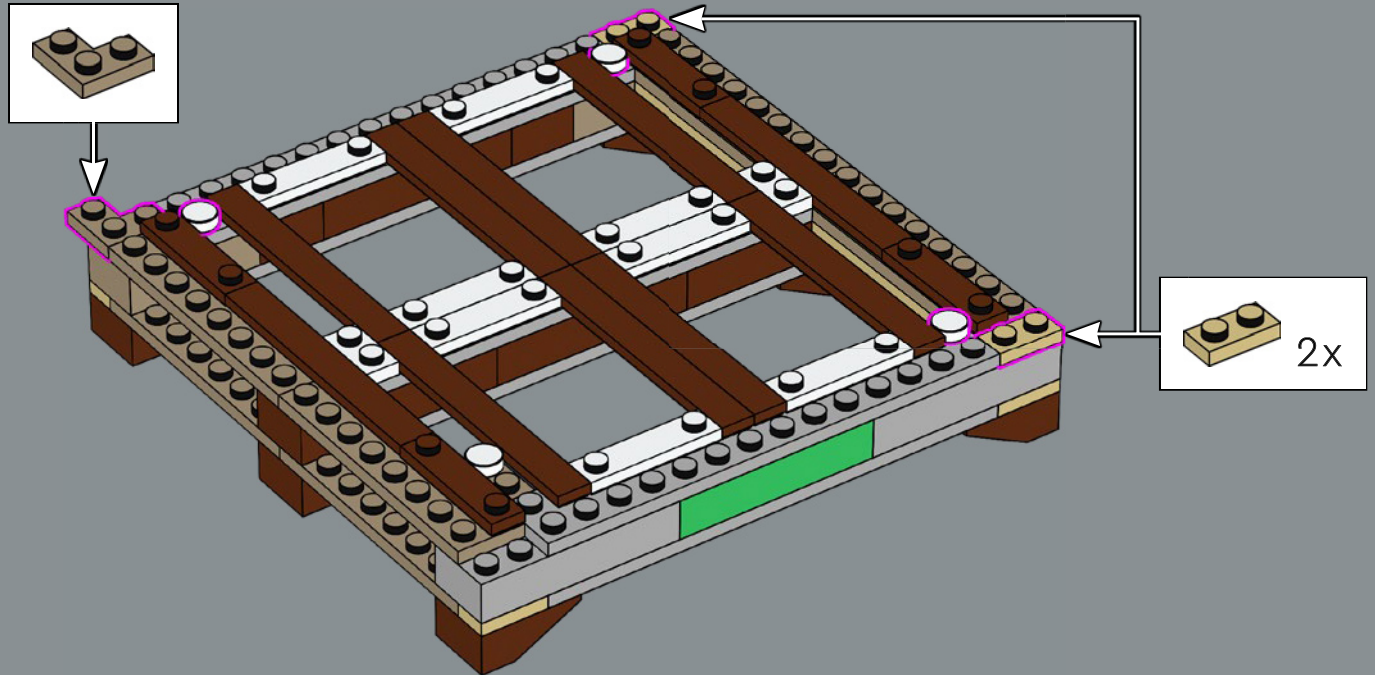

55

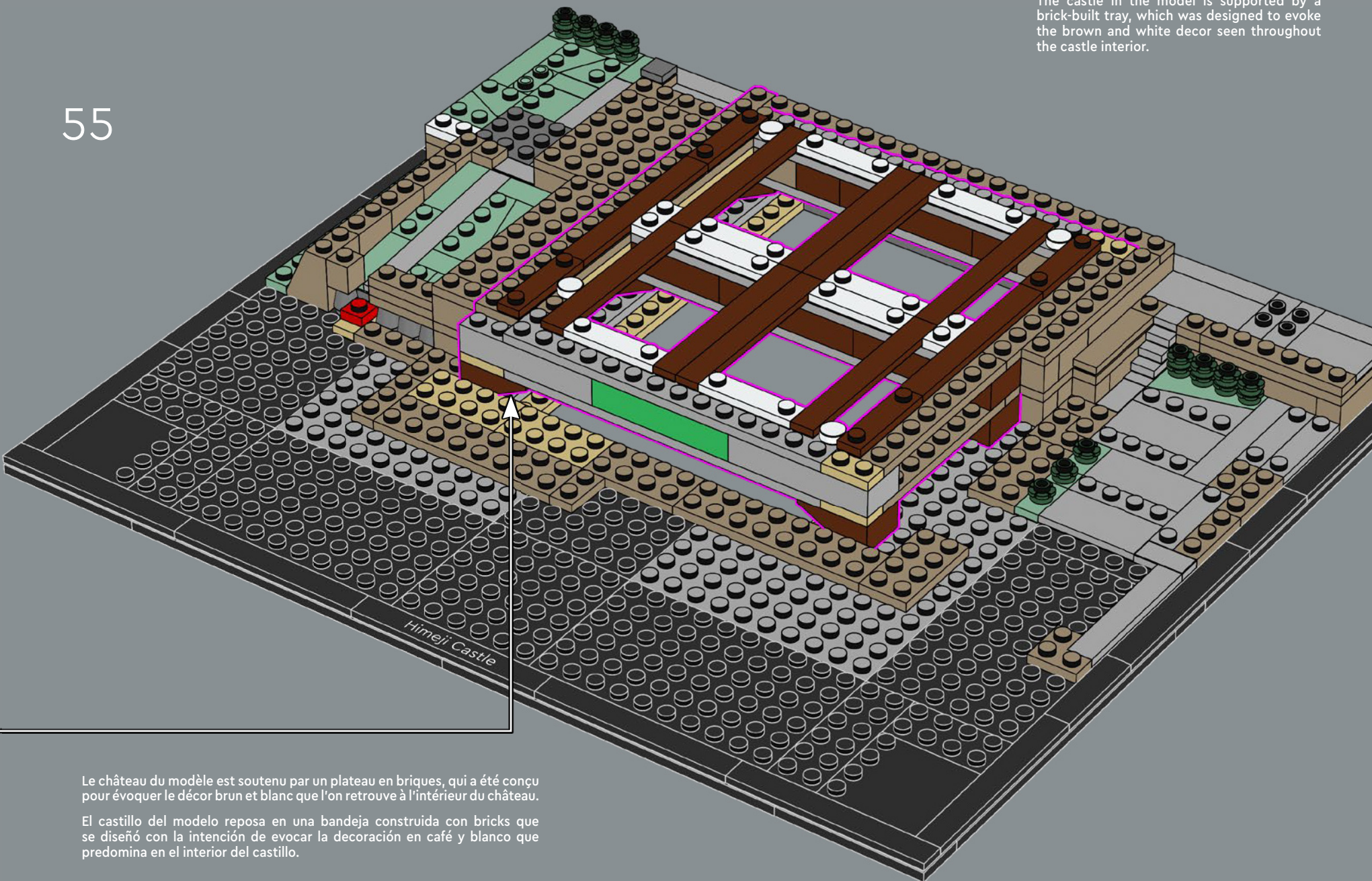

The castle in the model is supported by a brick-built tray, which was designed to evoke the brown and white decor seen throughout the castle interior.

Le château du modèle est soutenu par un plateau en briques, qui a été conçu pour évoquer le décor brun et blanc que l'on retrouve à l'intérieur du château.

El castillo del modelo reposa en una bandeja construida con bricks que se diseñó con la intención de evocar la decoración en café y blanco que predomina en el interior del castillo.

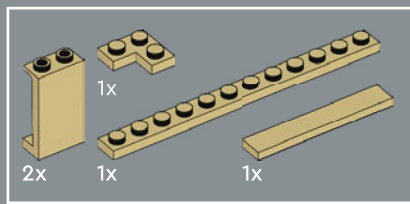

56

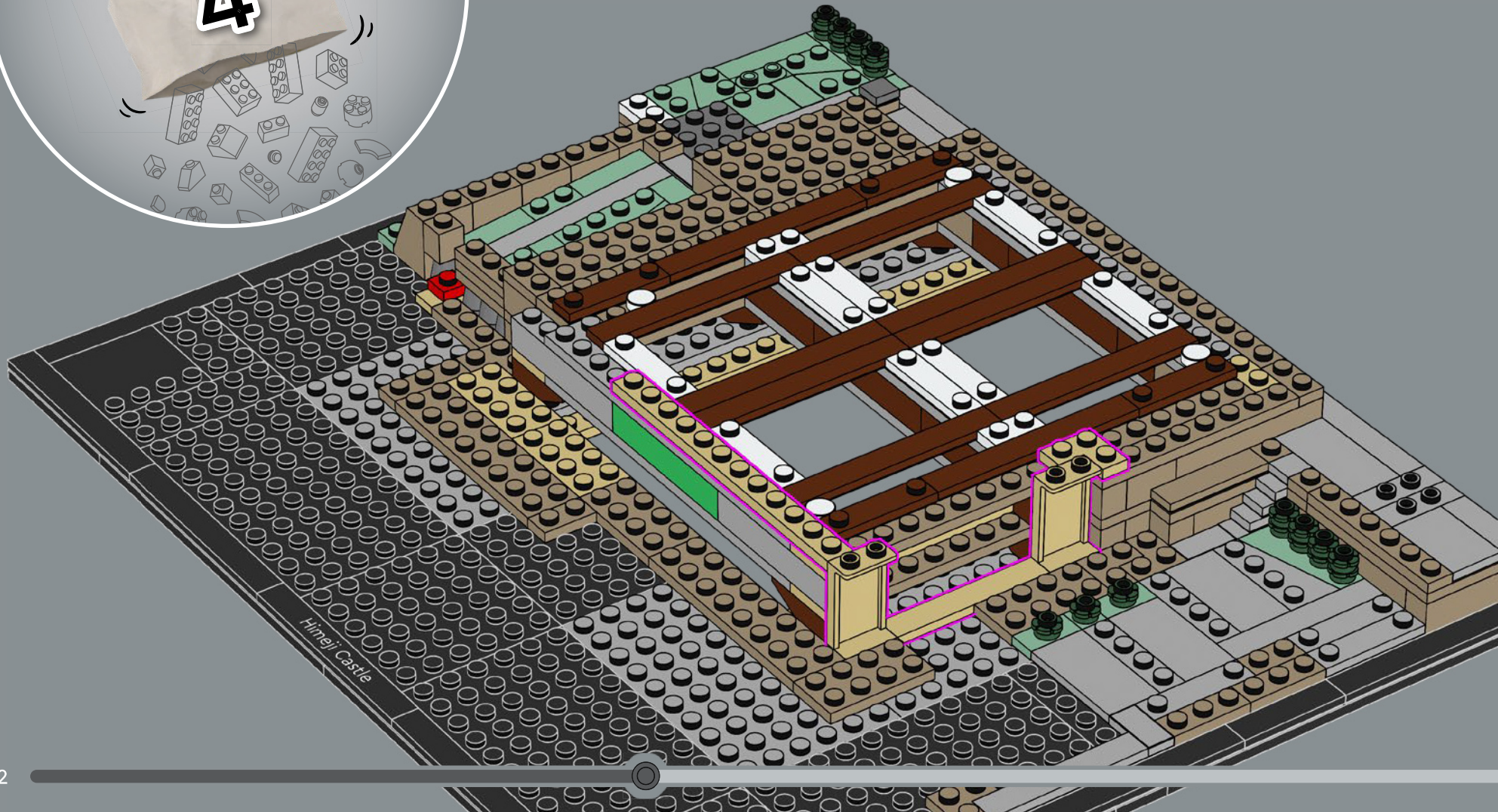

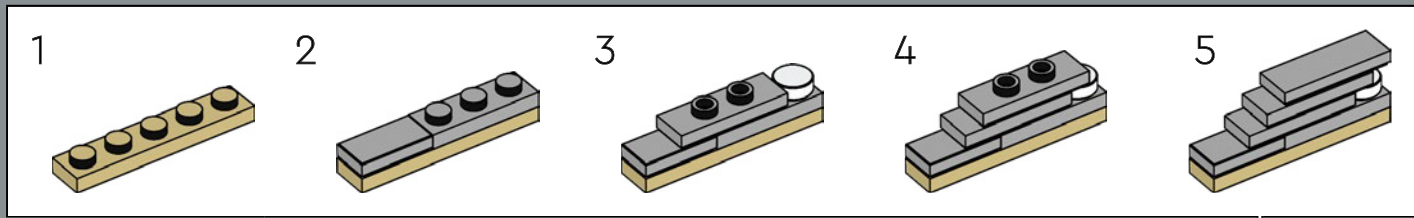
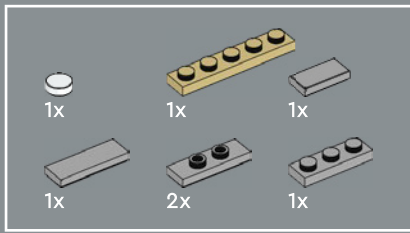

57

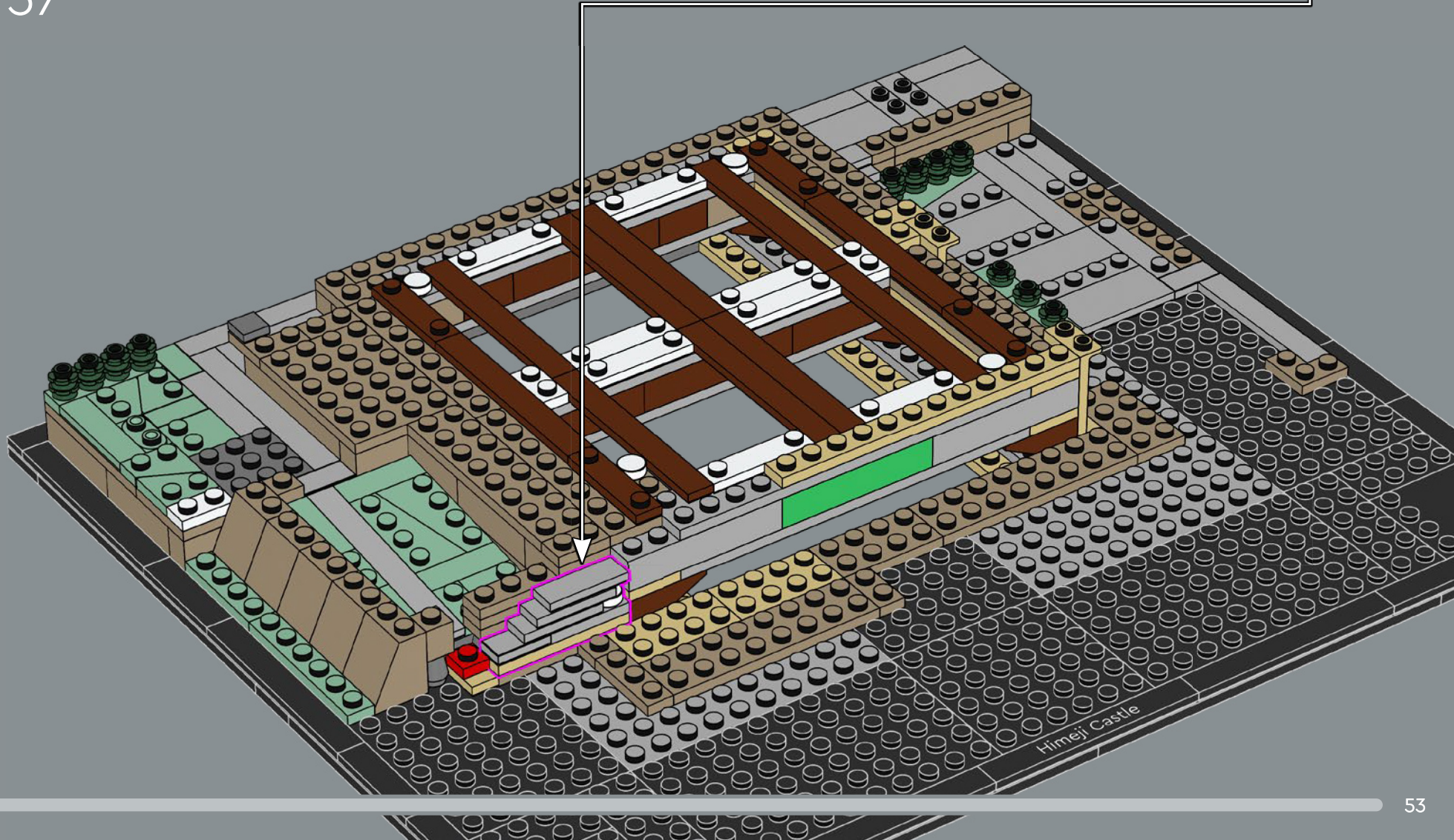

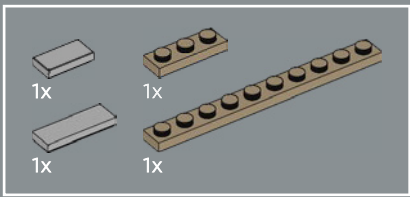

58

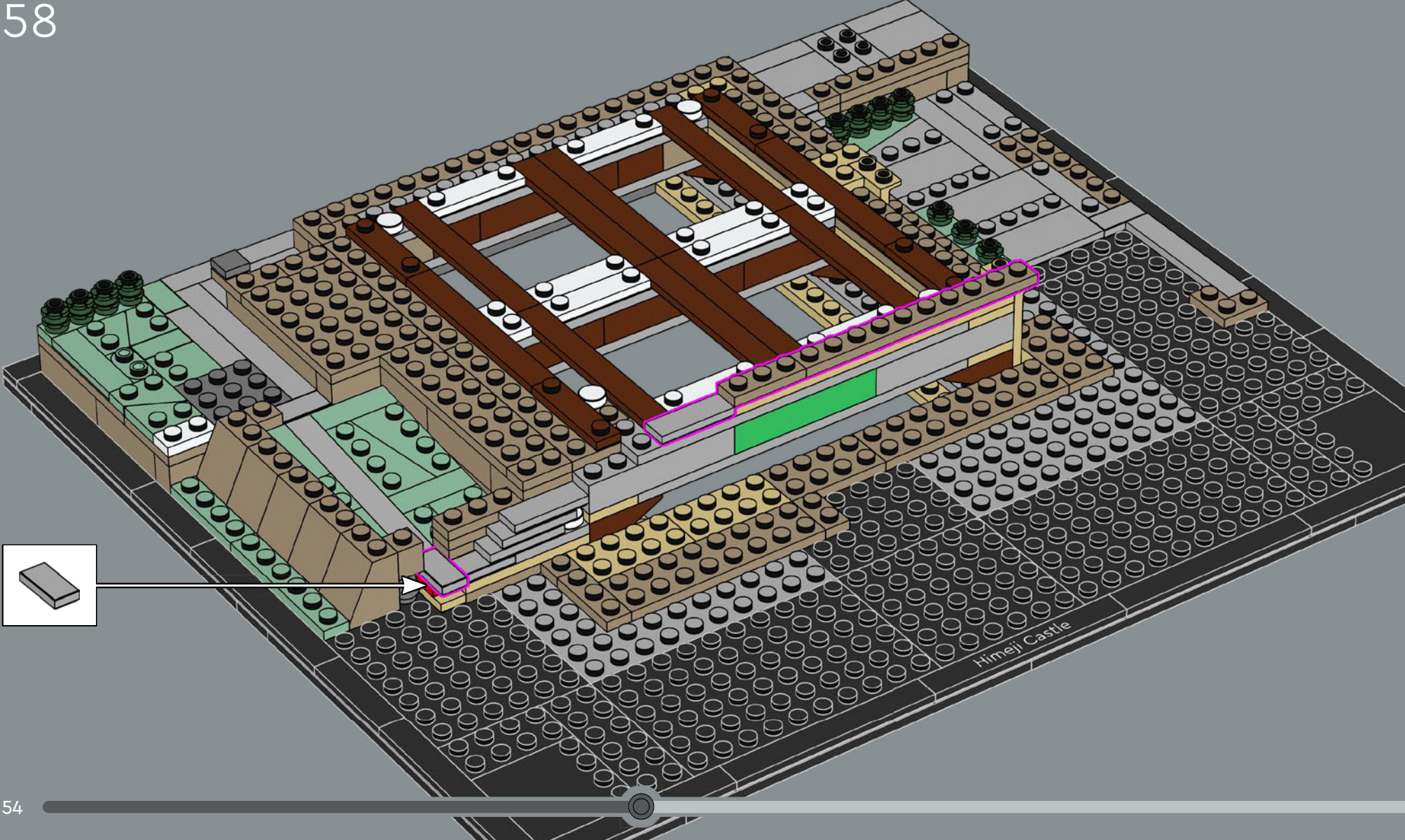

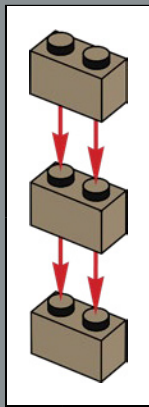
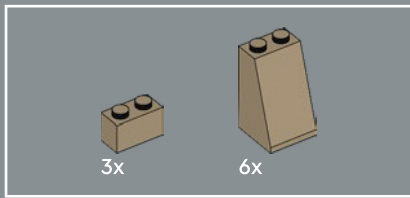

59

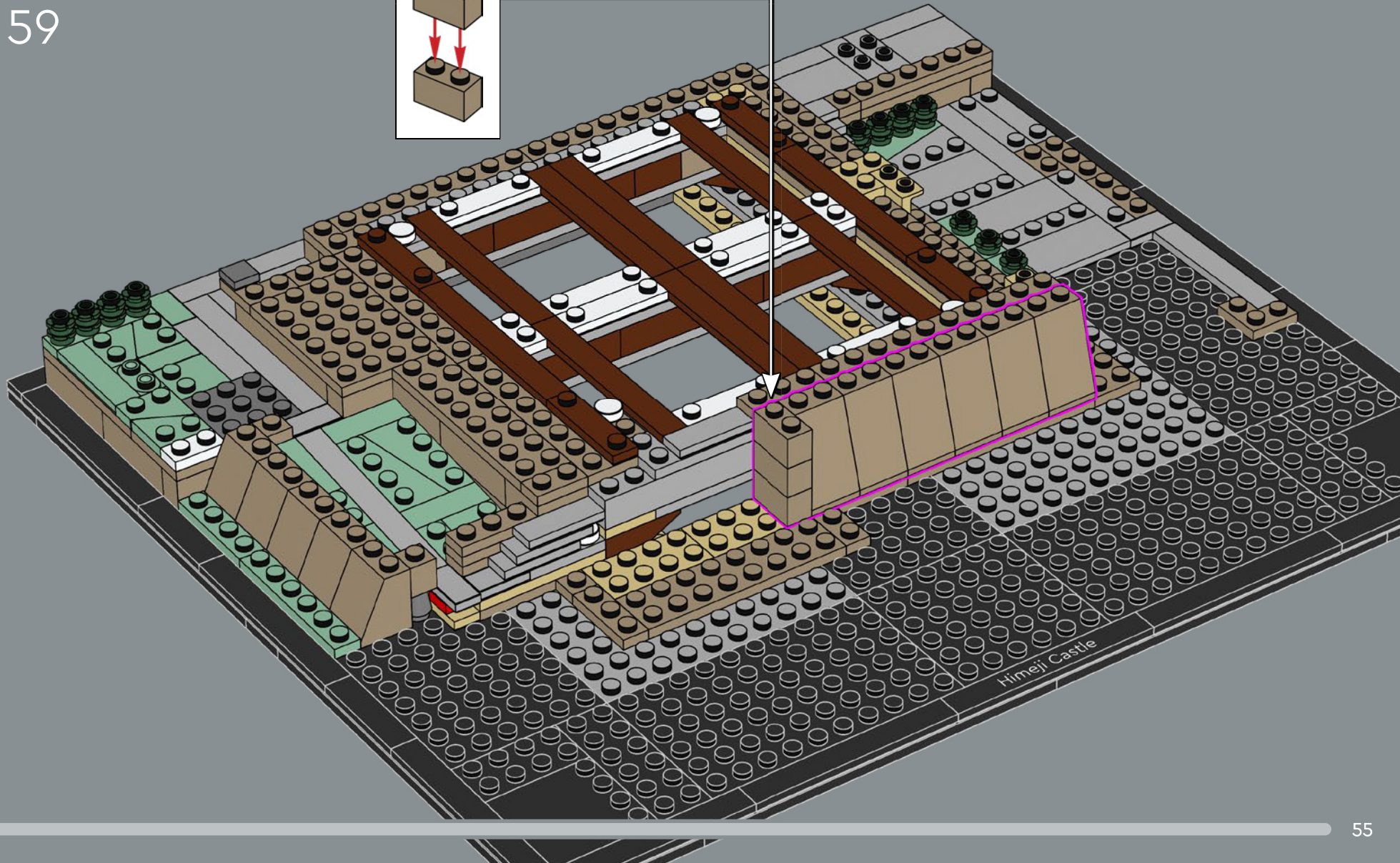

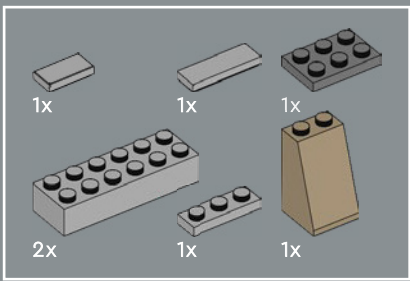

60

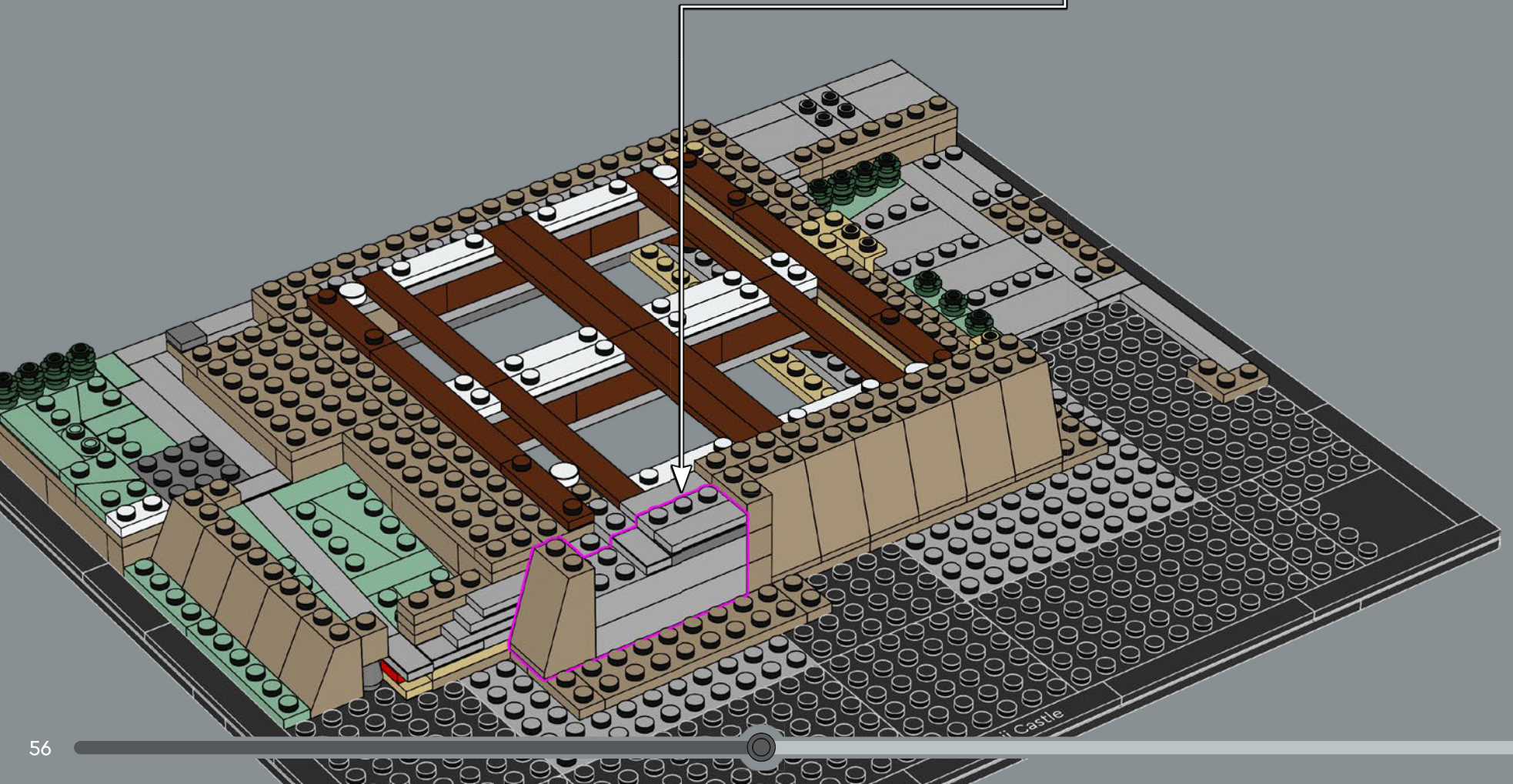
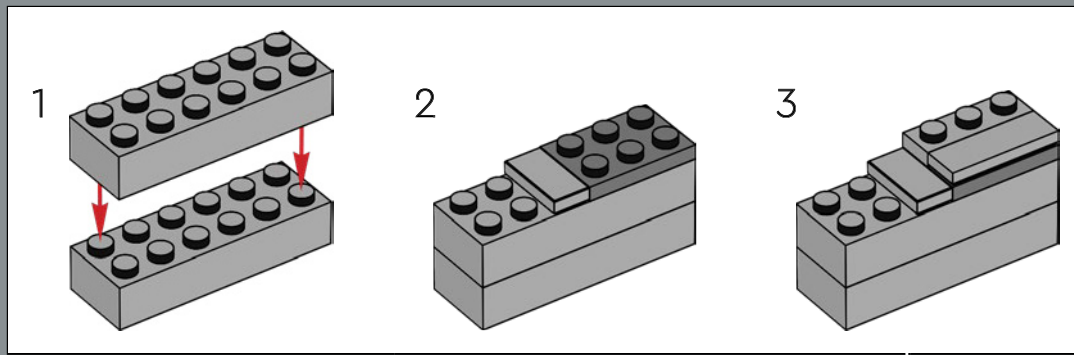

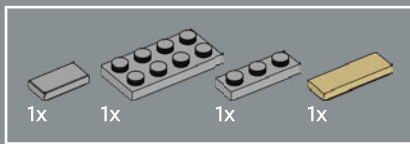

61

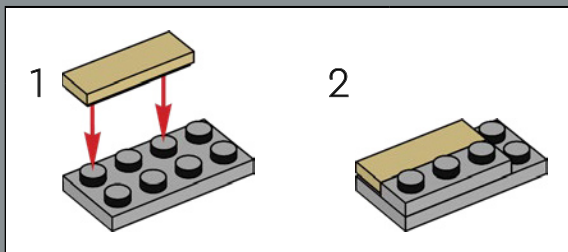
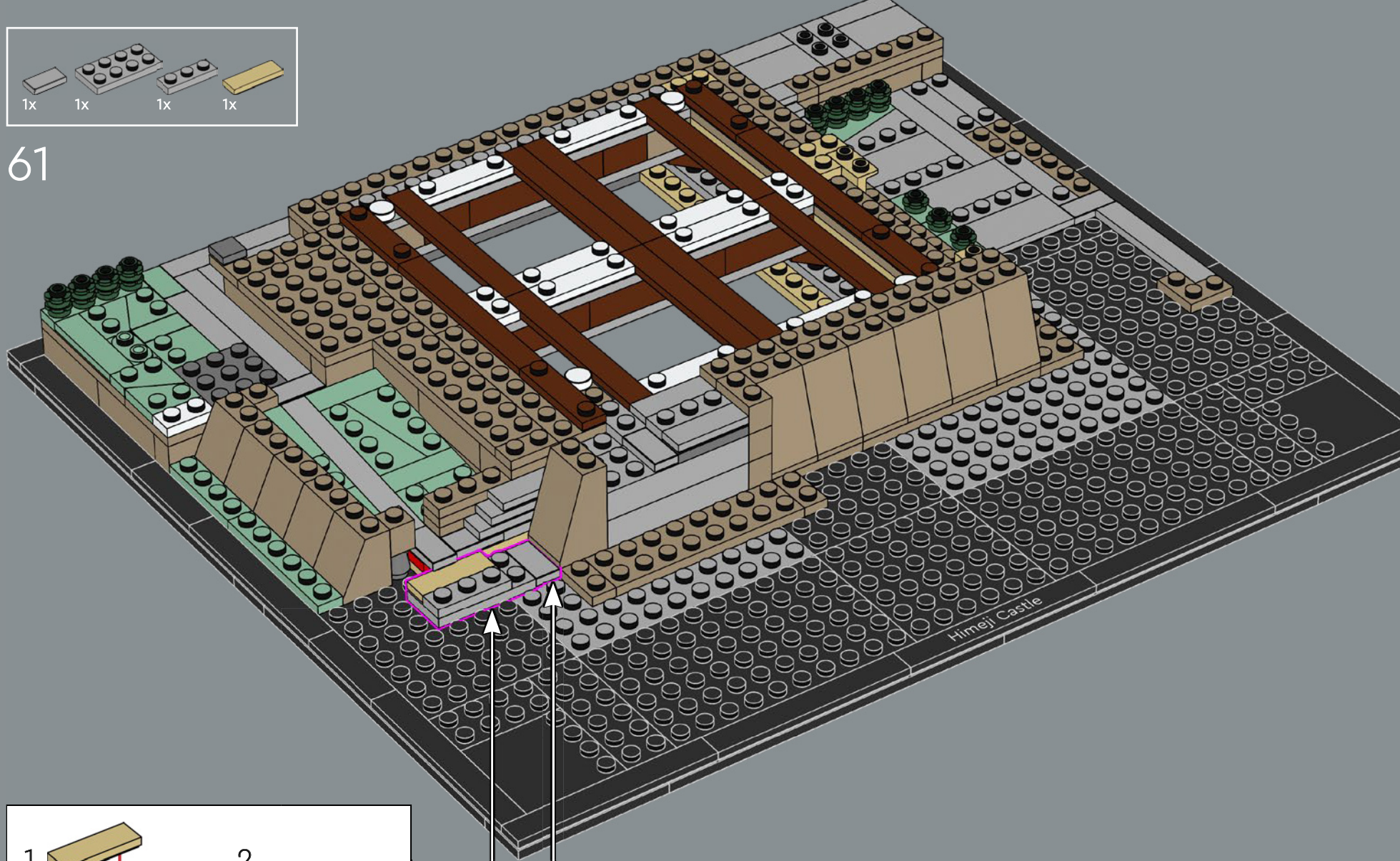

2

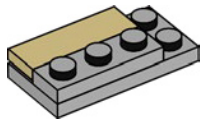

Himeji Castle

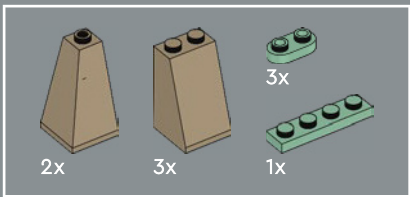

62

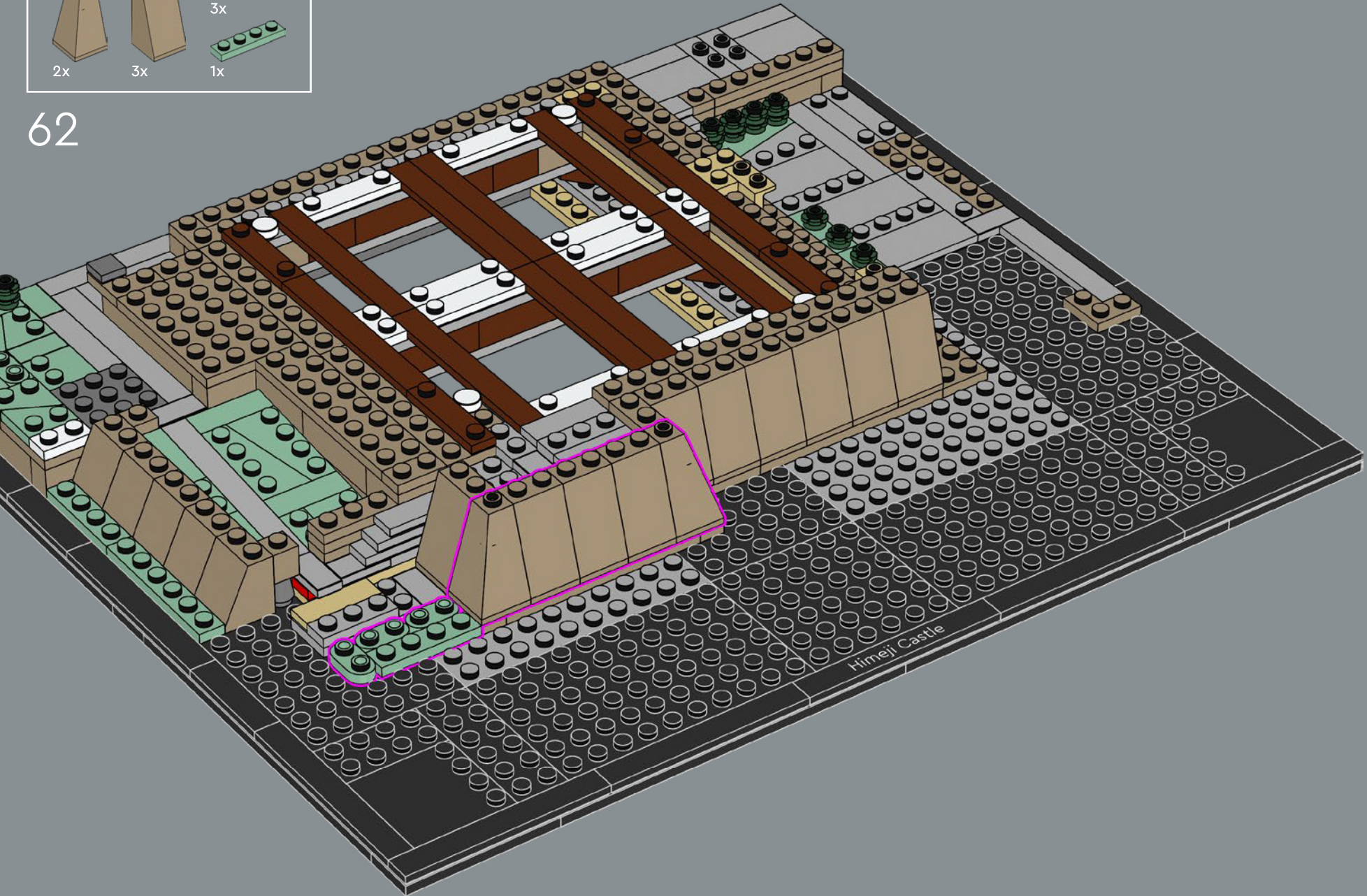

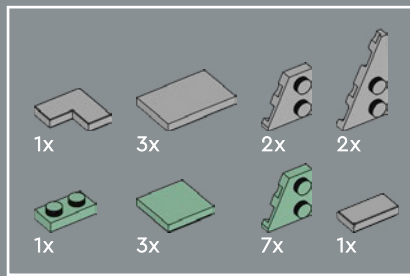

63

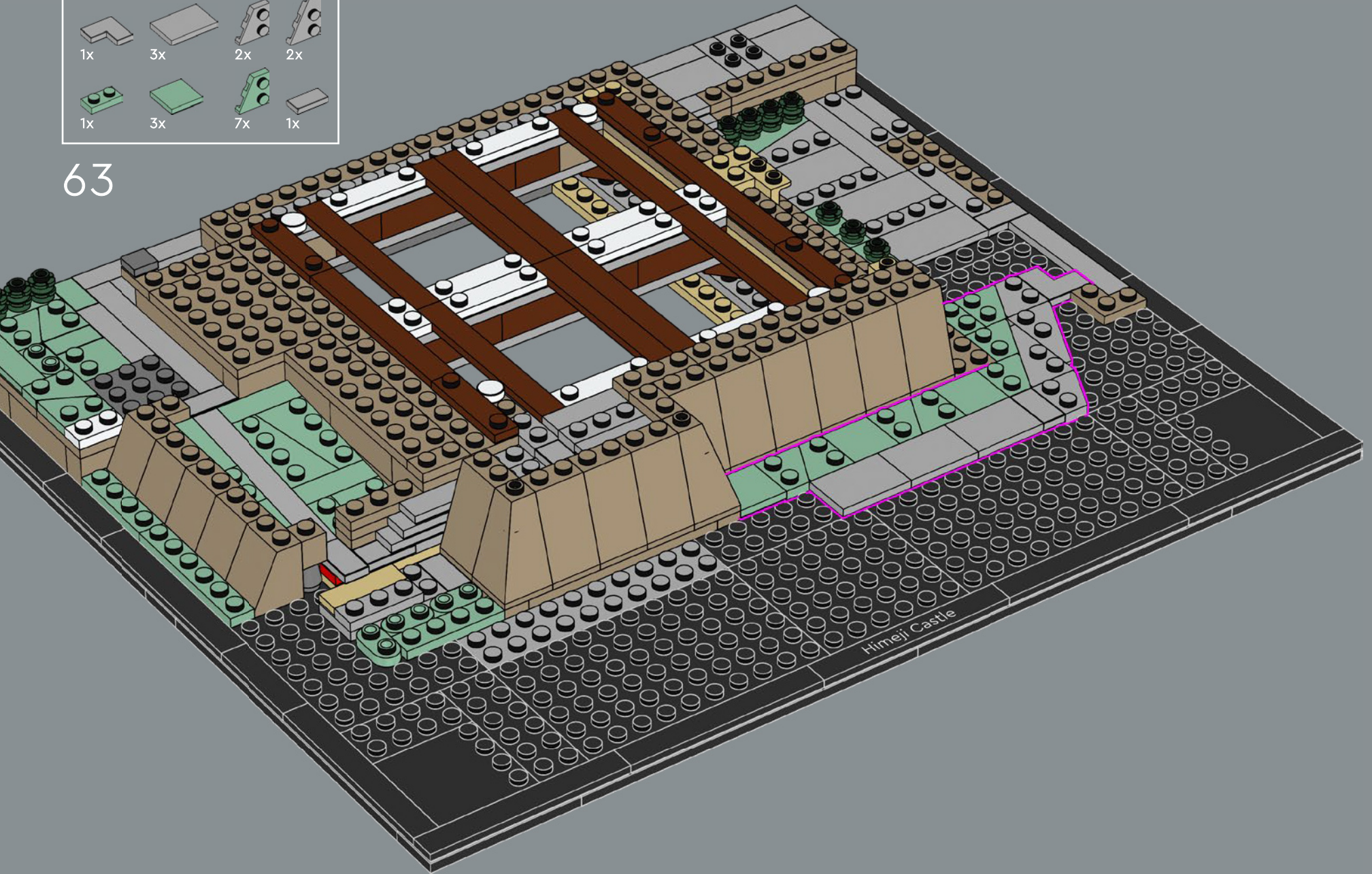

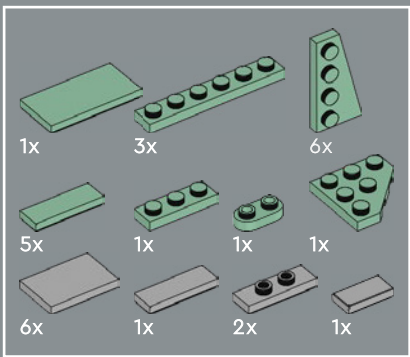

64

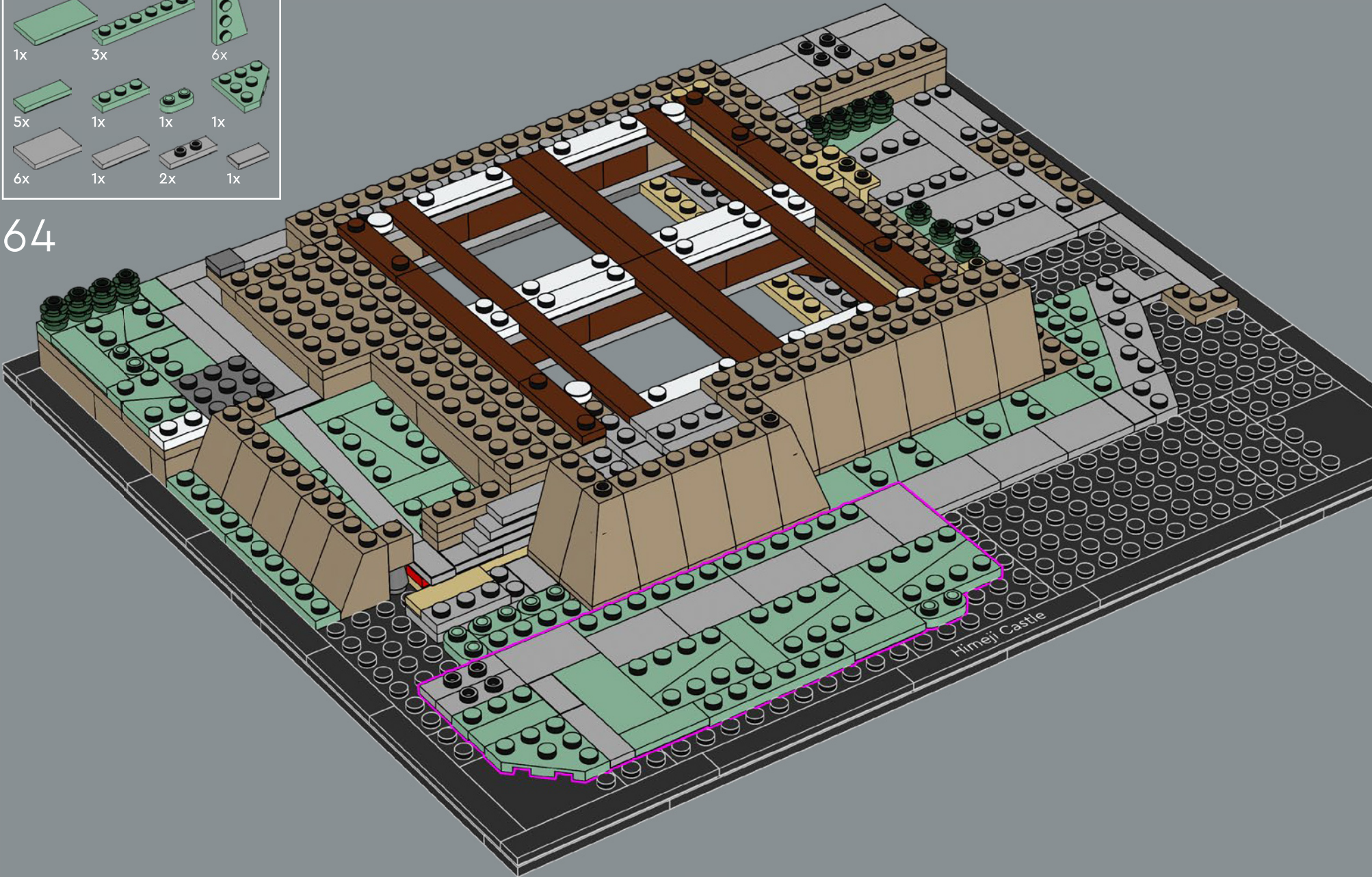

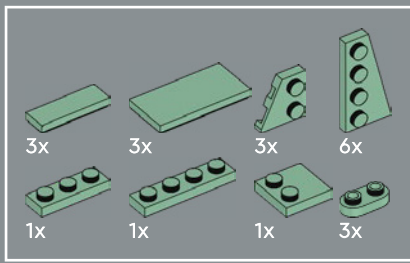

65

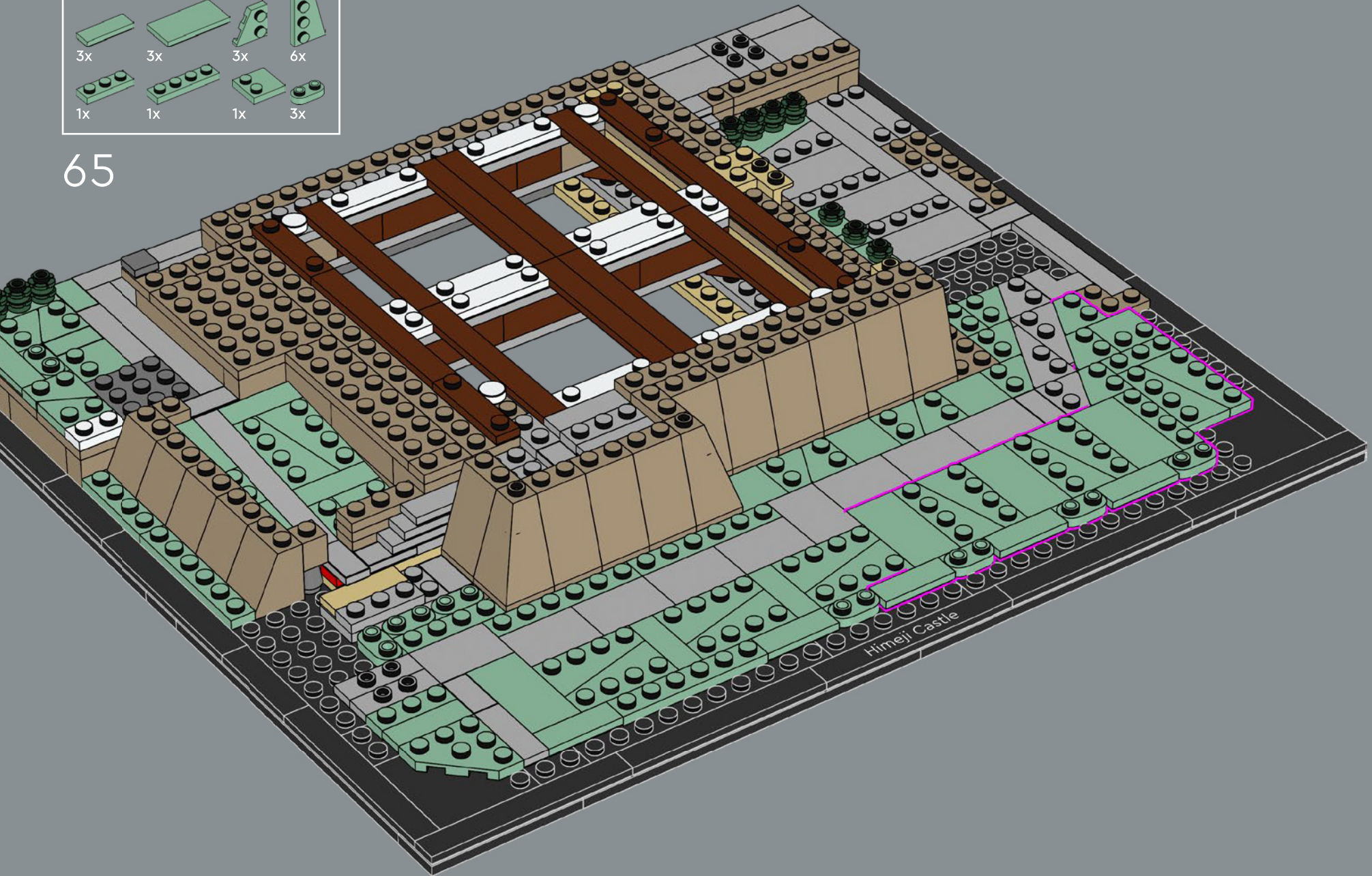

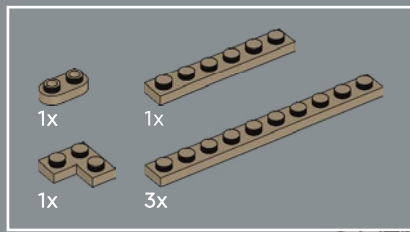

66

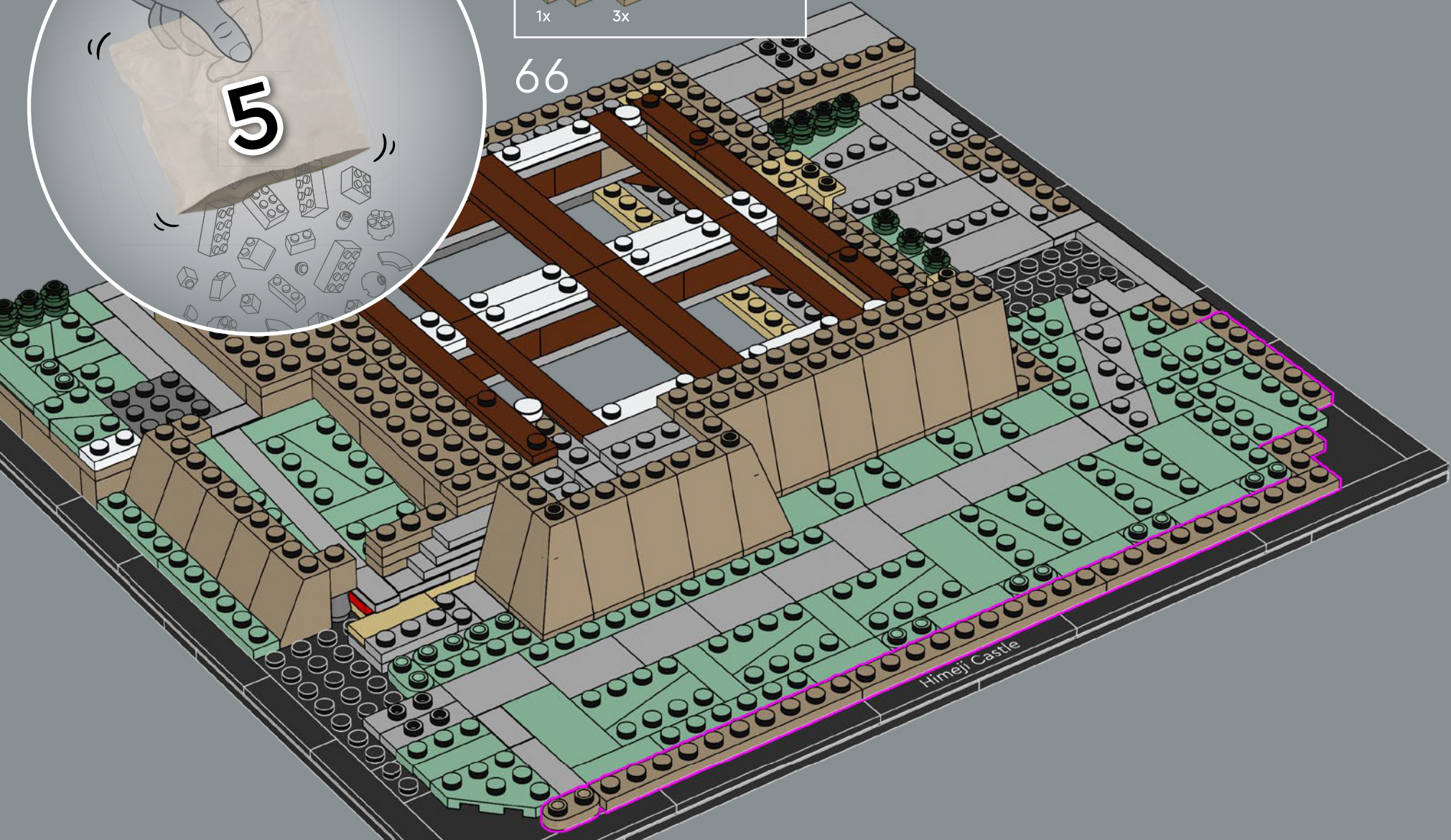

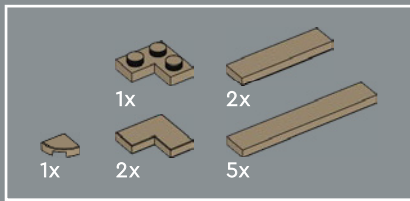

67

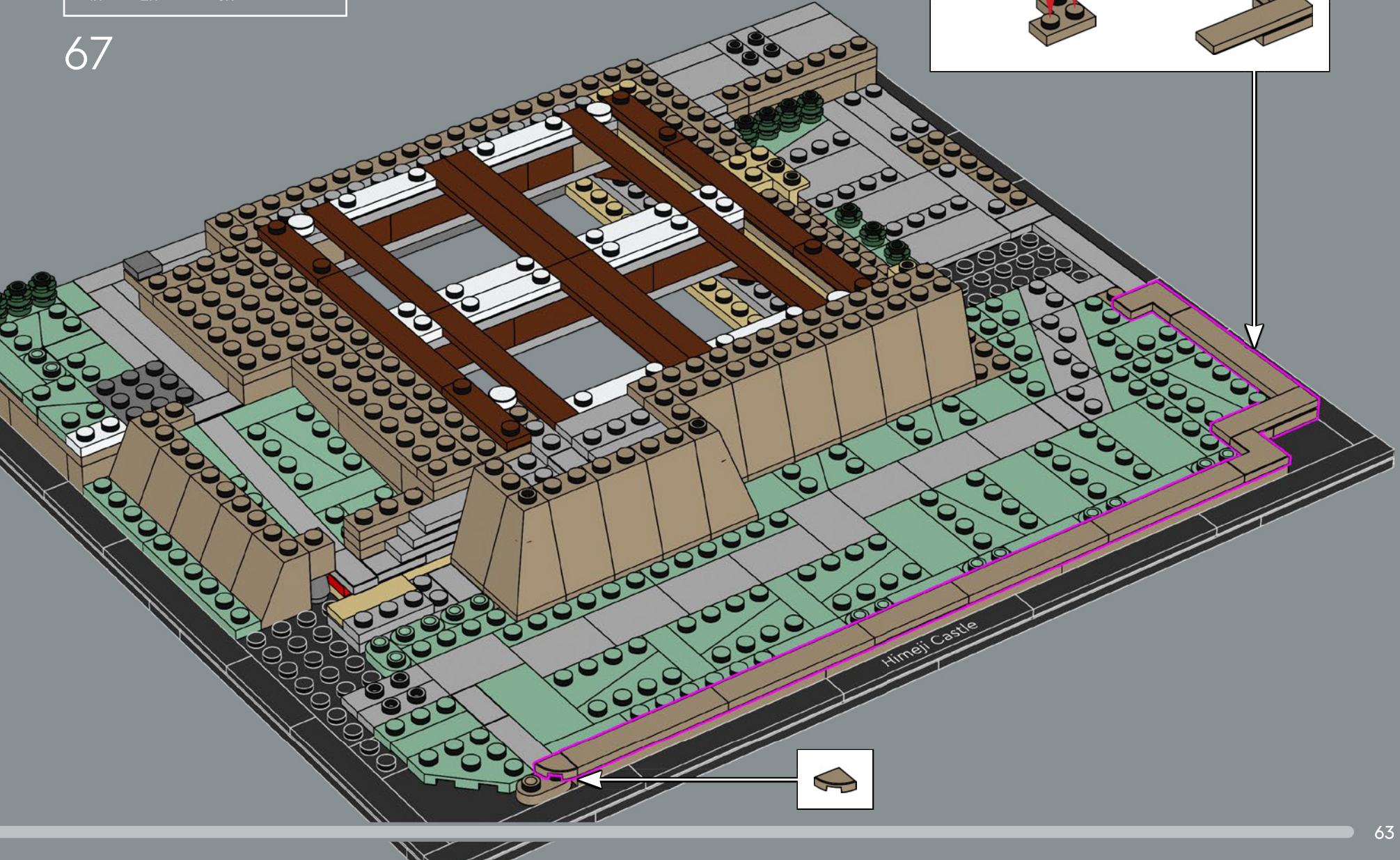
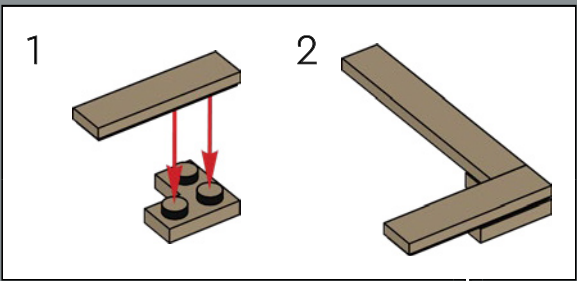

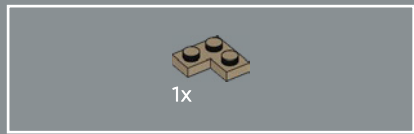

68

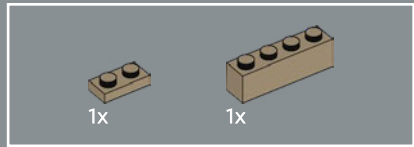
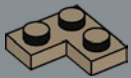

69

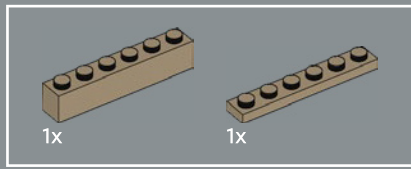
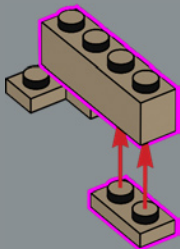

70

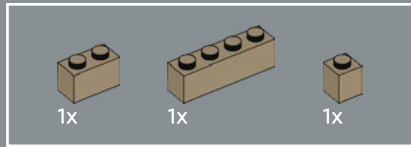
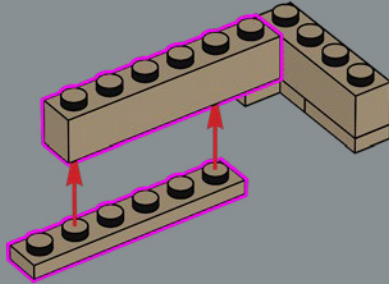

71

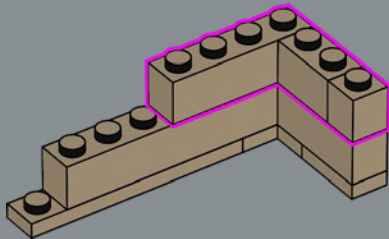

72

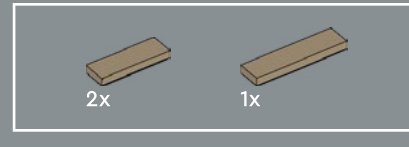
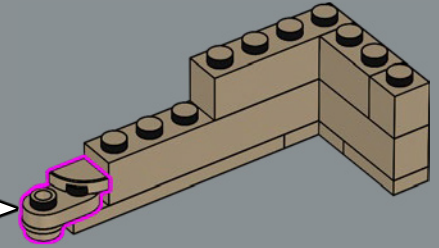
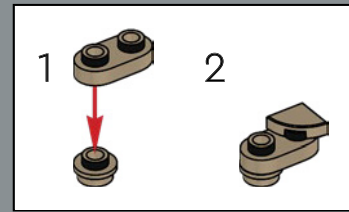

73

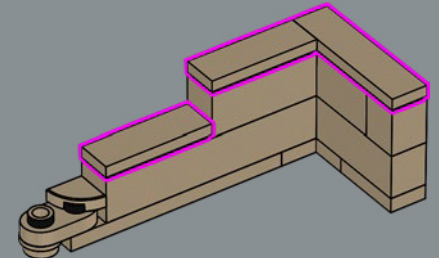

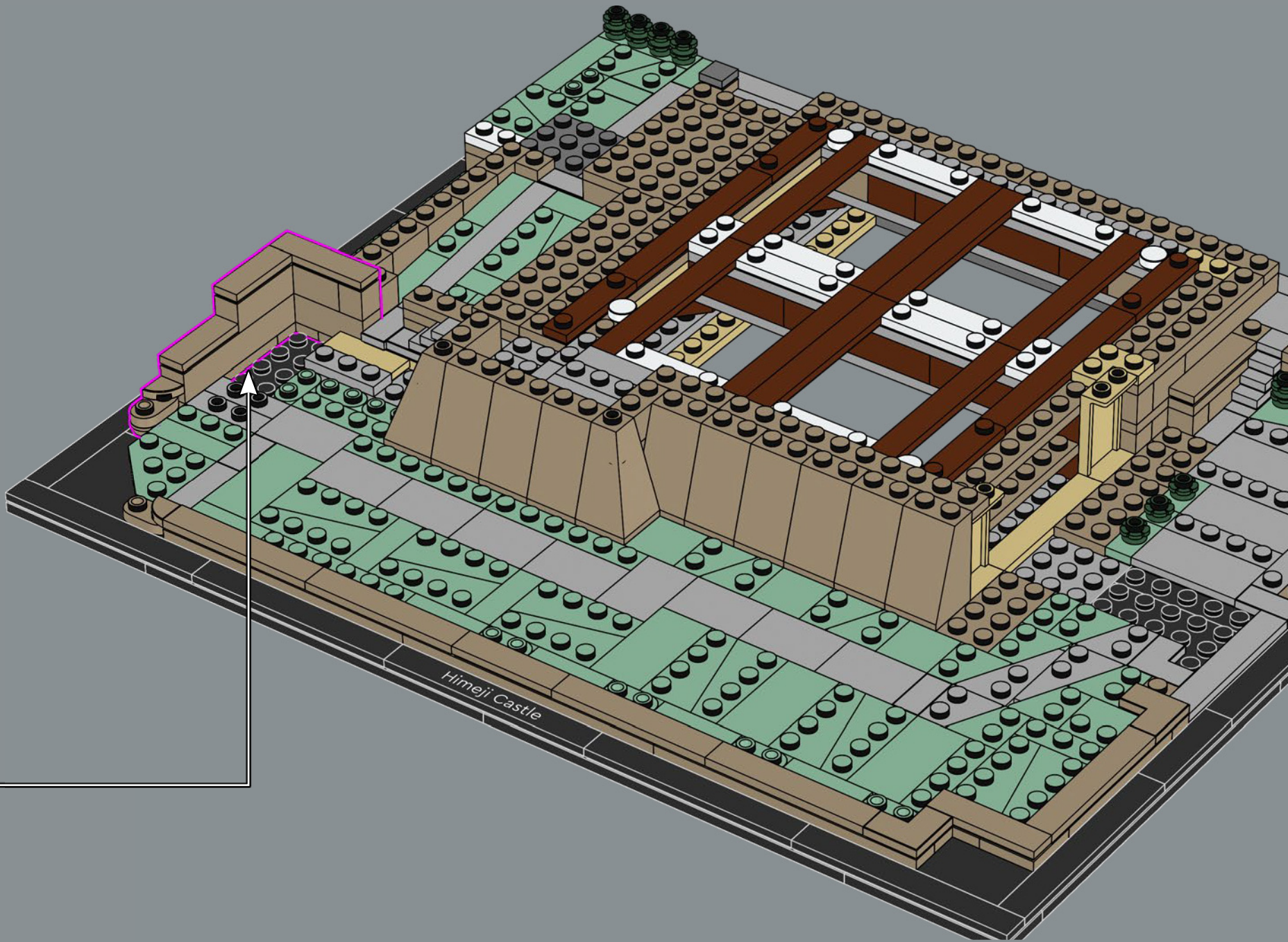

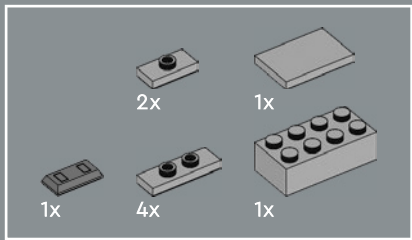

75

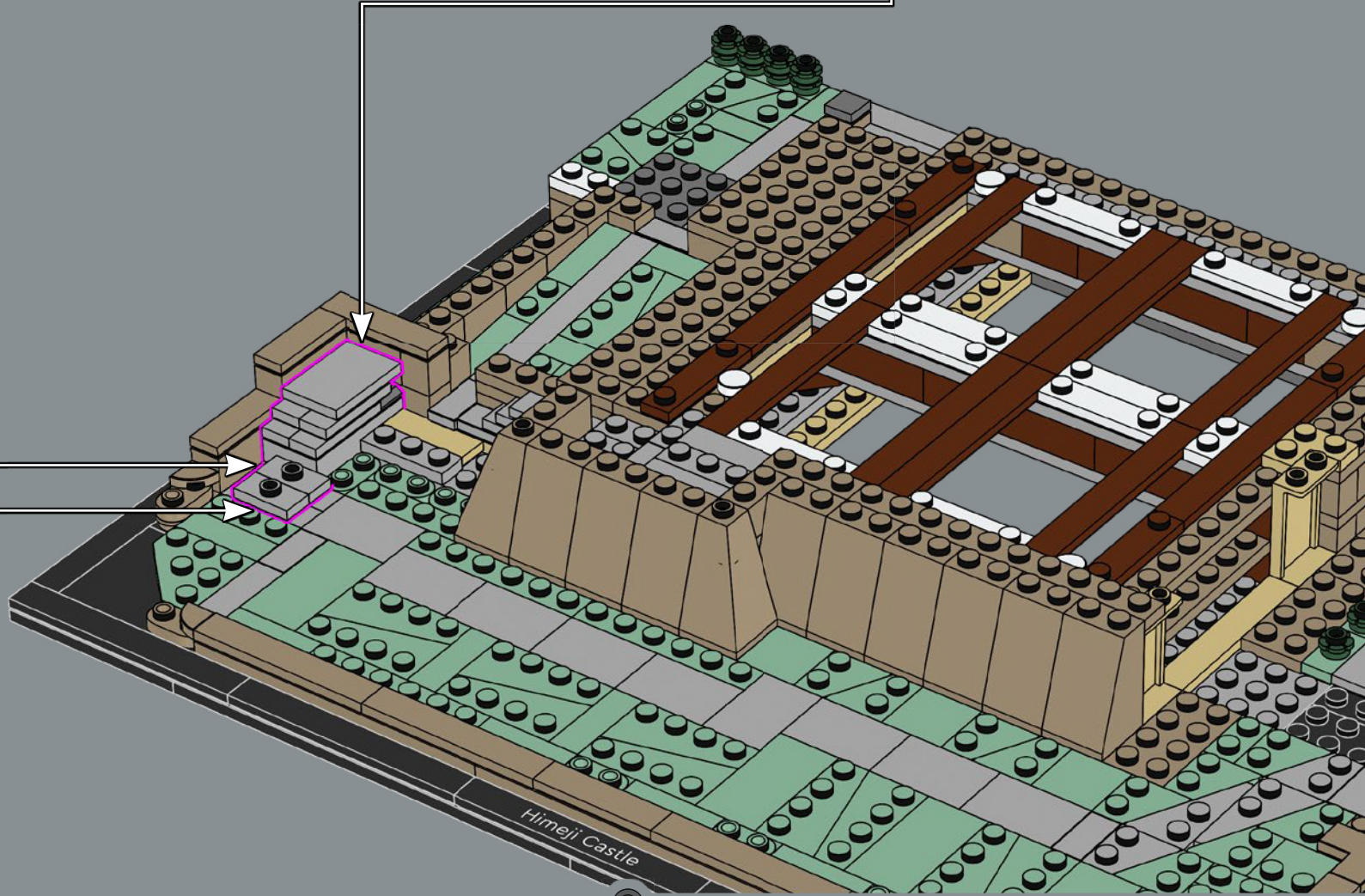
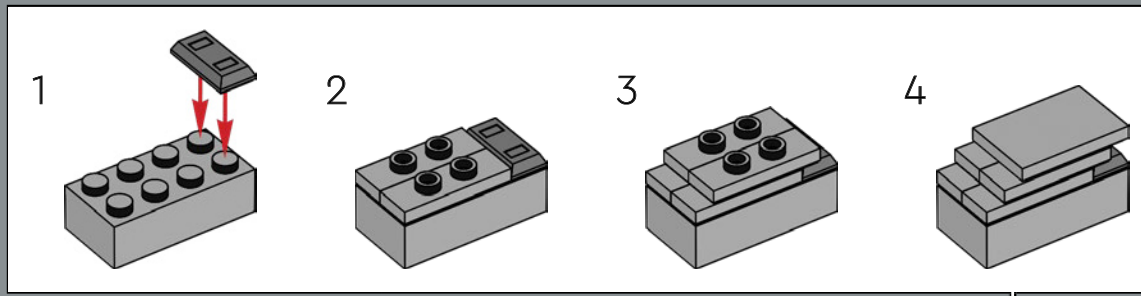

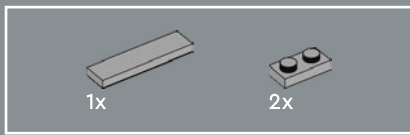

76

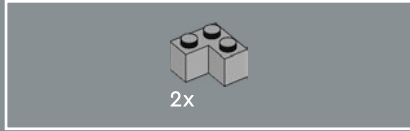
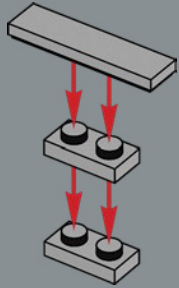

77

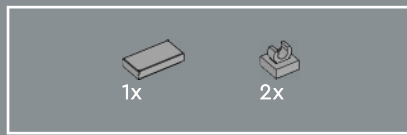
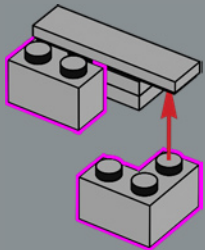

78

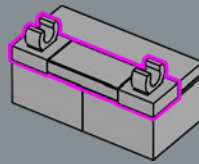

79

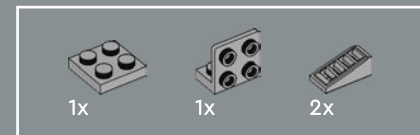
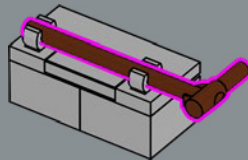

80

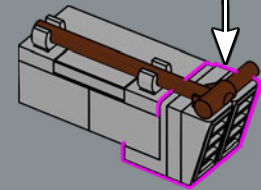
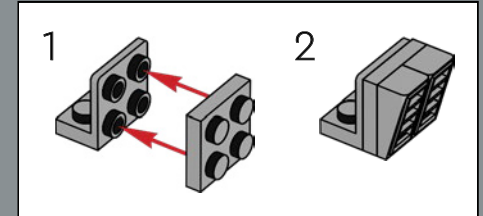

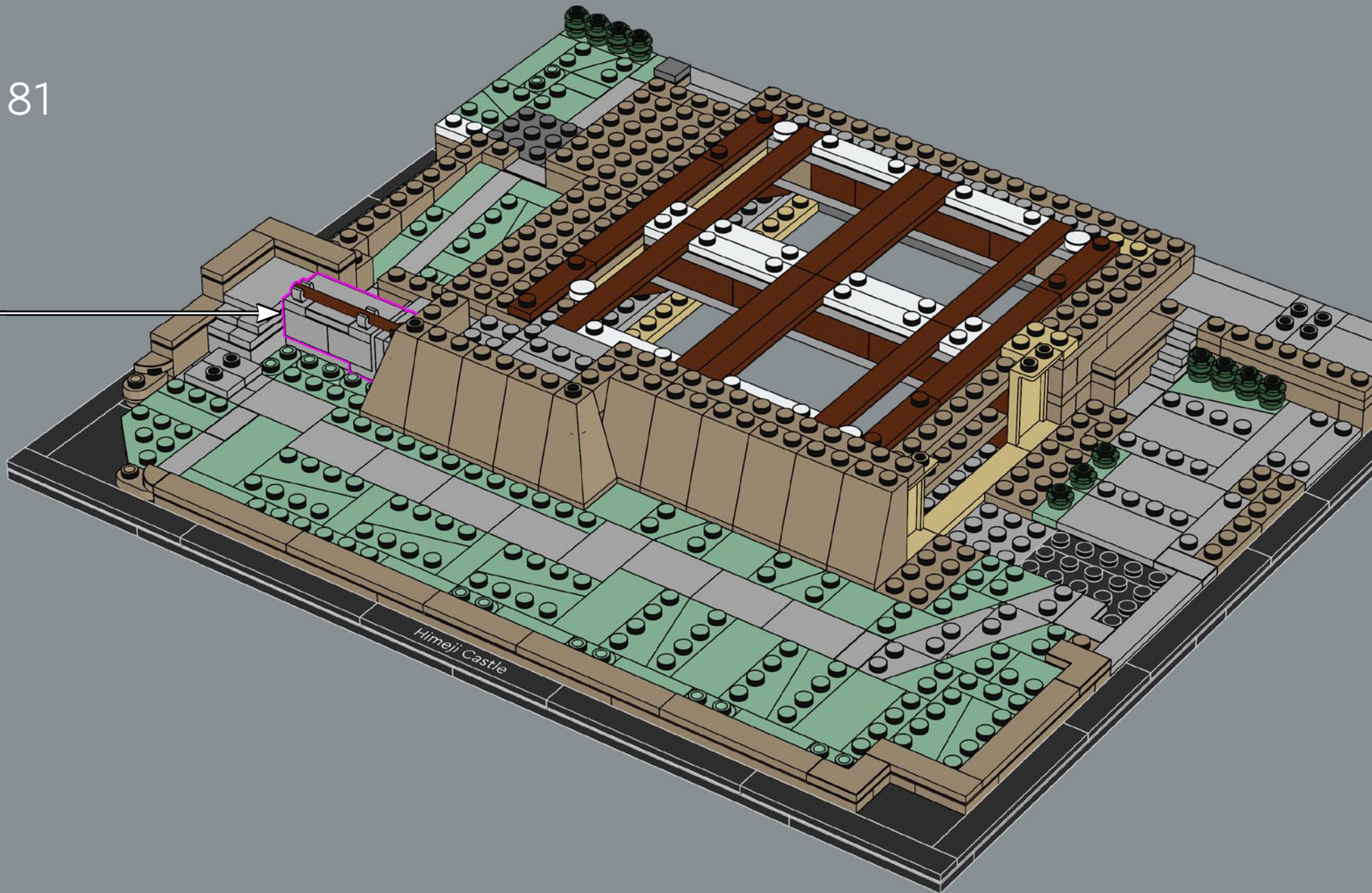

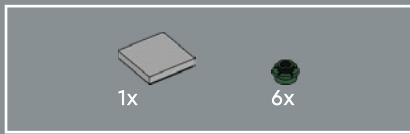

82

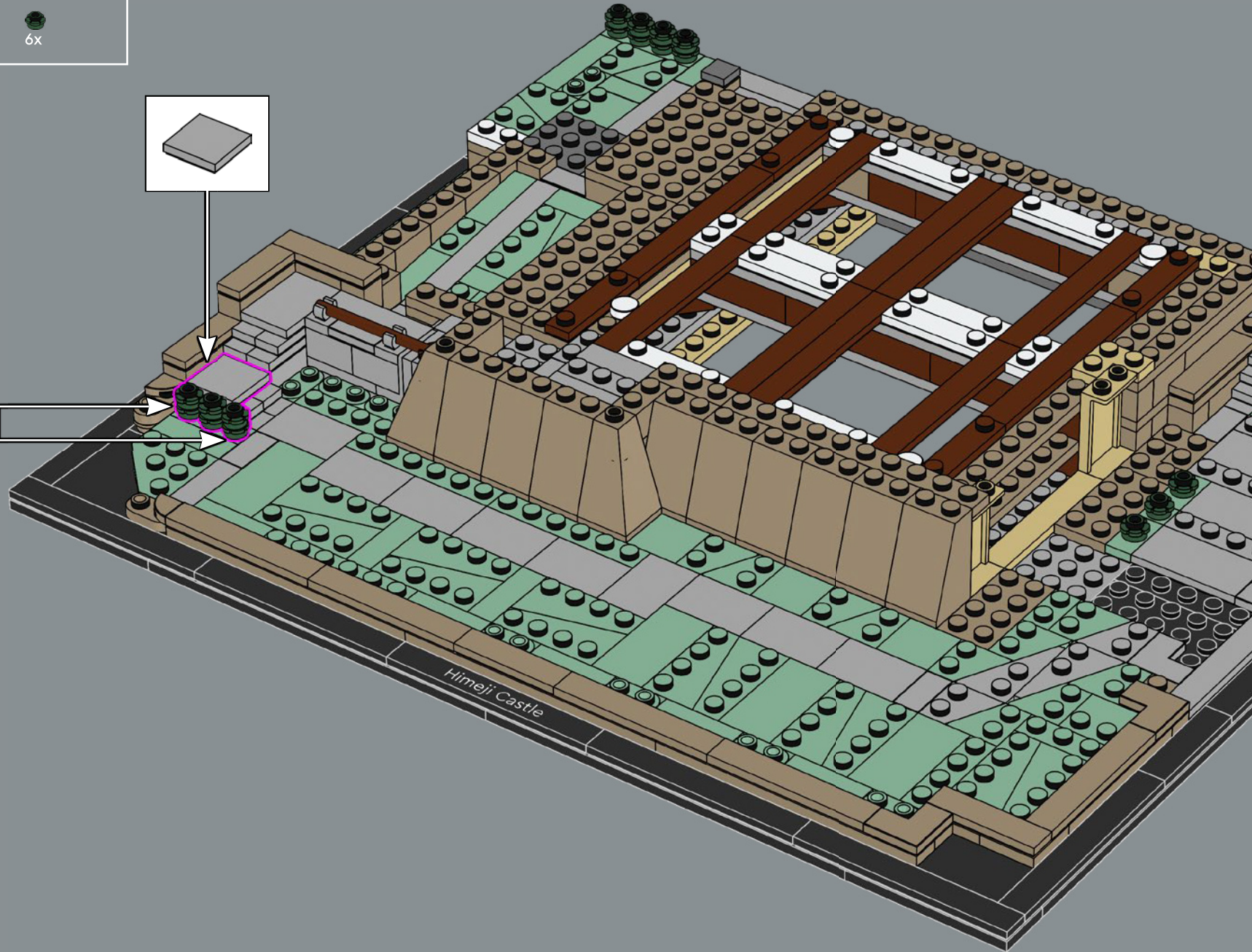
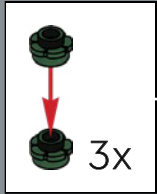
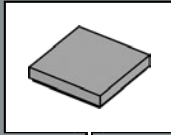

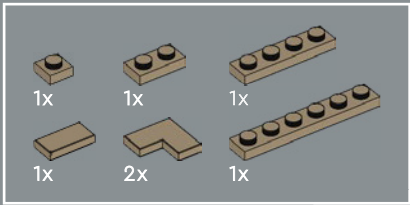

83

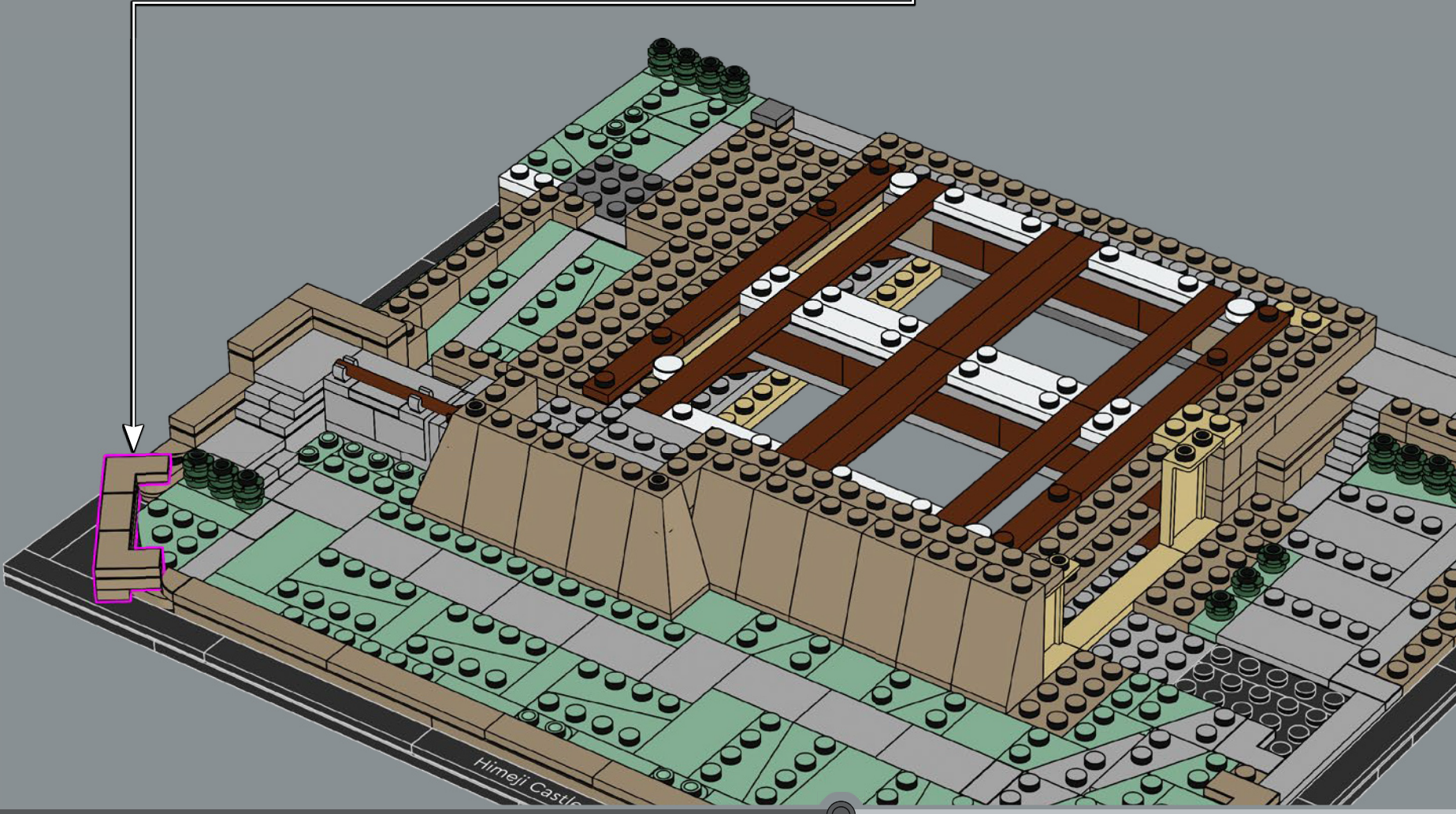
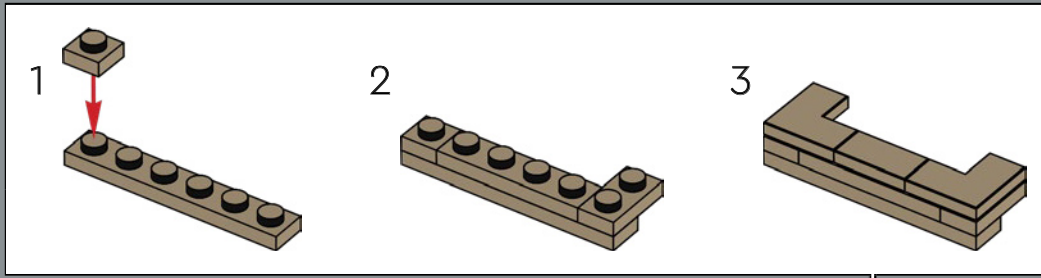

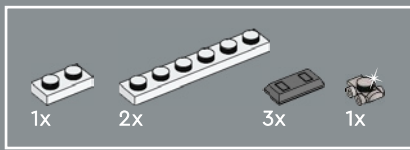

84

1

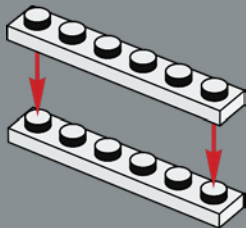

2

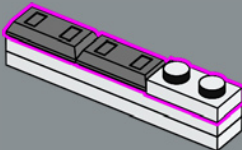

3

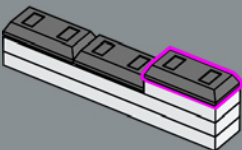

4



1:1

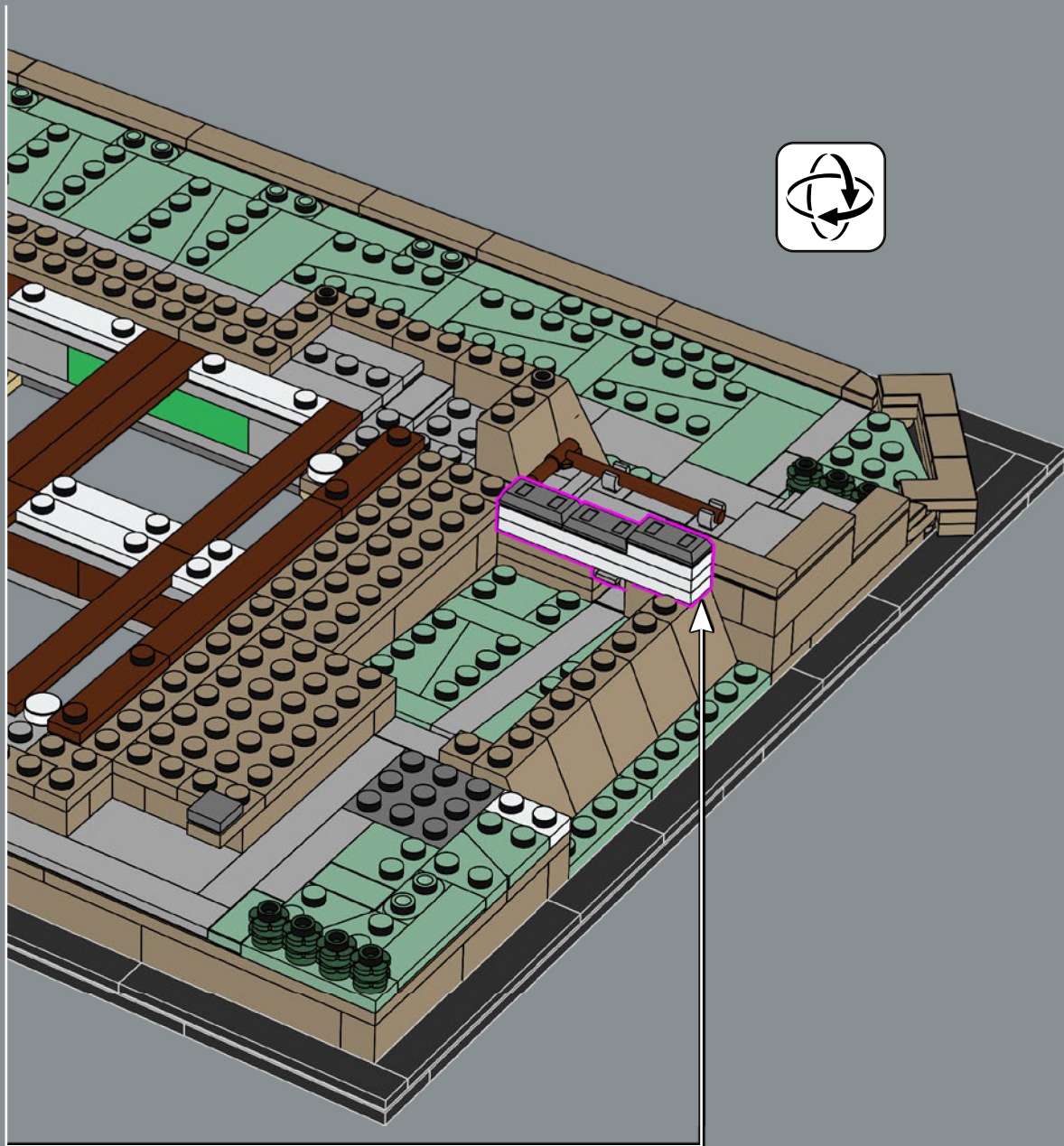
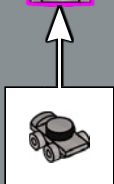

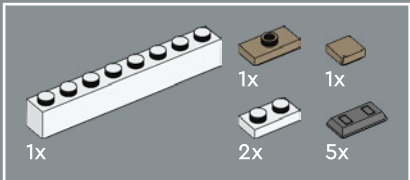

85

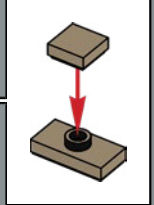
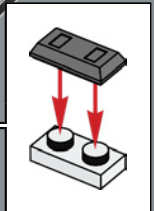
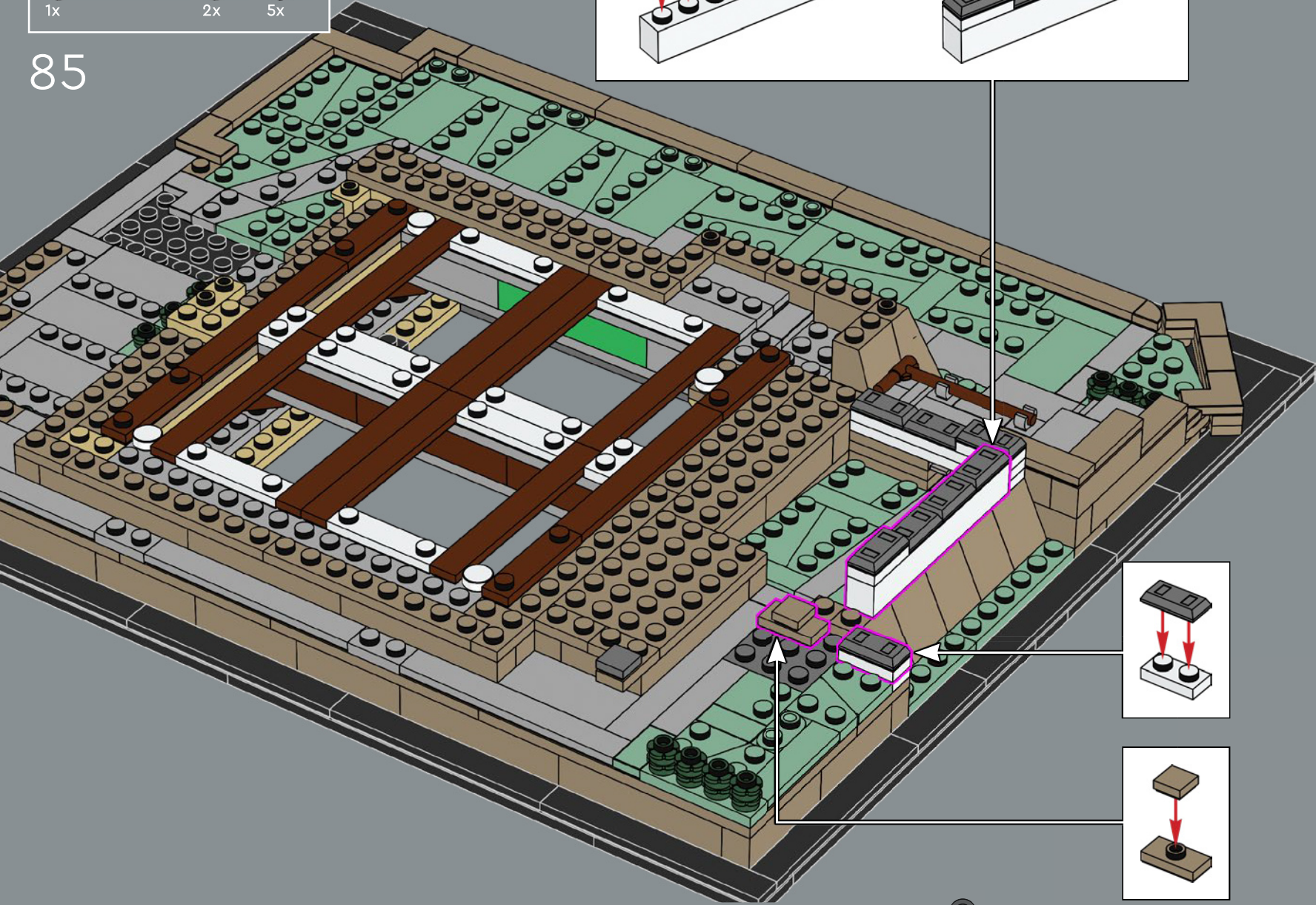
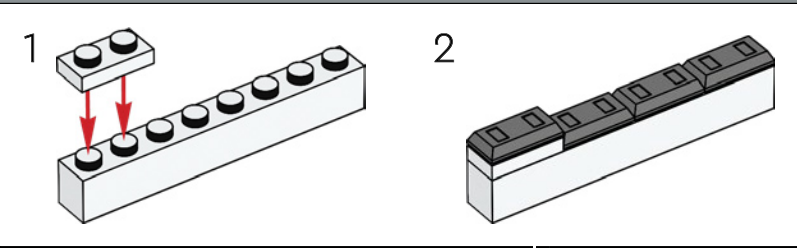

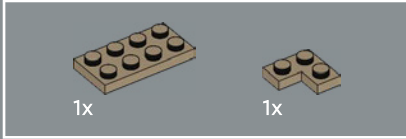
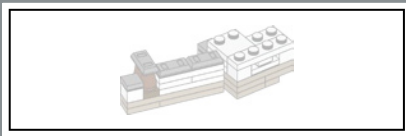

86

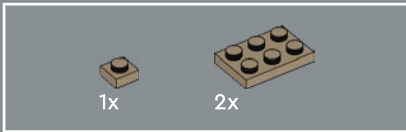
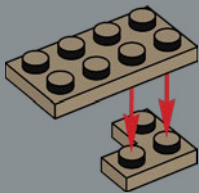

87

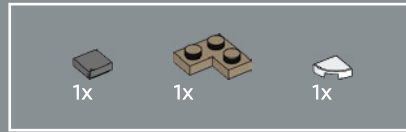
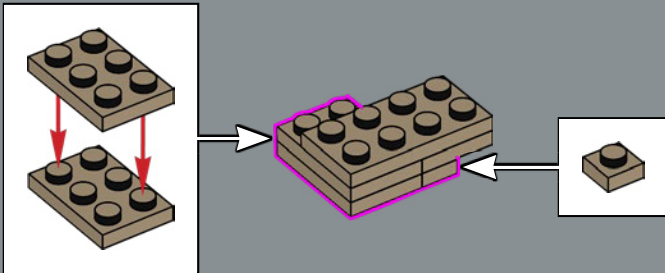

88

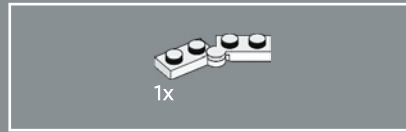
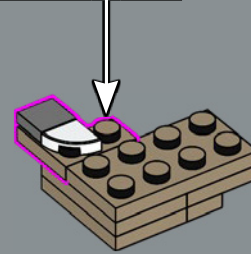
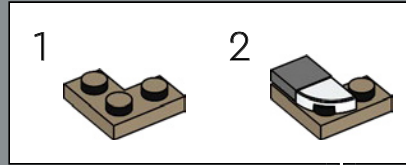

89

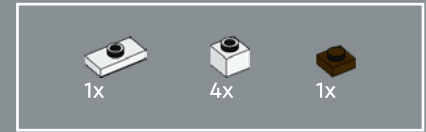
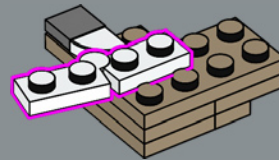

90

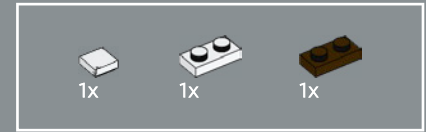
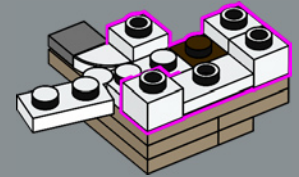

91

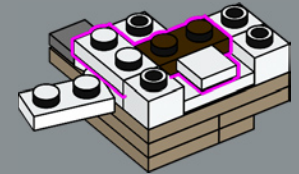

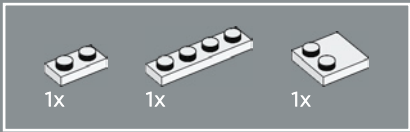

92

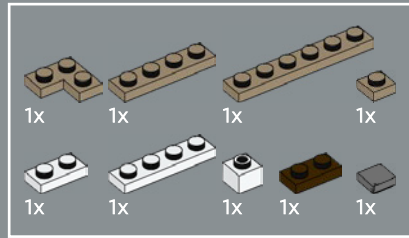
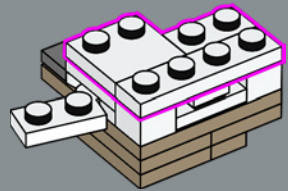

93

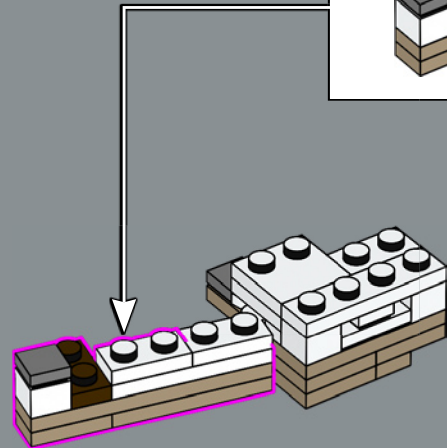
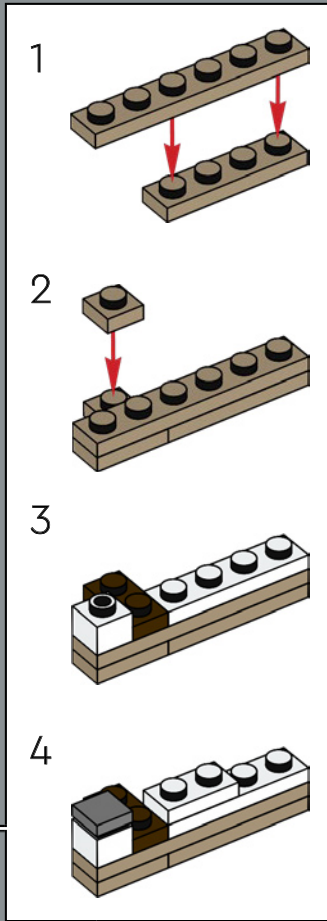

94

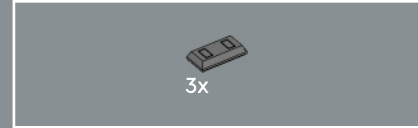
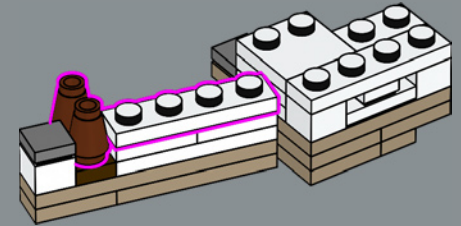

95

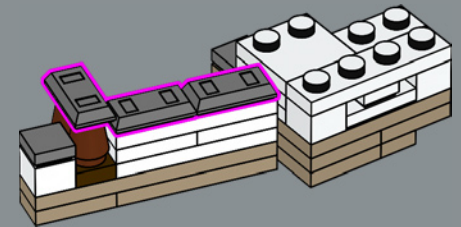

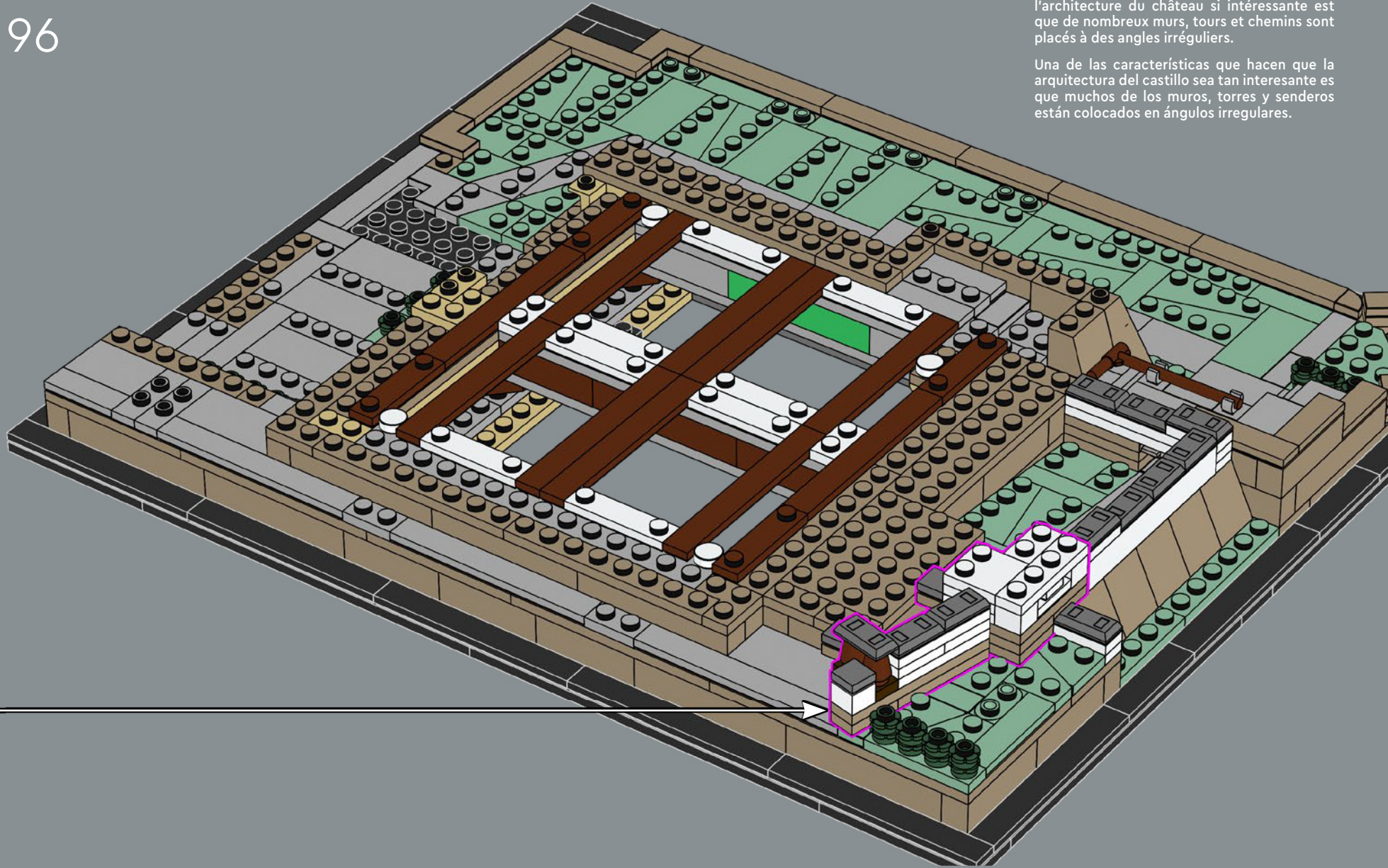

One of the features that make the castle's architecture so interesting is that many of the walls, towers and pathways are placed at irregular angles.

L'une des caractéristiques qui rendent l'architecture du château si intéressante est que de nombreux murs, tours et chemins sont placés à des angles irréguliers.

Una de las características que hacen que la arquitectura del castillo sea tan interesante es que muchos de los muros, torres y senderos están colocados en ángulos irregulares.

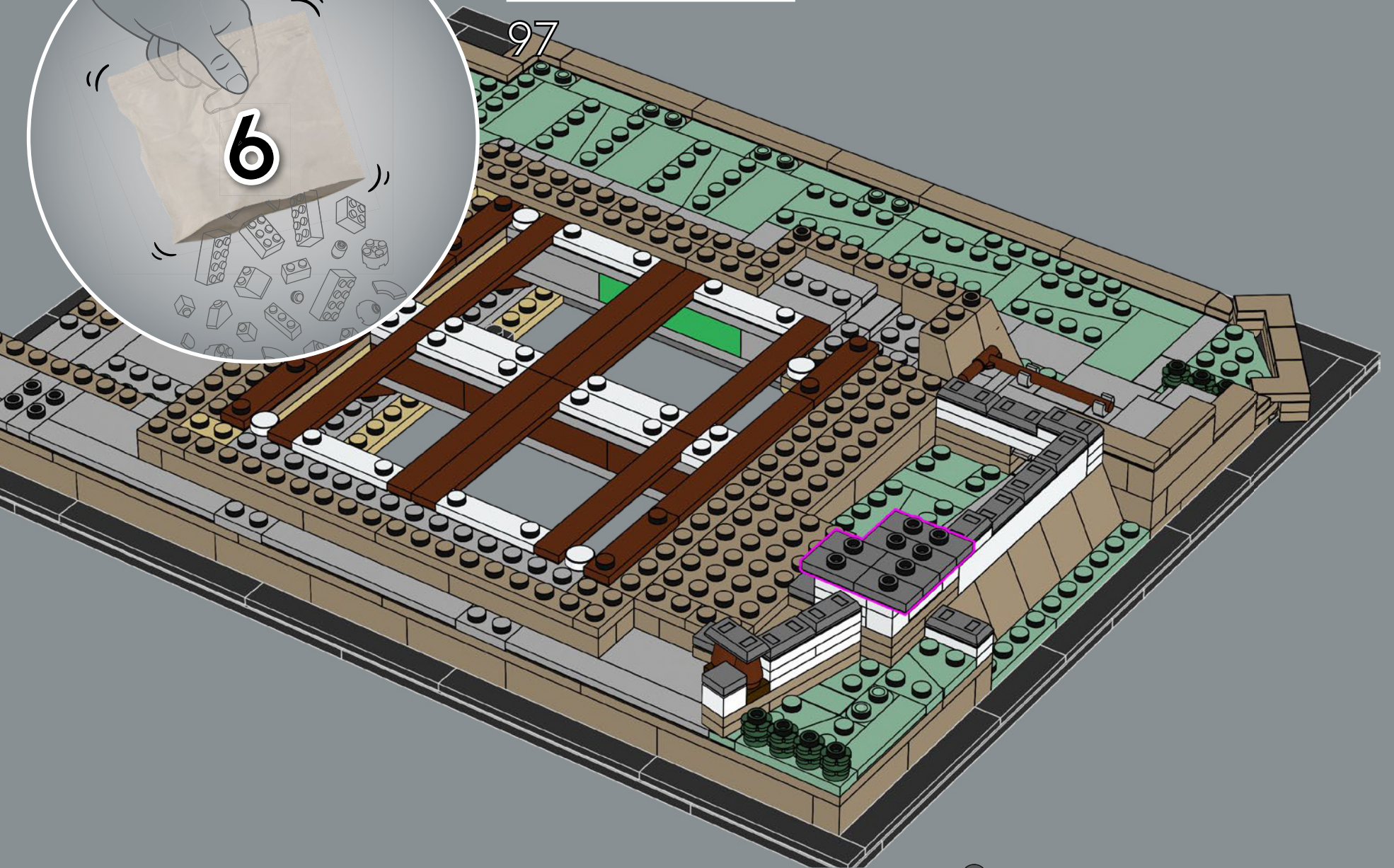
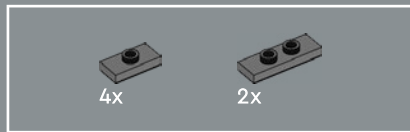

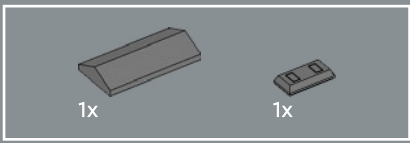

98

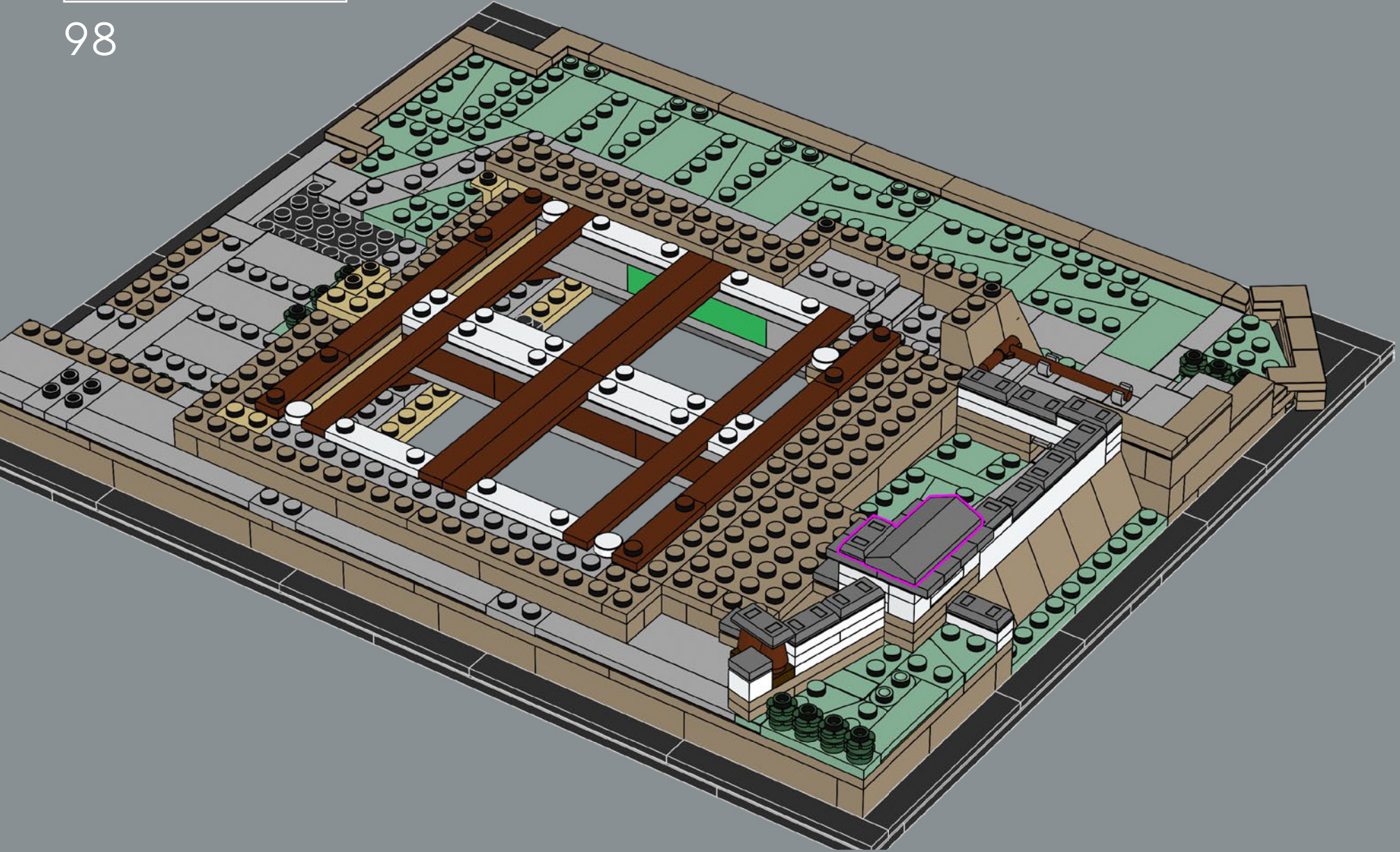

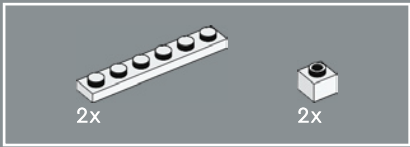

99

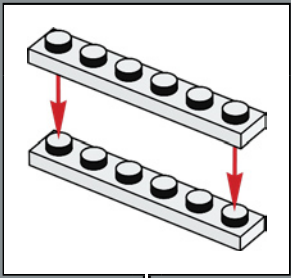

Himeji Castle



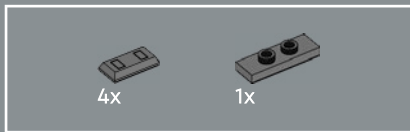

100

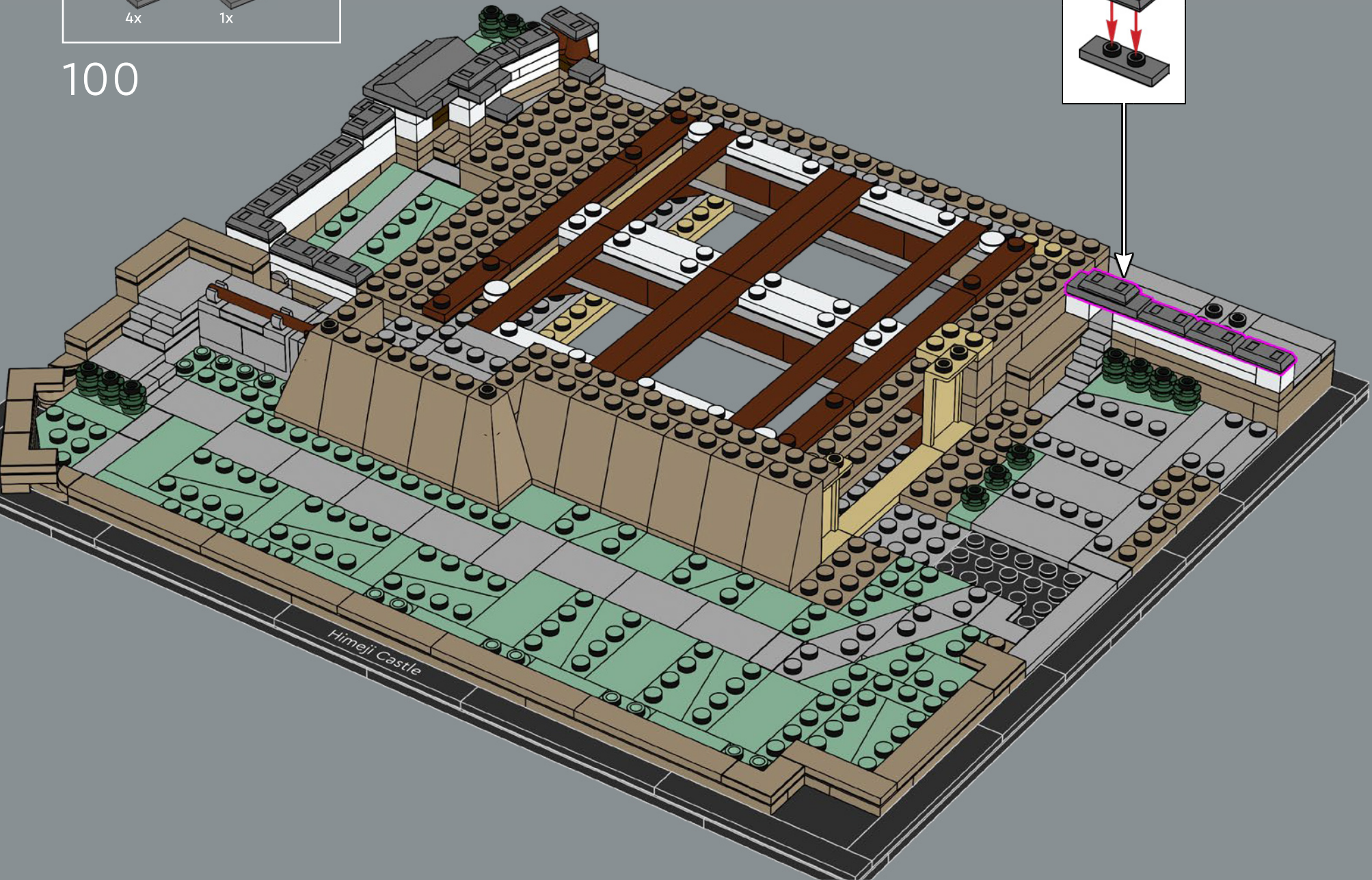
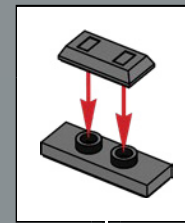

Himeji Castle

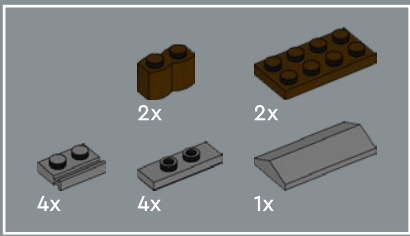

101

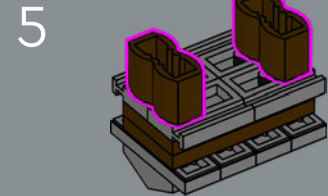
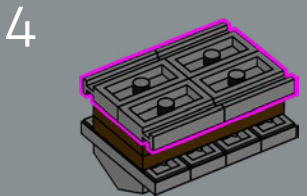
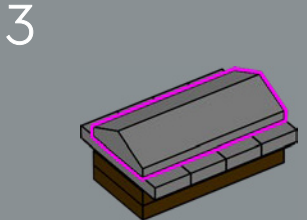
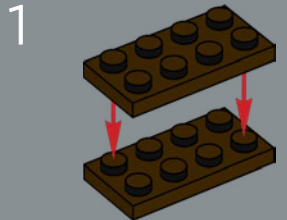

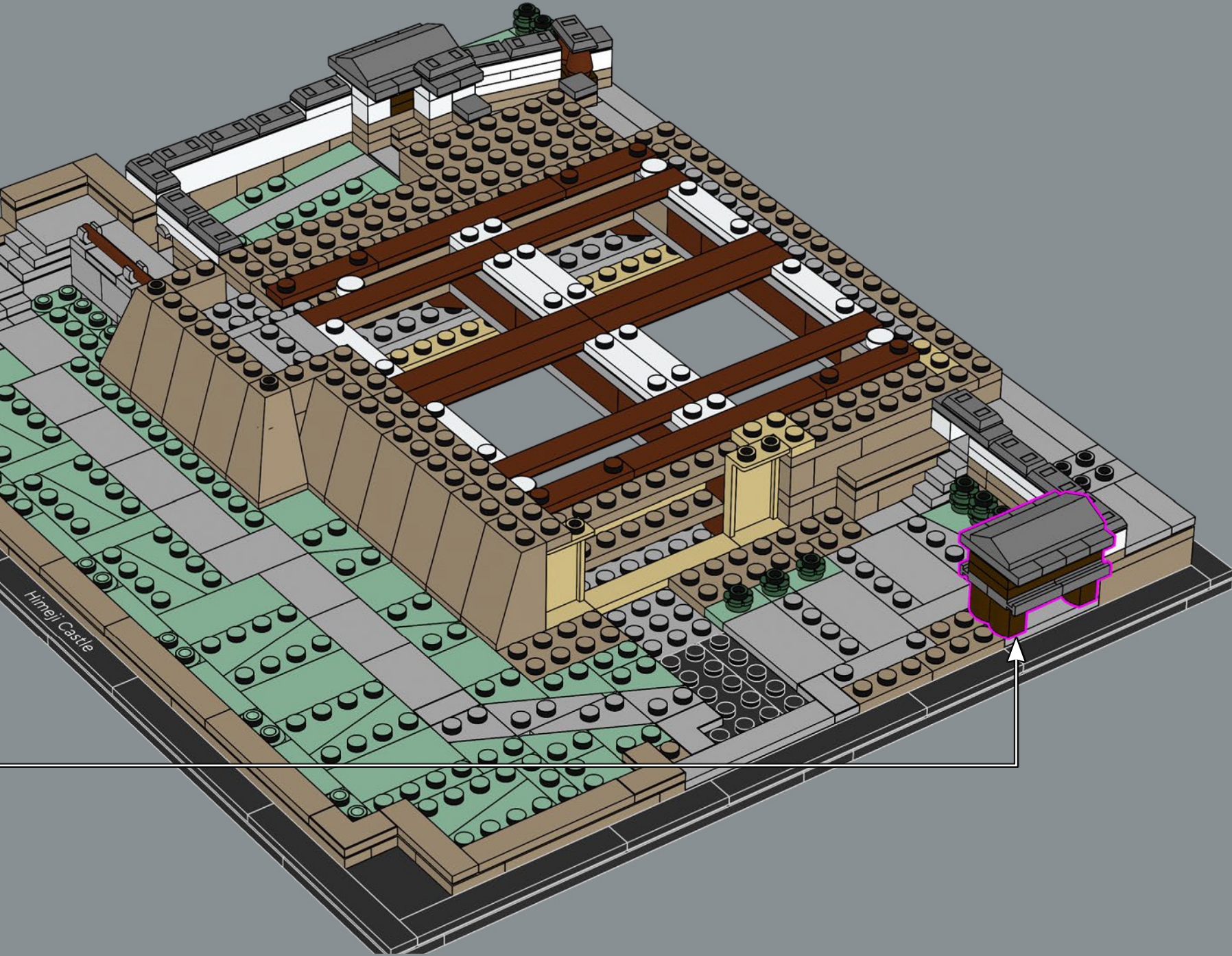

Himeji Castle

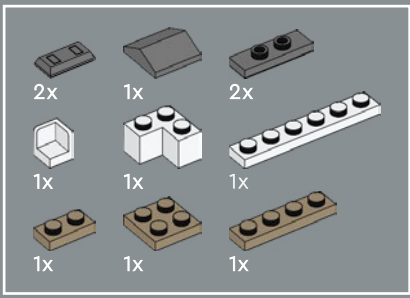

102

1

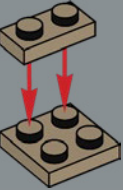

2

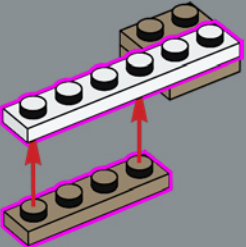

3

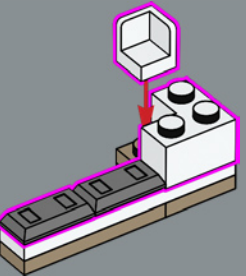

4

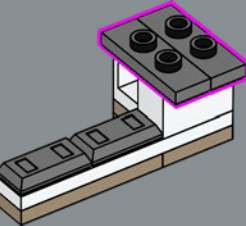

5

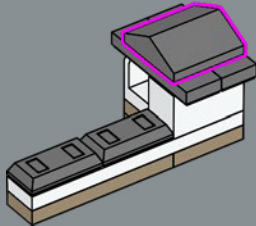

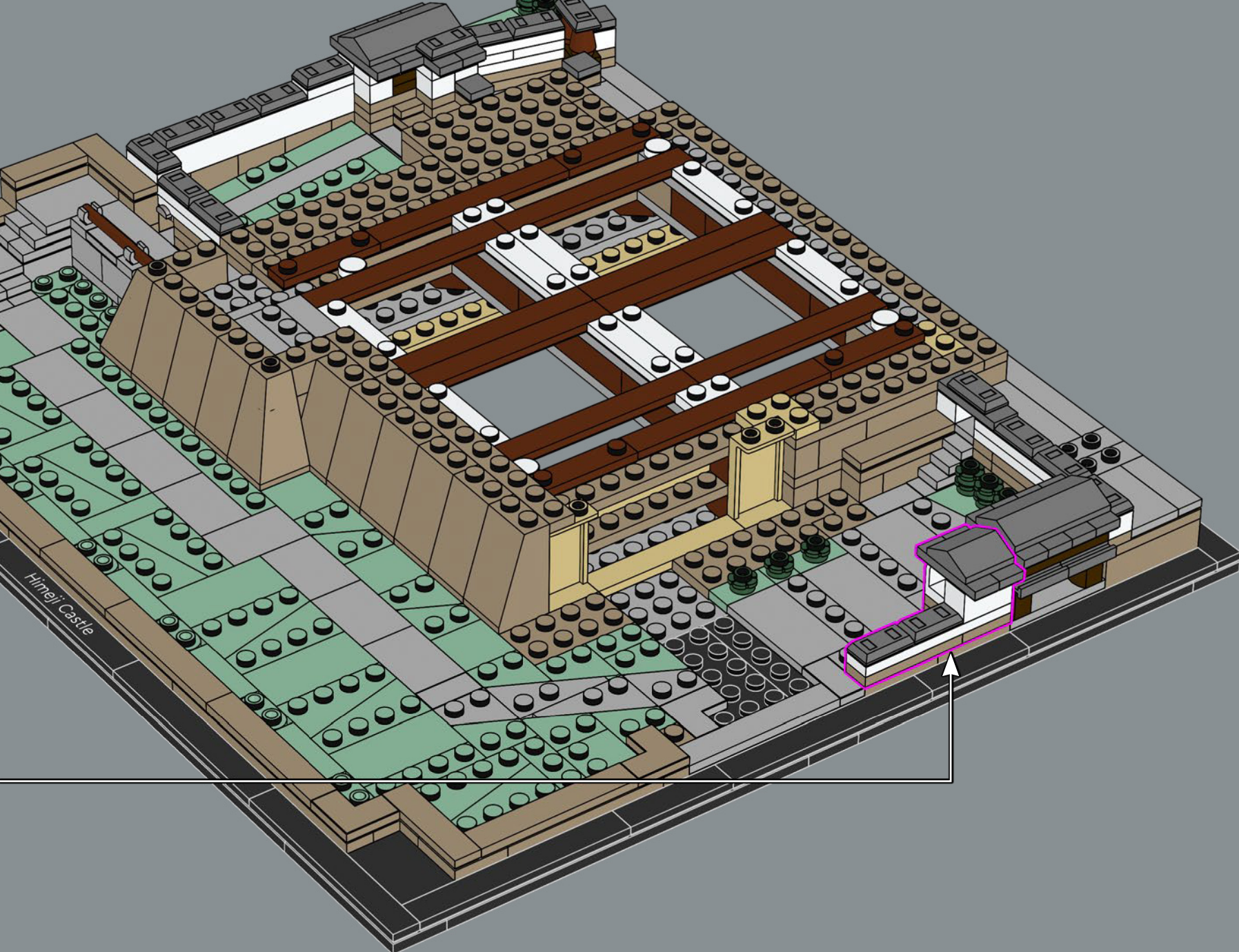

Himeji Castle

		
1x	2x	1x

103

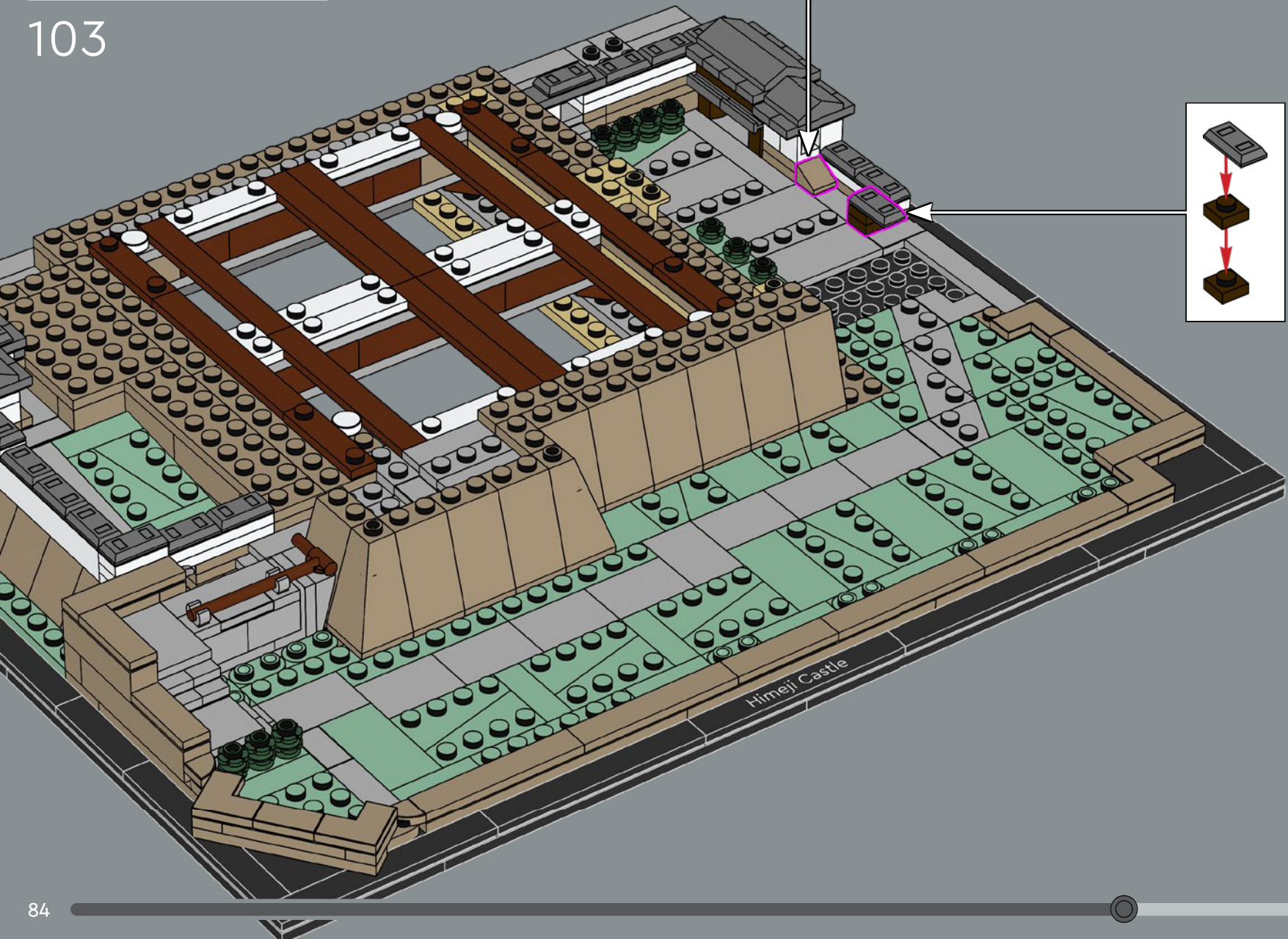
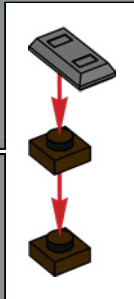

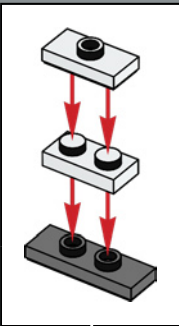
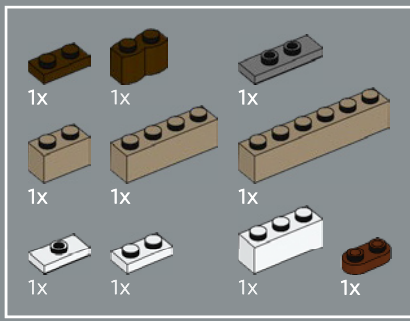

104

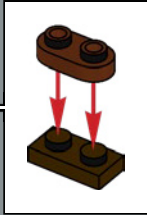
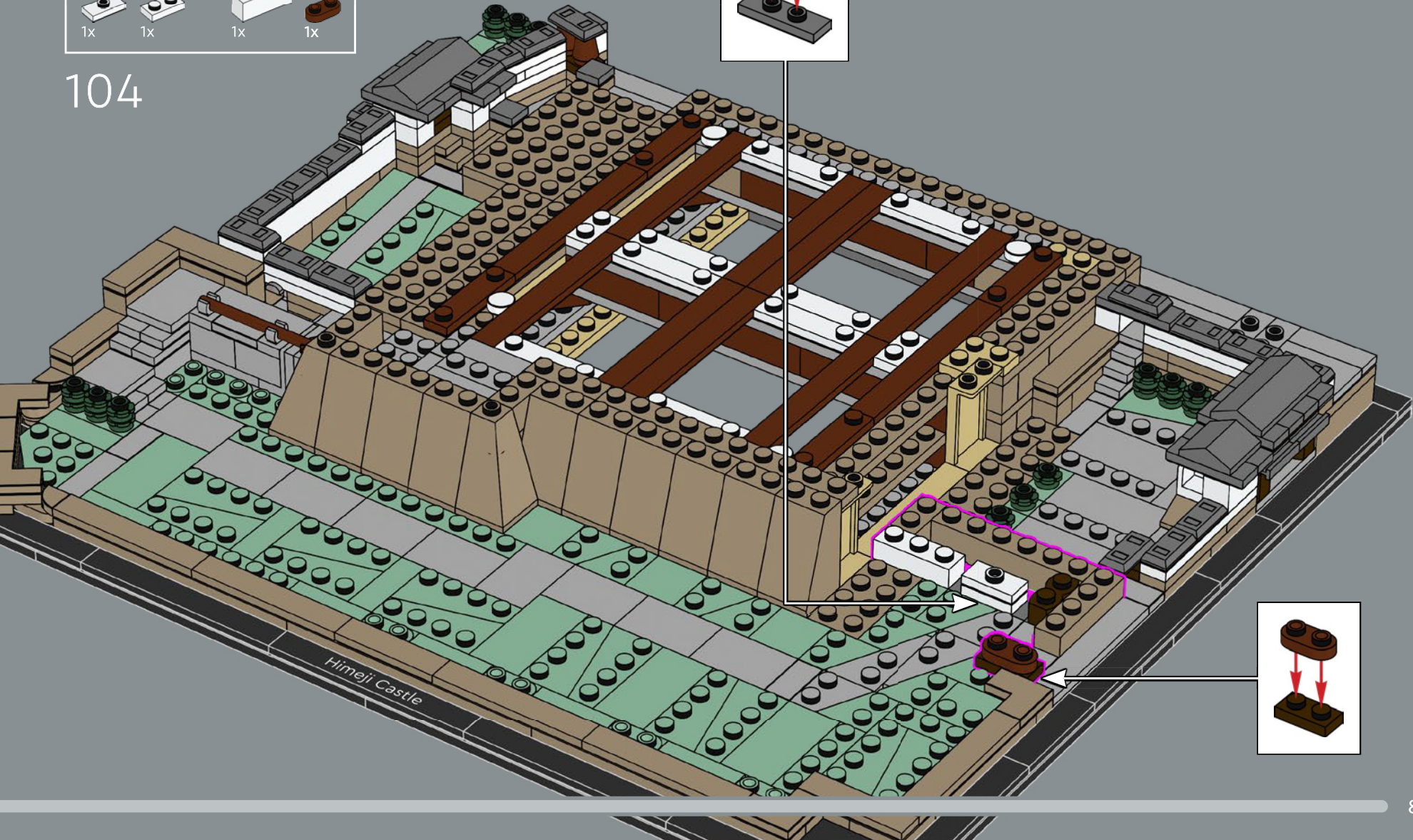

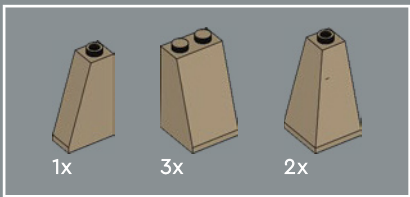

105

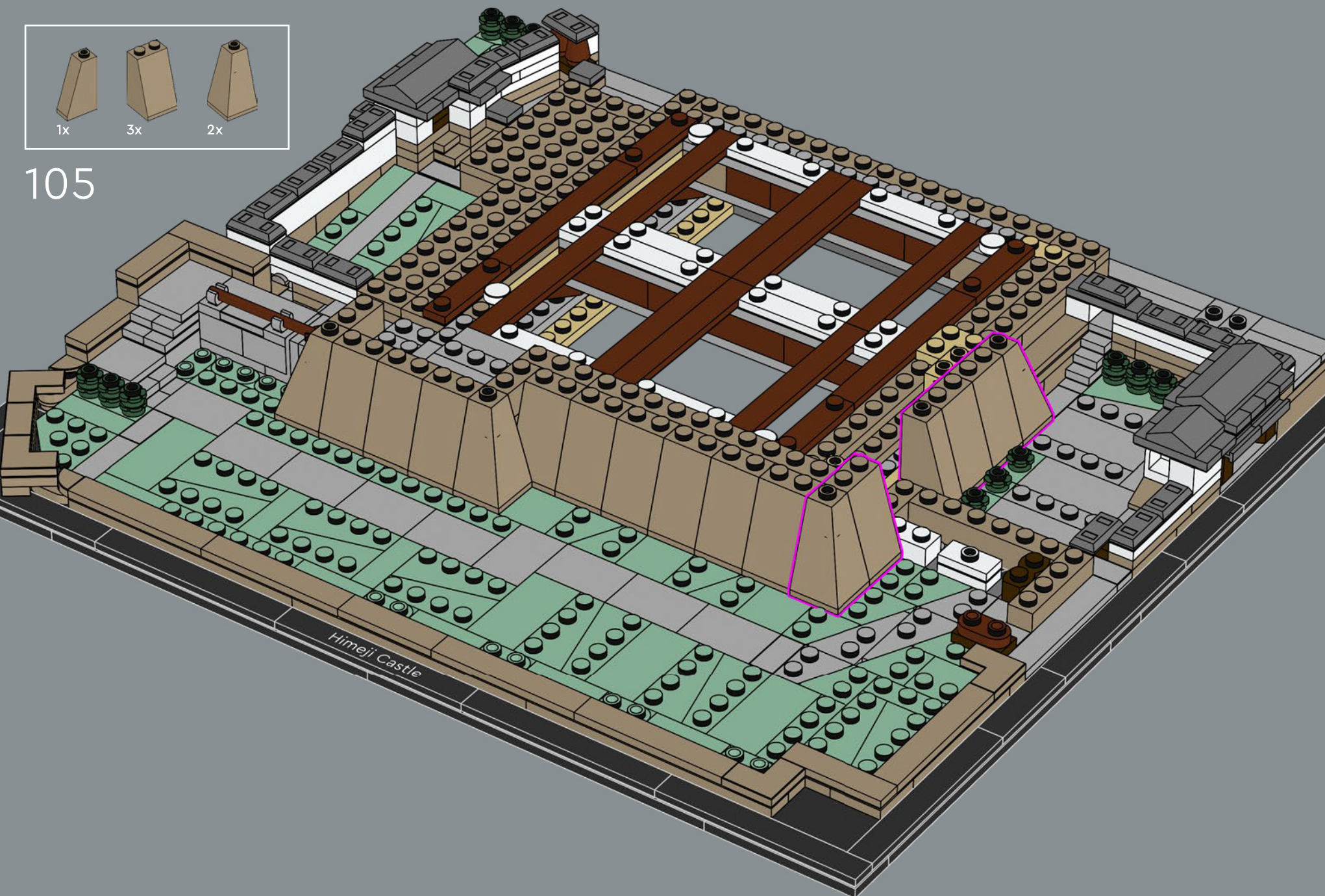

Himeji Castle



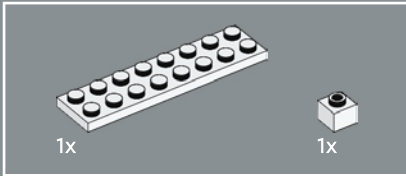
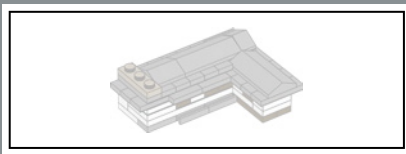

106

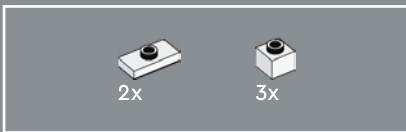
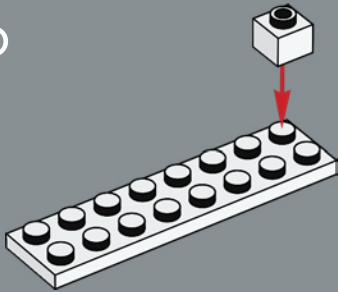

107

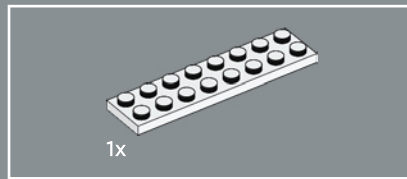
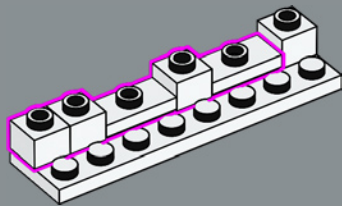

108

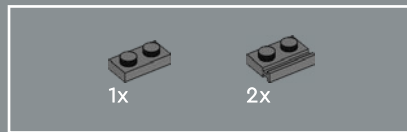
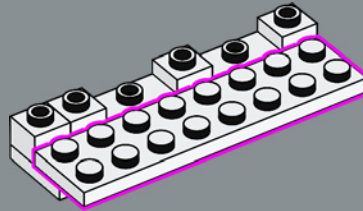

109

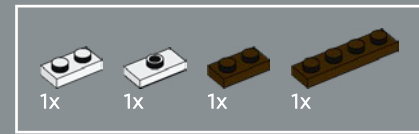
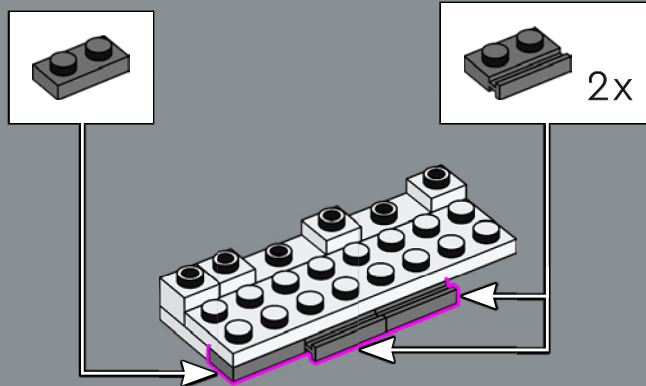

110

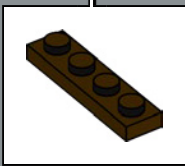
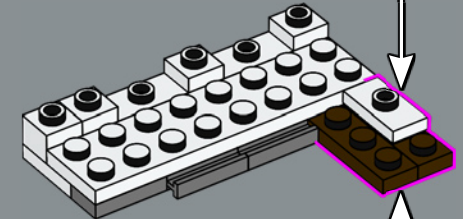
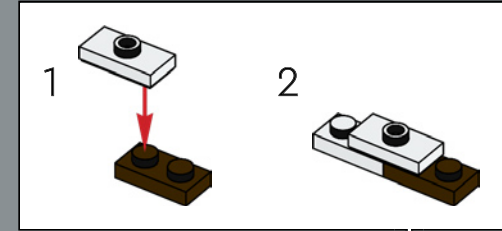

111

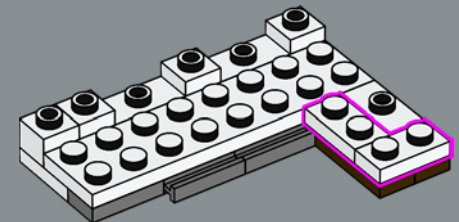

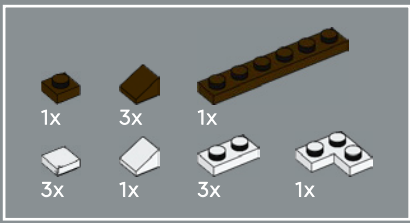

112

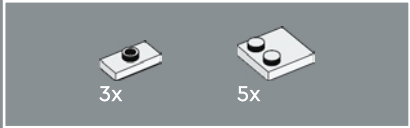
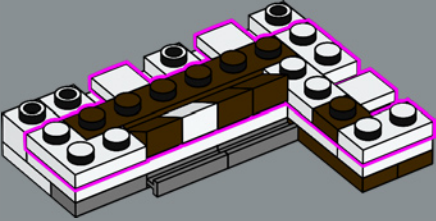

113

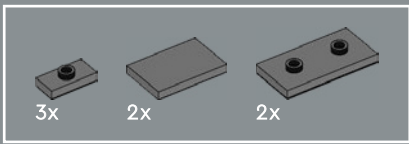
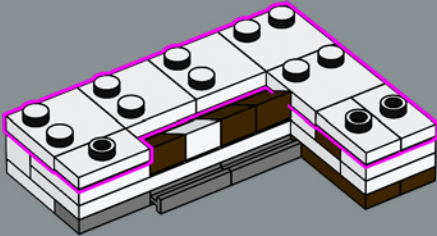

114

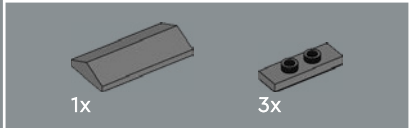
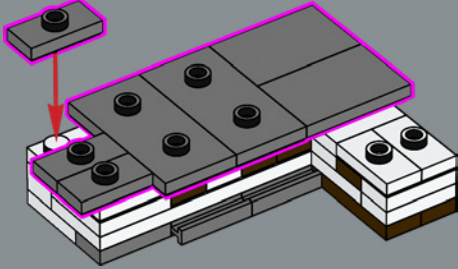

115

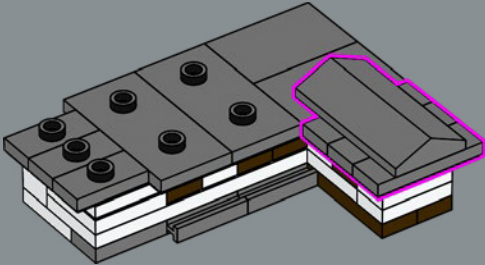
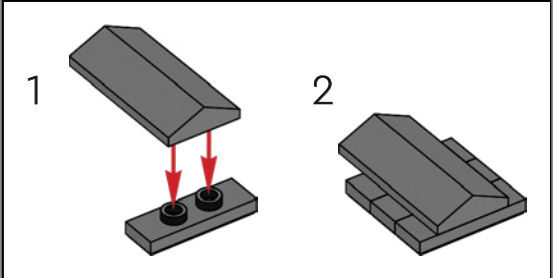

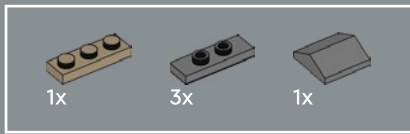

116

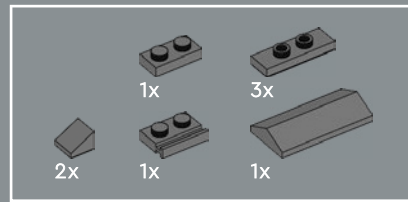
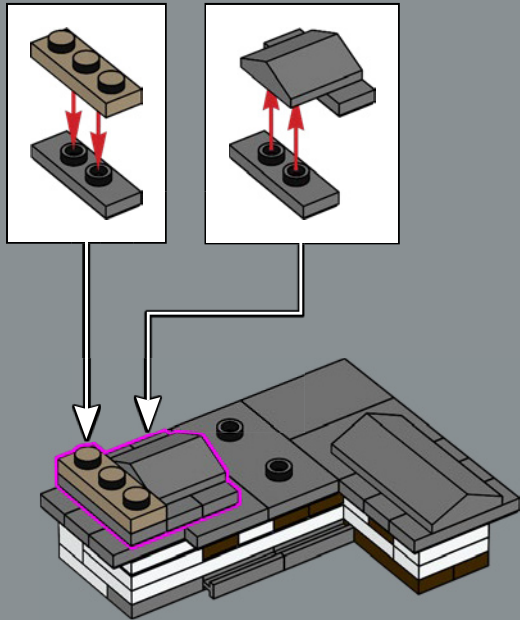

117

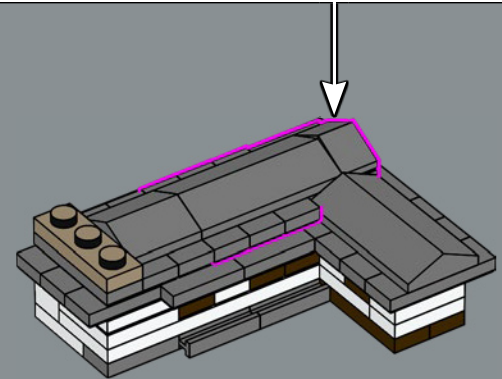
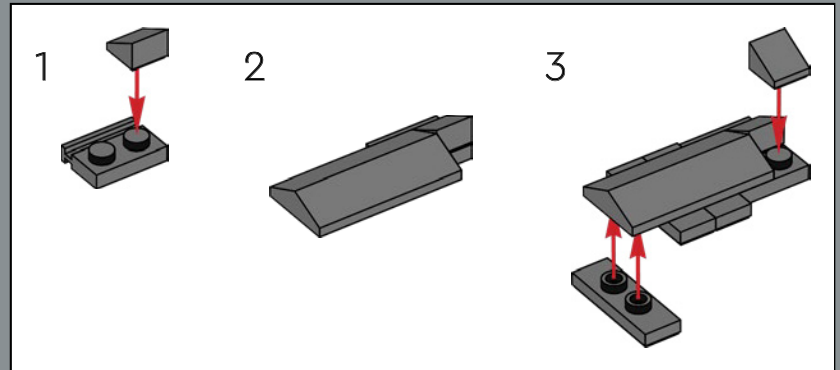

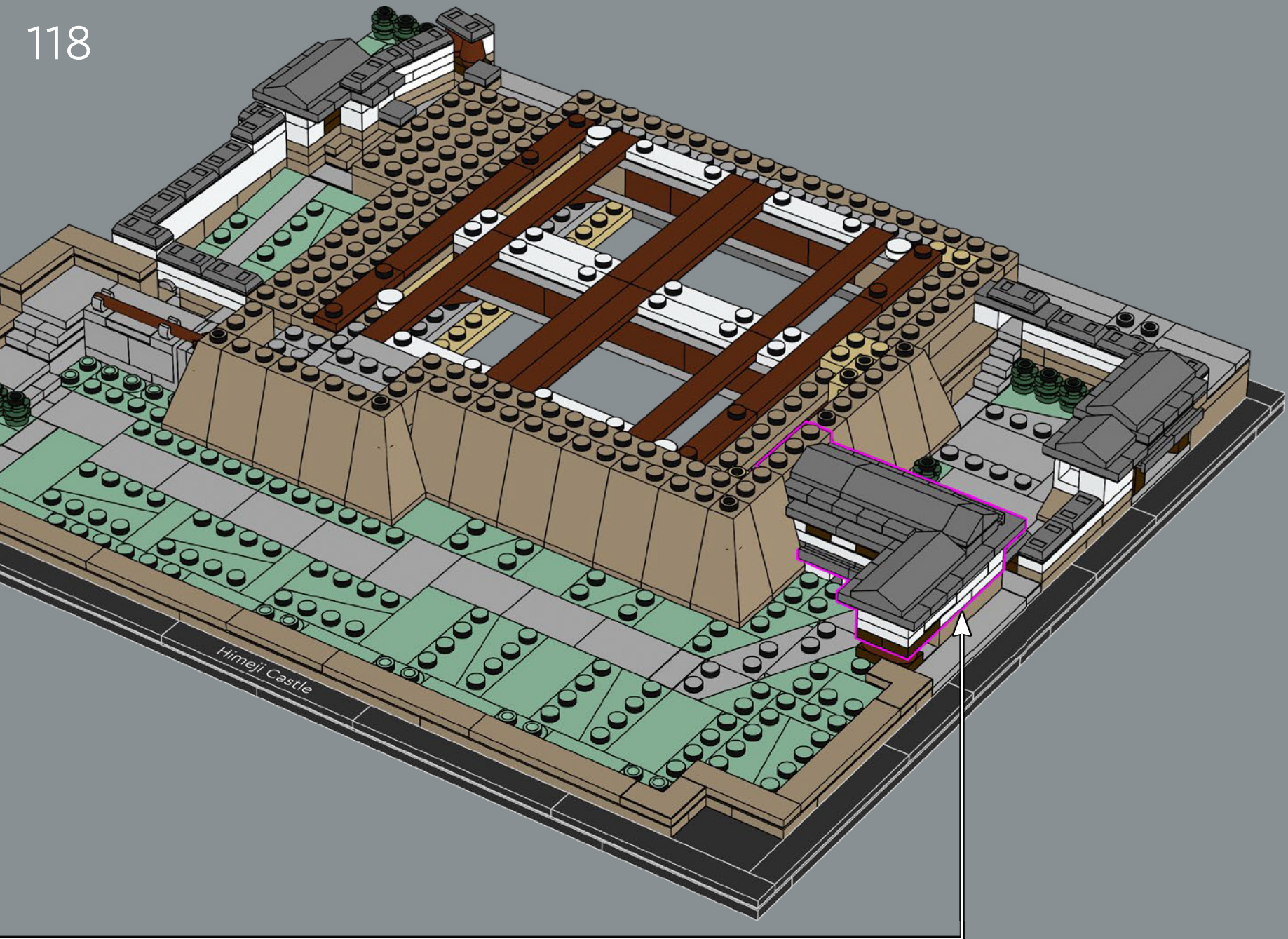

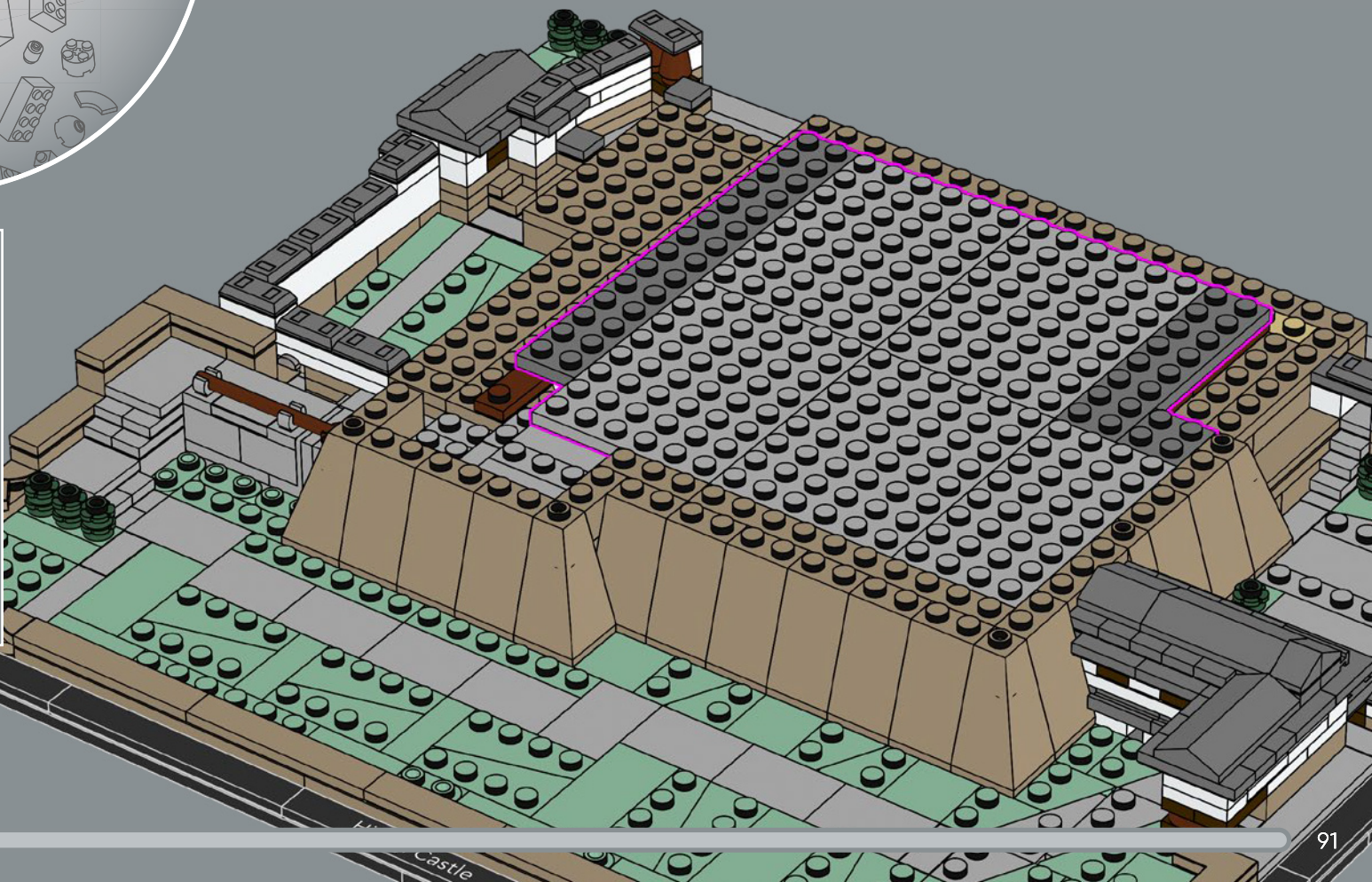
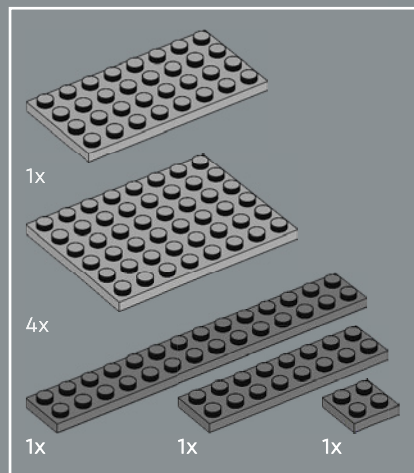

119

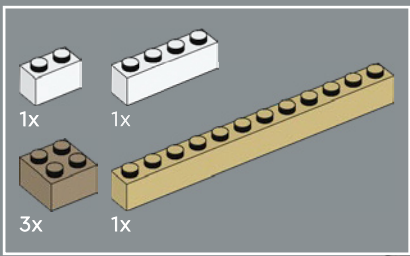

120

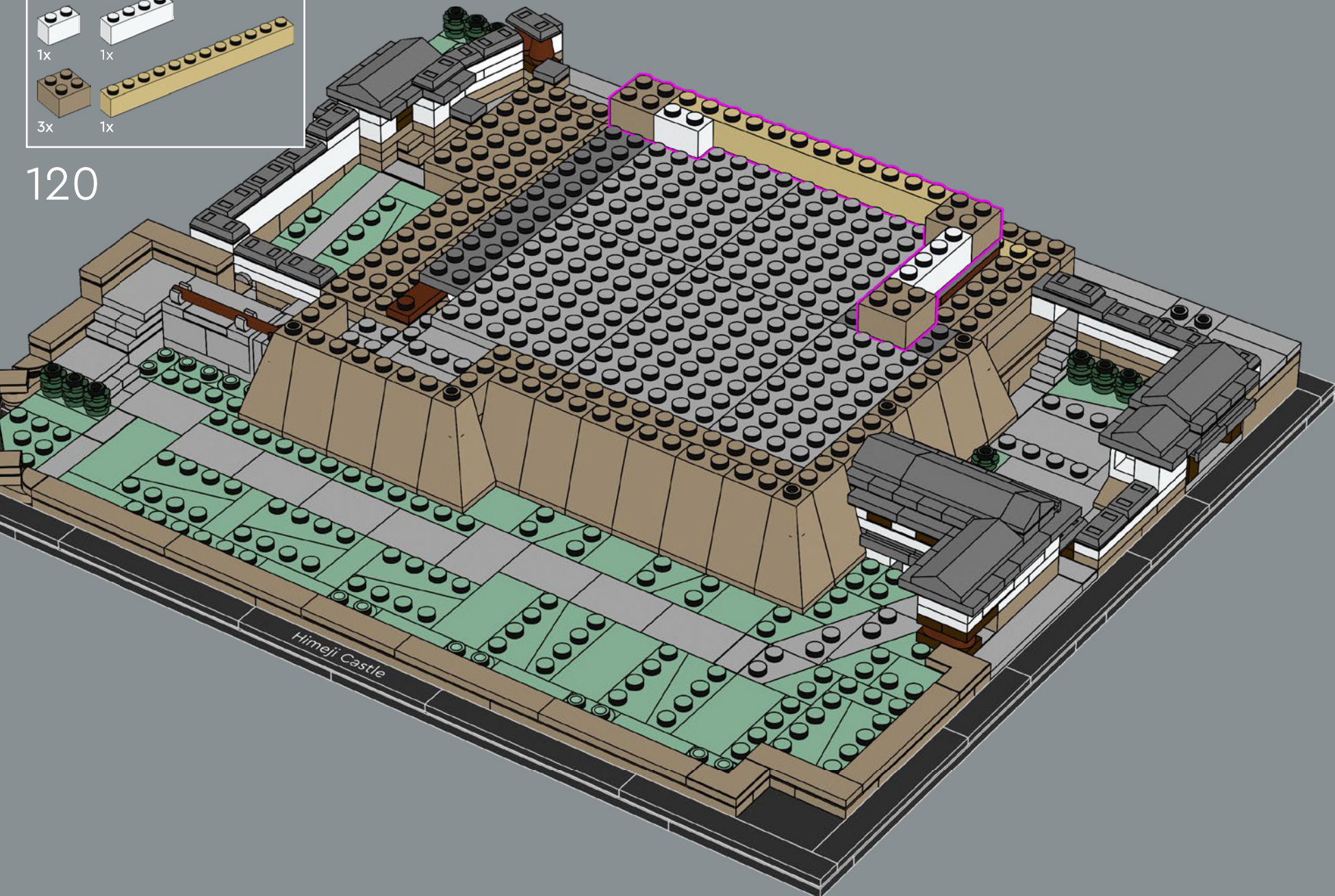

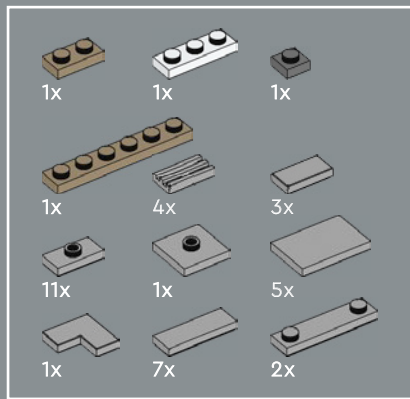

121

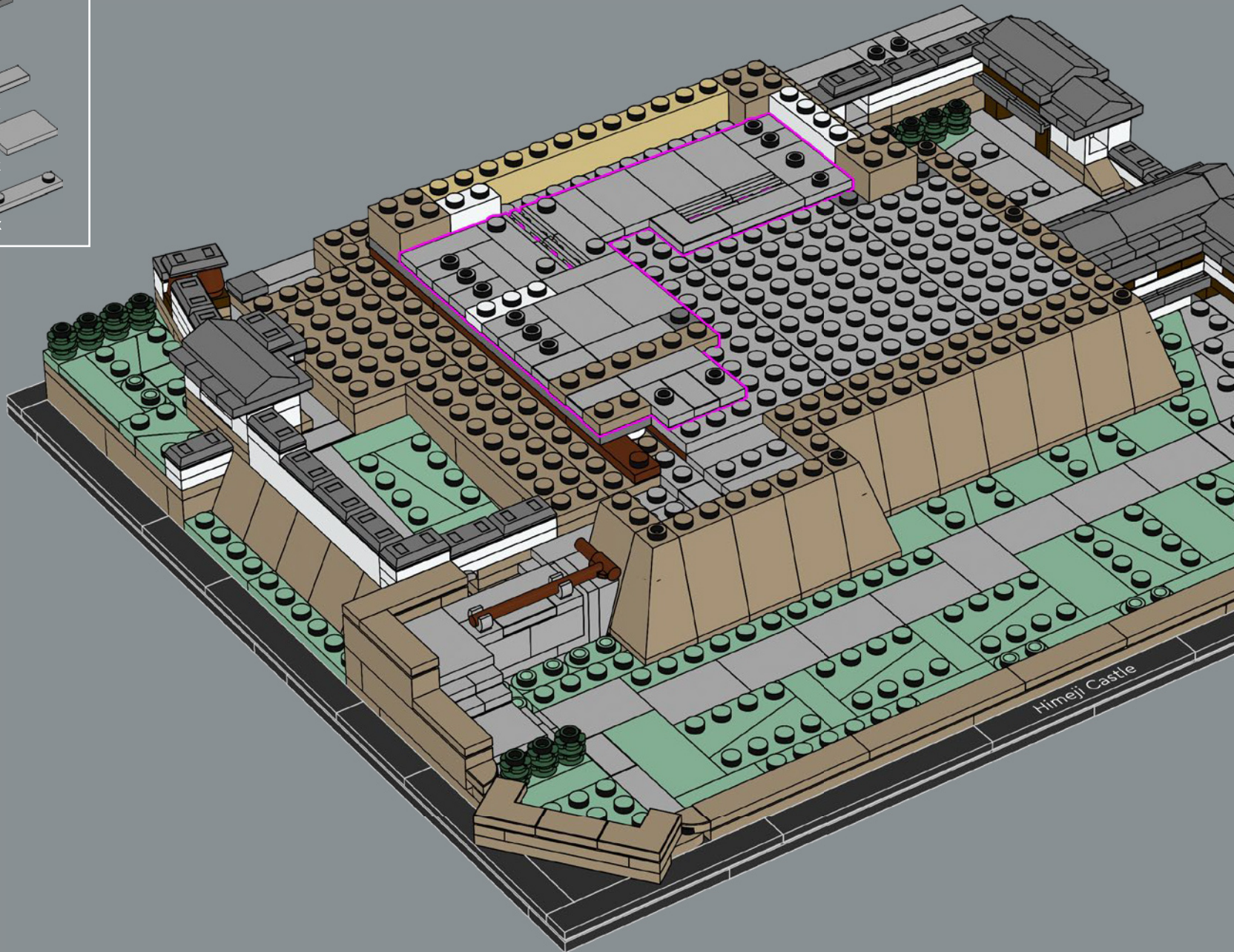

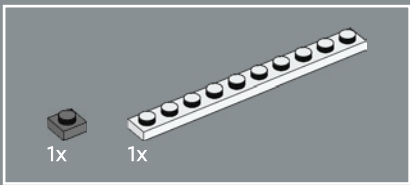

122

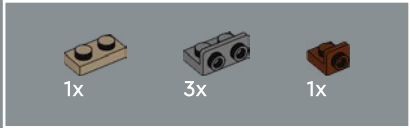
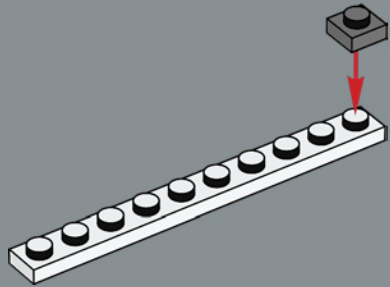

123

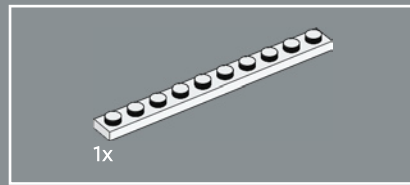
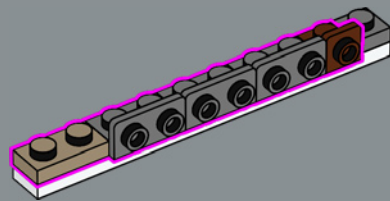

124

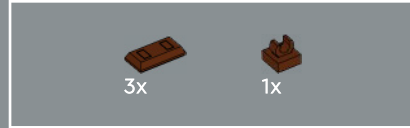
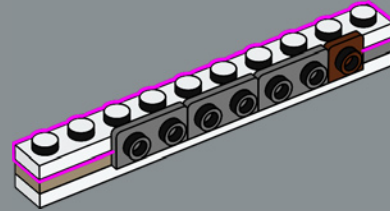

125

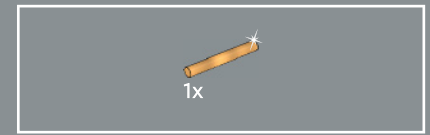
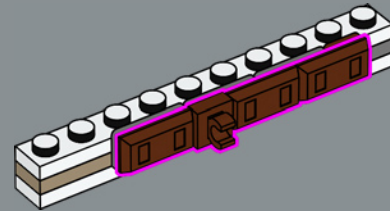

126

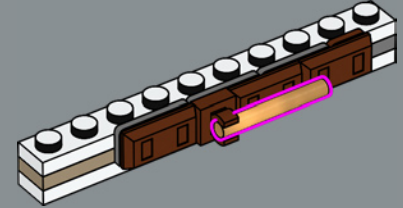

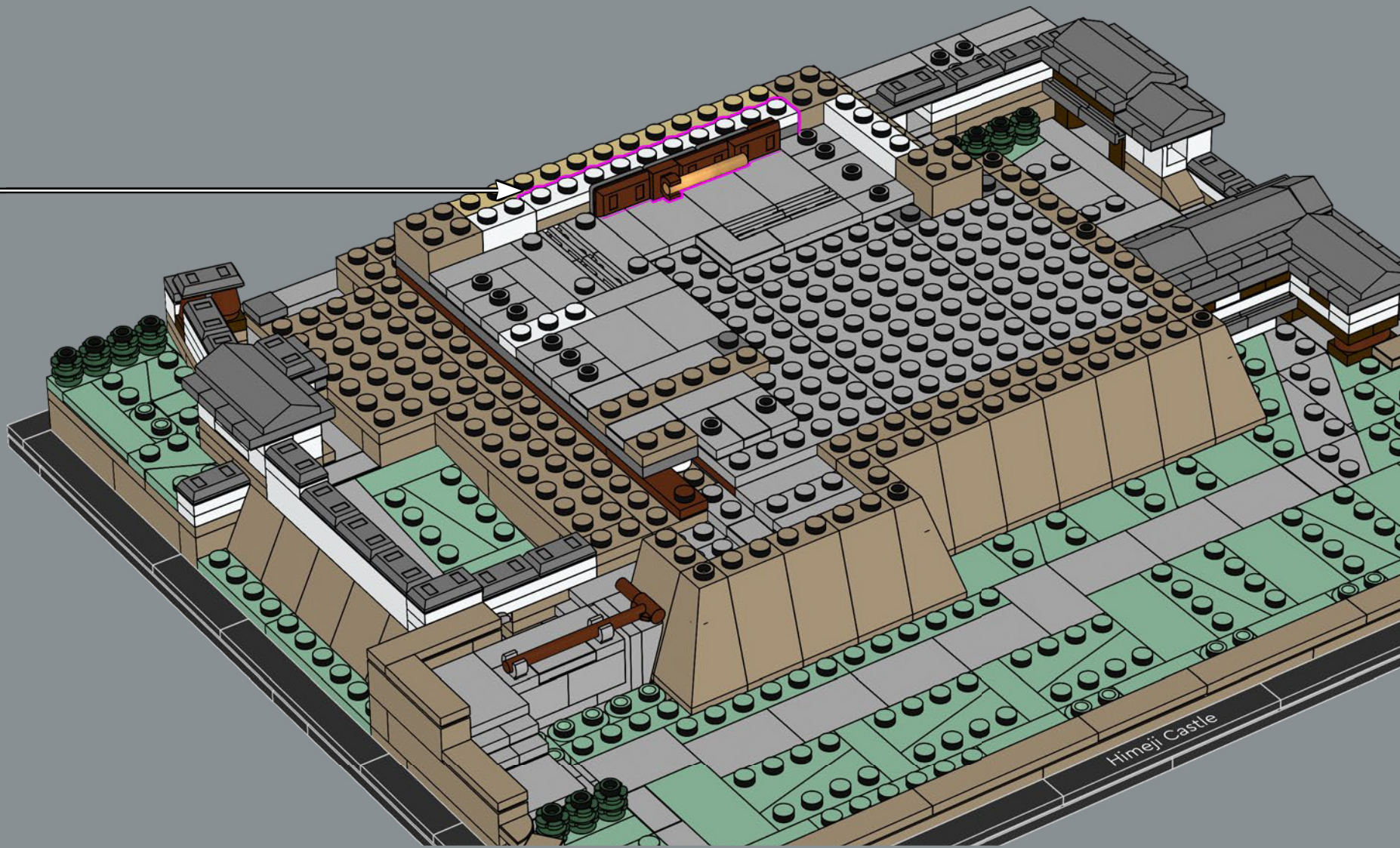

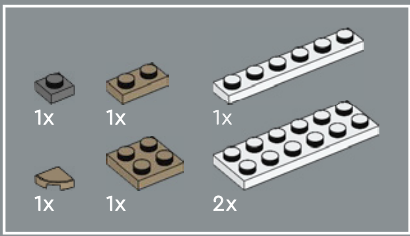

128

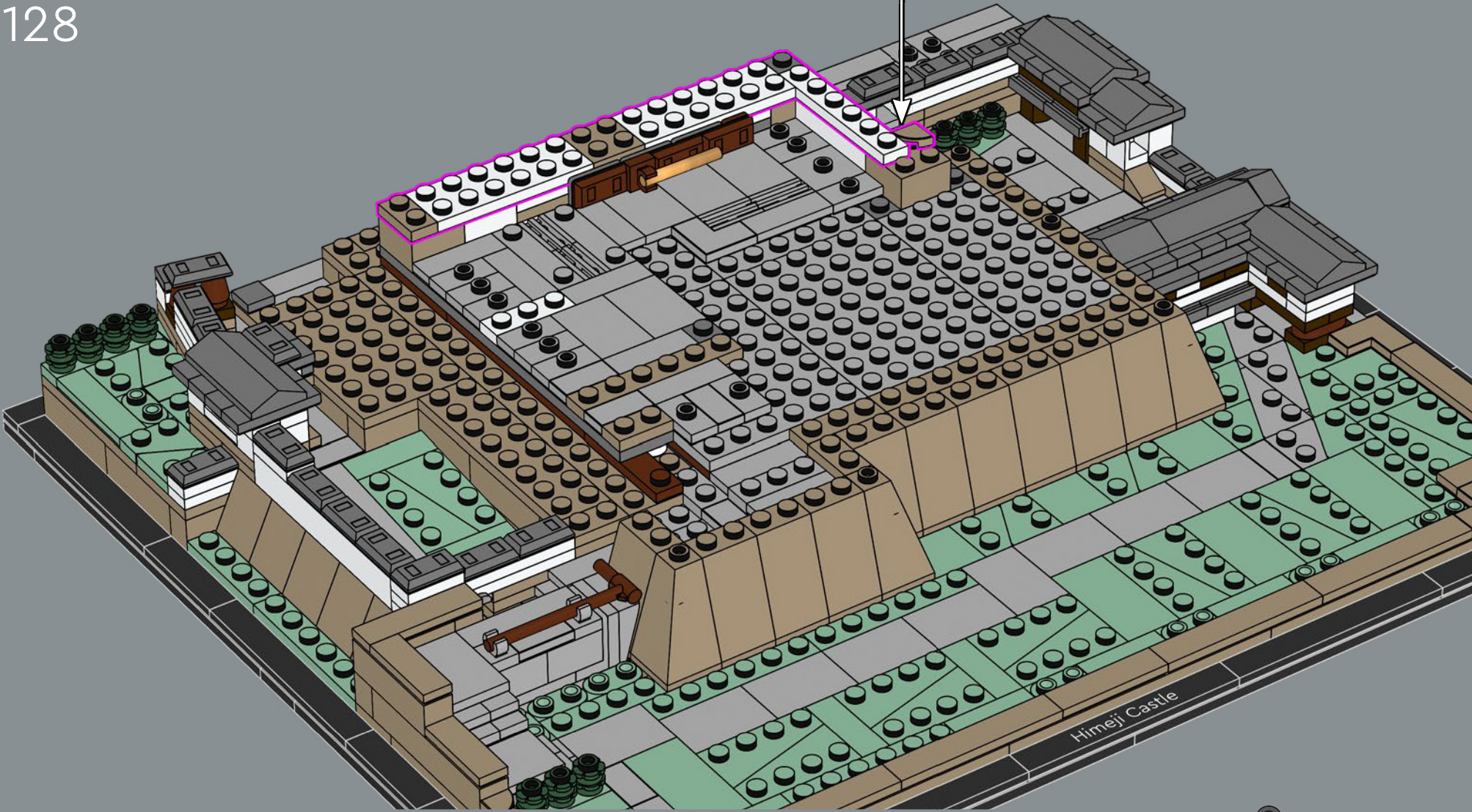

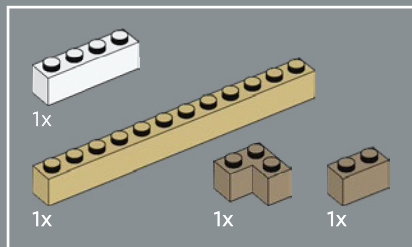

129

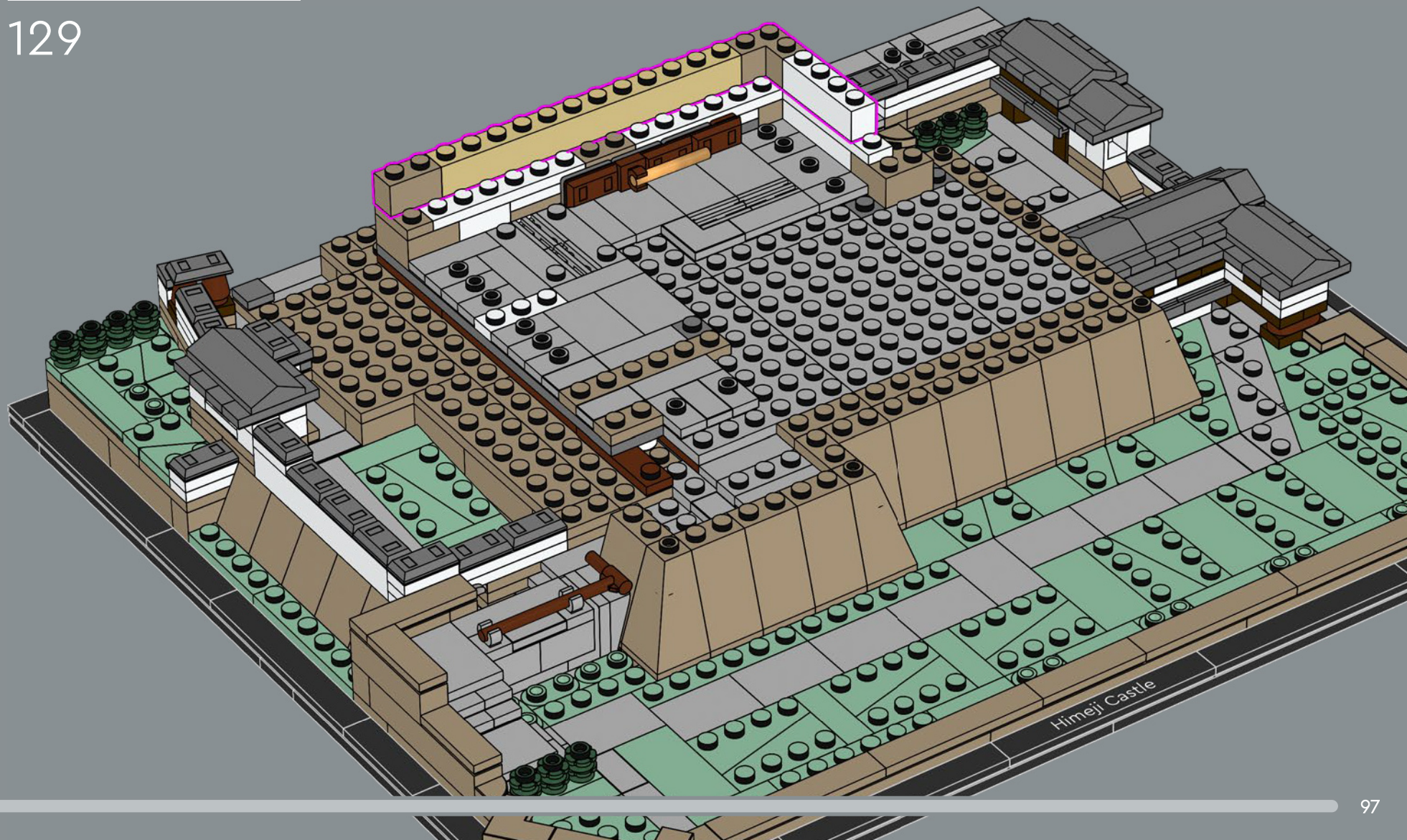

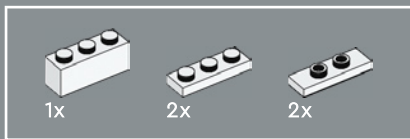

131

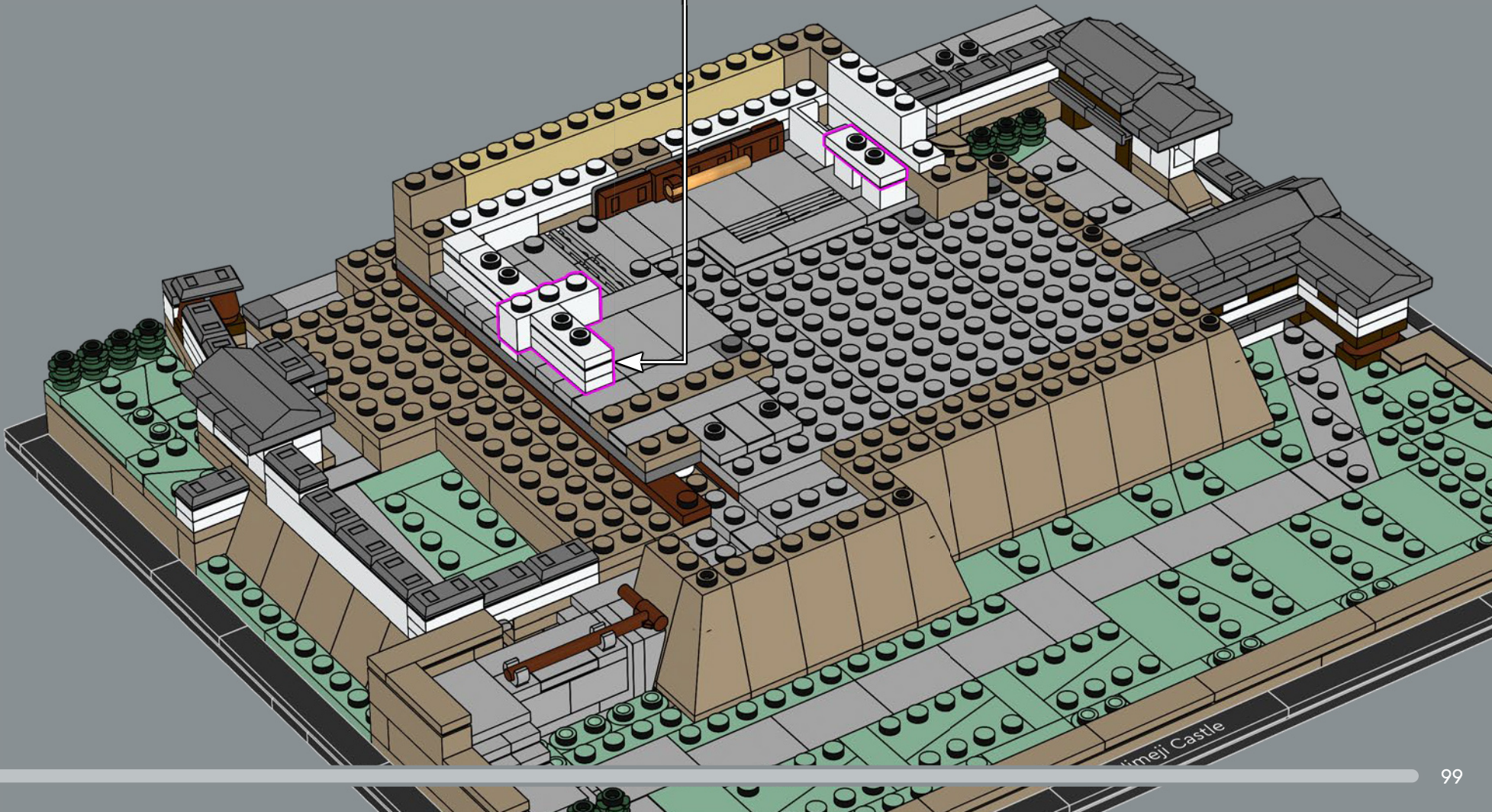
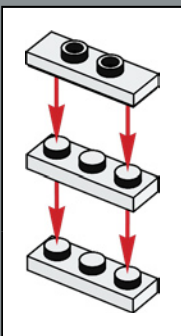

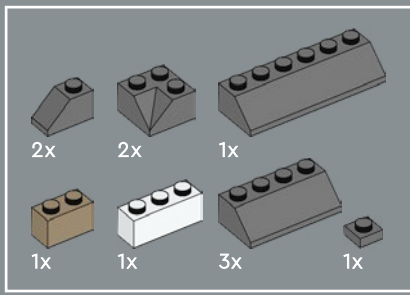

132

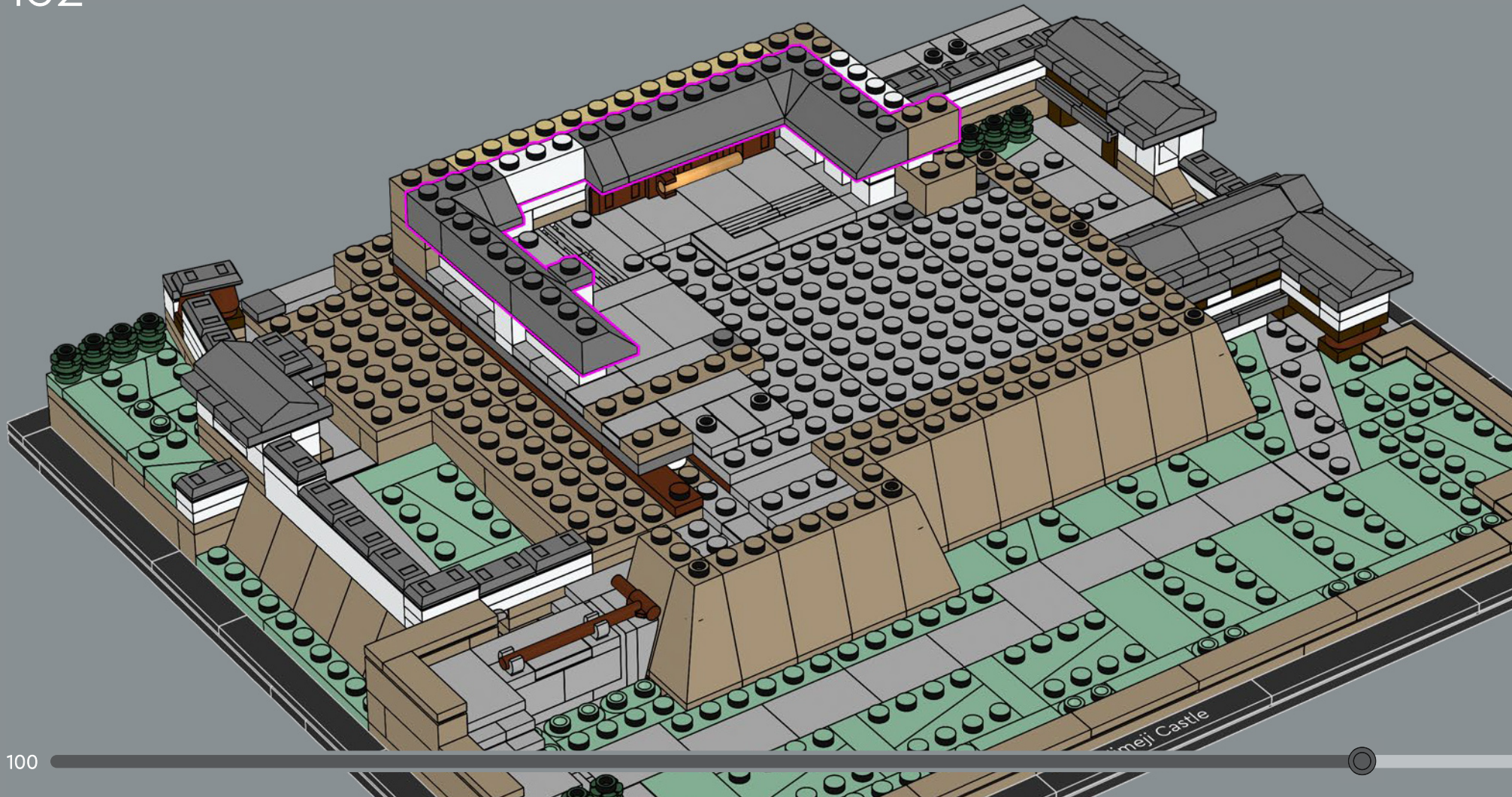

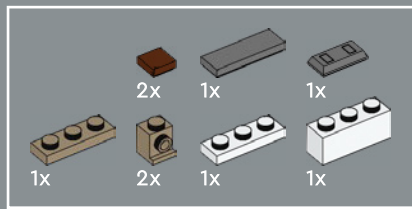

133

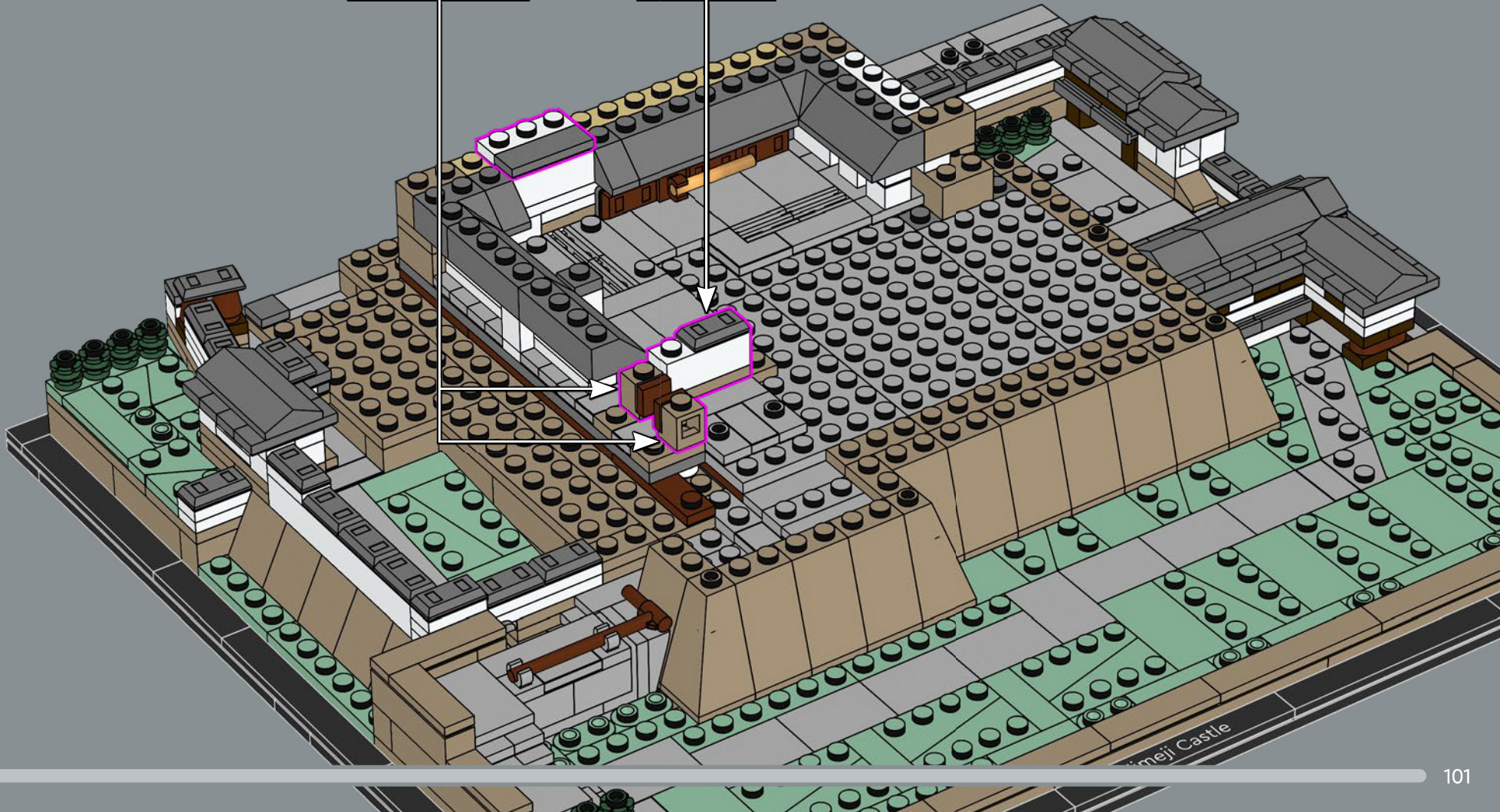
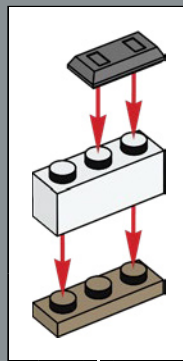
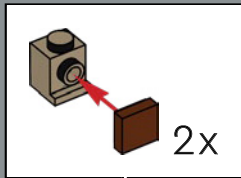

Meiji Castle

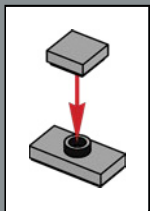
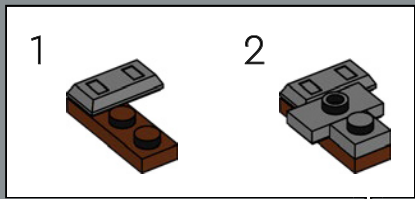
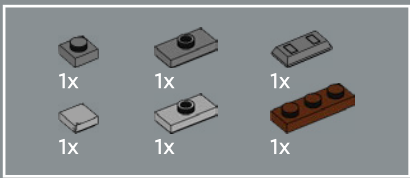

134

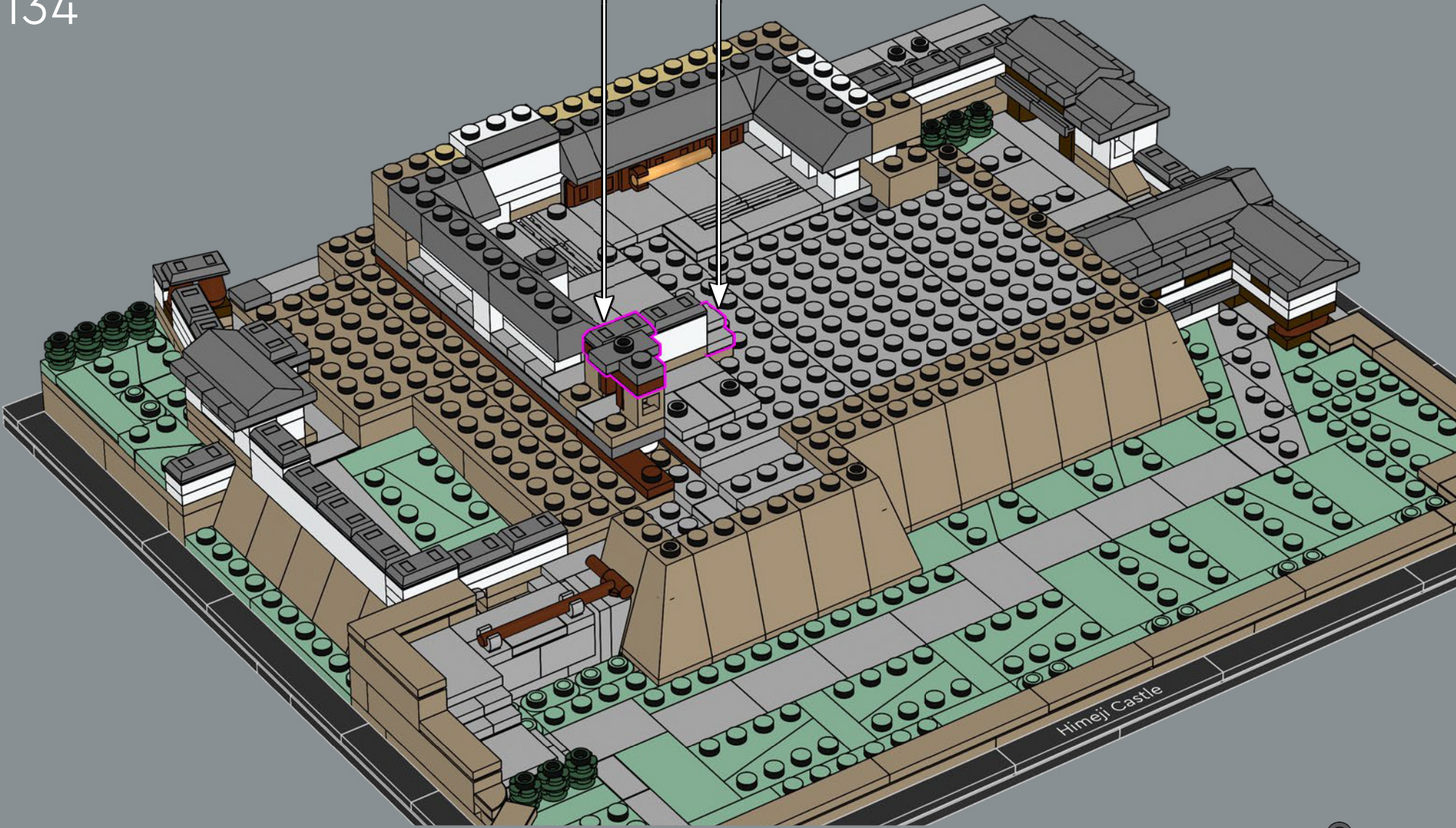

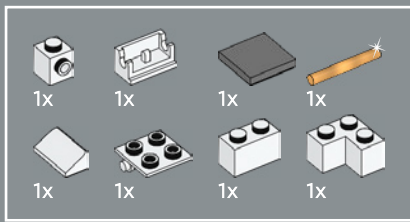

135

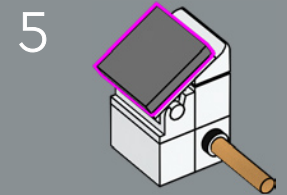
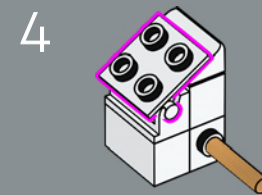
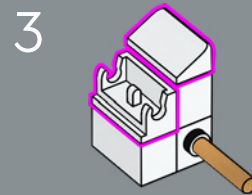
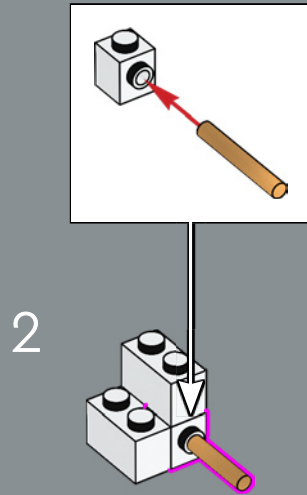
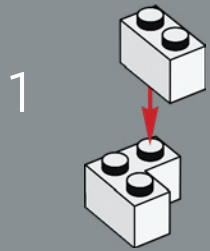

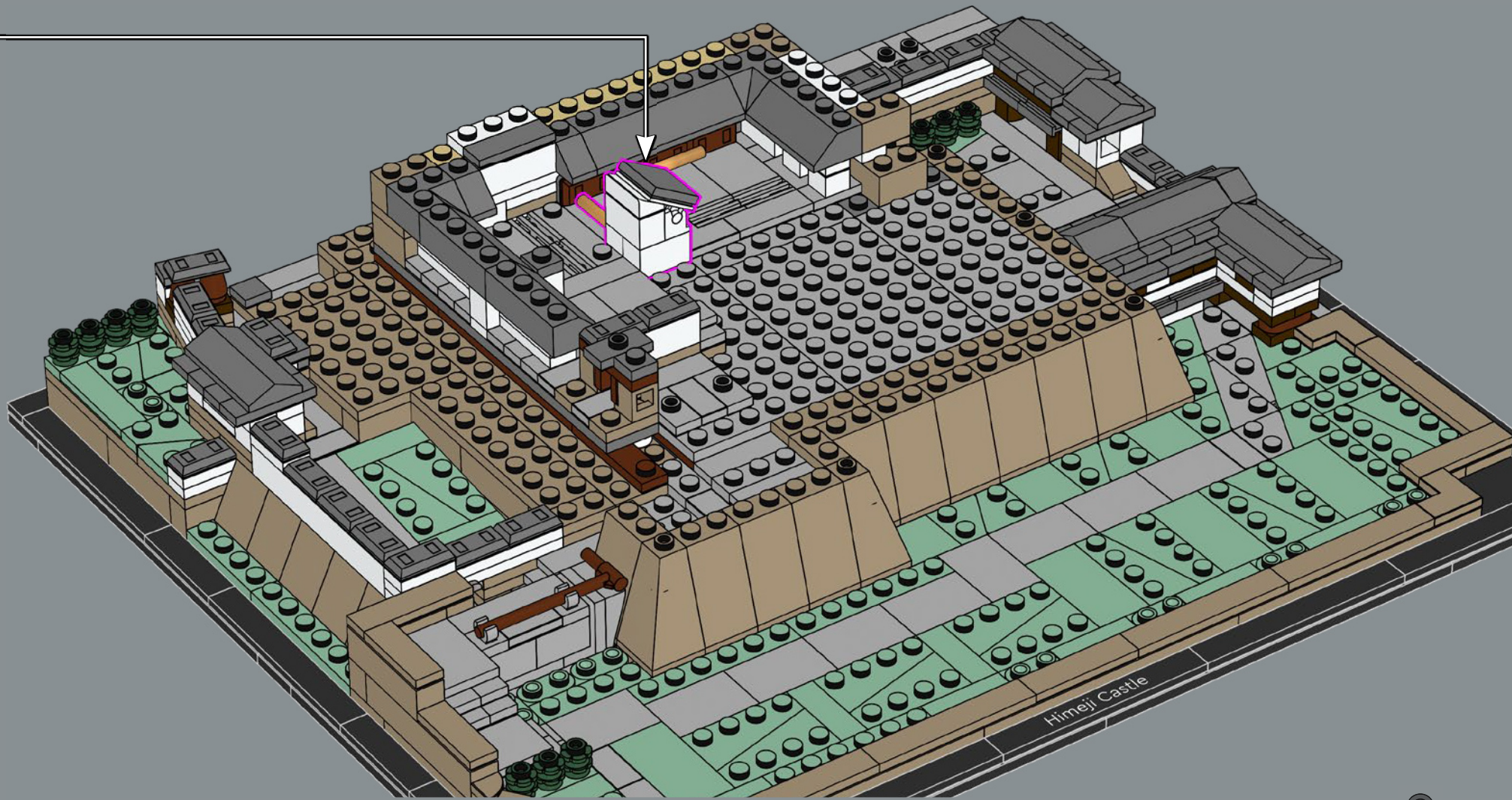

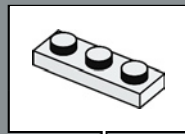
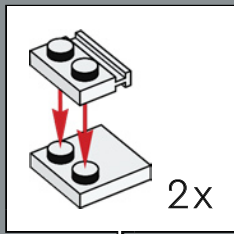
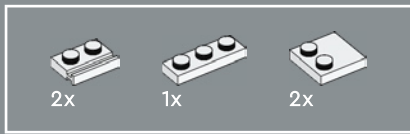

136

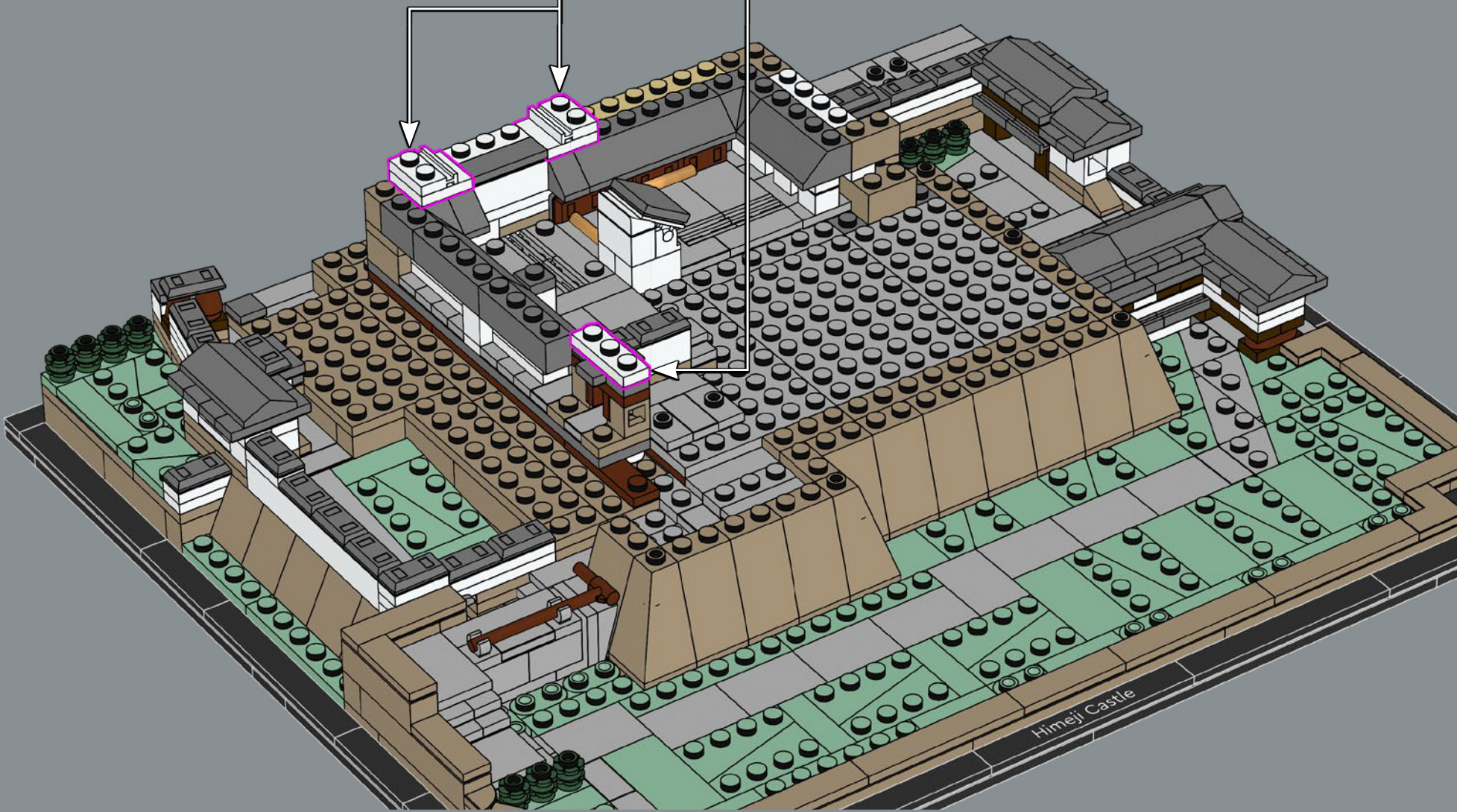

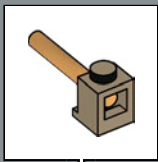
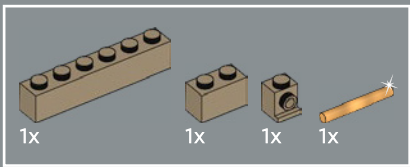

137

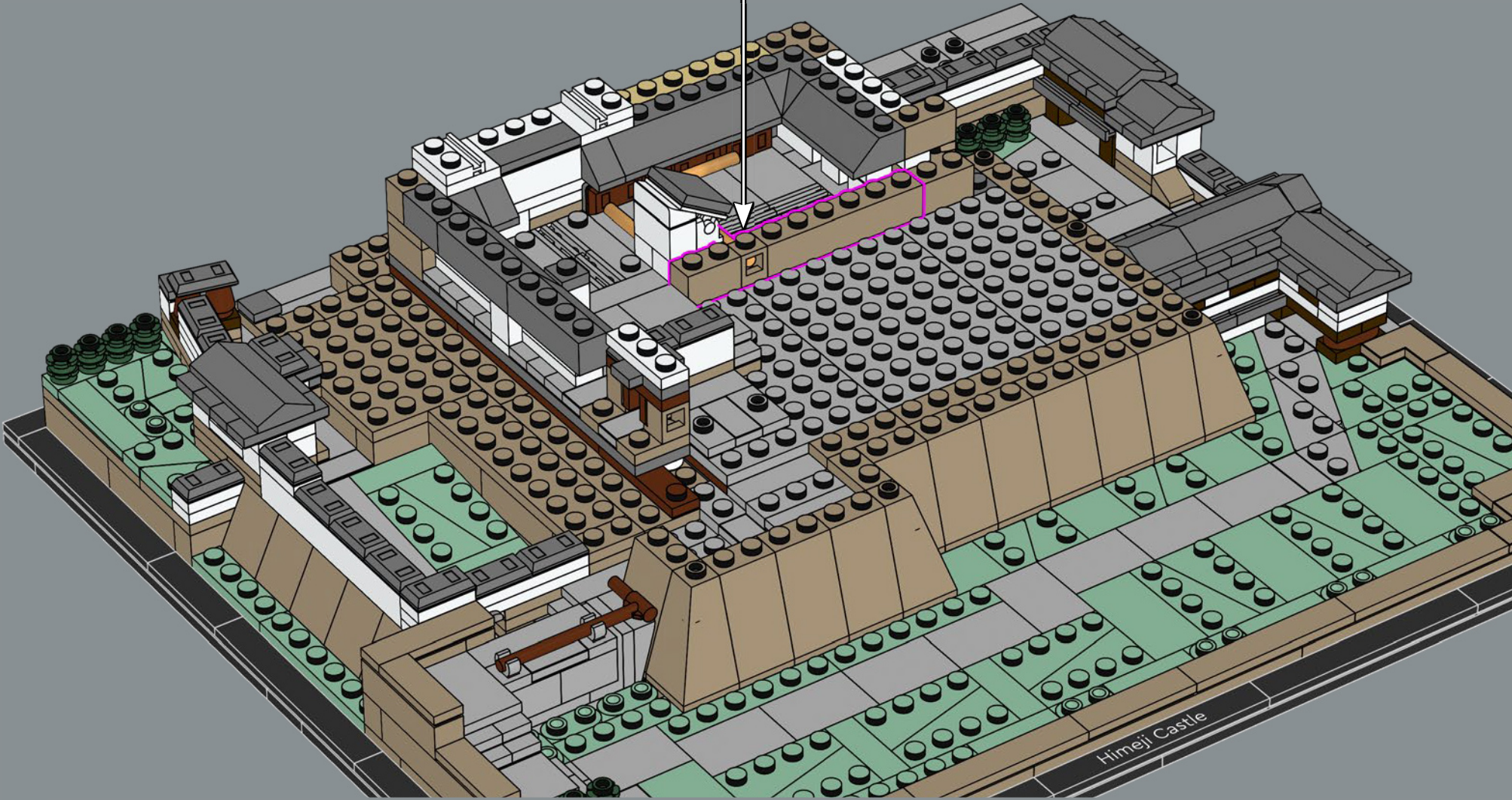

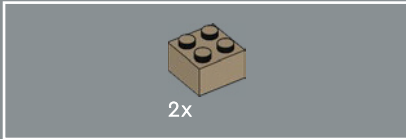
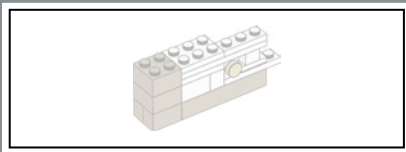

138

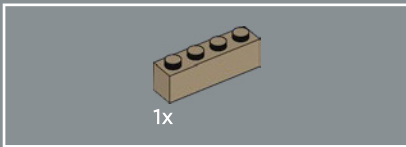
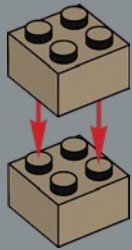

139

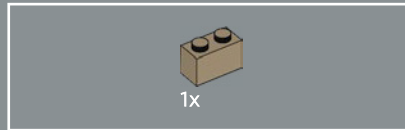
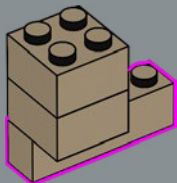

140

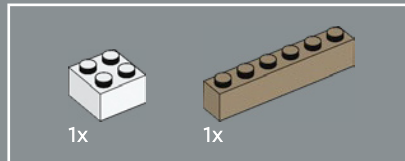
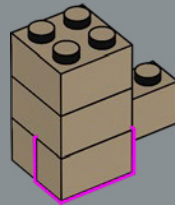

141

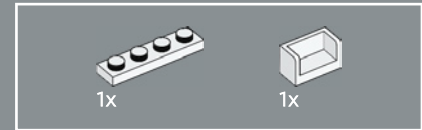
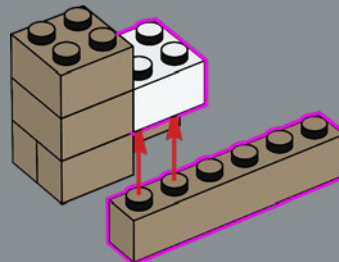

142

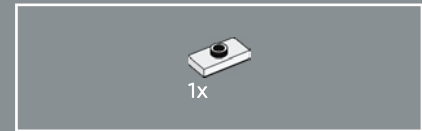
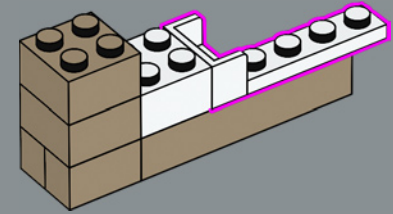

143

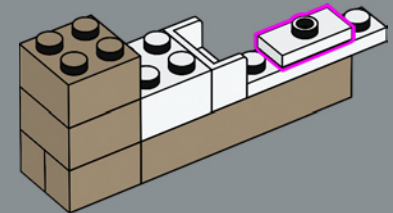

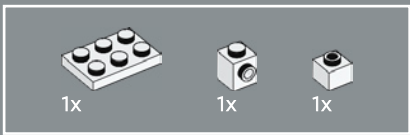

144

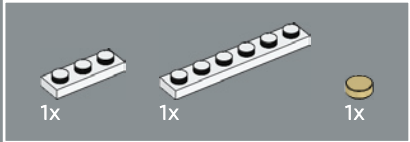
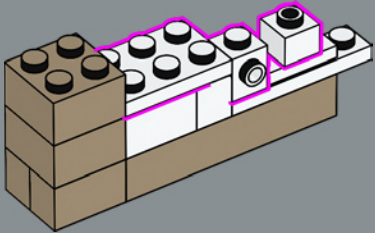

145

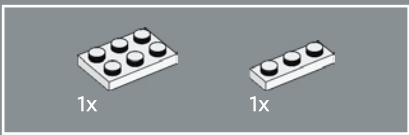
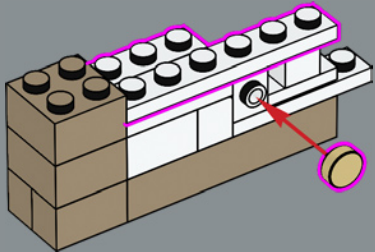

146

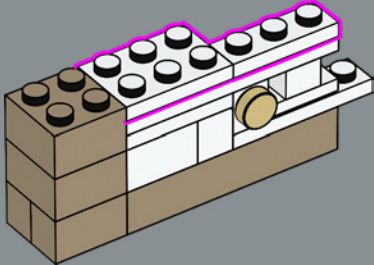

147

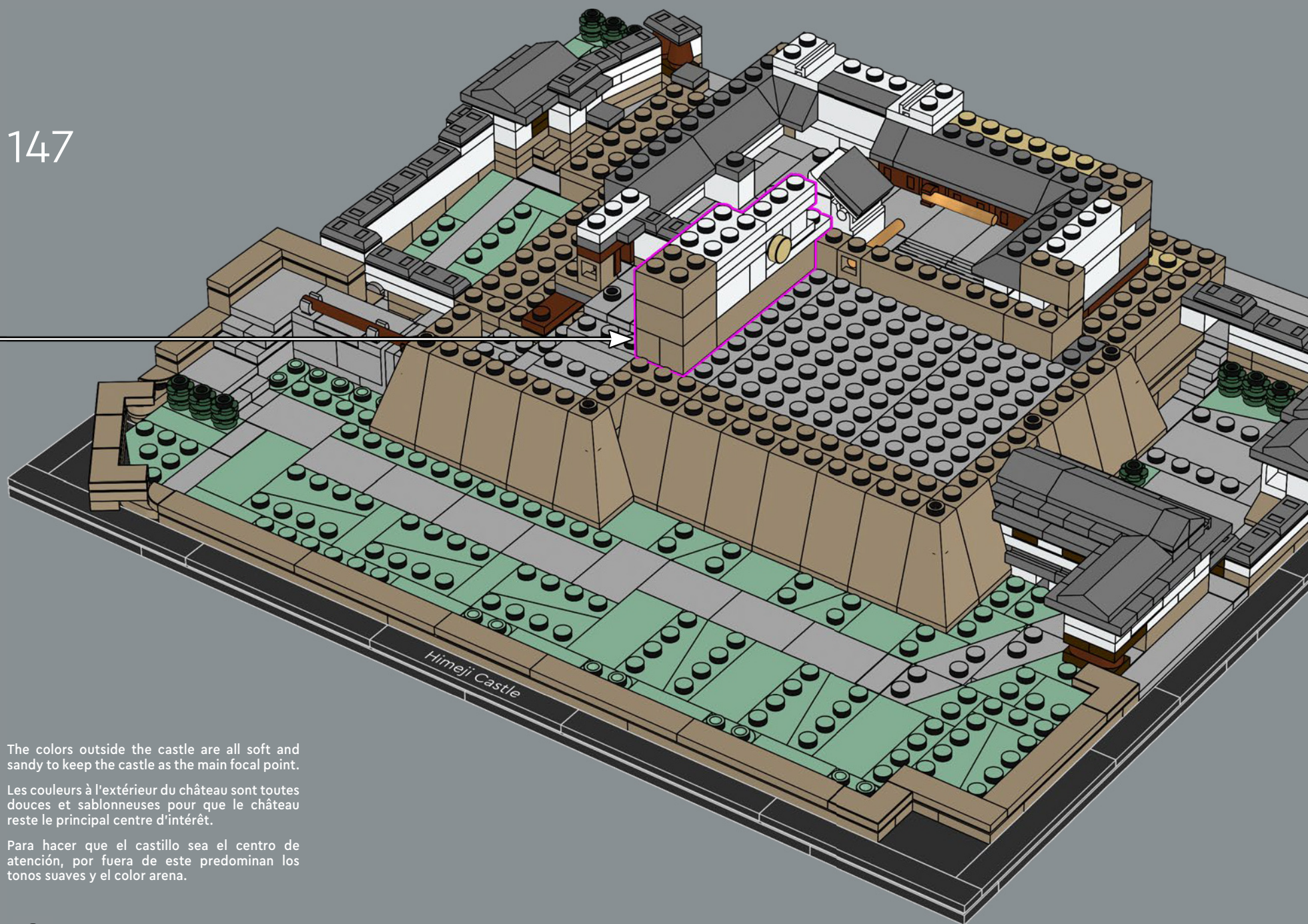

The colors outside the castle are all soft and sandy to keep the castle as the main focal point.

Les couleurs à l'extérieur du château sont toutes douces et sablonneuses pour que le château reste le principal centre d'intérêt.

Para hacer que el castillo sea el centro de atención, por fuera de este predominan los tonos suaves y el color arena.

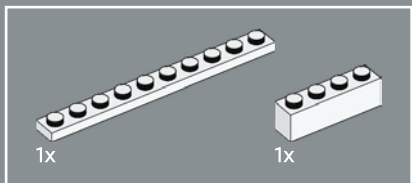

148

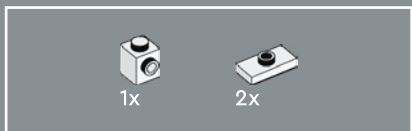
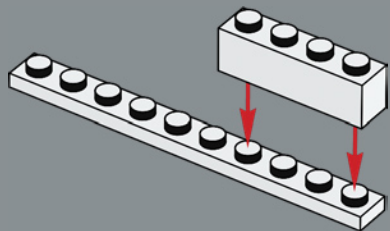

149

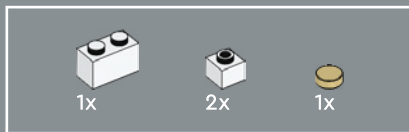
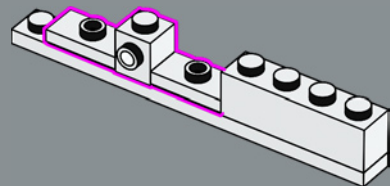

150

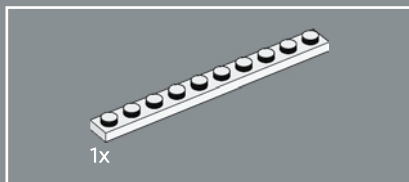
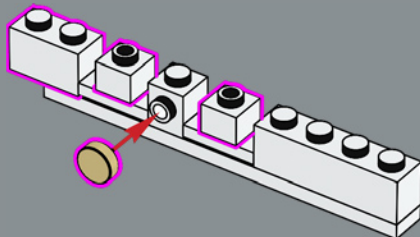

151

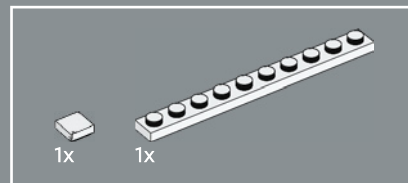
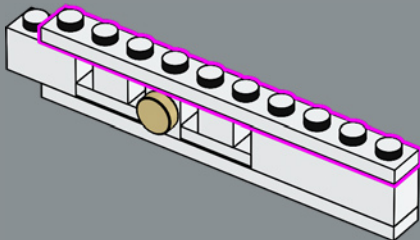

152

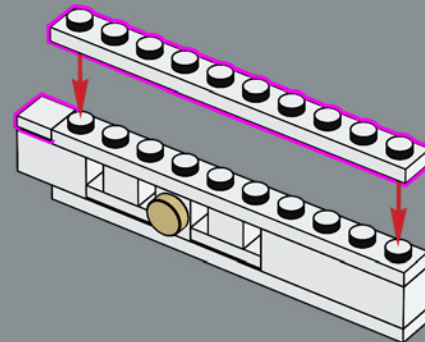

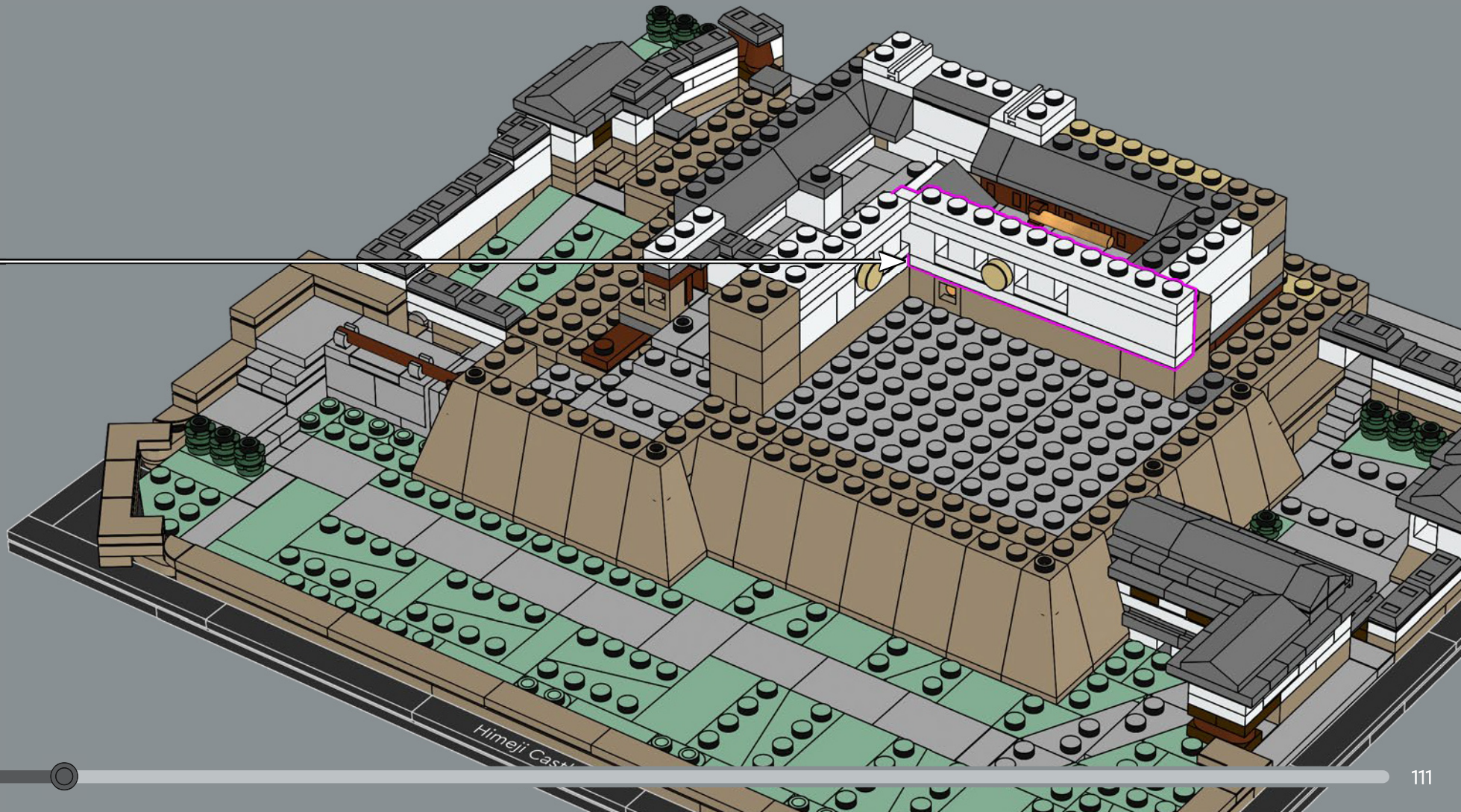

Himeji Castle

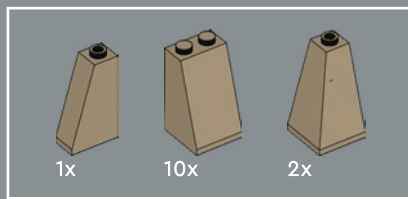

154

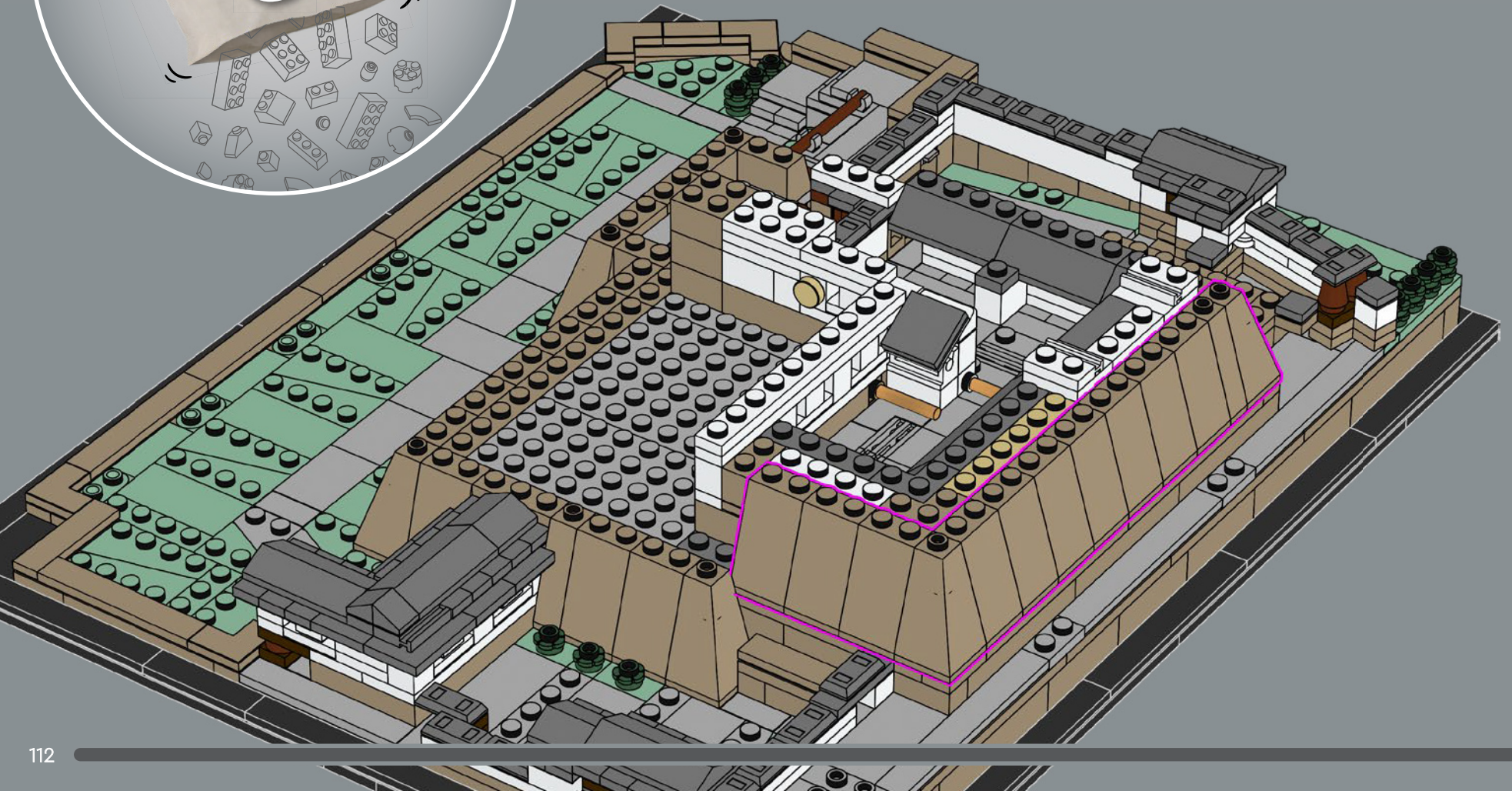

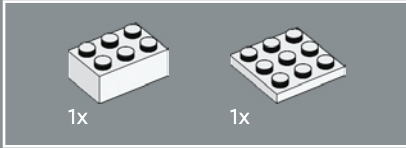

155

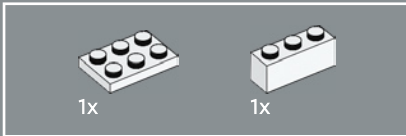
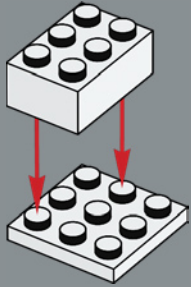

156

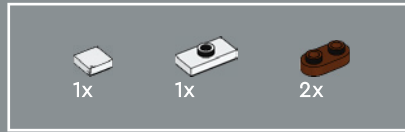
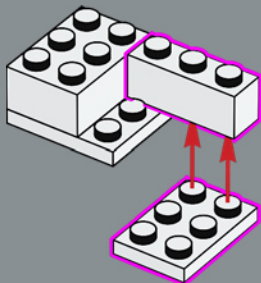

157

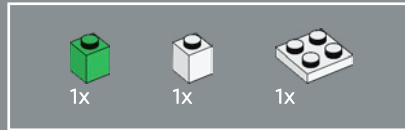
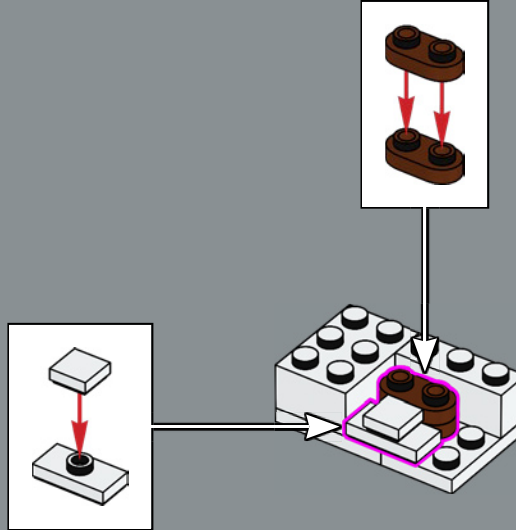

158

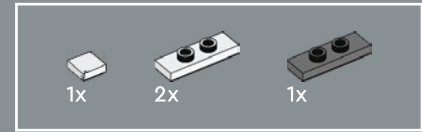
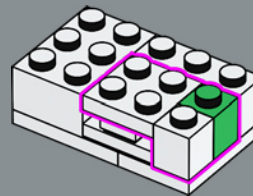

159

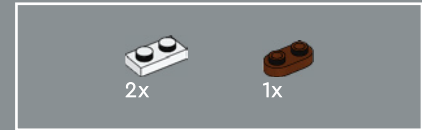
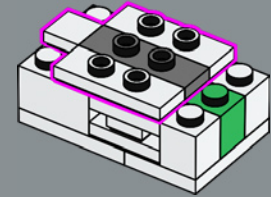

160

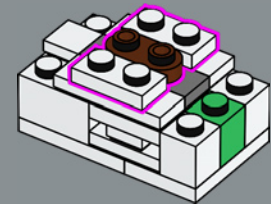

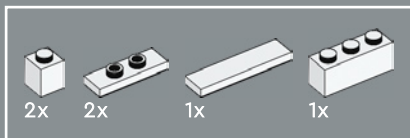

161

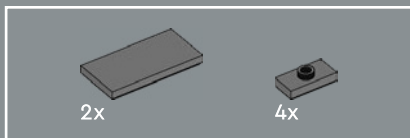
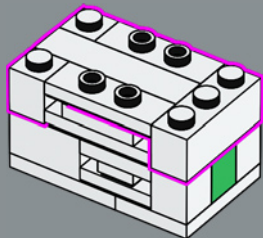

162

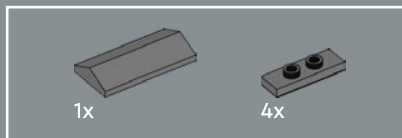
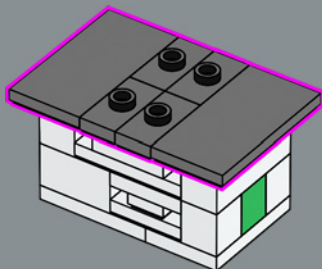

163

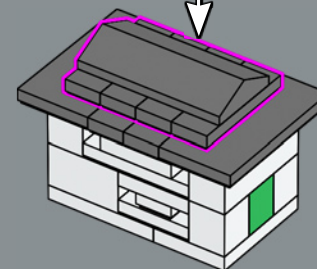
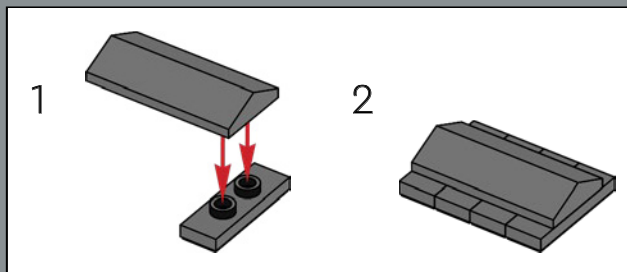

164

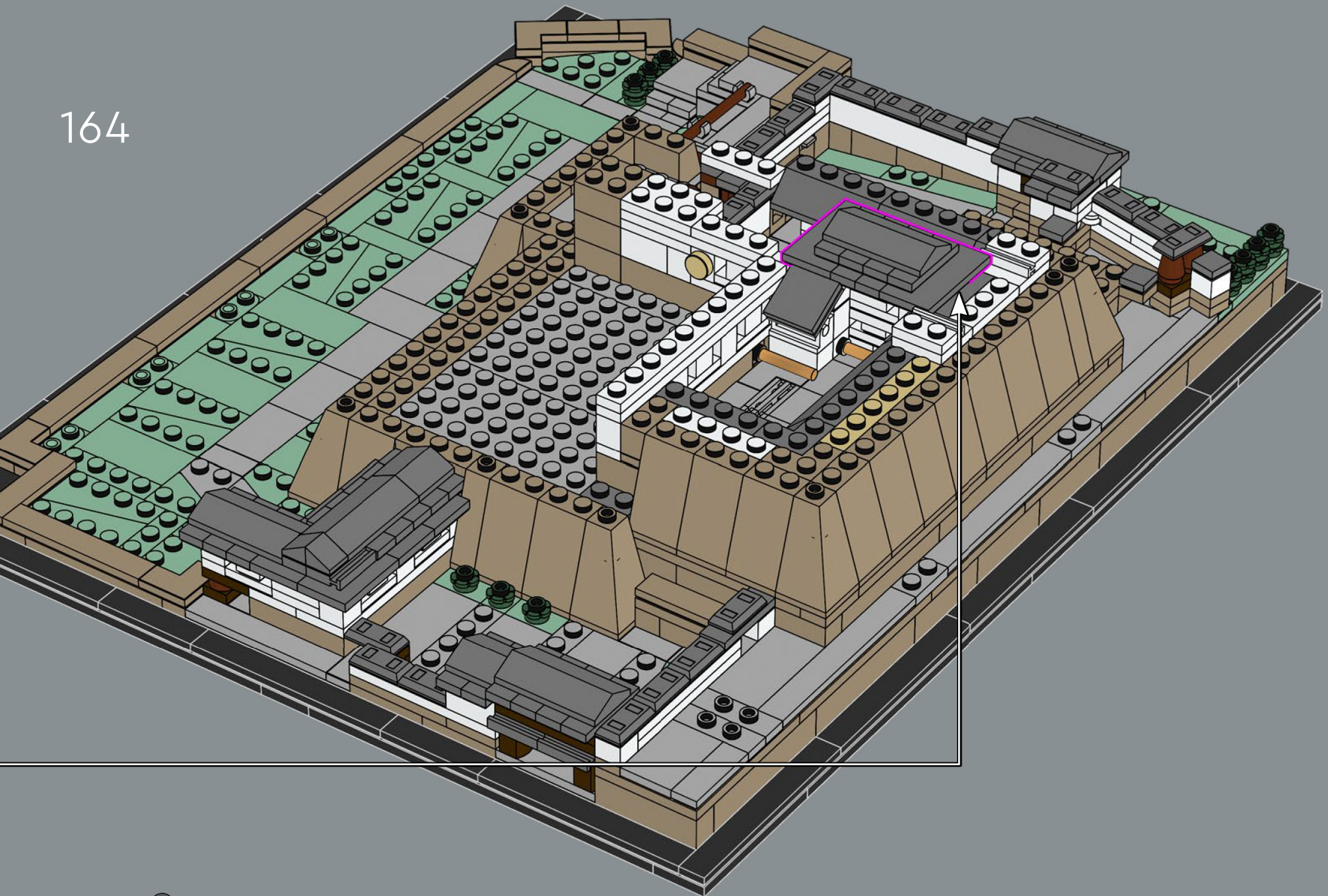

169

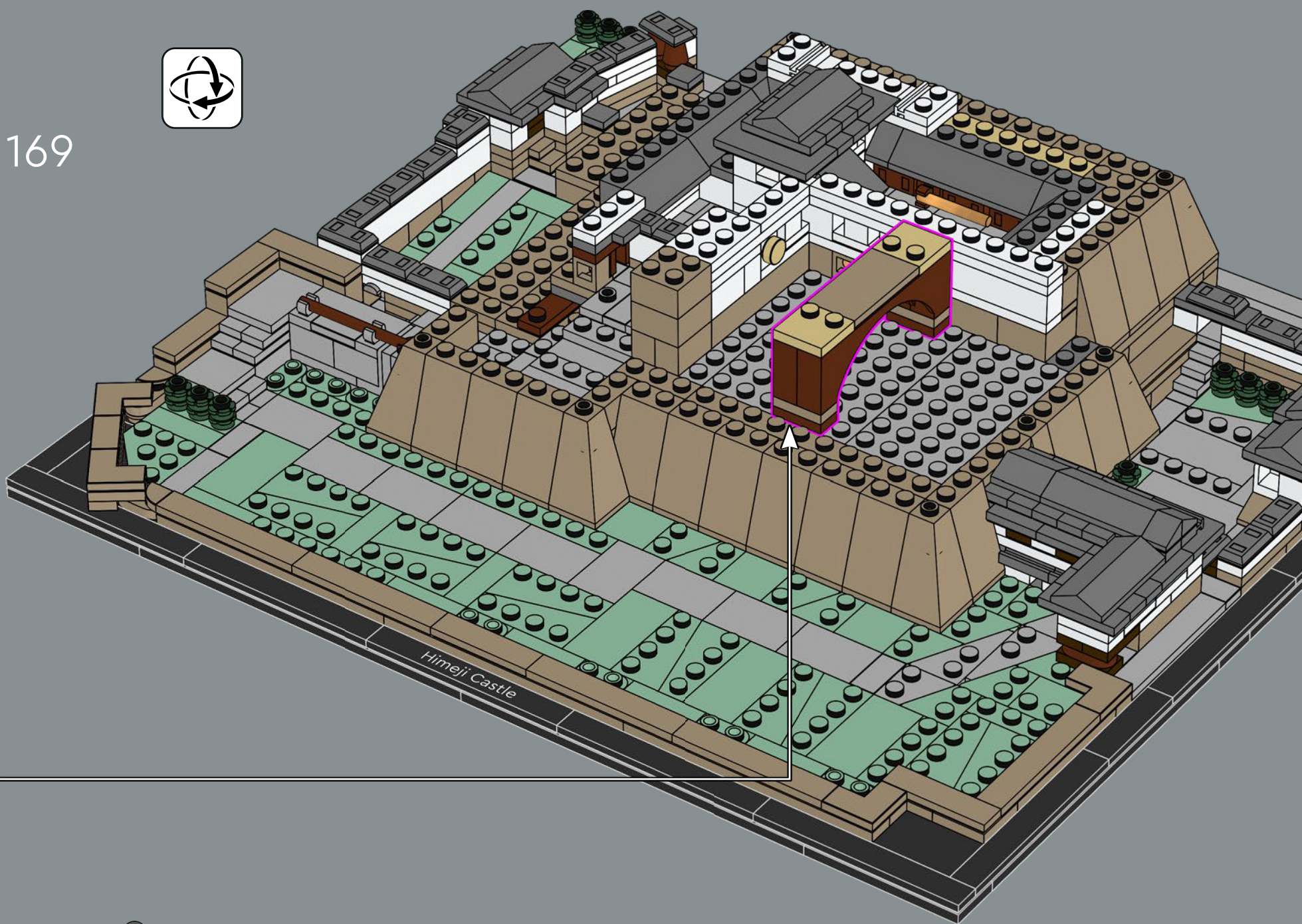

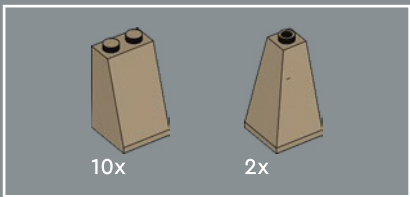

170

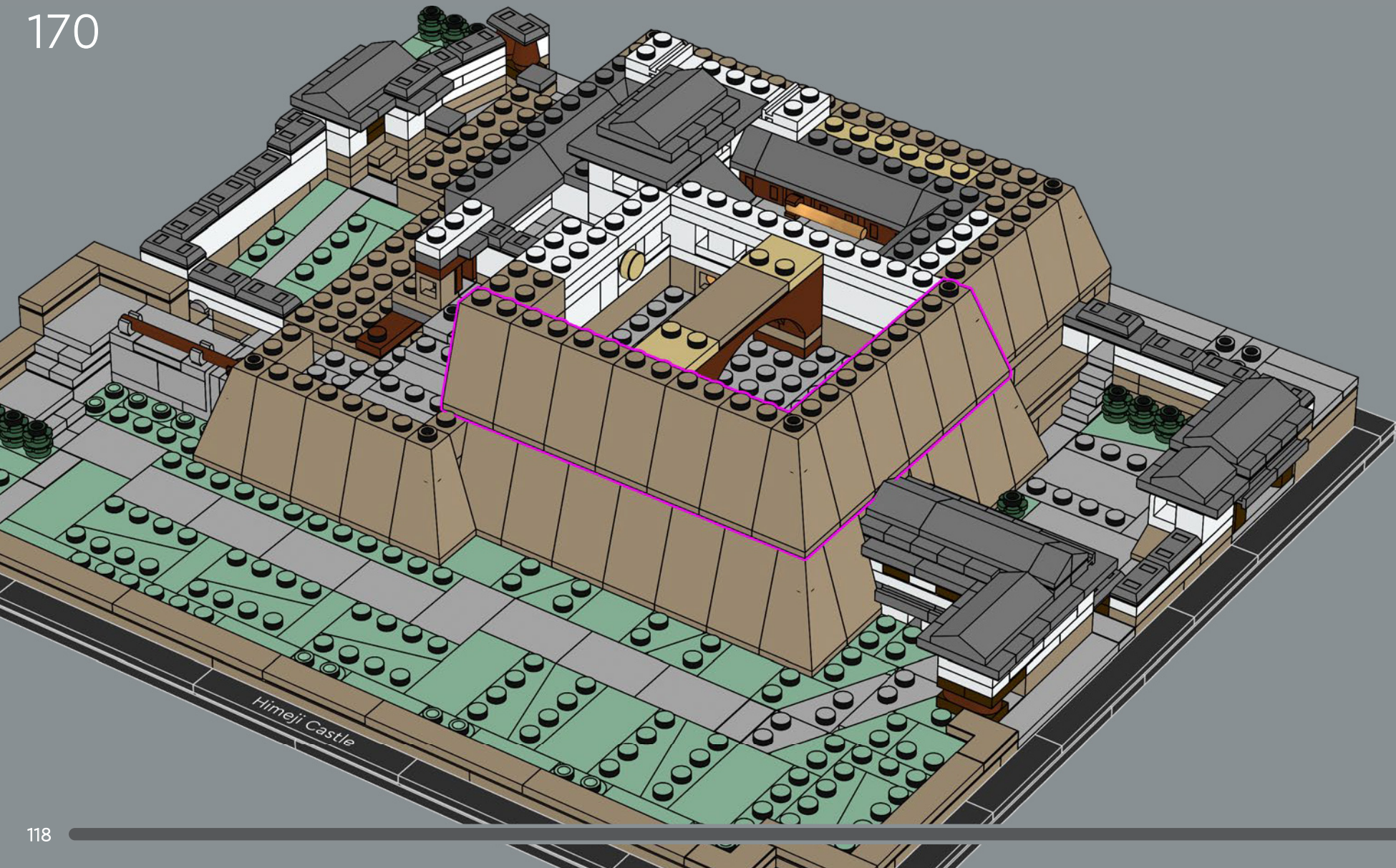

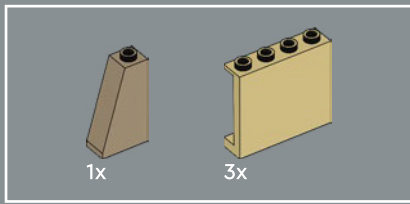

171



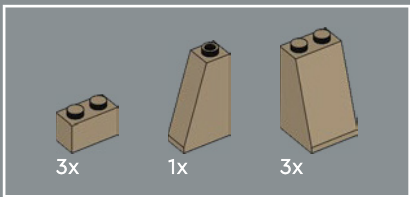

172

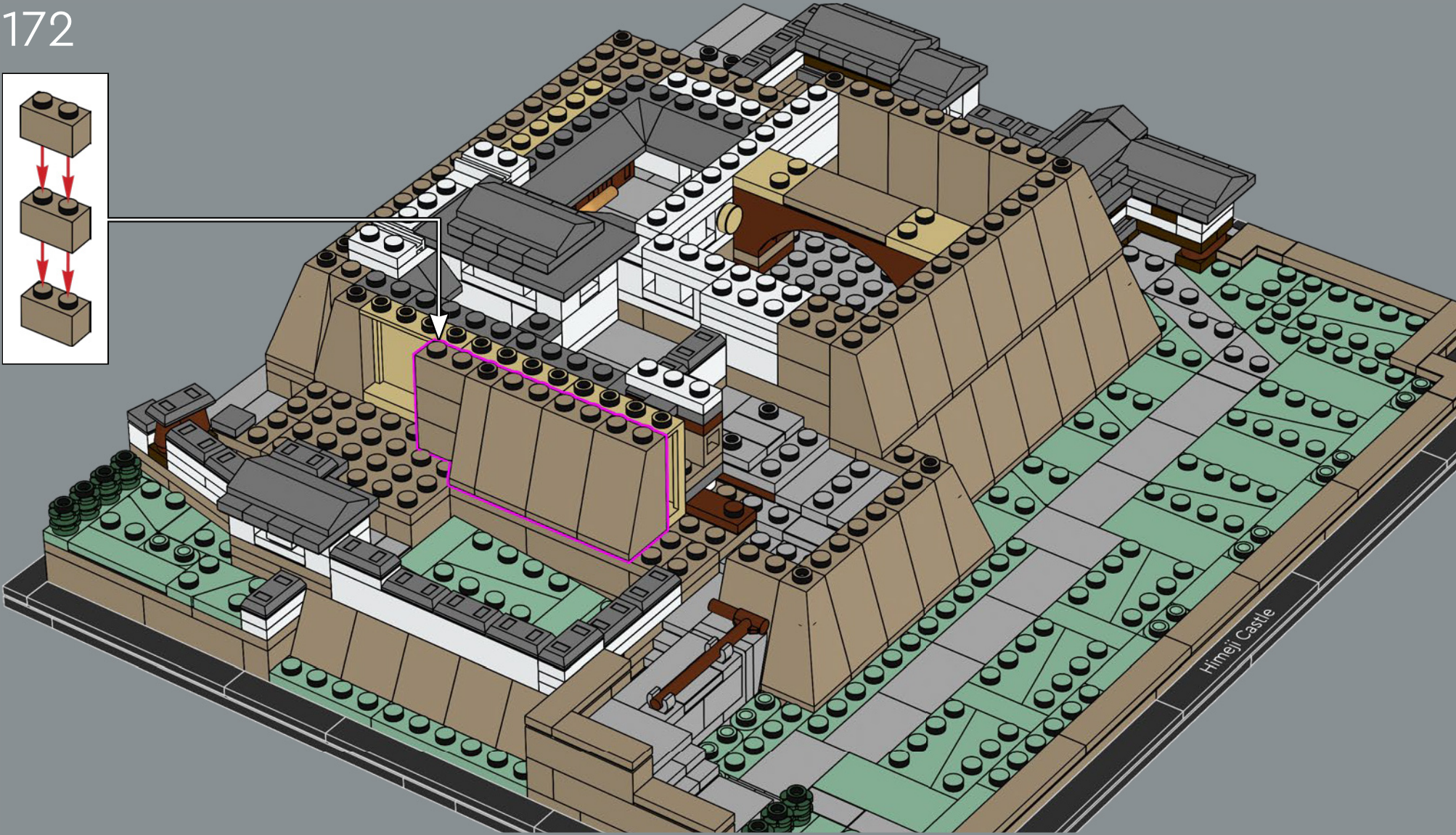
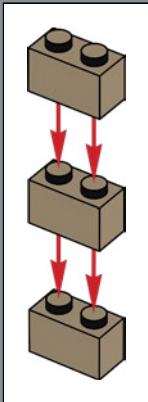

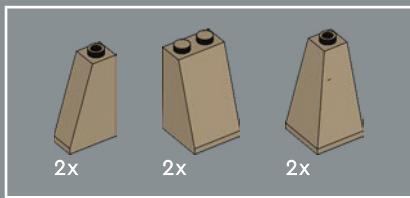

173



Himeji Castle

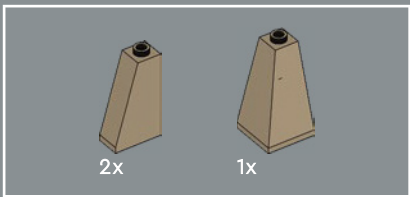

174

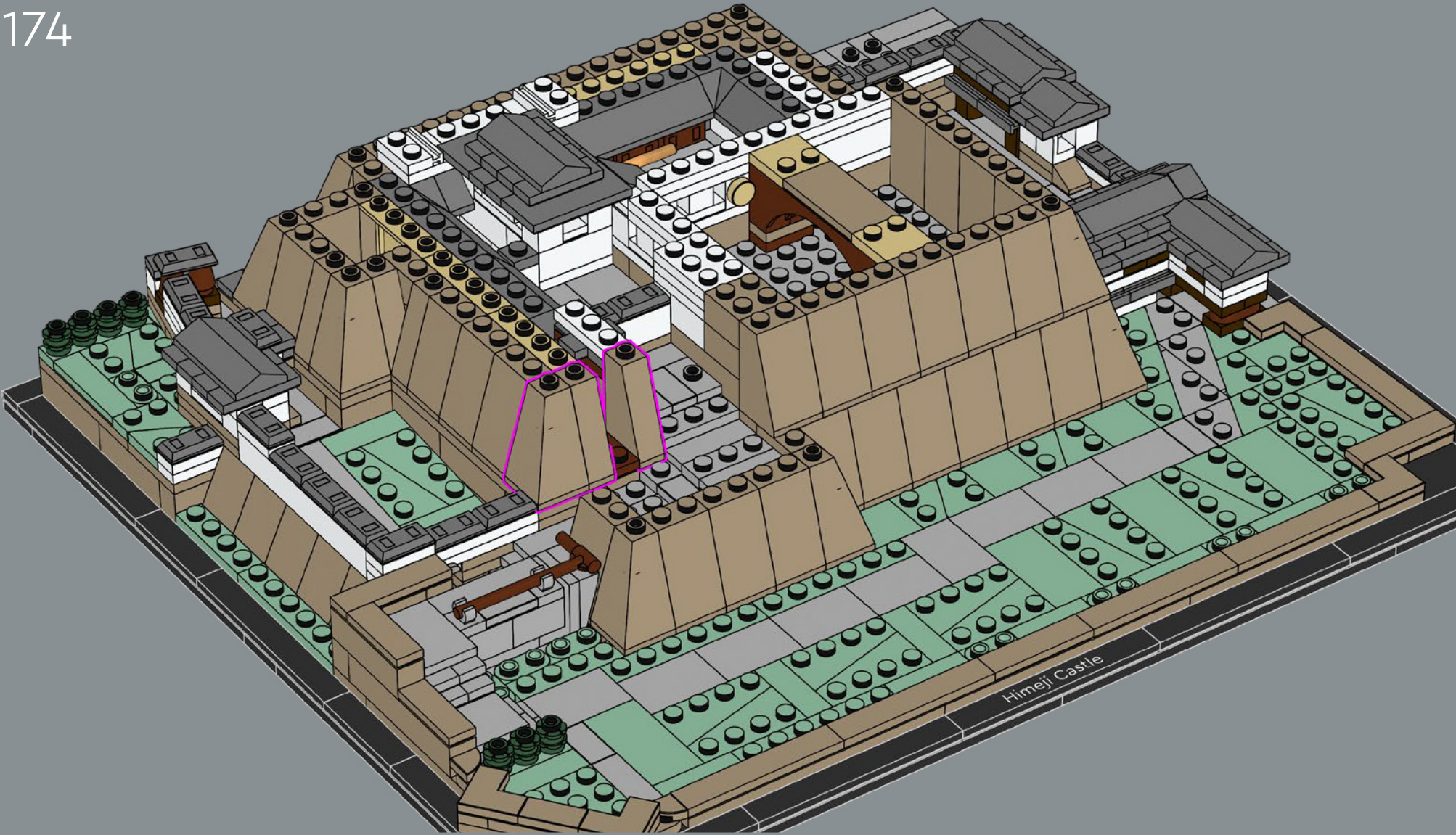

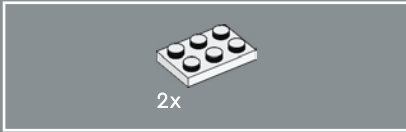
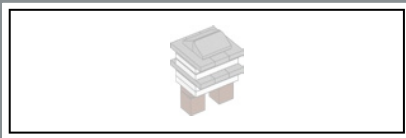

175

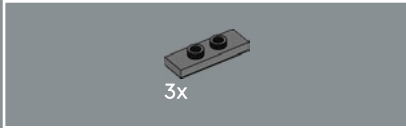
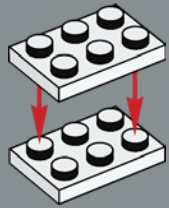

176

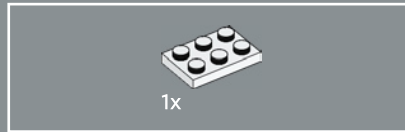

177

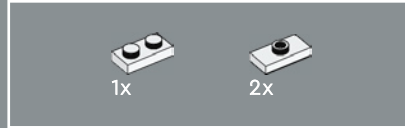
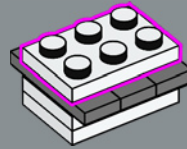

178

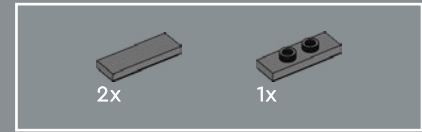
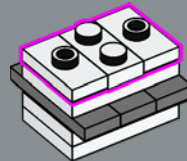

179

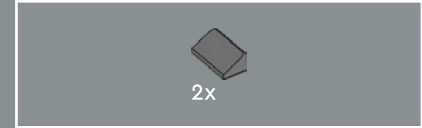
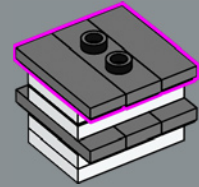

180

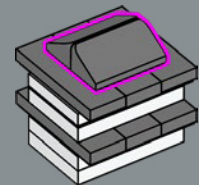

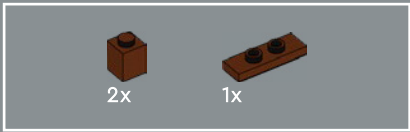

181

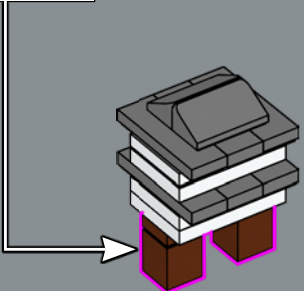
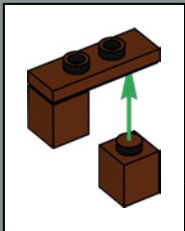

182

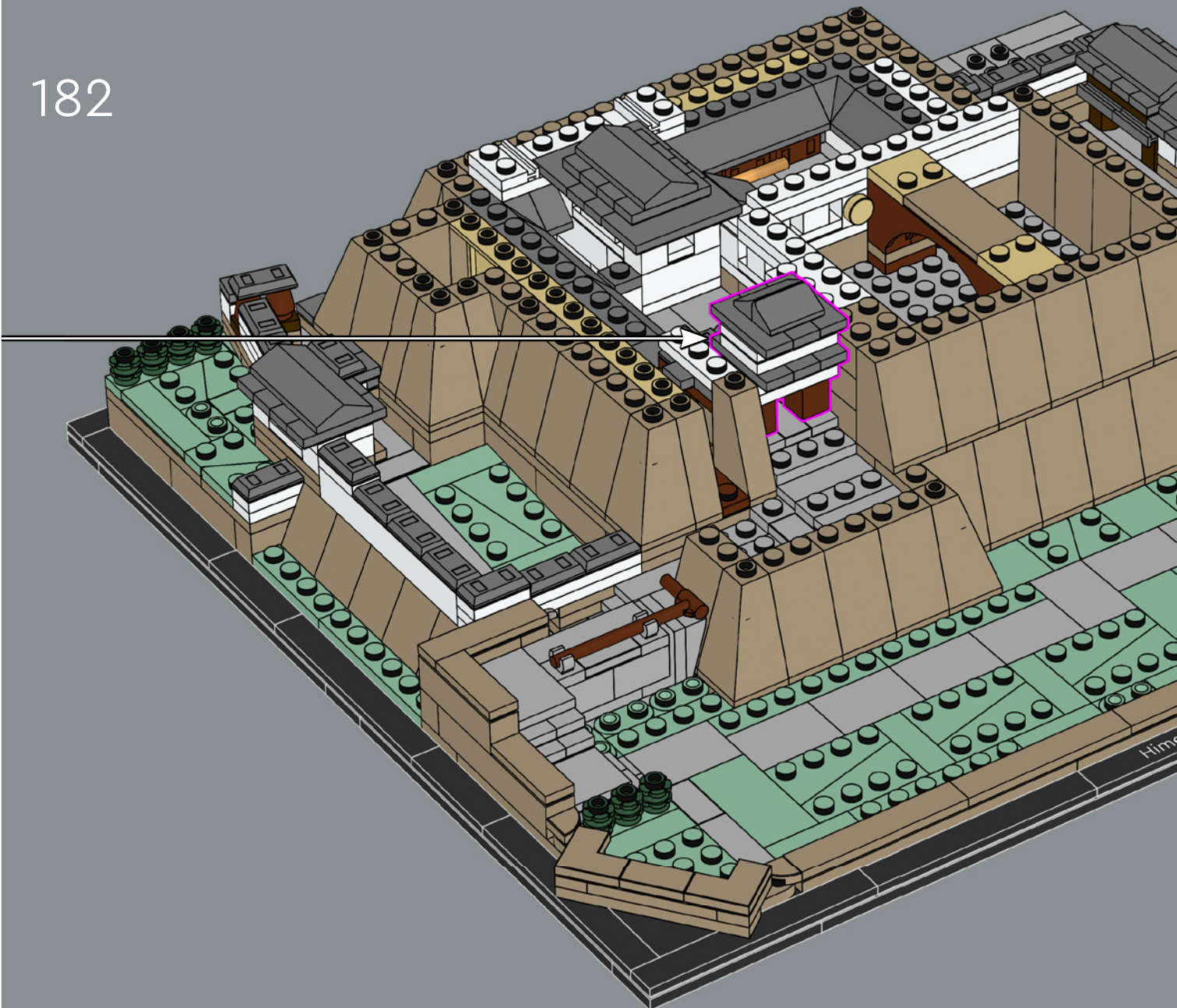

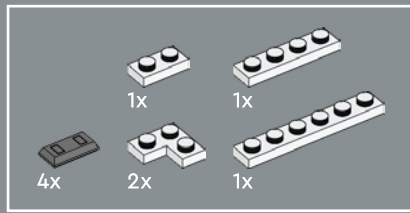

183

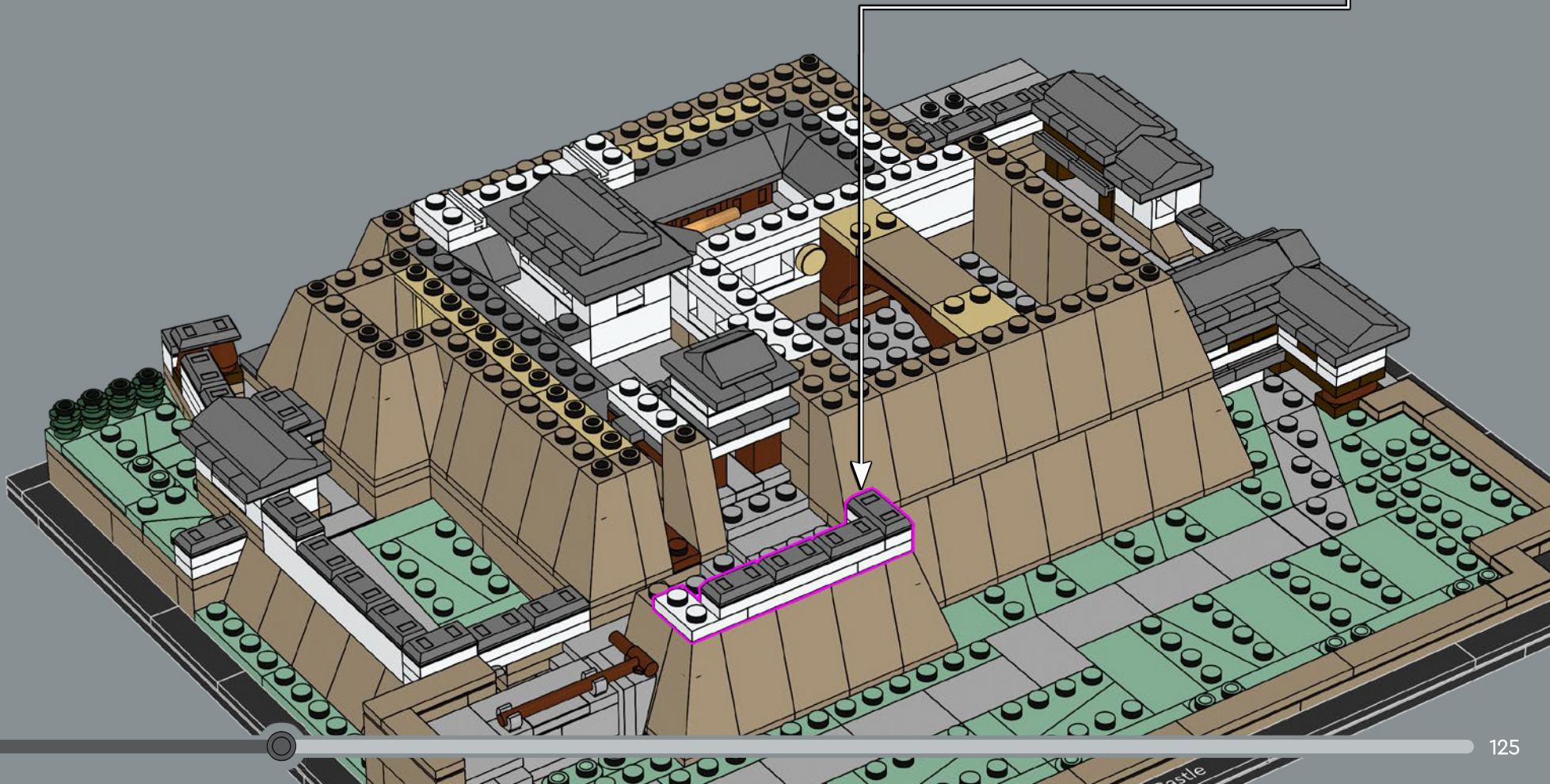
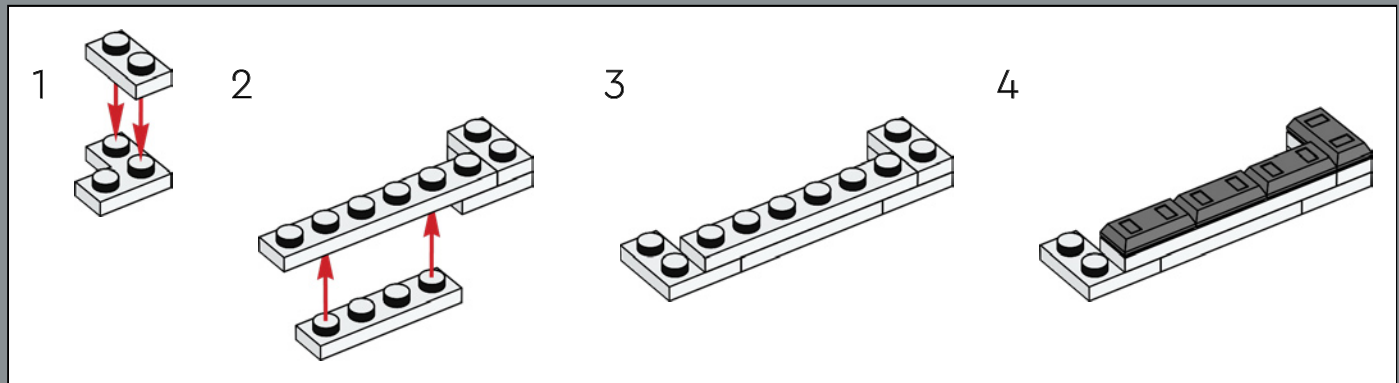

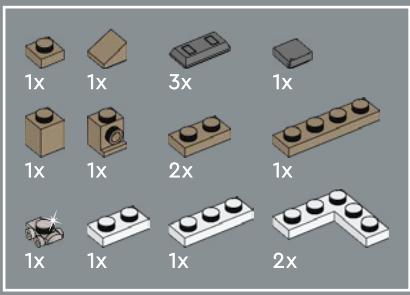

184

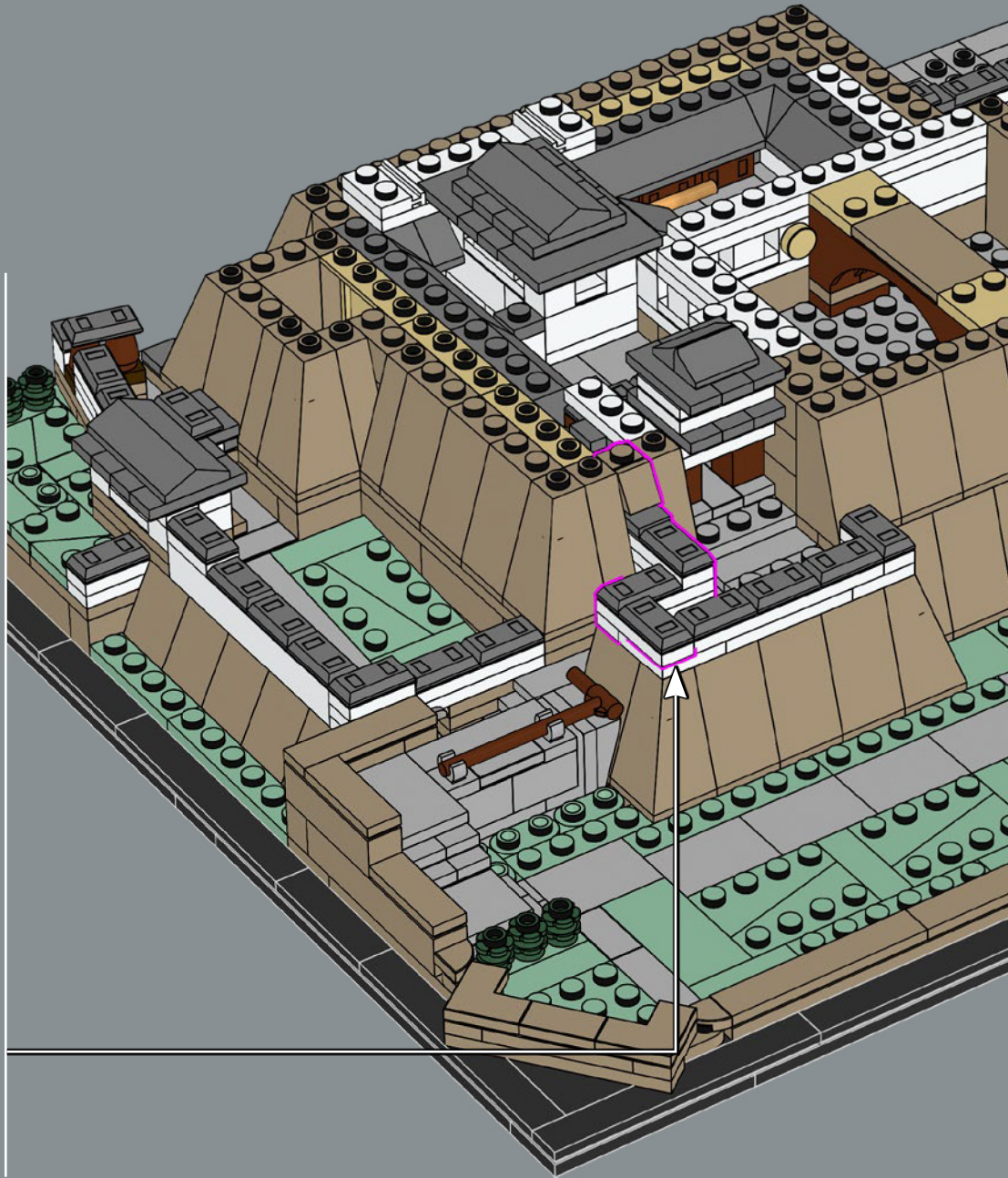
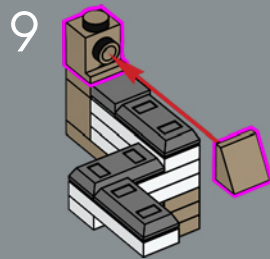
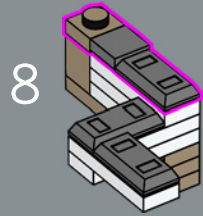
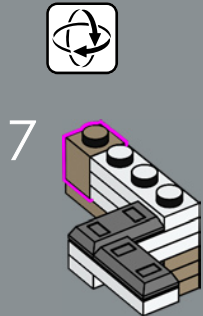
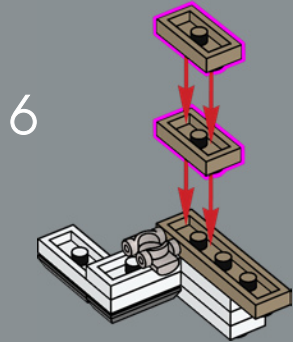
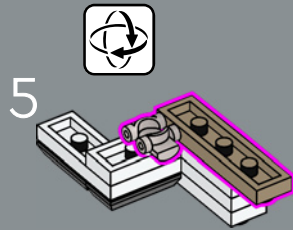
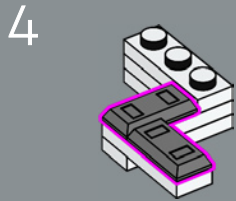
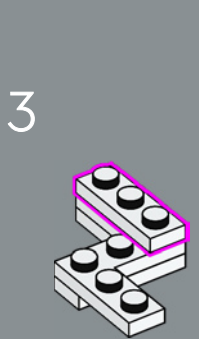
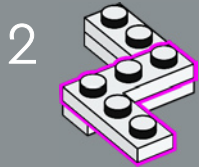
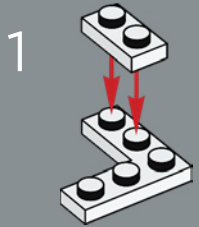

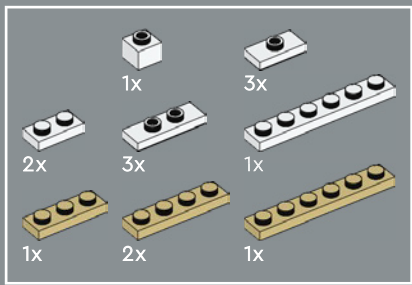

186

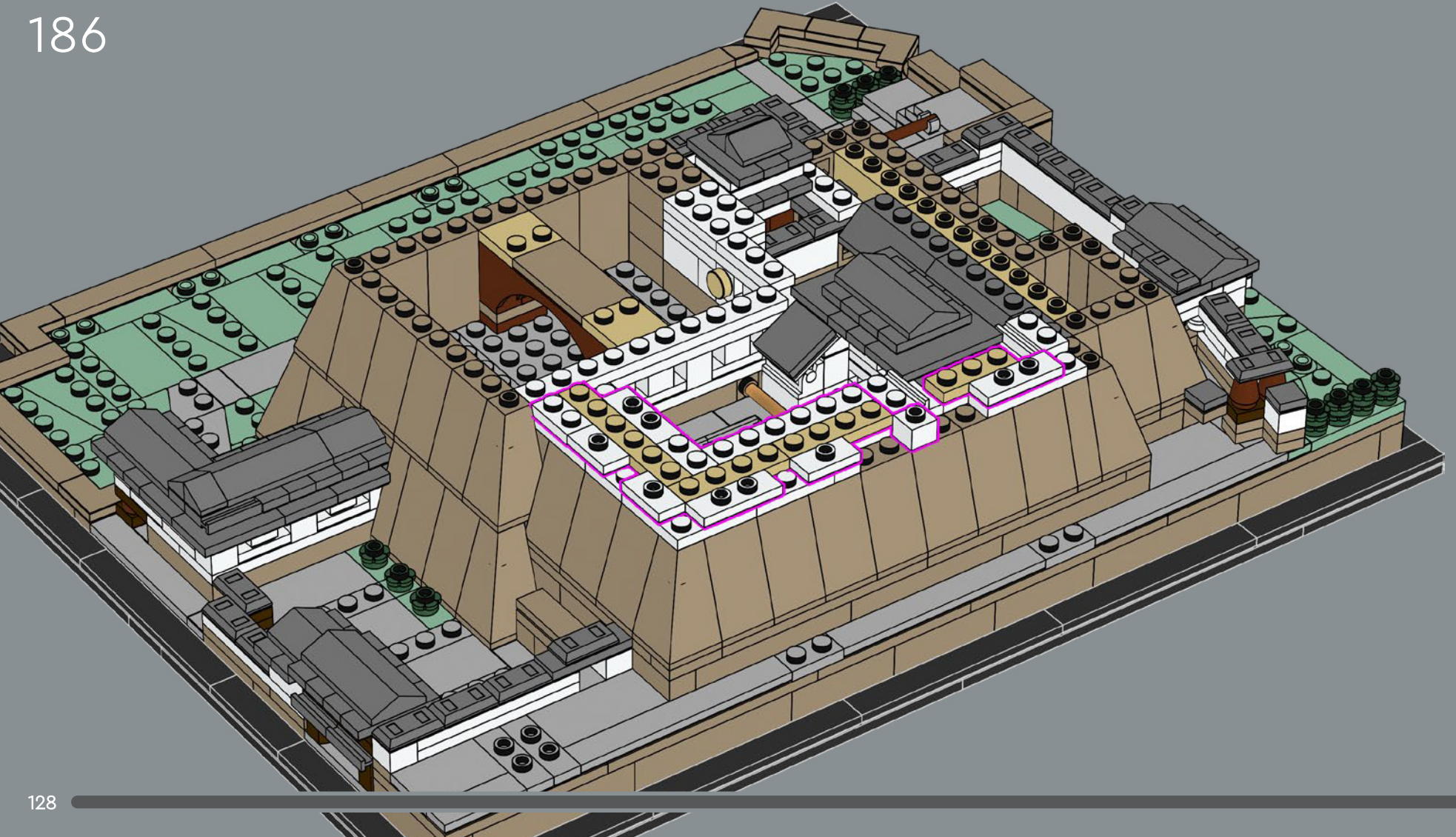

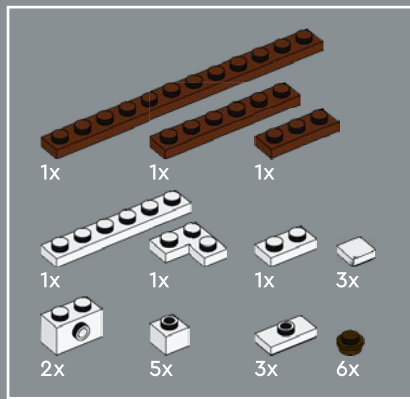

187



During the 2009–2015 renovation, several sides of the exterior scaffolding had line art drawings of the castle to keep the iconic landmark visible on the Himeji skyline.

Au cours de sa rénovation, de 2009 à 2015, plusieurs côtés de l'échafaudage extérieur ont été ornés de dessins aux traits du château, afin que le monument emblématique reste visible dans l'horizon de Himeji.

Durante la renovación de 2009–2015, varios lados de los andamios exteriores estaban decorados con dibujos del castillo para que su icónica silueta siguiera siendo visible en el horizonte de Himeji.

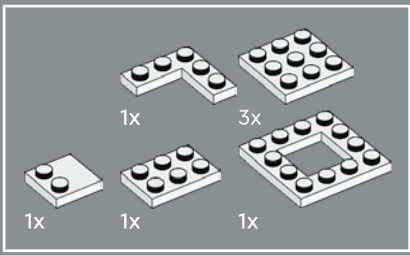

188

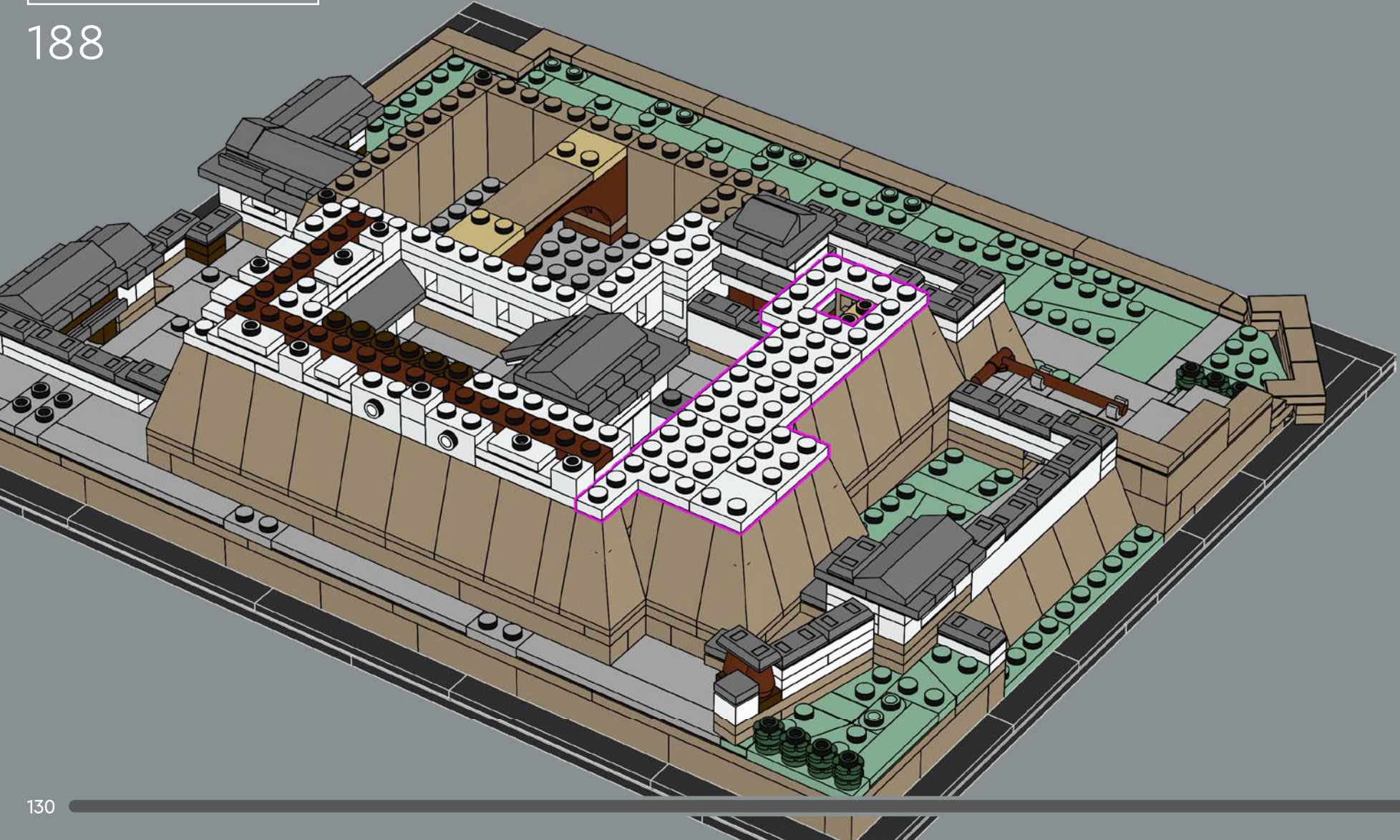

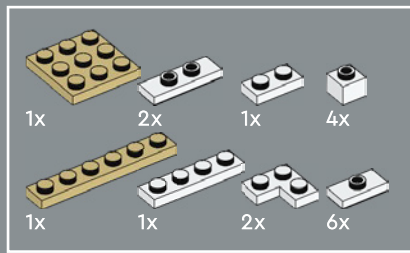

189



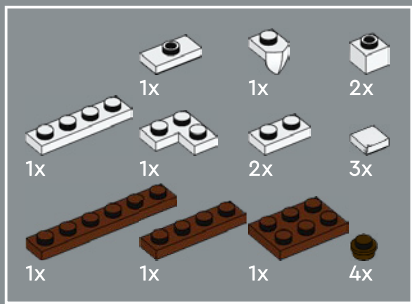

190



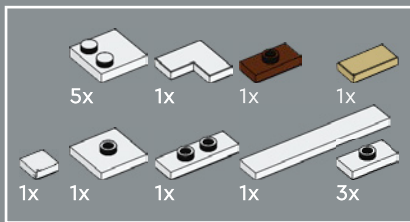

191

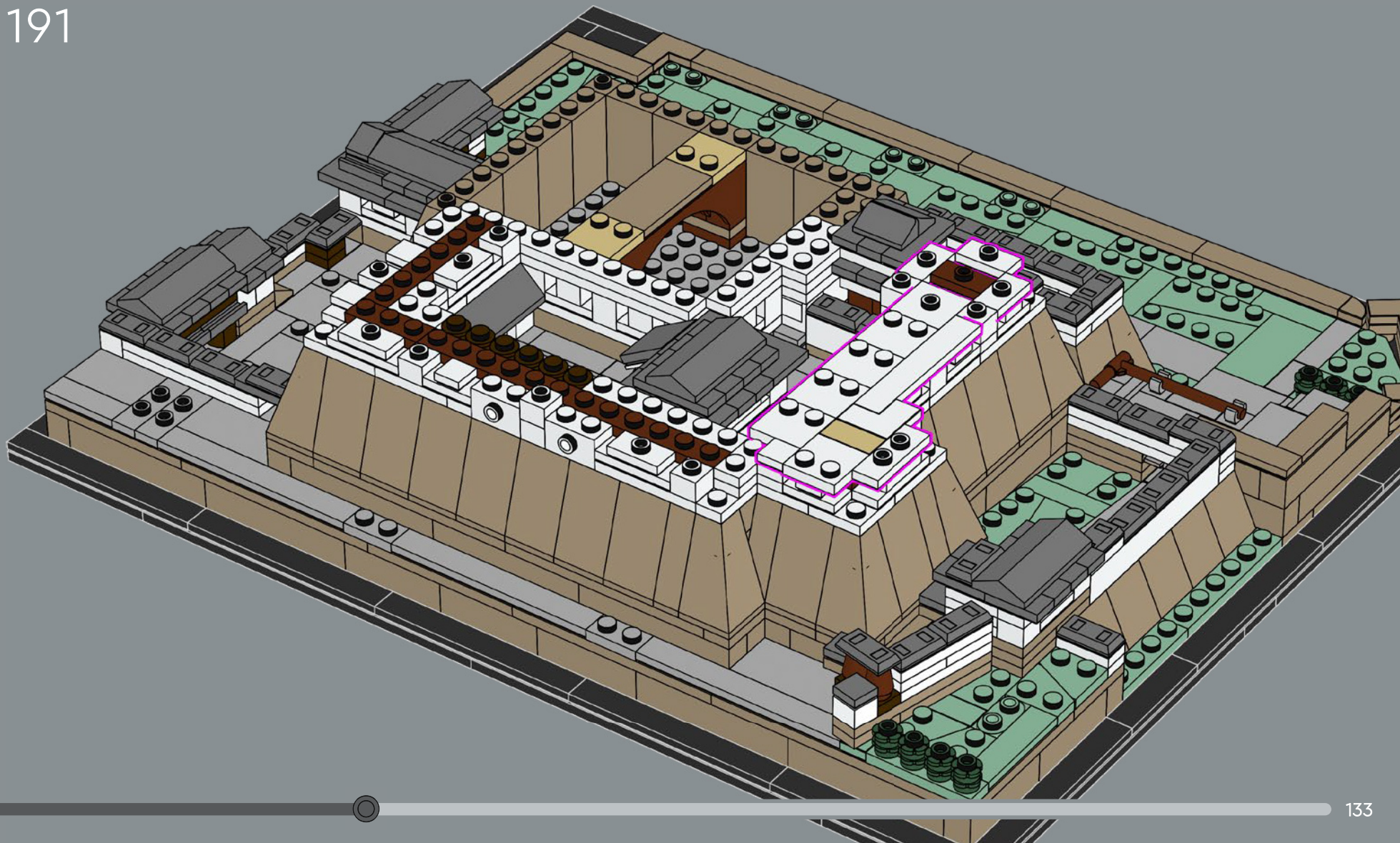

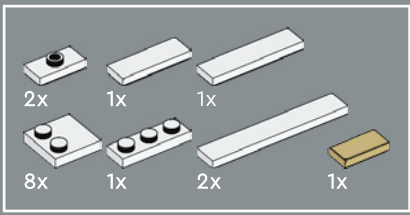

192

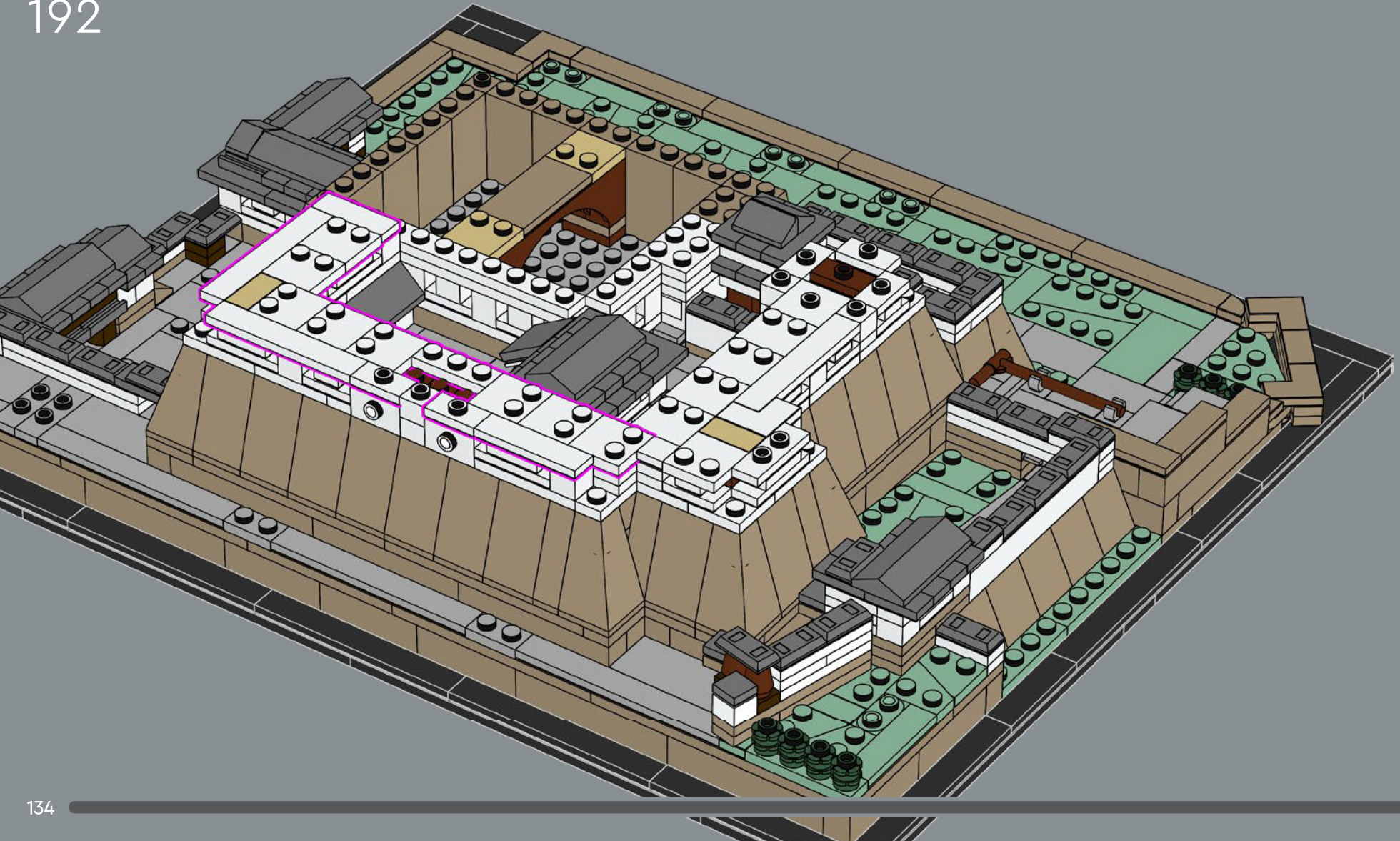

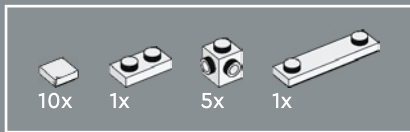

193

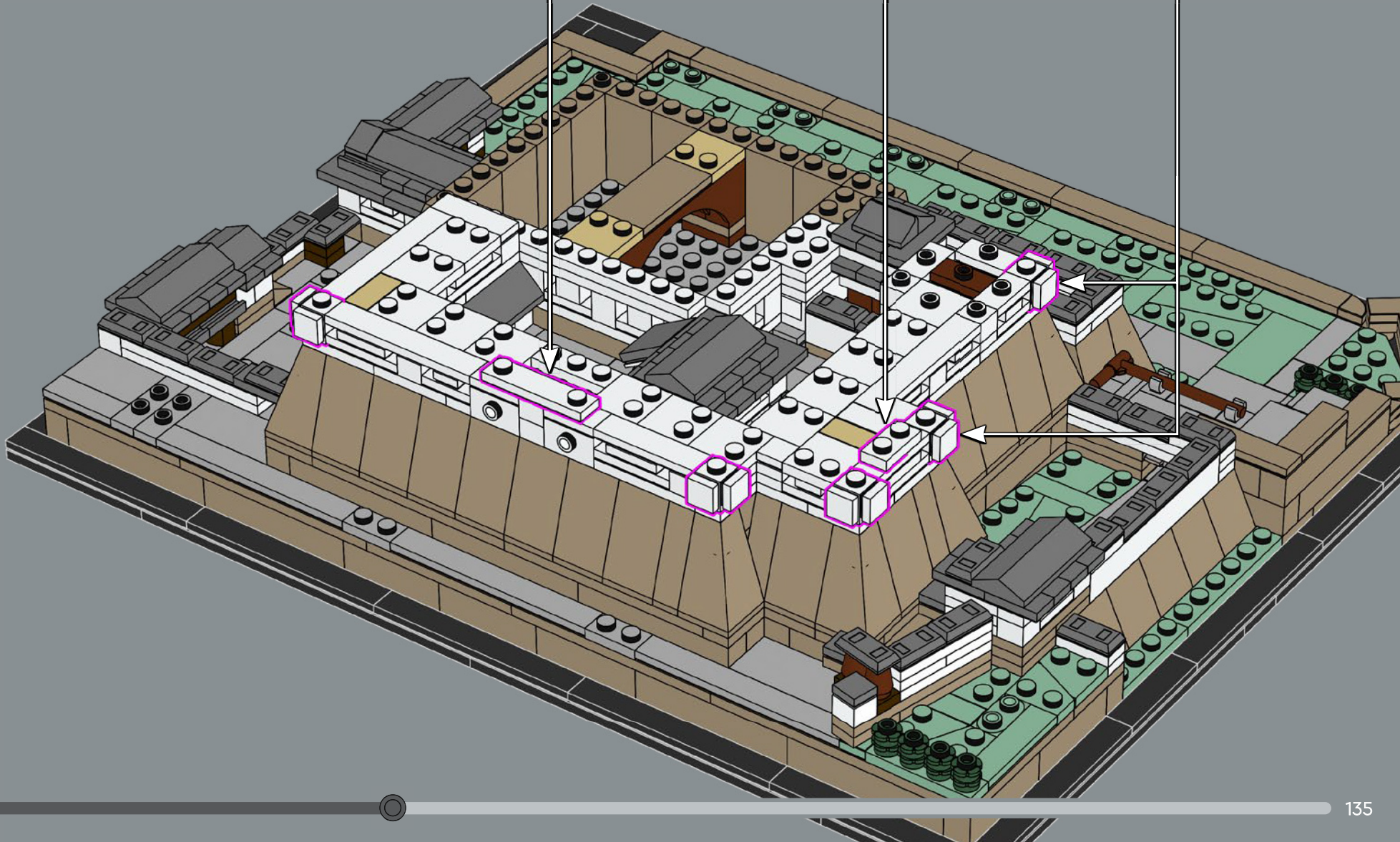
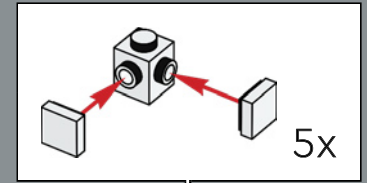
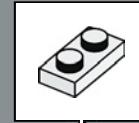
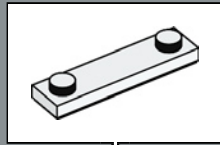

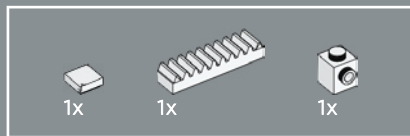

194

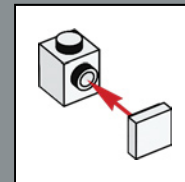
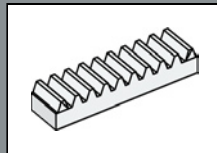

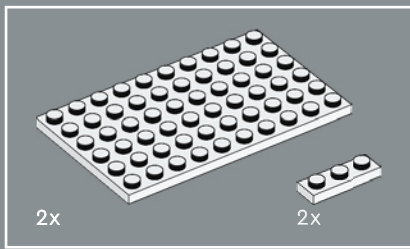

195



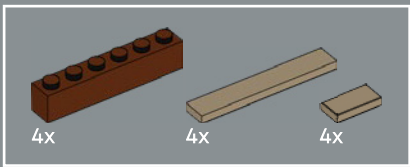

196

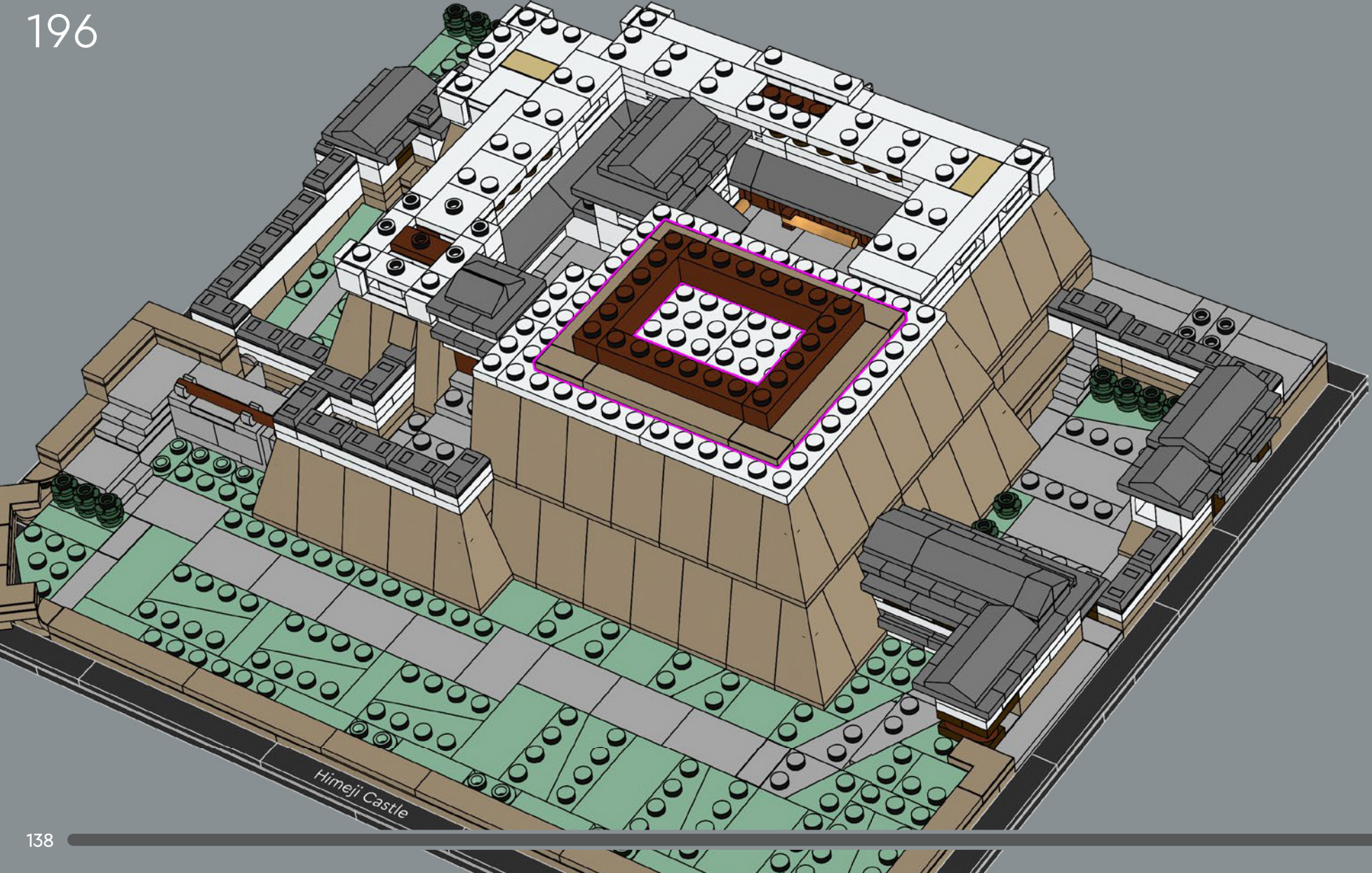

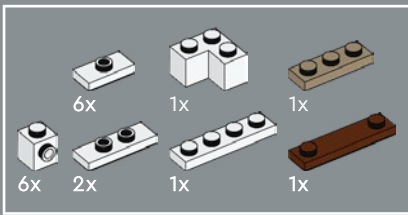

197

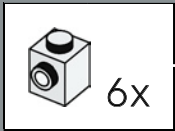
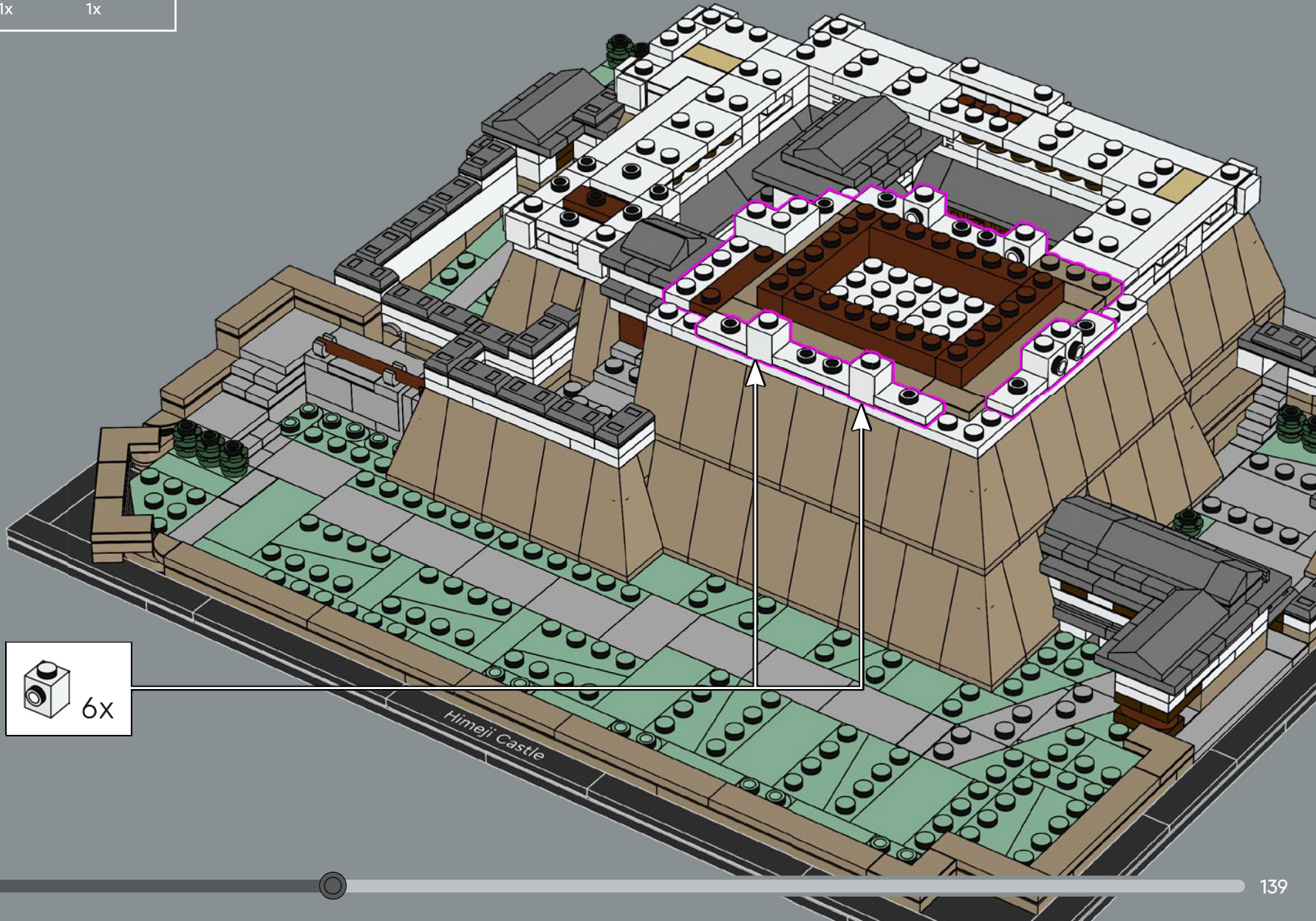

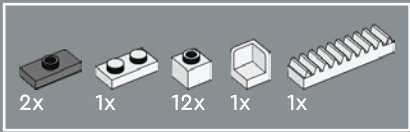

198

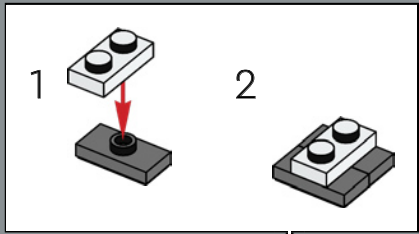

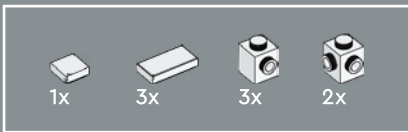

199

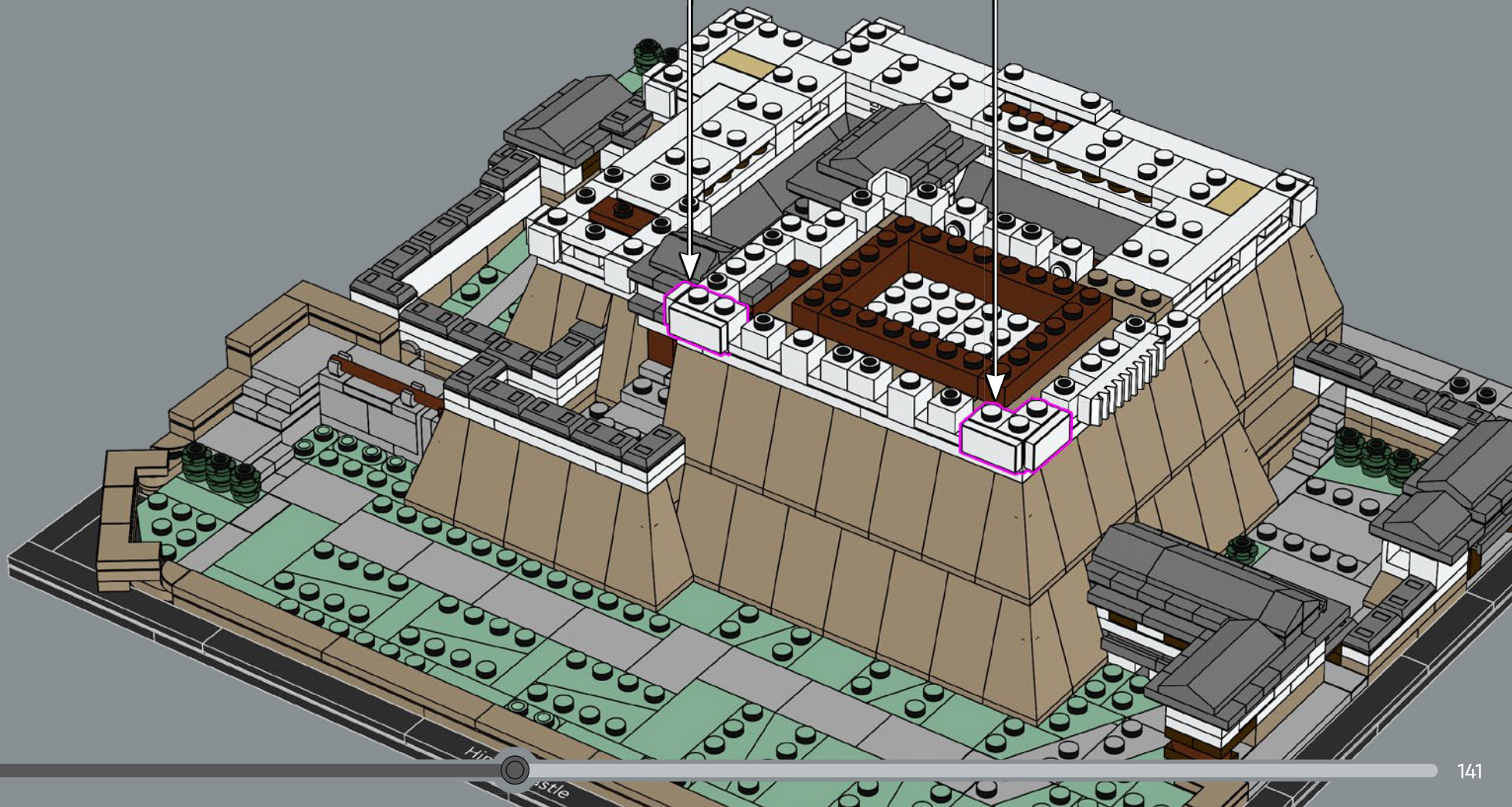
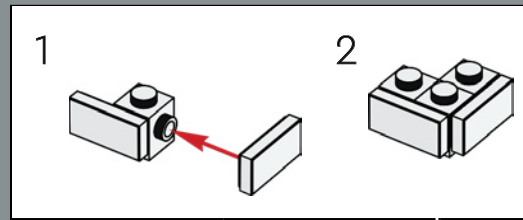
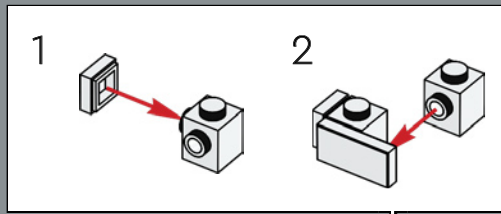

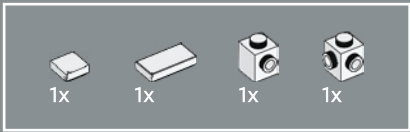

200

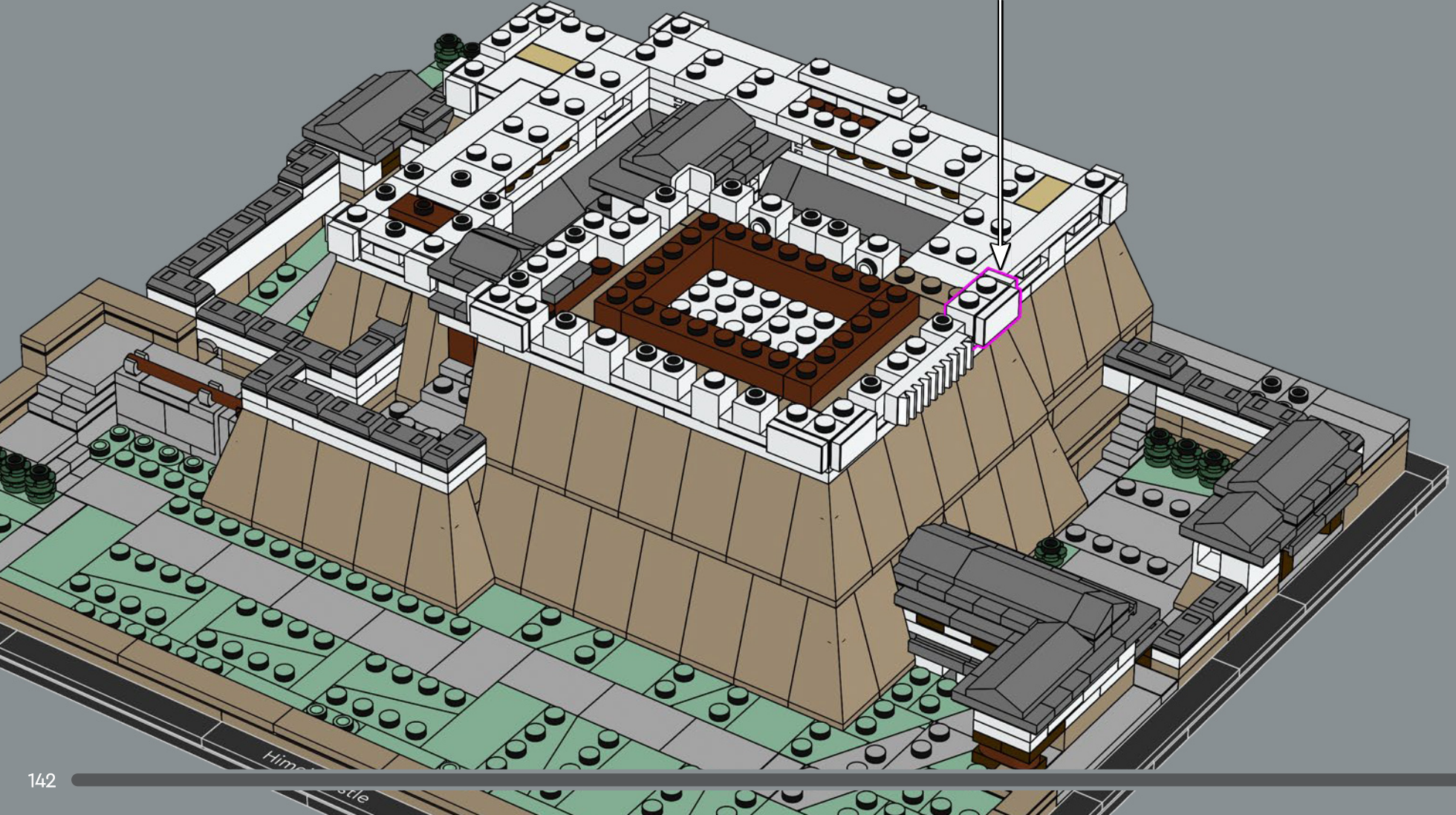
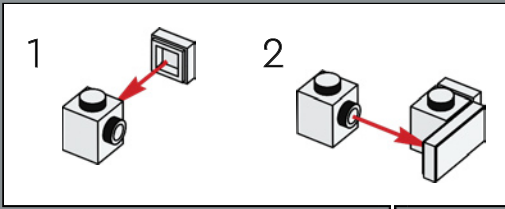

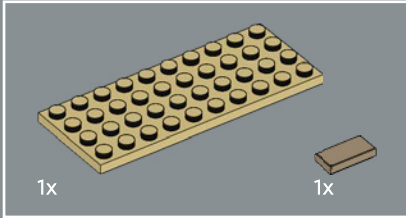
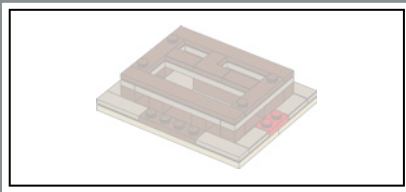

201

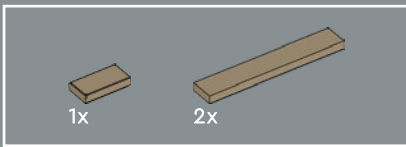
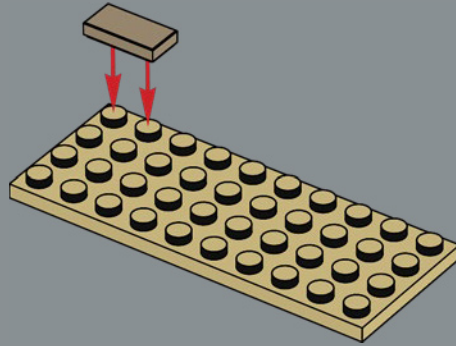

202

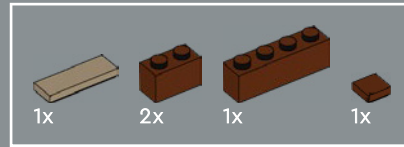
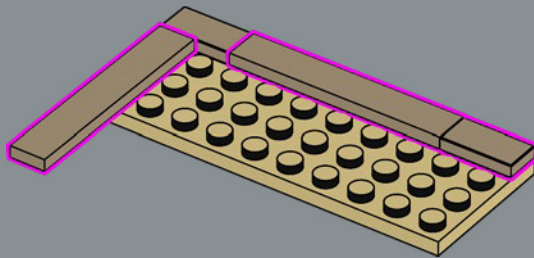

203

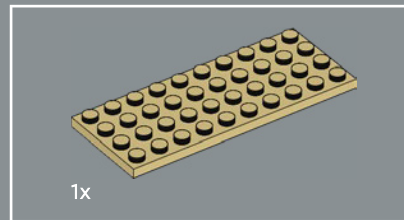
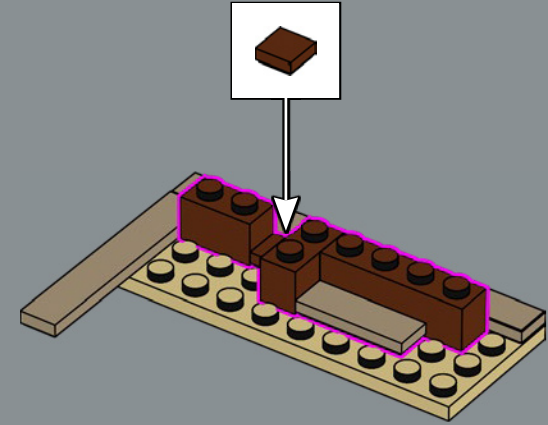

204

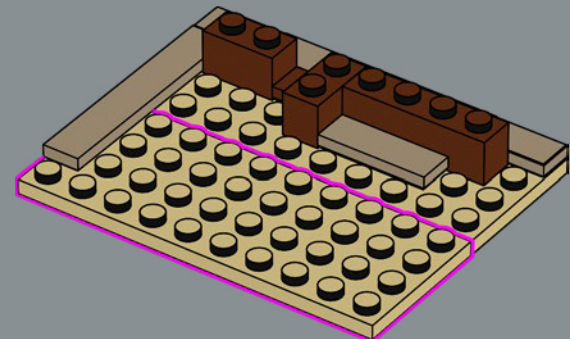

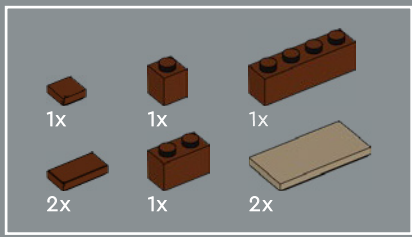

205

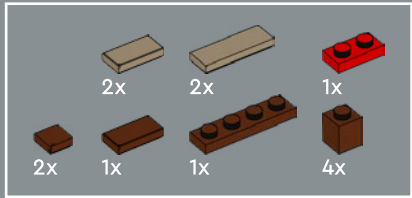
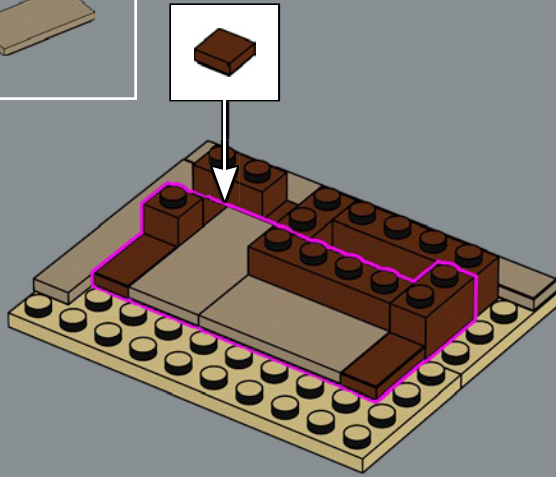

206

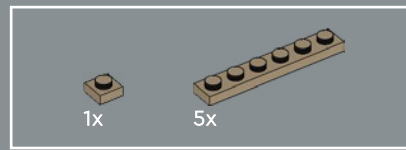
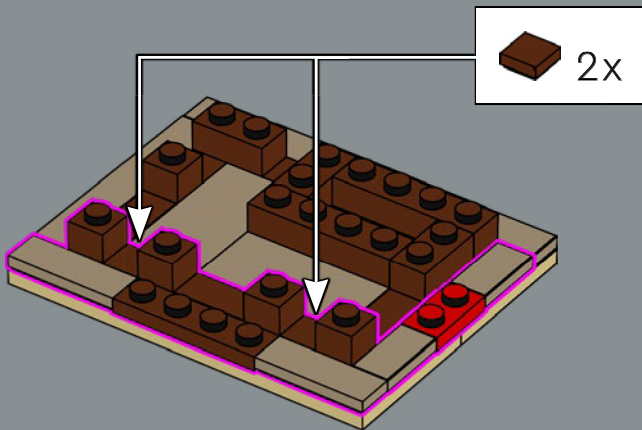

207

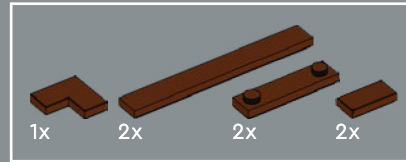
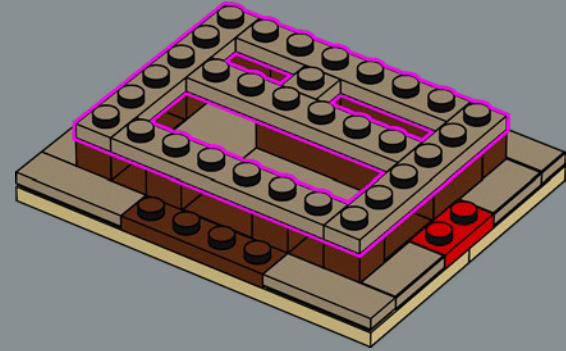

208

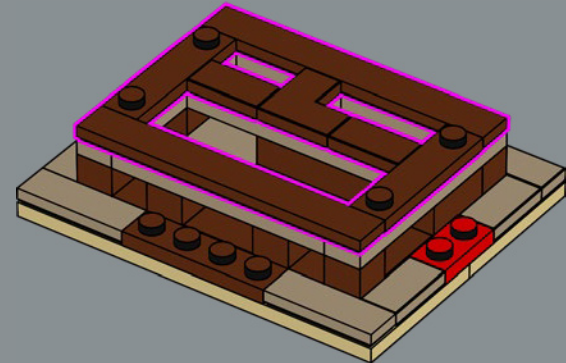

209

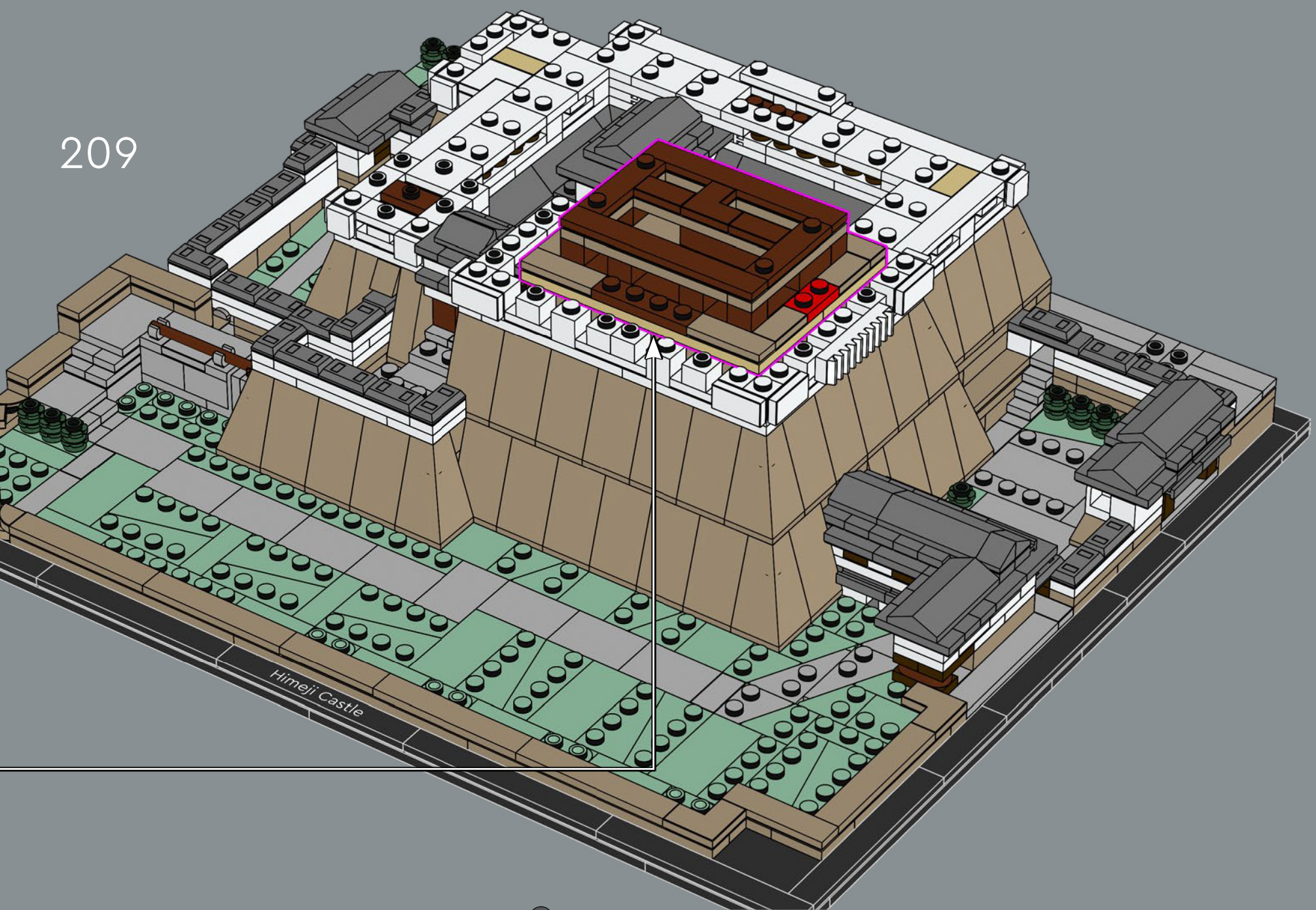

Himeji Castle

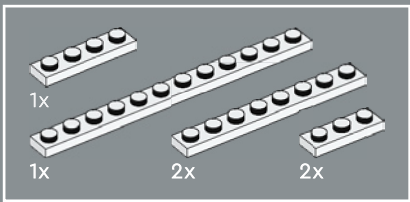

210

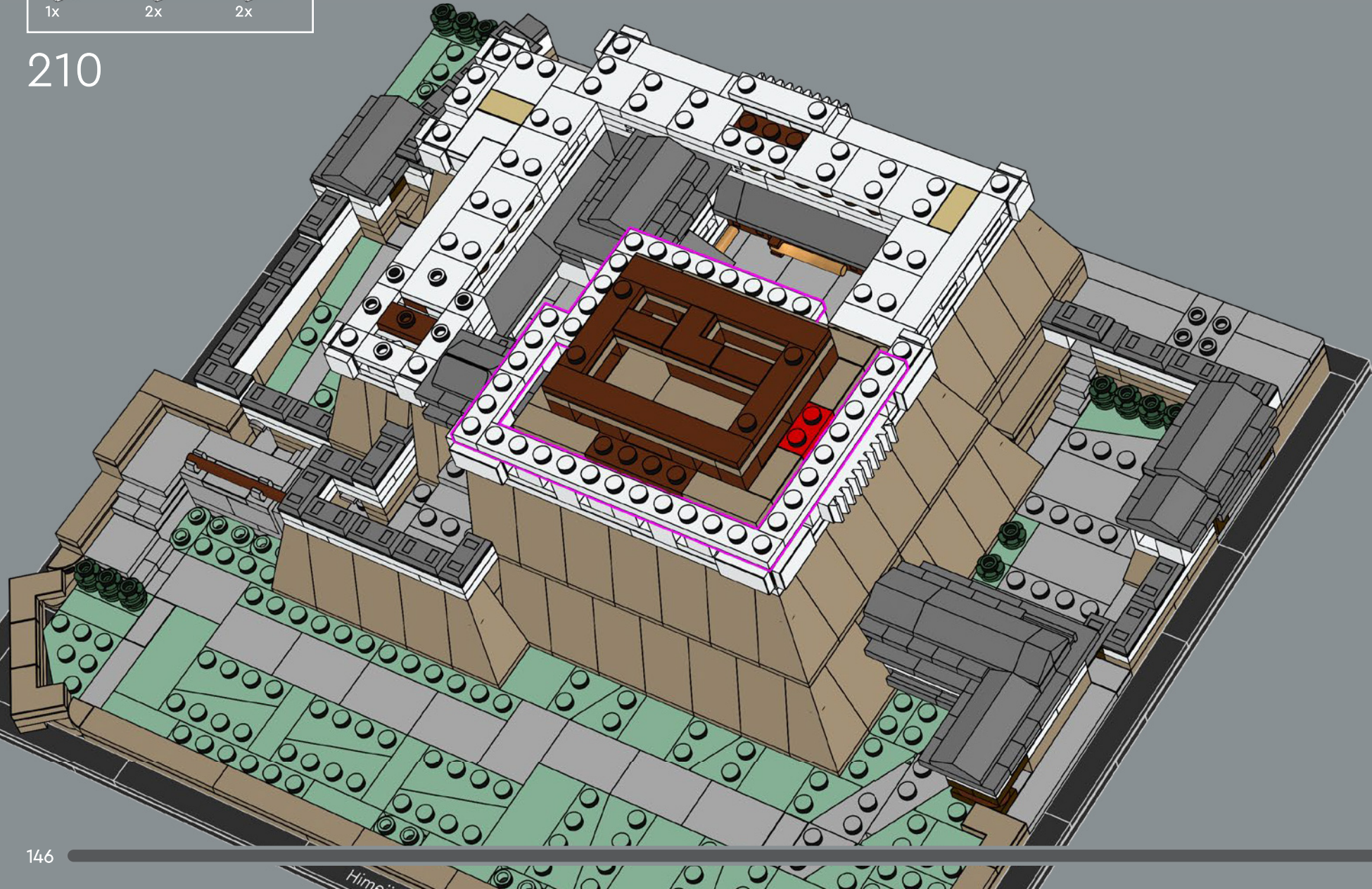



Though we had to adhere to 90-degree or other manageable angles for this set, we have kept some of the asymmetrical lines to honor the original castle.

Bien que nous ayons dû respecter des angles de 90 degrés ou d'autres angles gérables pour cet ensemble, nous avons conservé certaines des lignes asymétriques pour respecter le château original.

Aunque tuvimos que ceñir el set a los ángulos que fuera posible replicar con bricks (de 90 grados o distintos), mantuvimos algunas de las líneas asimétricas en homenaje al castillo original.

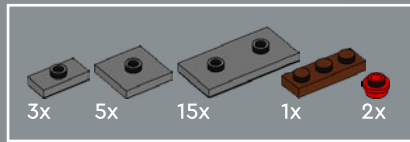

211

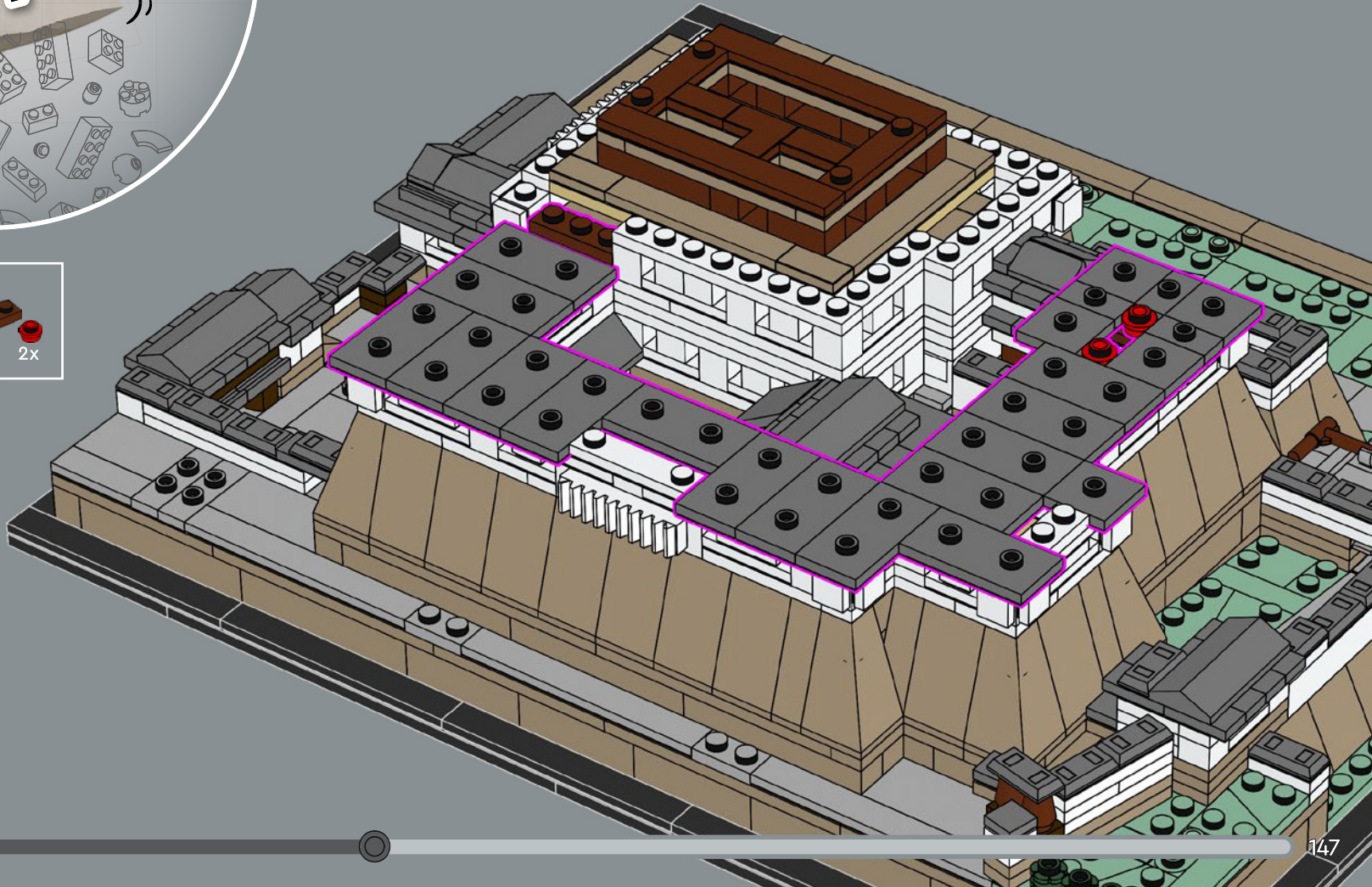

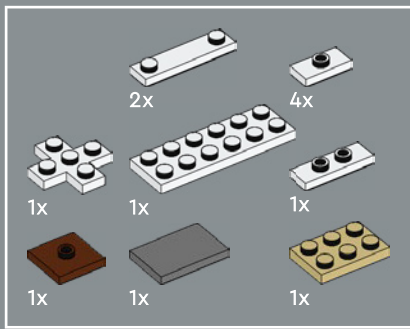

212

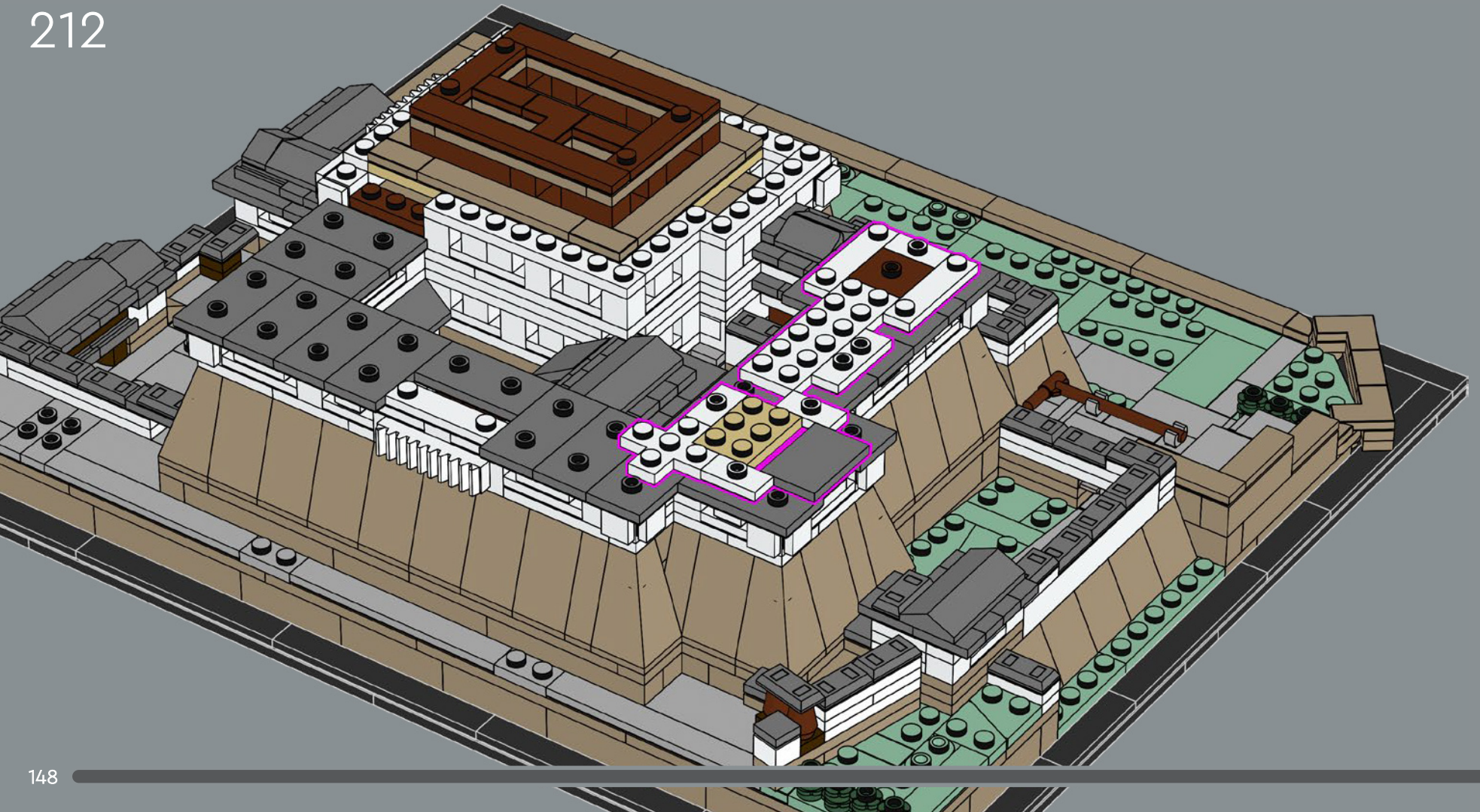

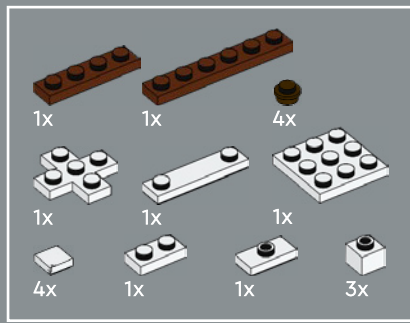

213

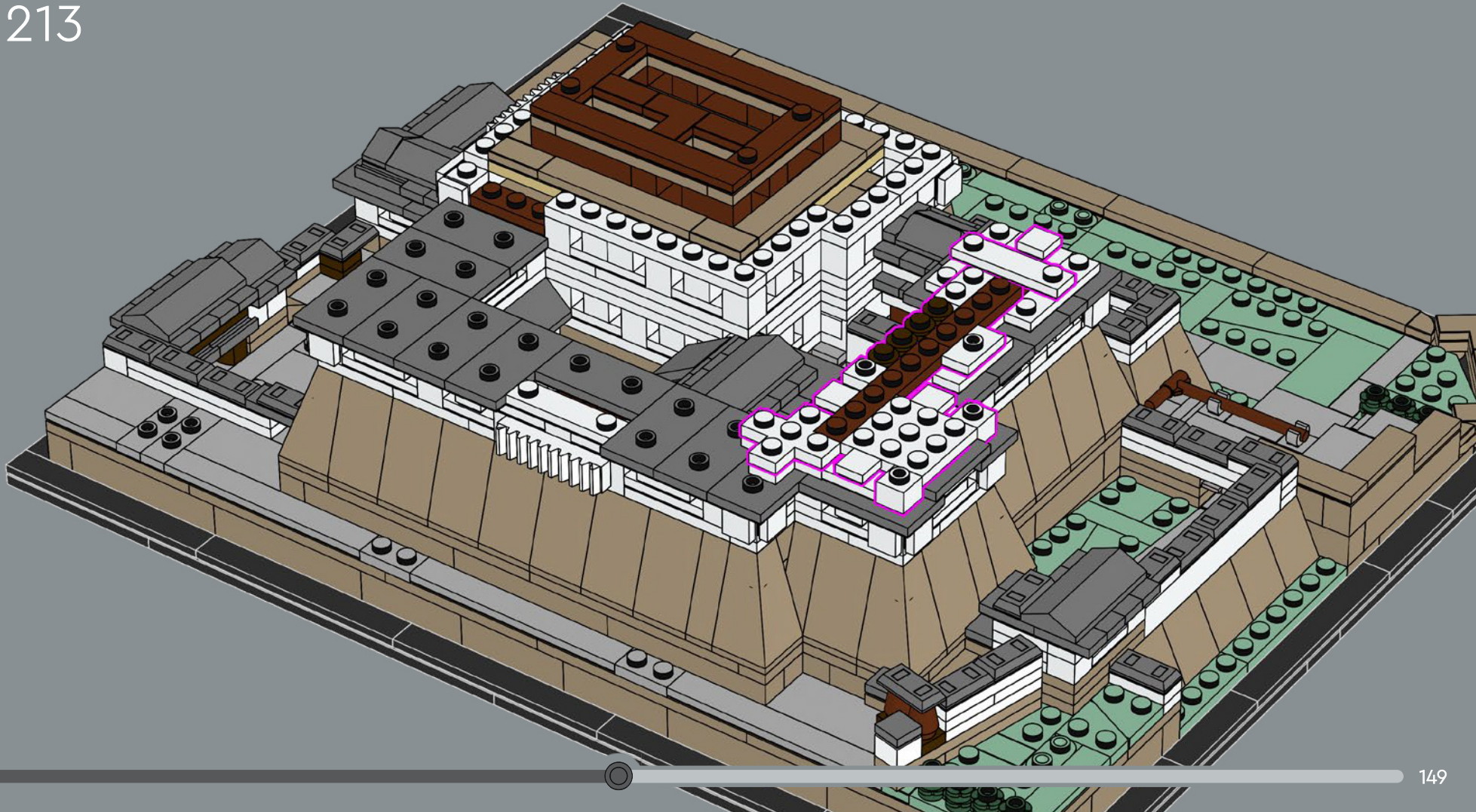

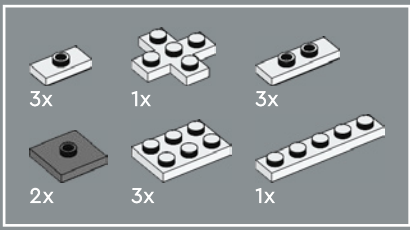

214

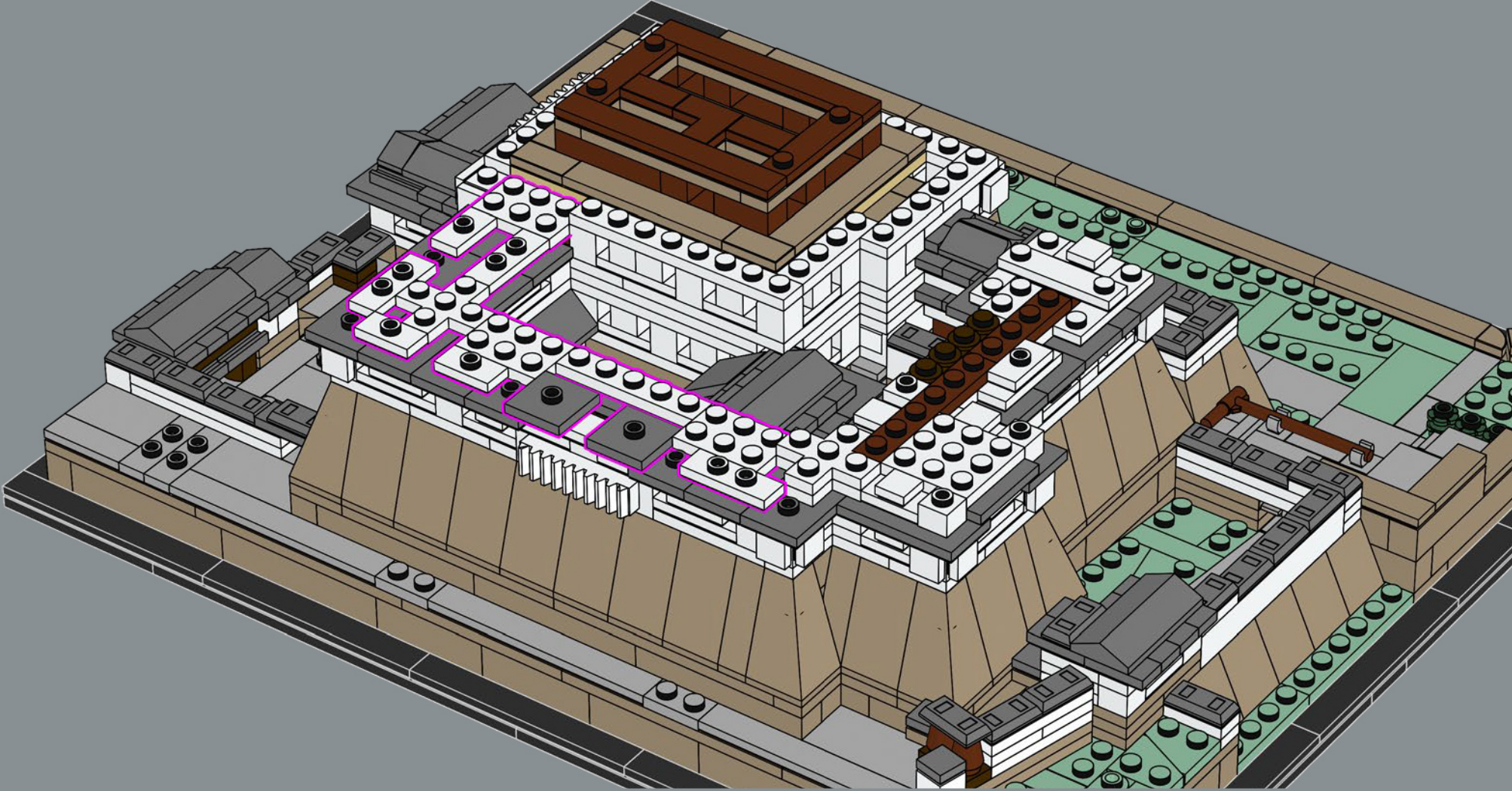

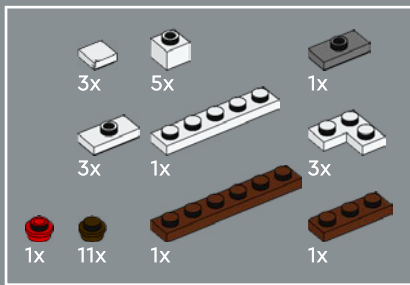

215

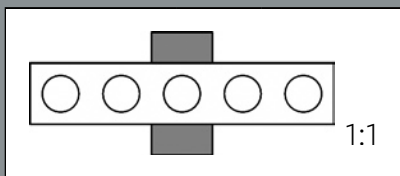
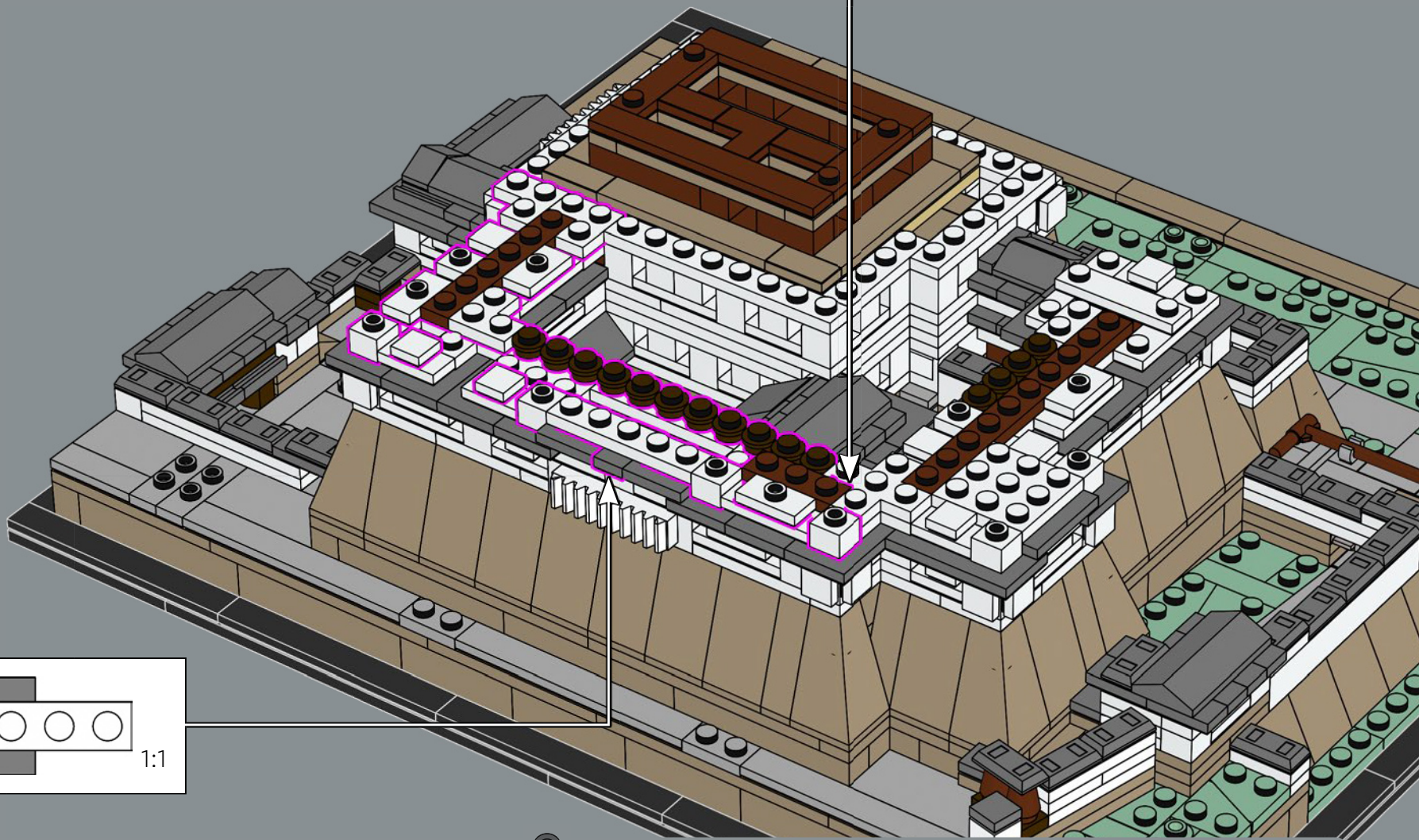
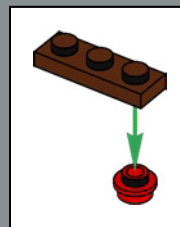

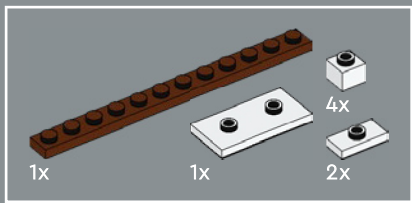

216

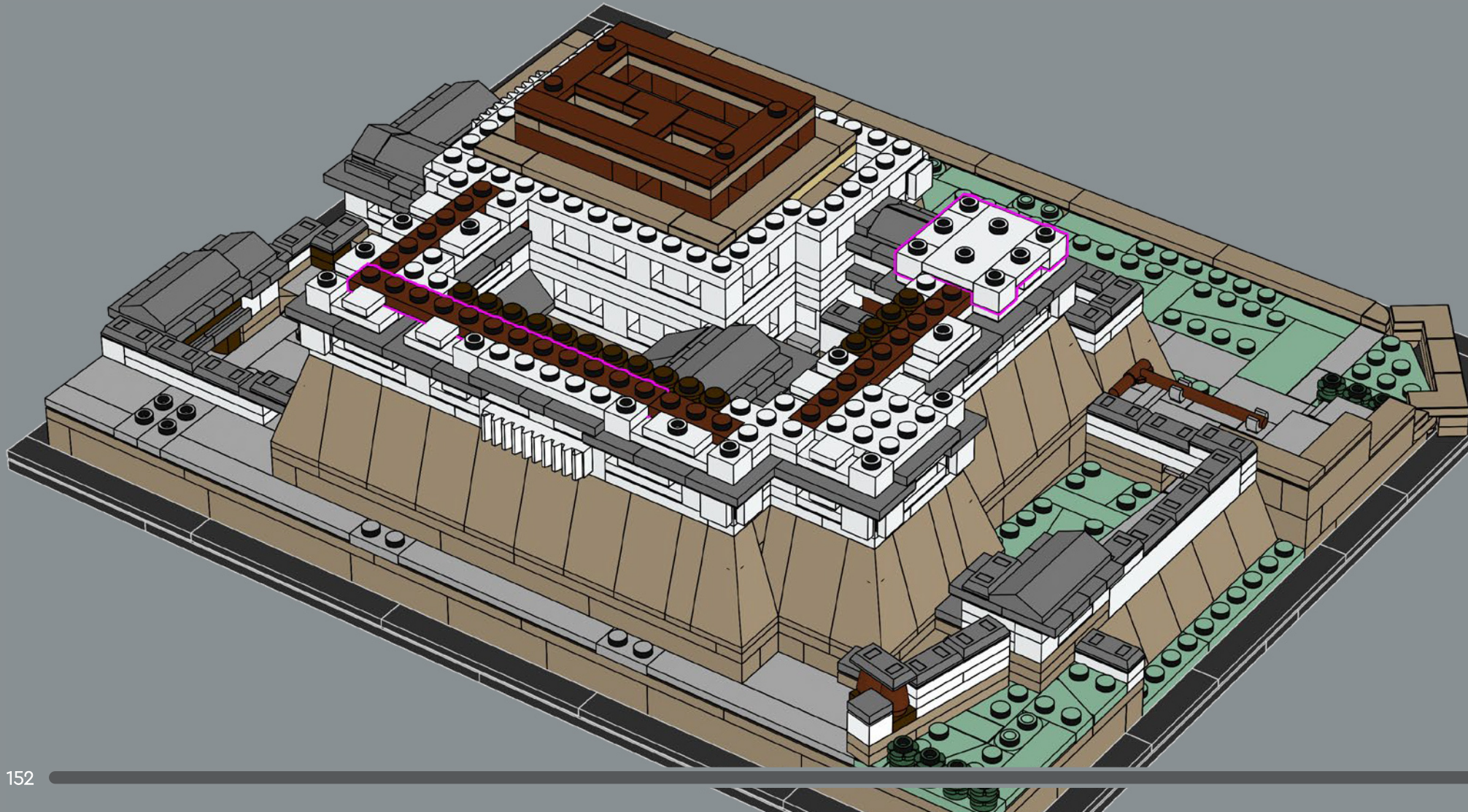

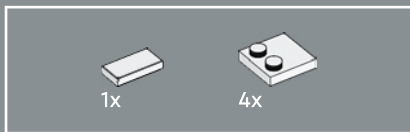

217

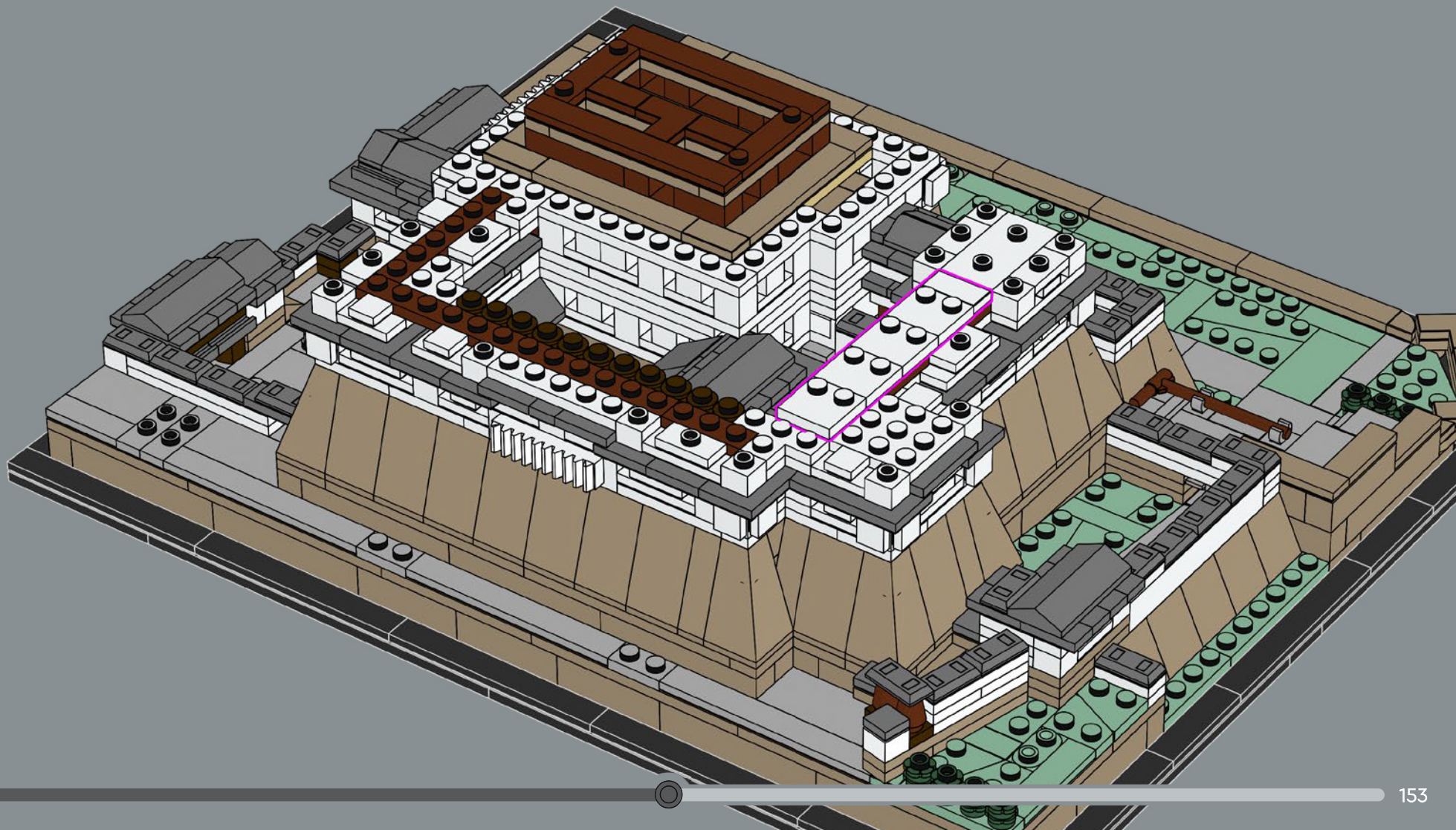

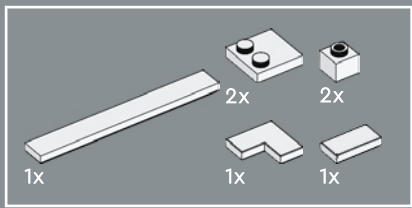

218

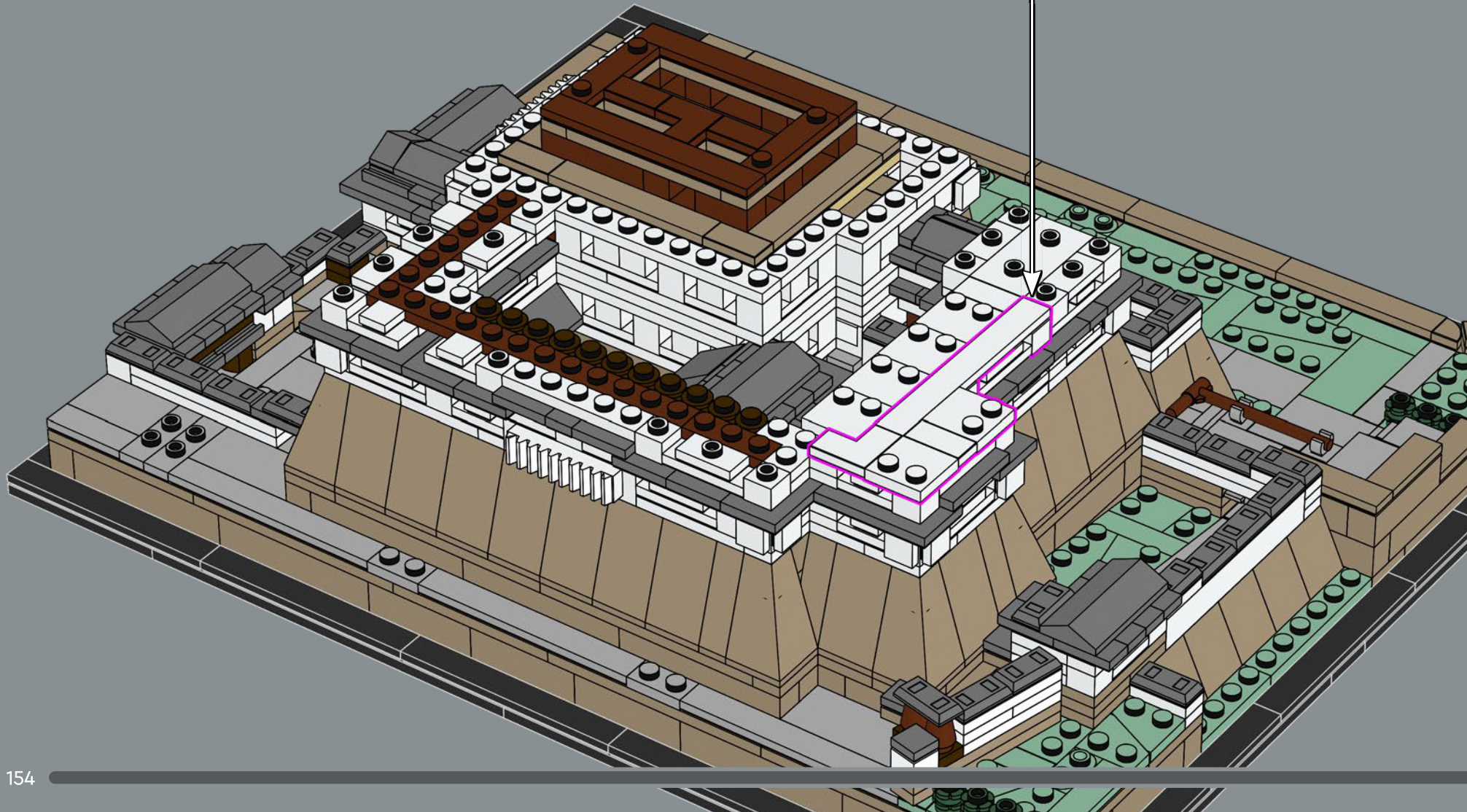
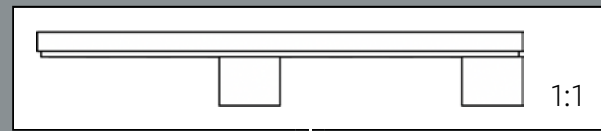

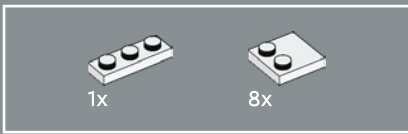

219

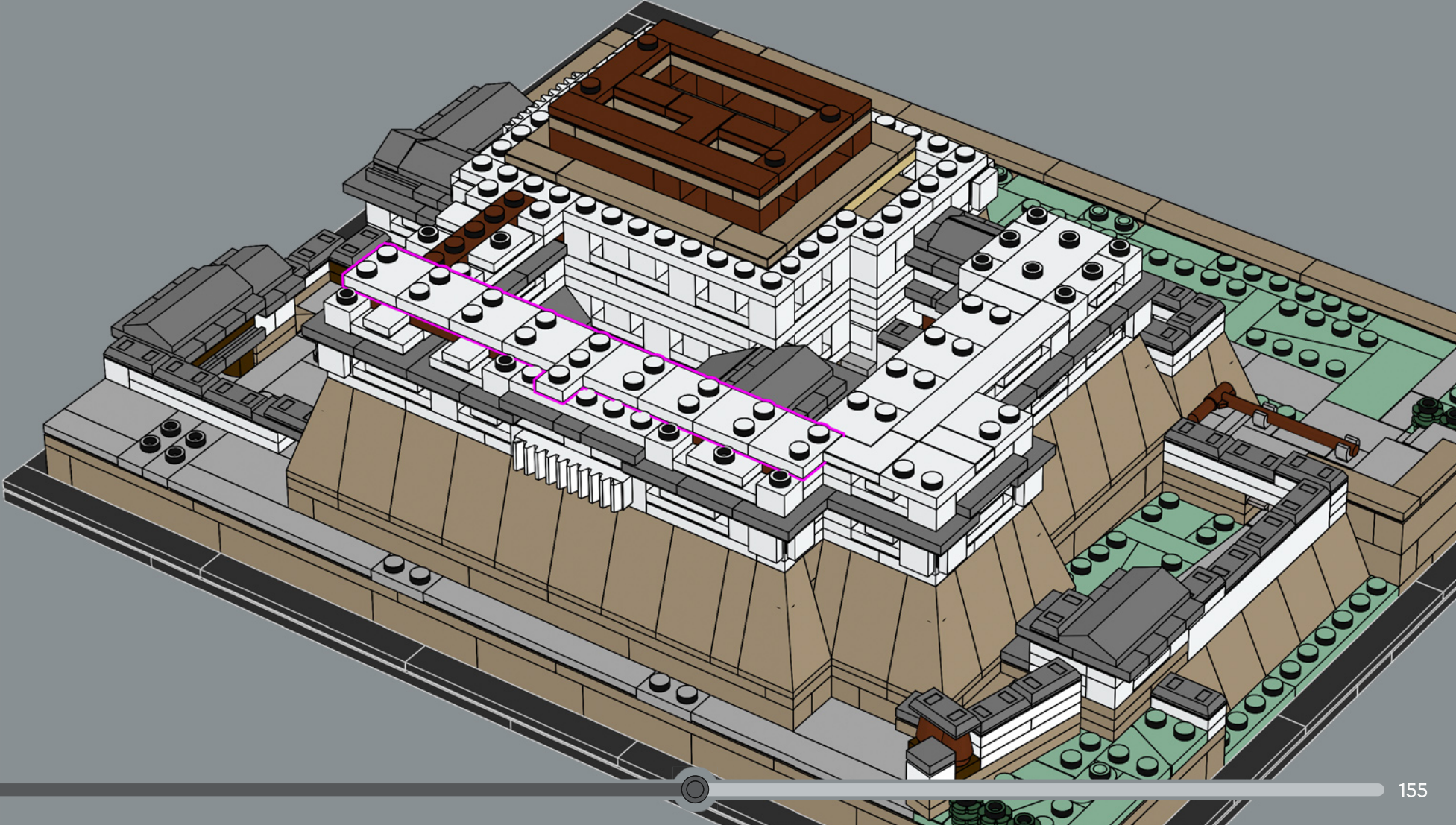

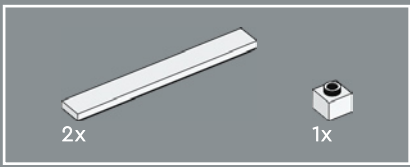

220

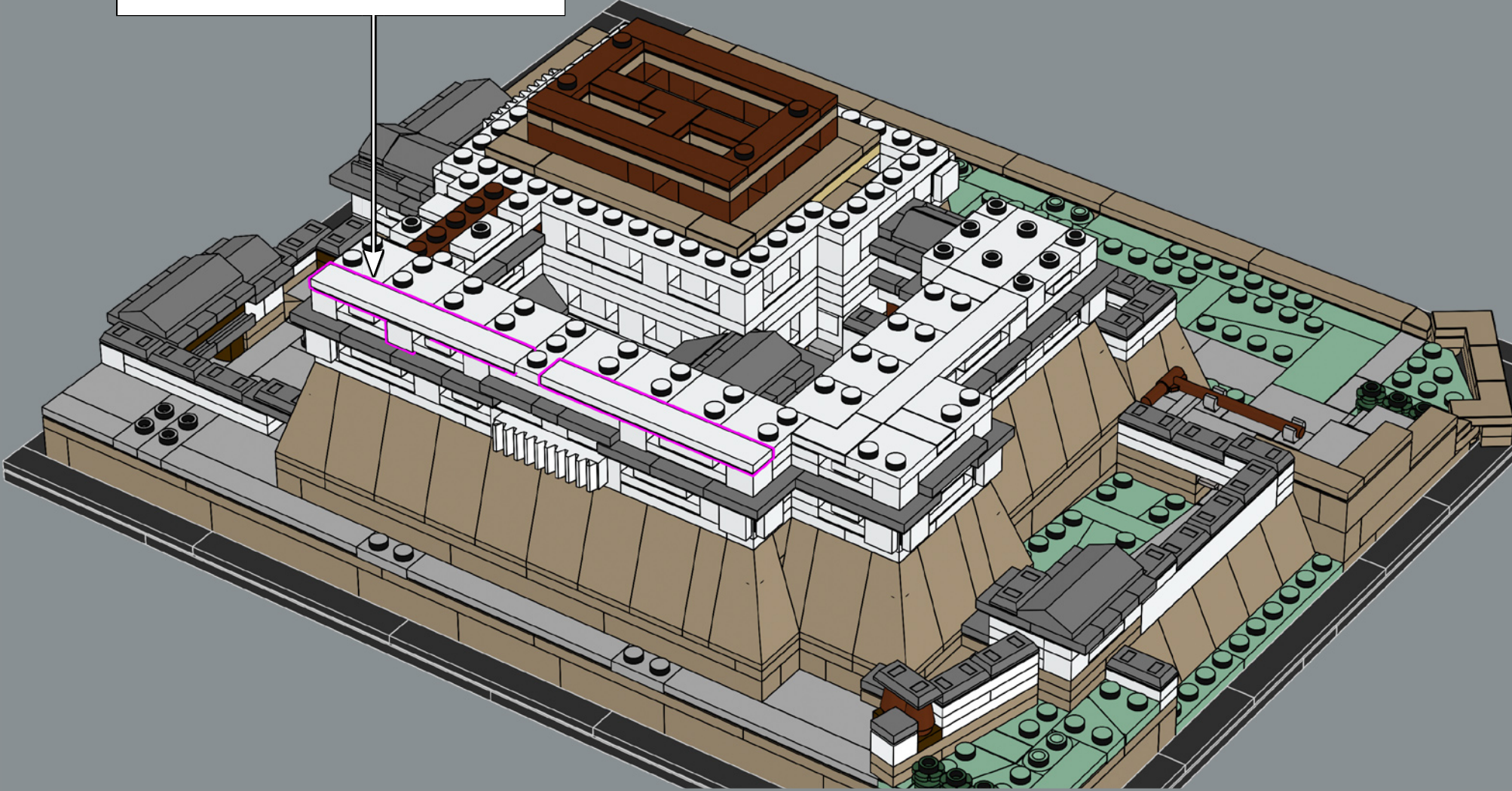
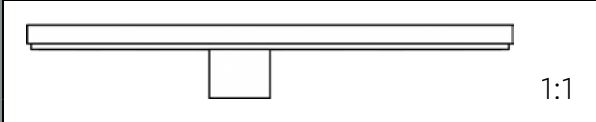

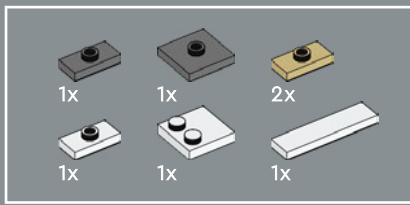

221

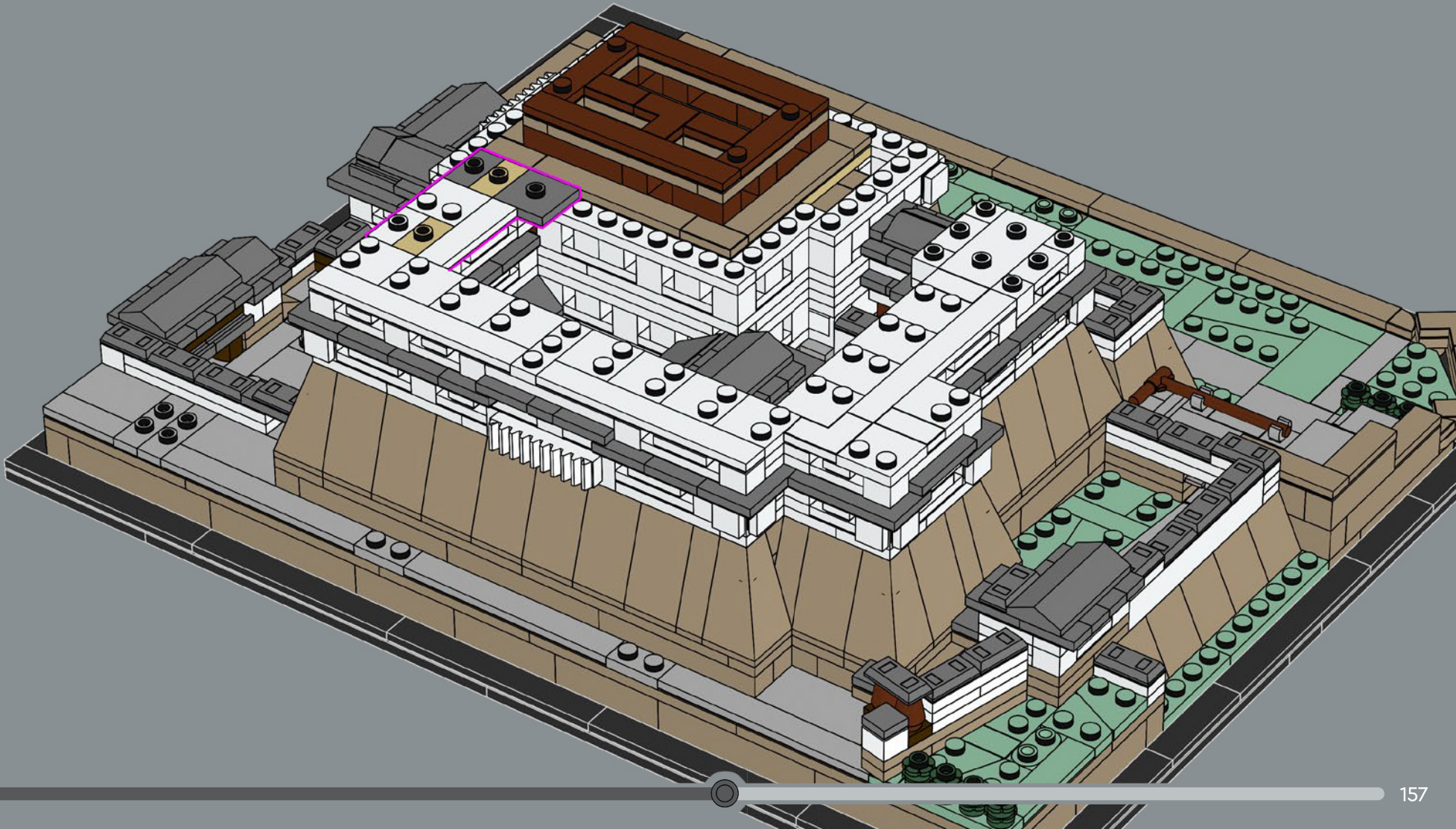

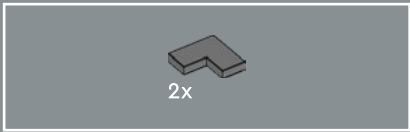

222

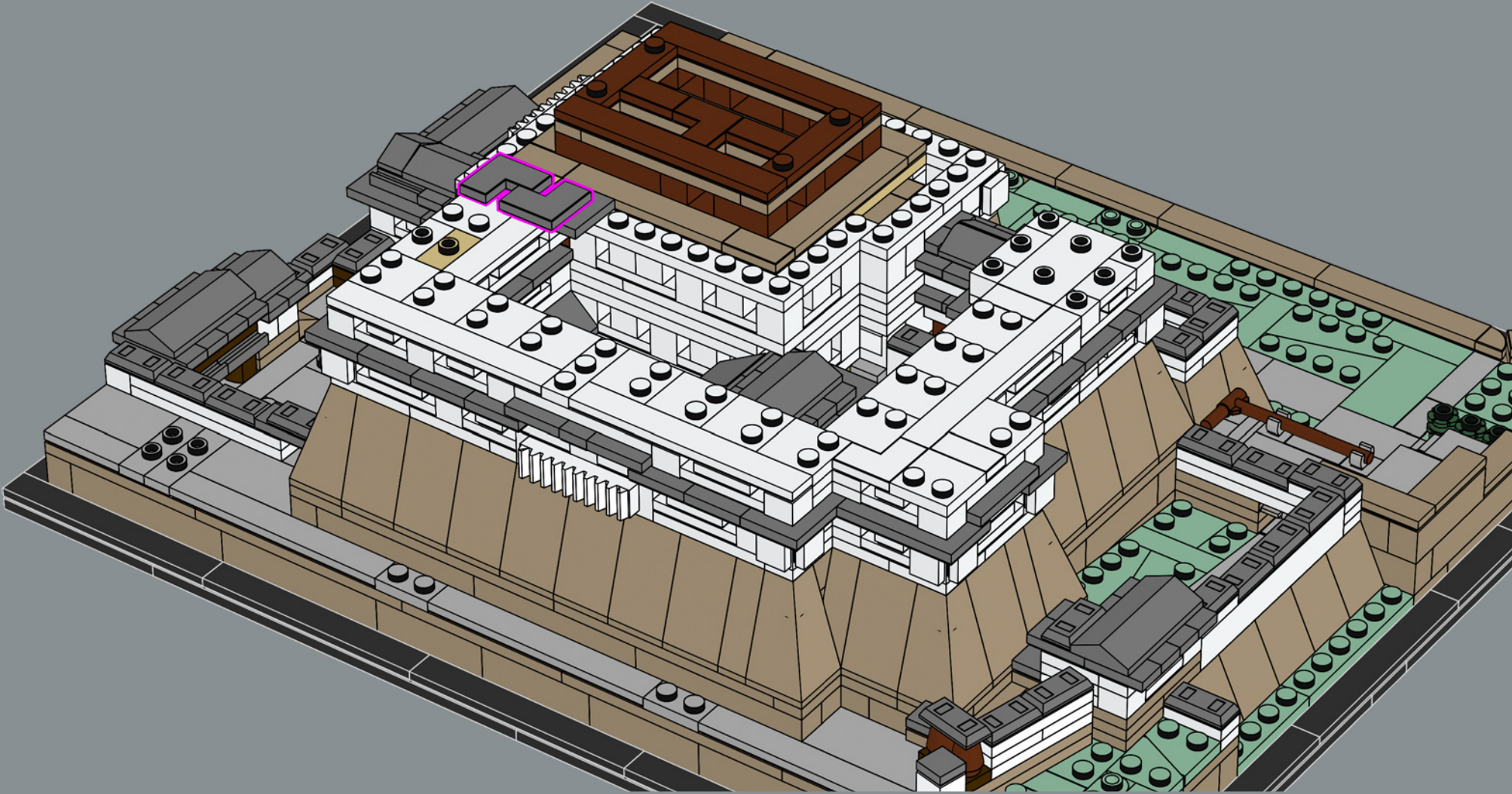

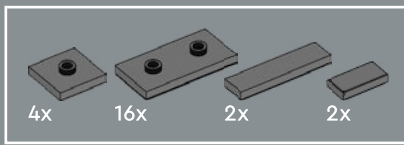

223

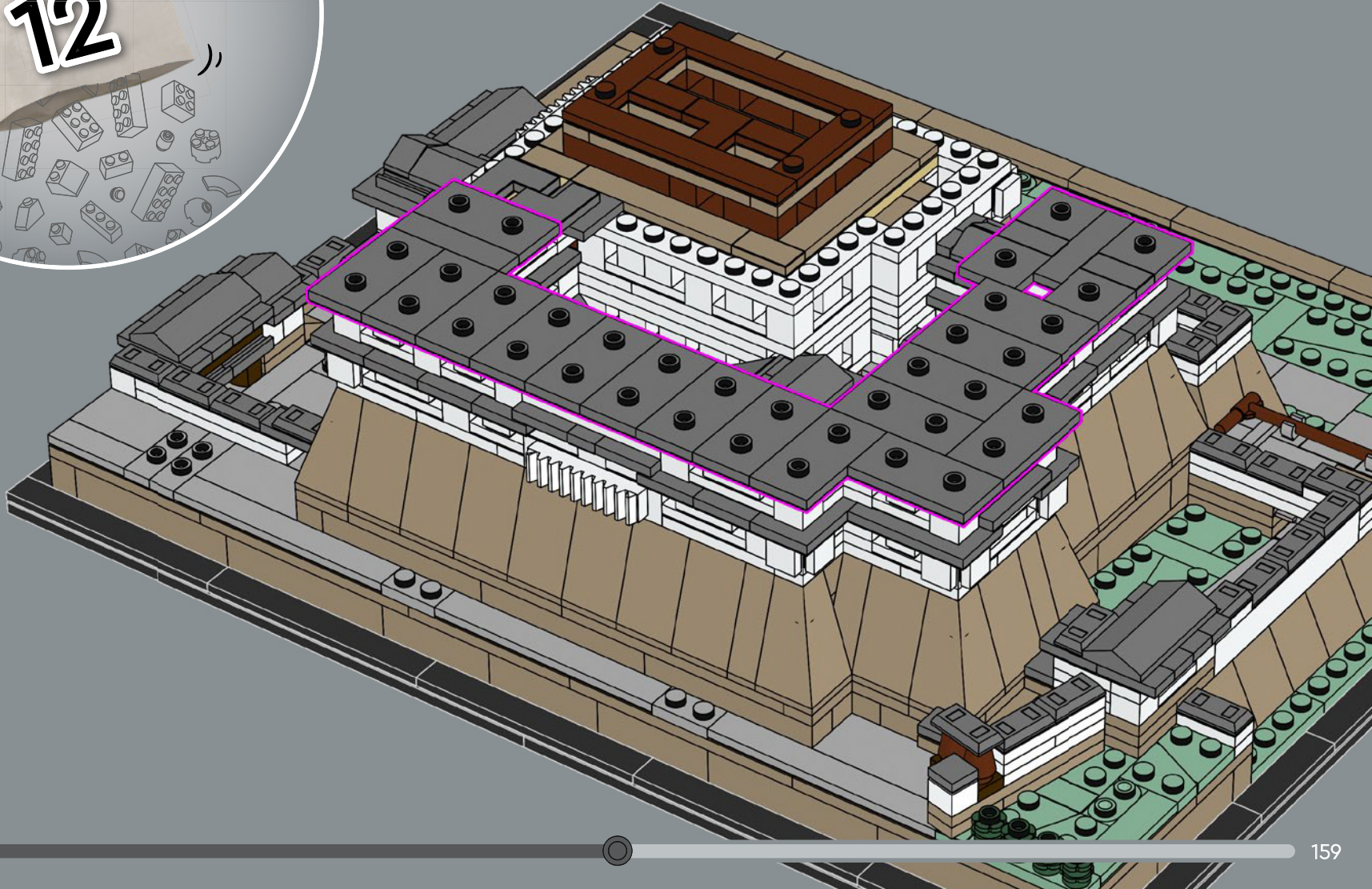

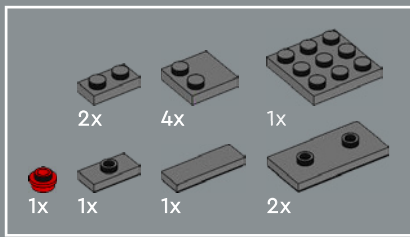

224

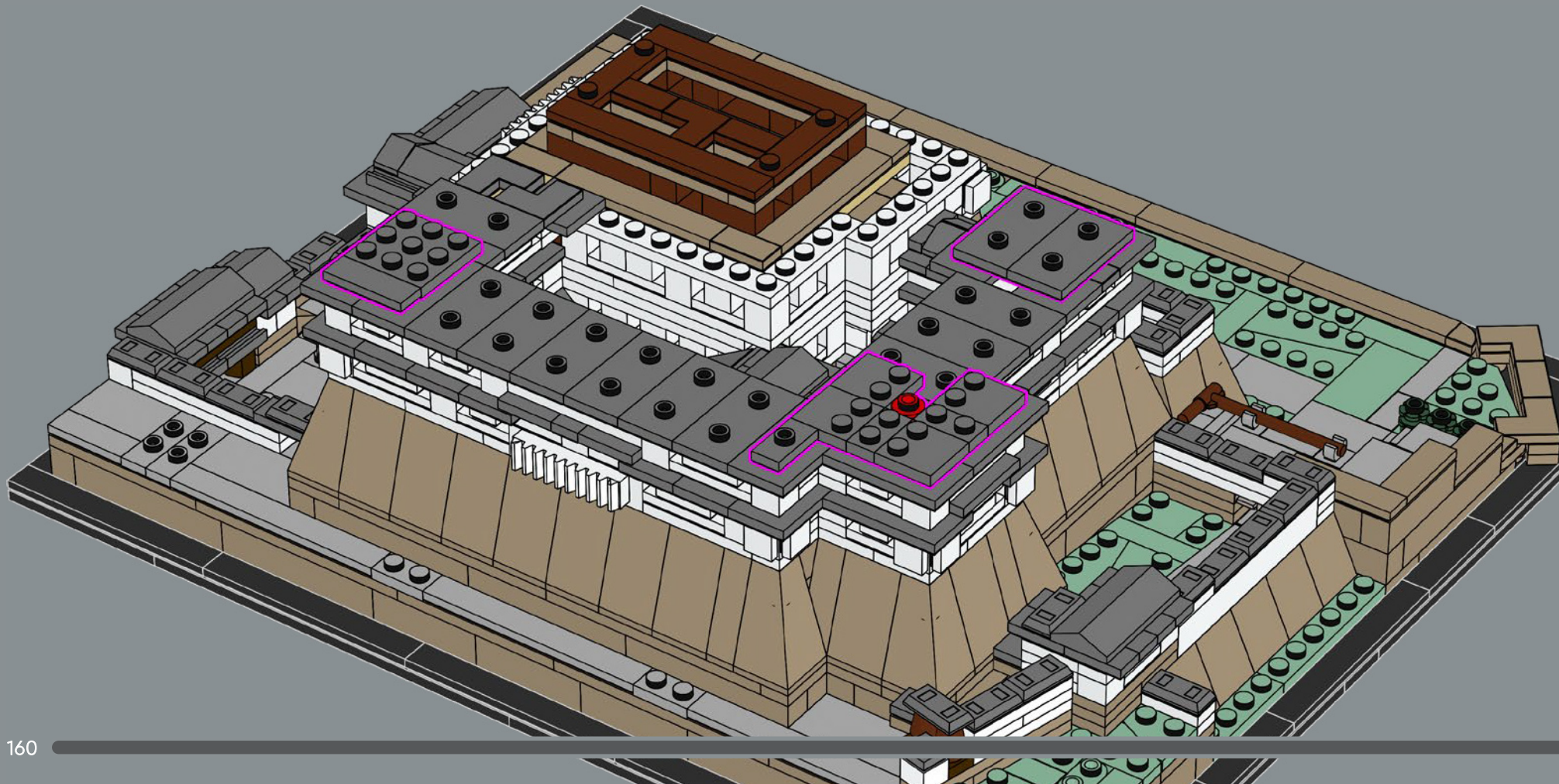

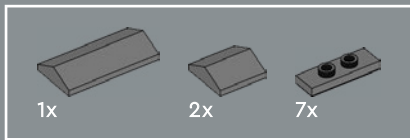

225

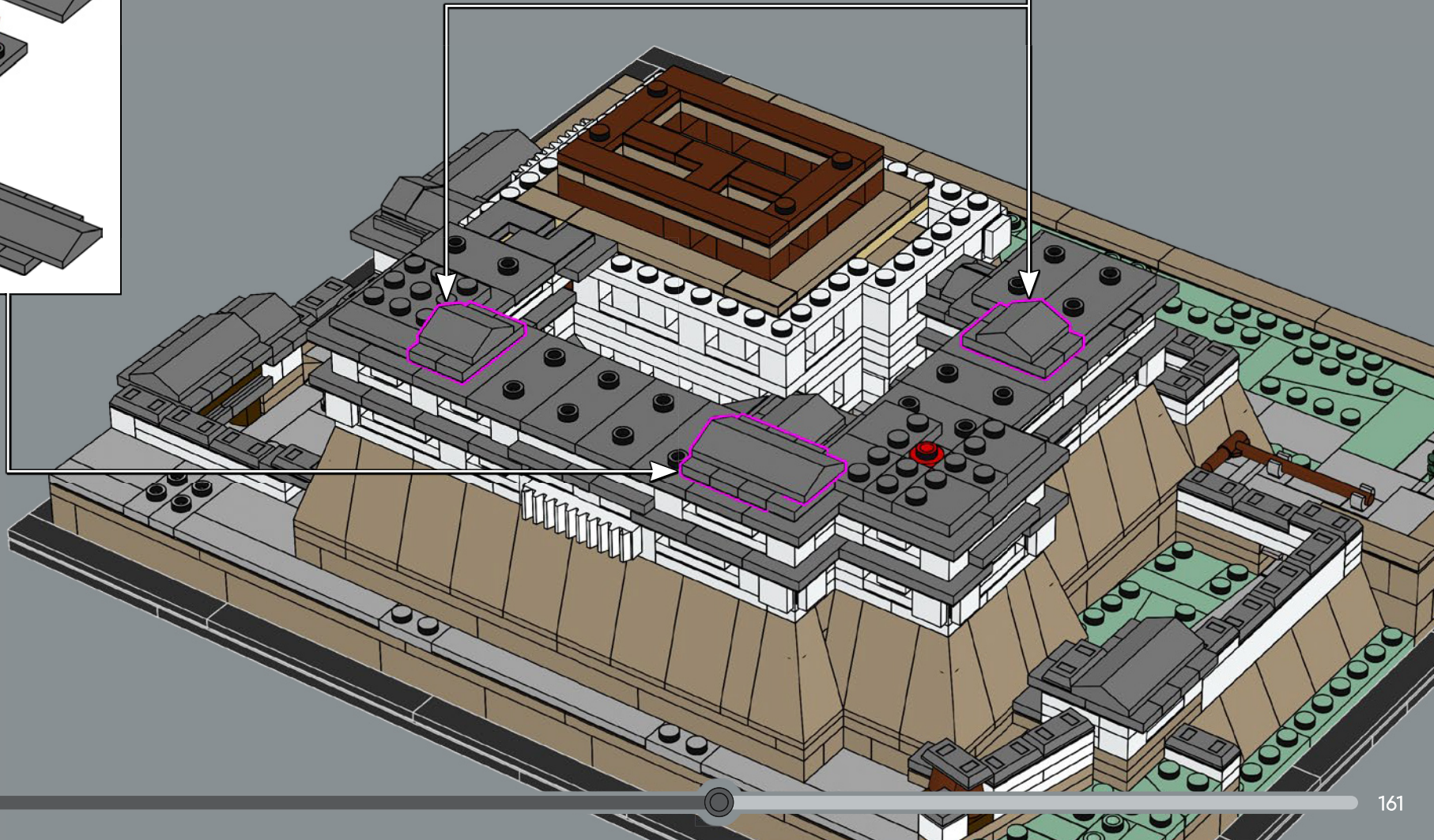
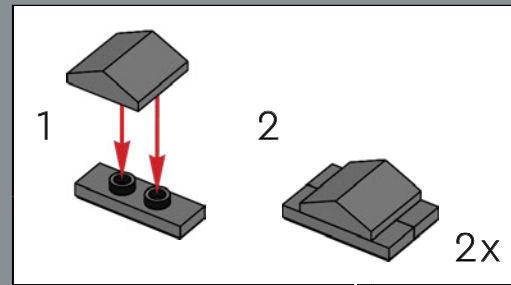
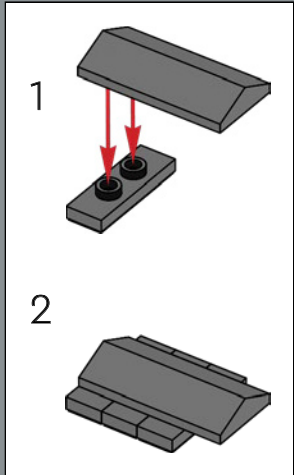

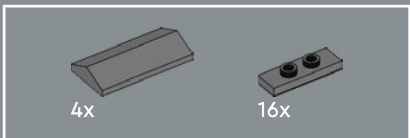

226

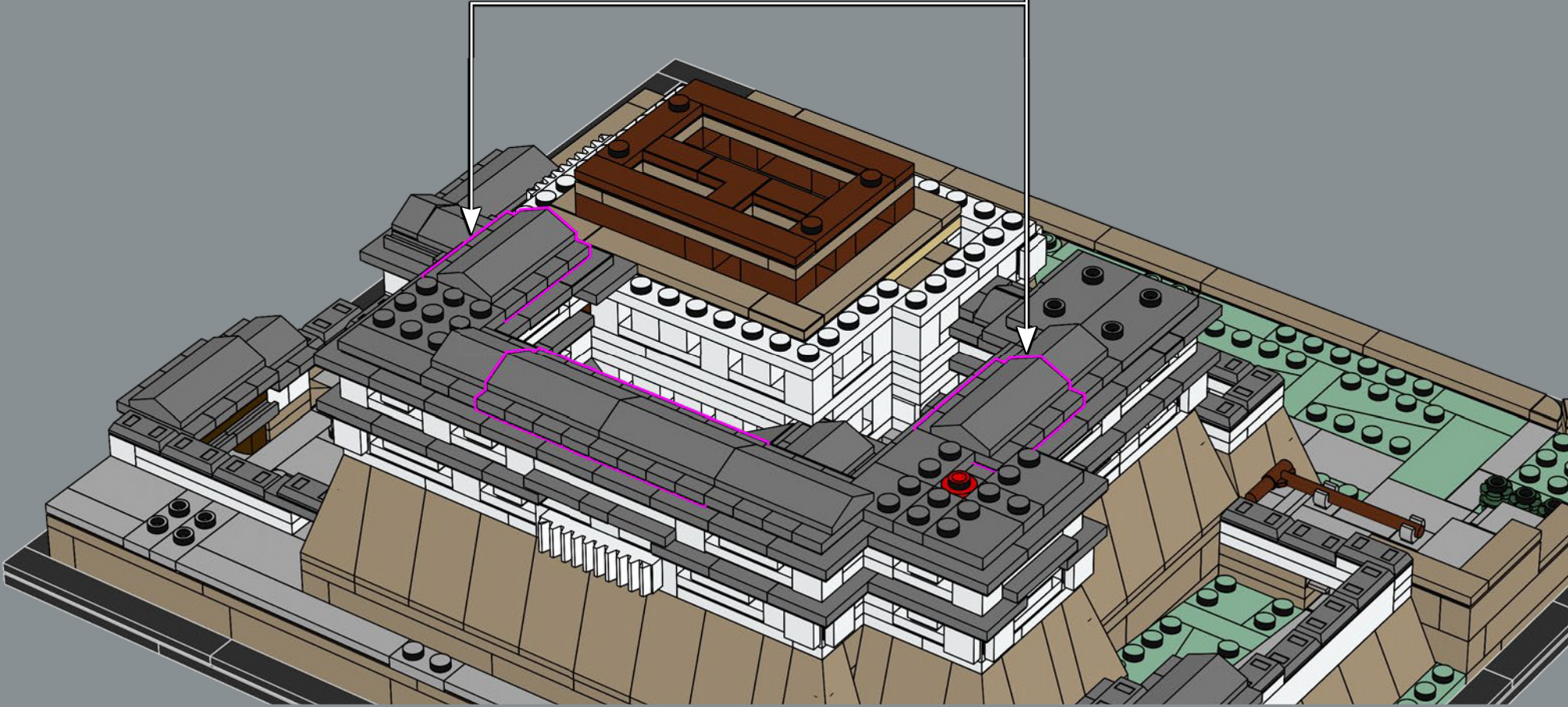
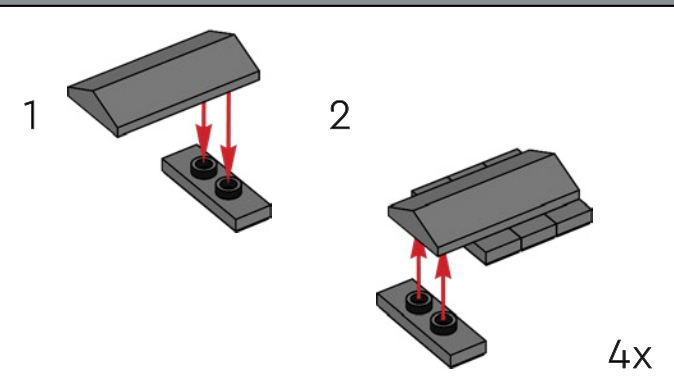

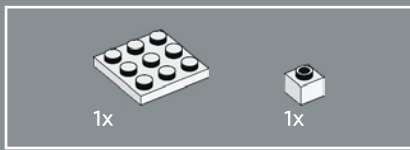

227

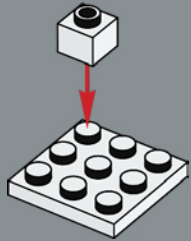

228

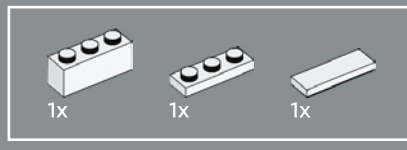
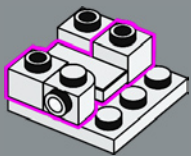

229

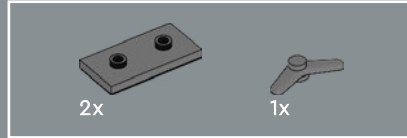
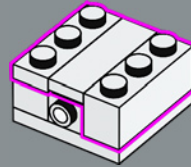

230

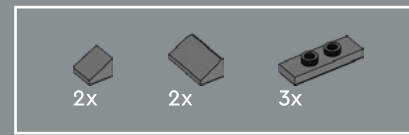
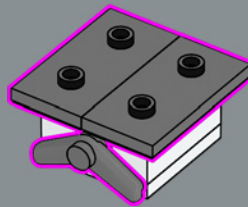

231

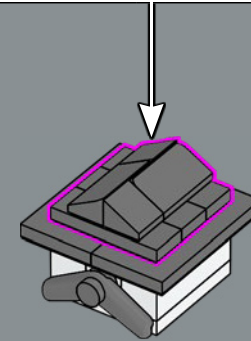
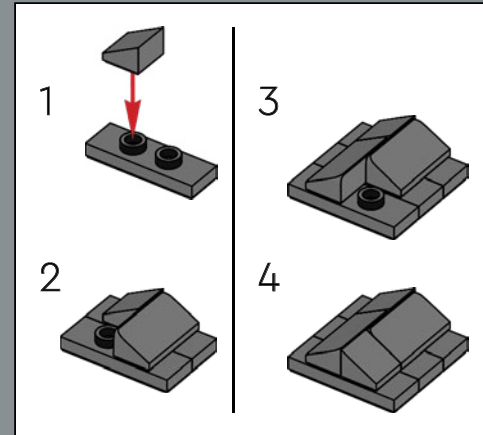

After years of exposure, the white clay on the roof starts to get dirty, slowly changing the appearance and color of the roof.

Après des années d'exposition, l'argile blanche du toit commence à être salie, ce qui altère lentement l'aspect et la couleur du toit.

Años de exposición a los elementos hacen que la arcilla blanca del techo comience a ensuciarse, lo que altera lentamente la apariencia y el color del techo.

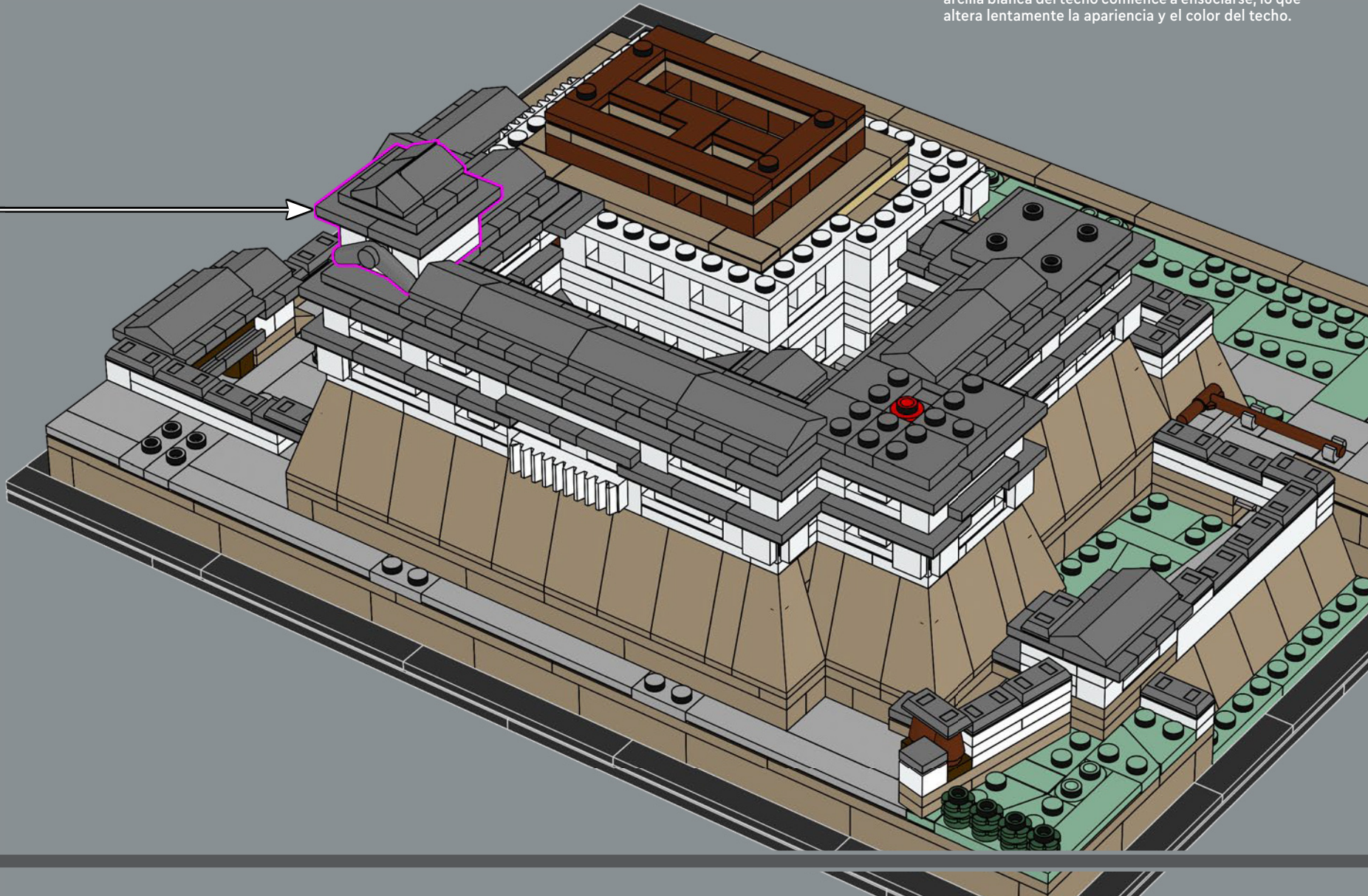

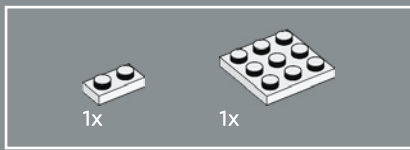

233

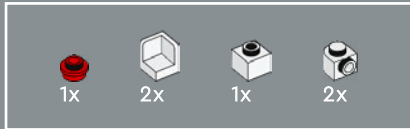
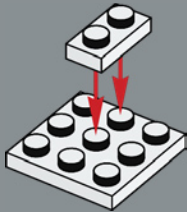

234

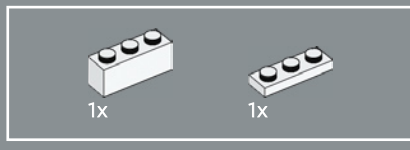
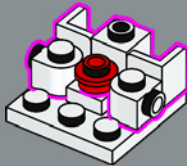

235

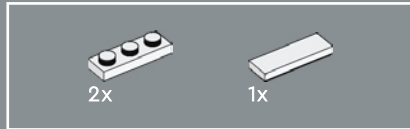
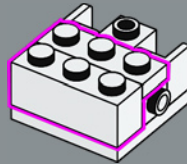

236

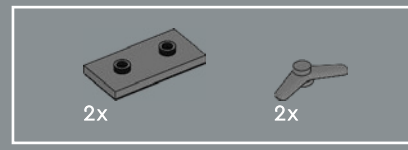
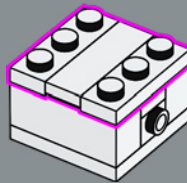

237

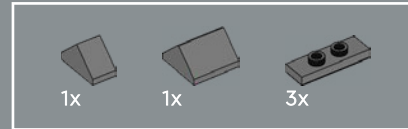
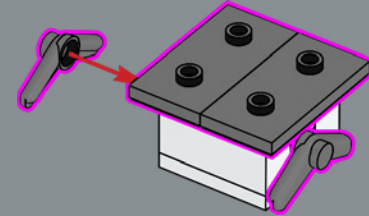

238

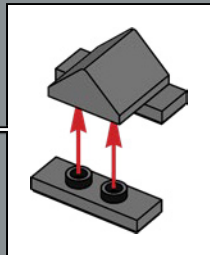
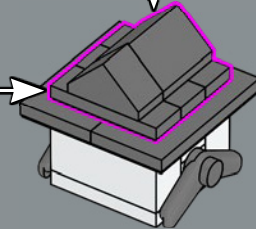
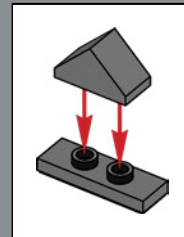

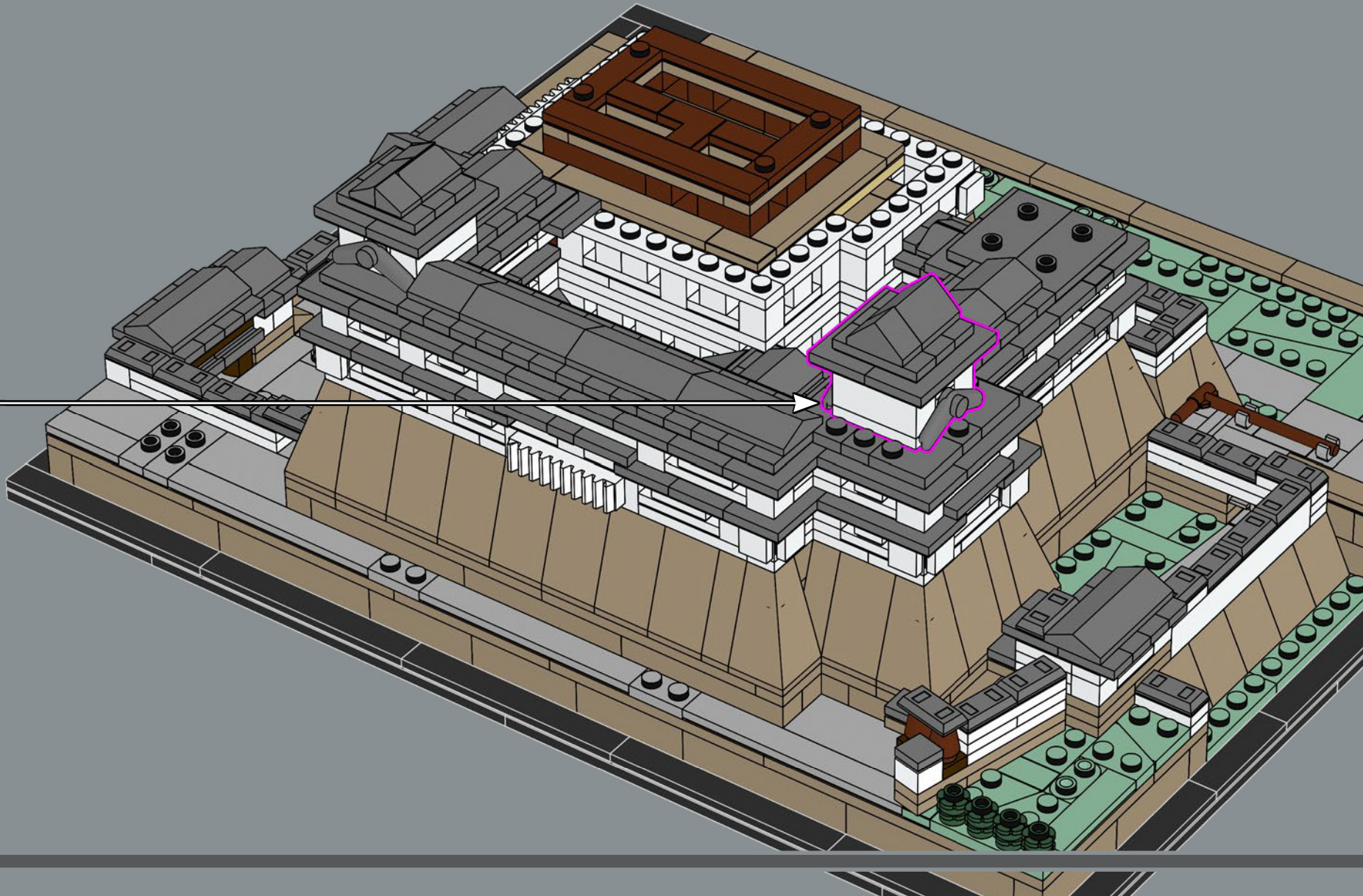



240

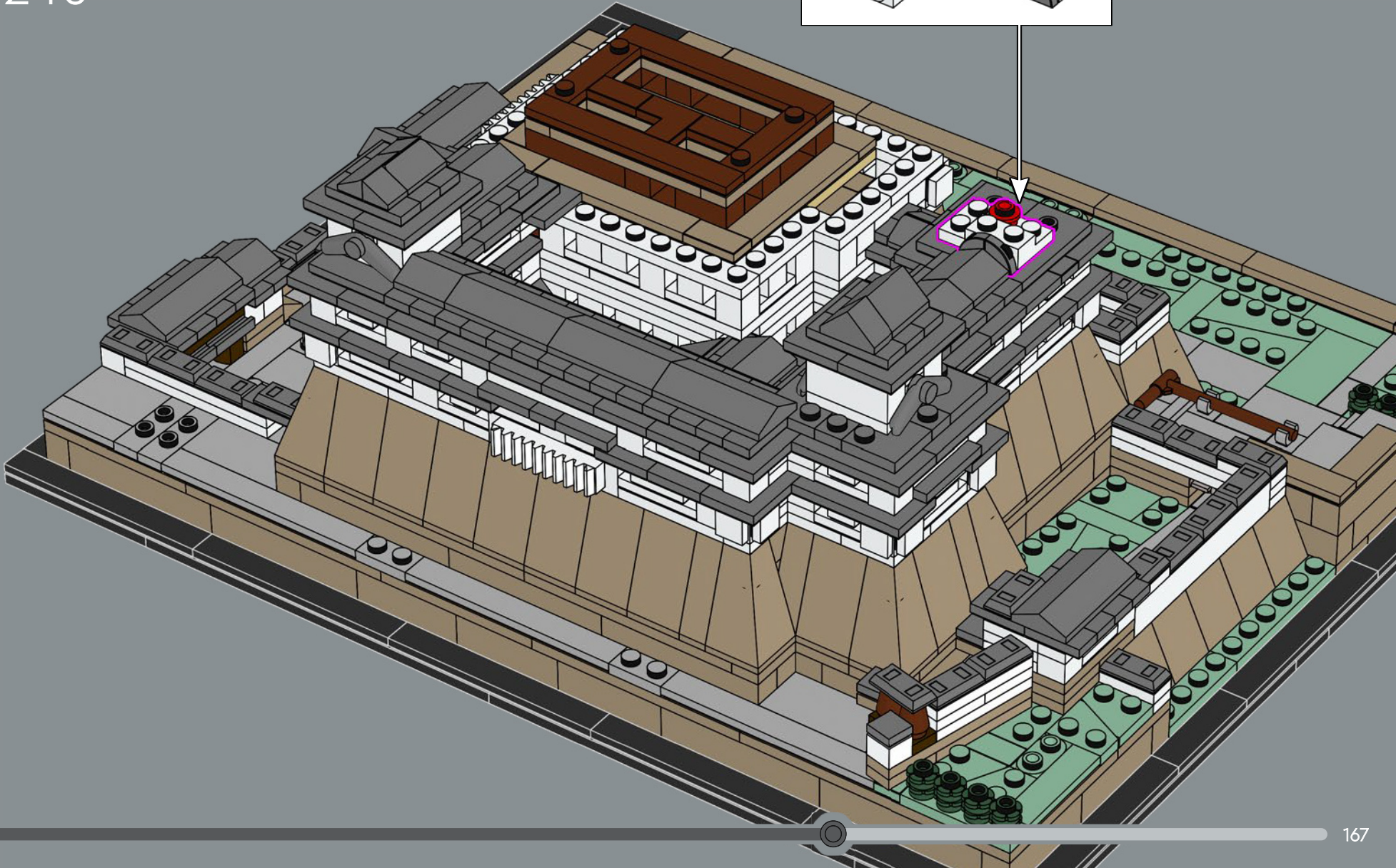
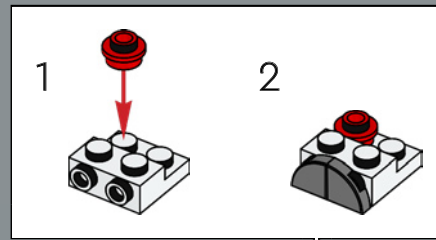

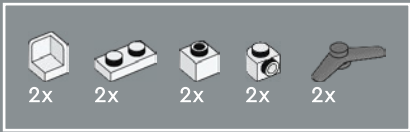

241

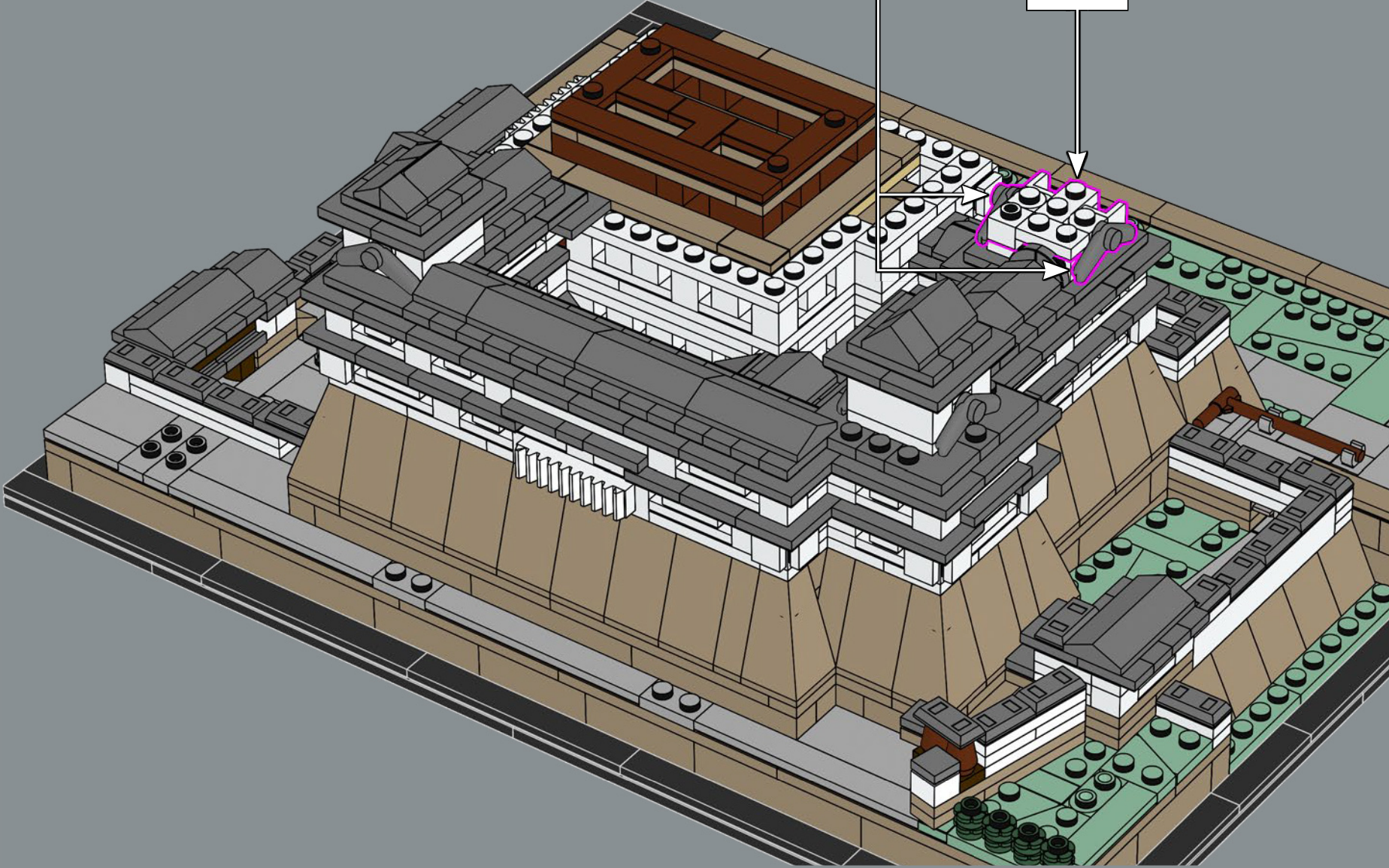
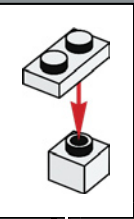
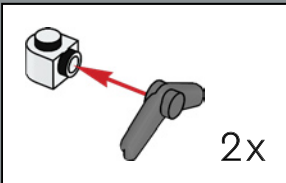

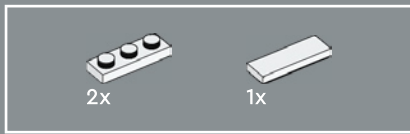

242

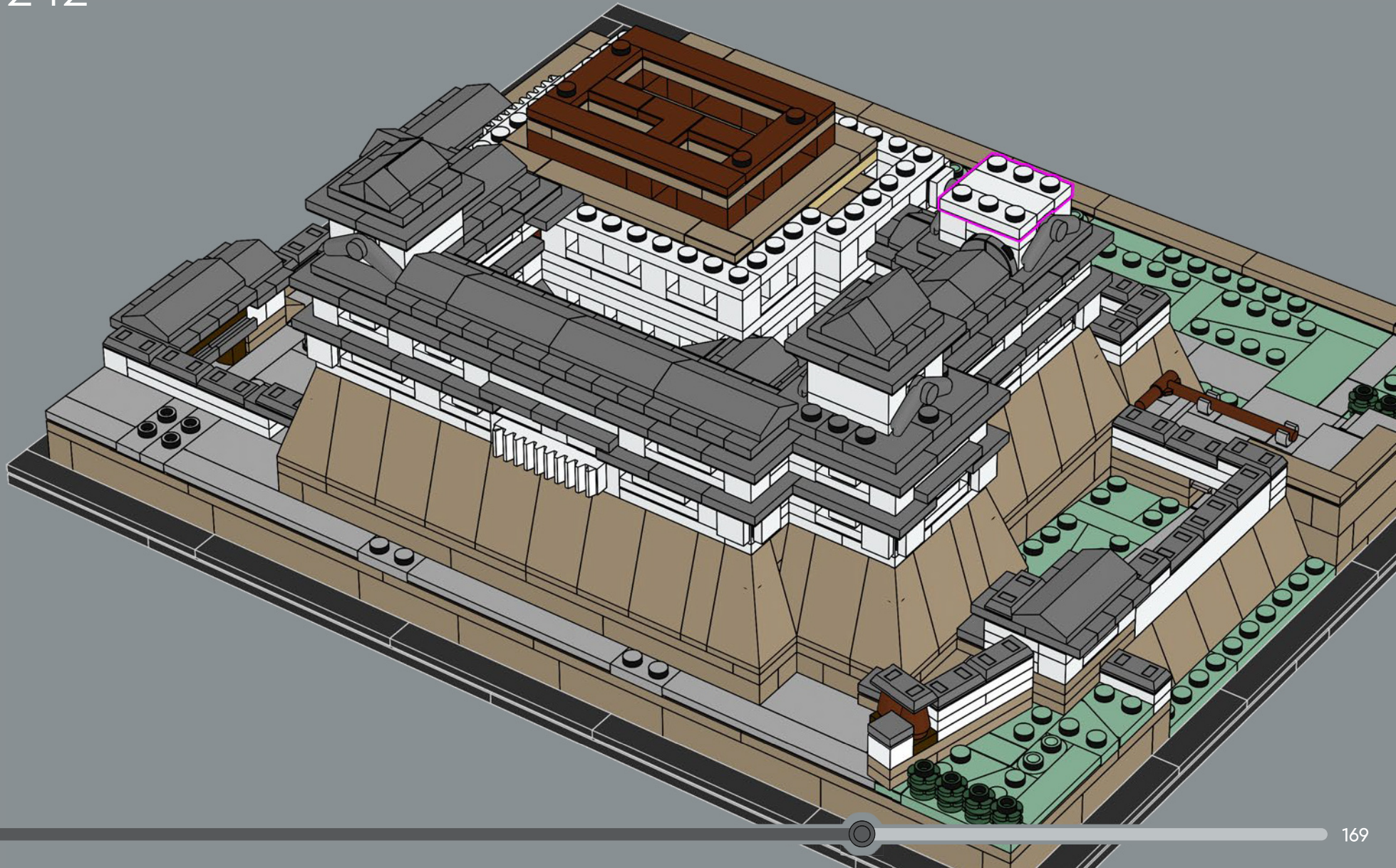

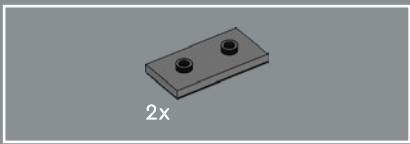

243

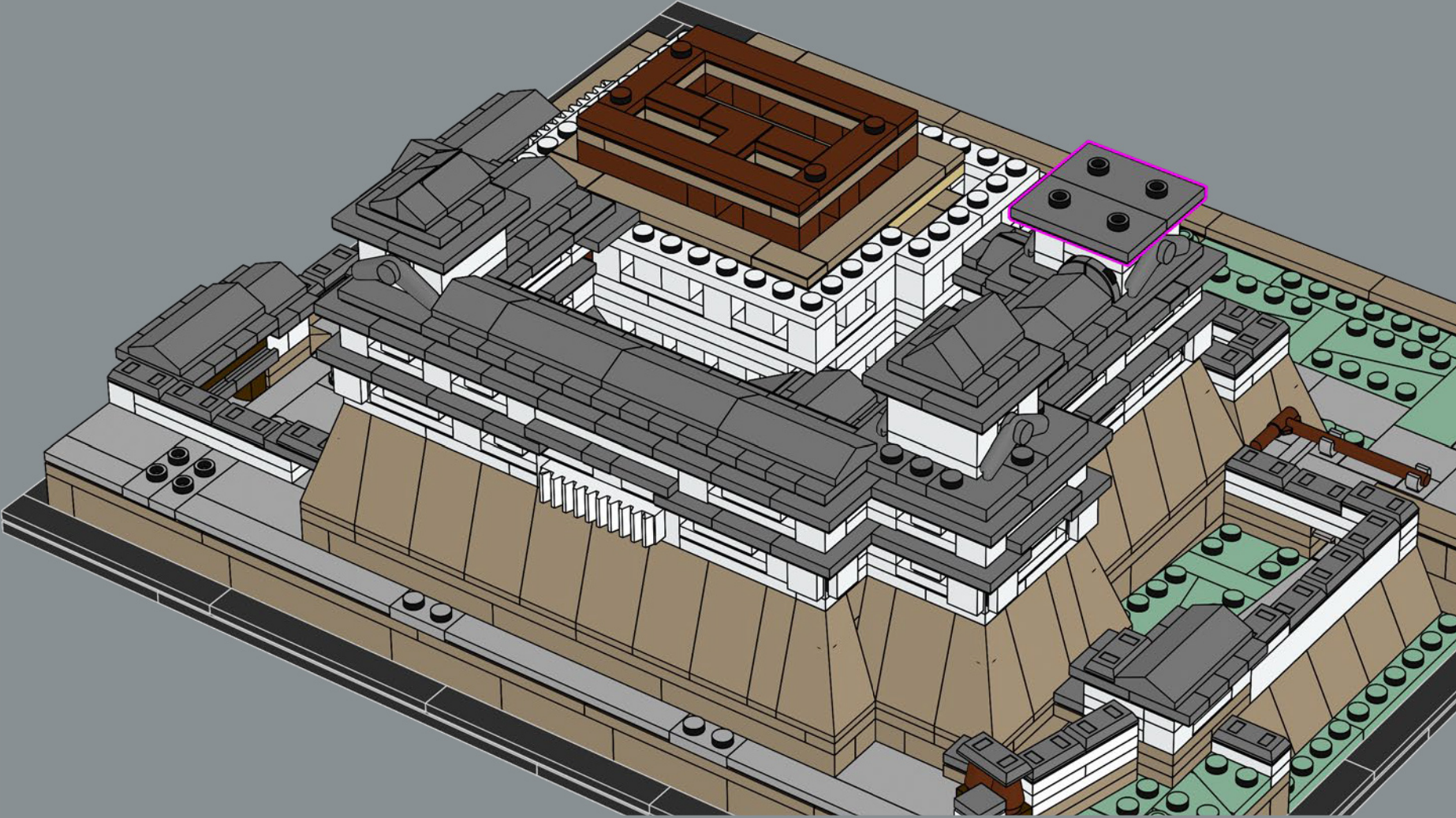

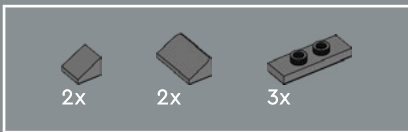

244

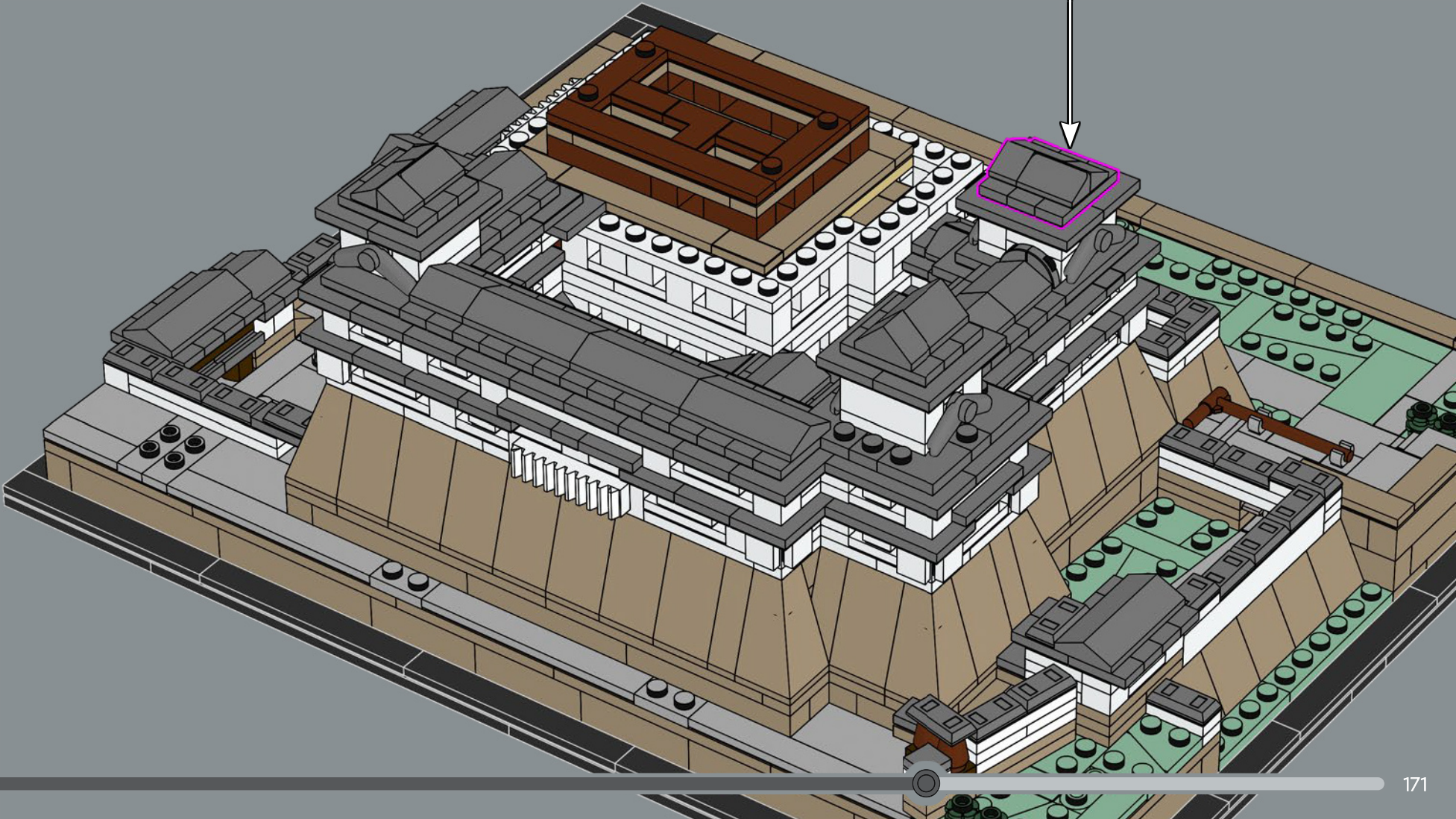
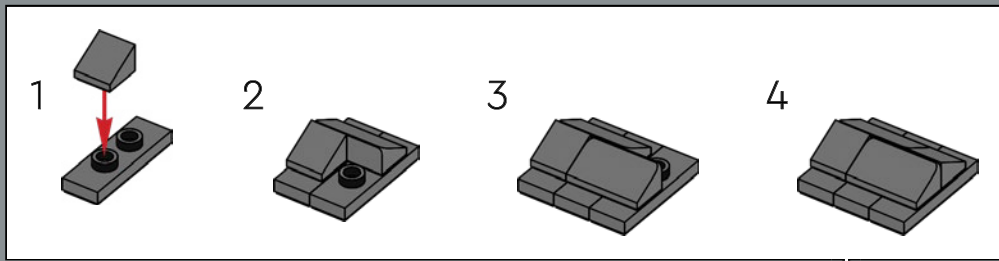

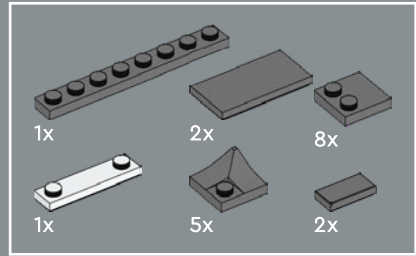

245

The new bowed 2x2 corner element is only the second NEW element to be approved for a LEGO® Architecture set. The first was a similar element in 3x3 size in Robie House 21010, (2011).

Le nouvel élément d'angle 2x2 arqué est seulement le deuxième NOUVEL élément à être approuvé pour un ensemble LEGO® Architecture. Le premier était un élément similaire en format 3x3 dans l'ensemble Robie House (21010), lancé en 2011.

El elemento 2x2 curvado de las esquinas es apenas el segundo elemento NUEVO en aprobarse para un set LEGO® Architecture. El primero fue uno parecido en formato 3x3 del set Casa Robie (21010) de 2011.

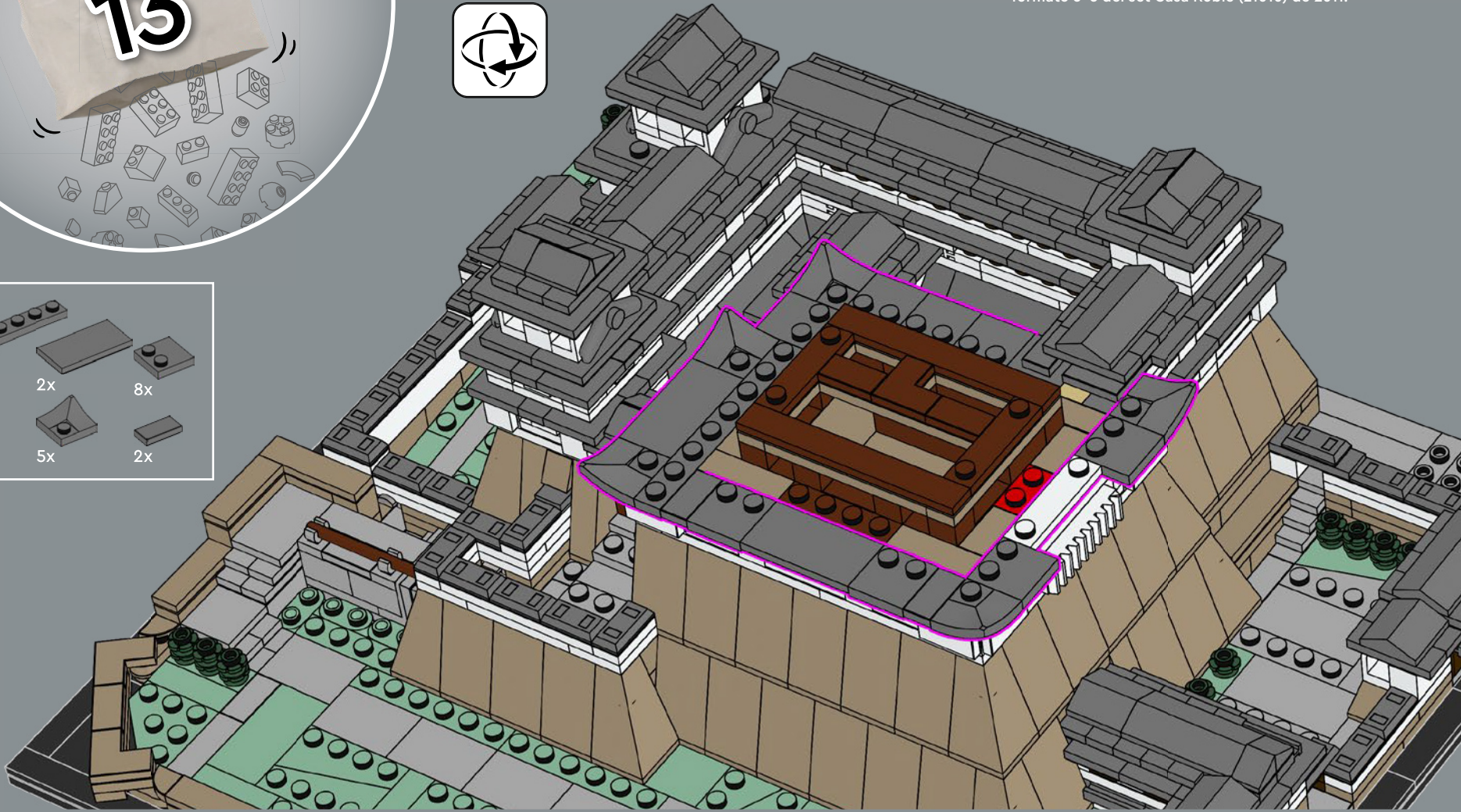

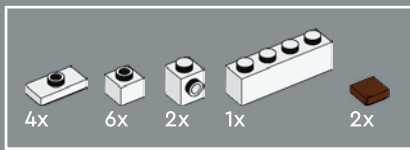

246

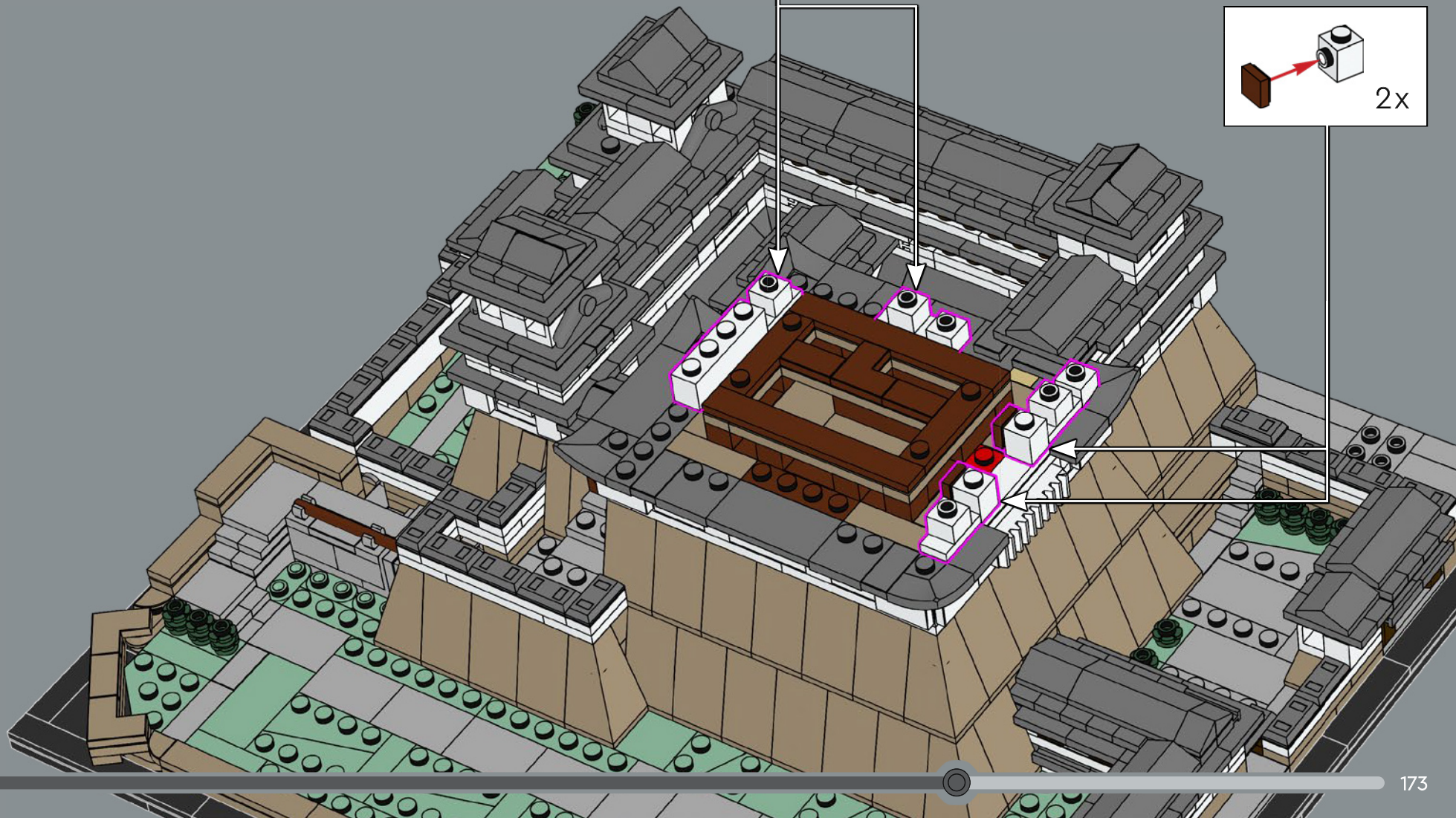
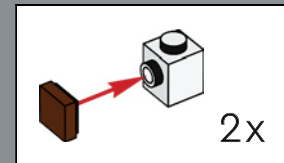
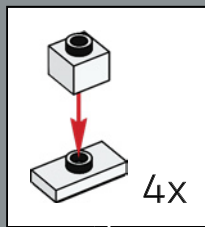

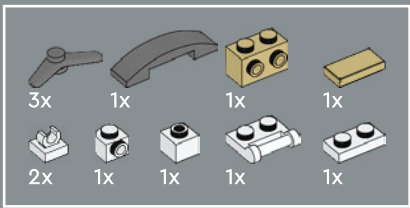

247

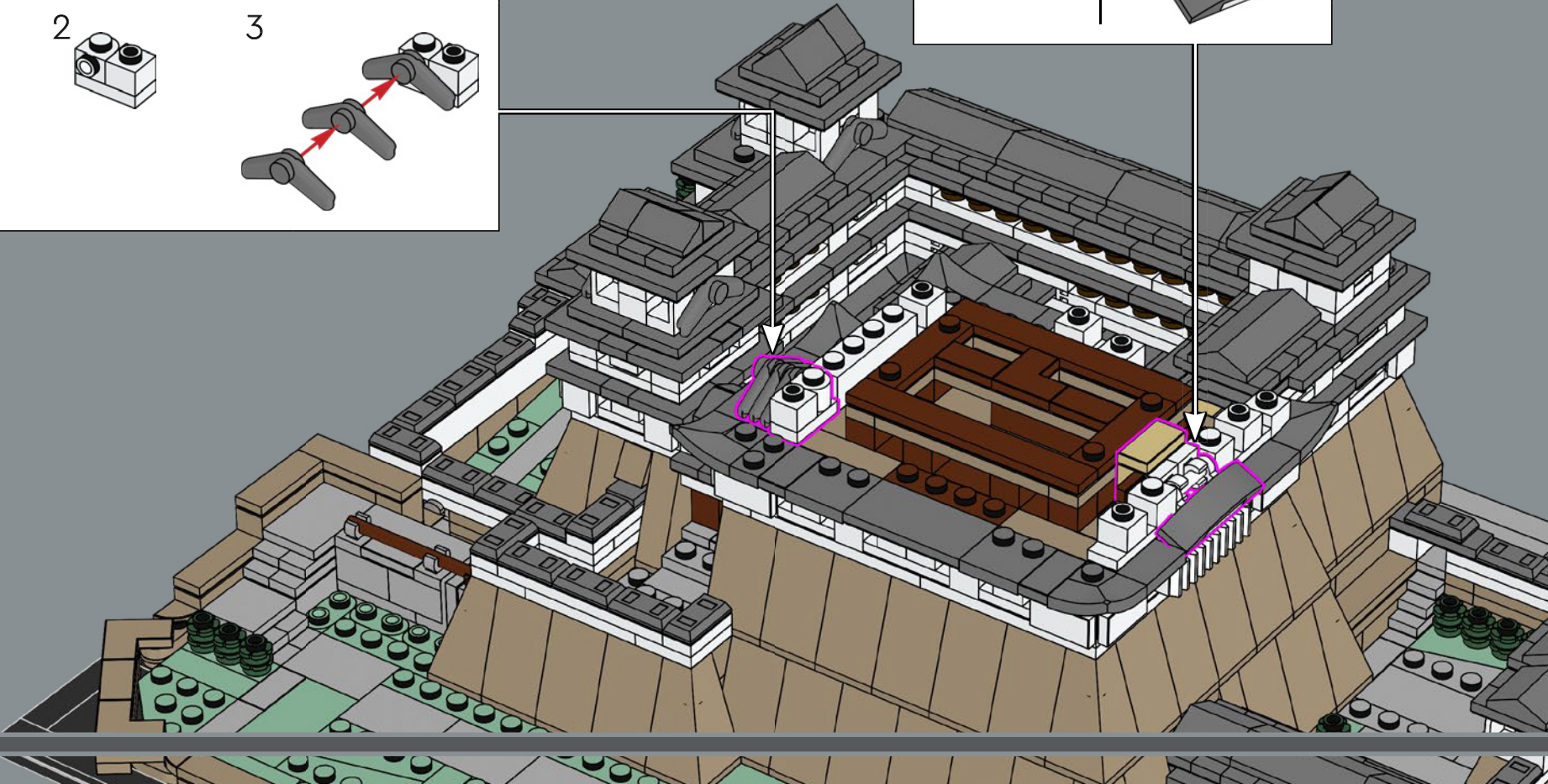
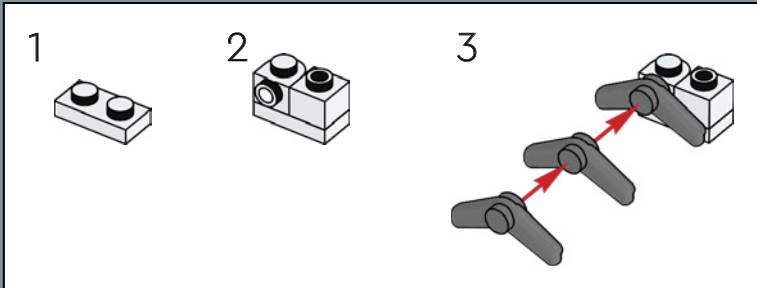
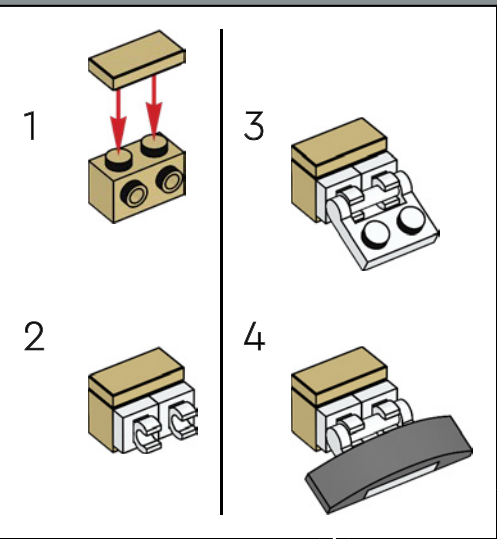

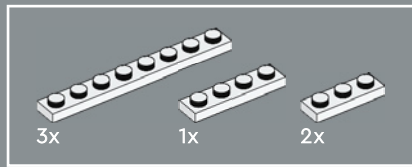

248

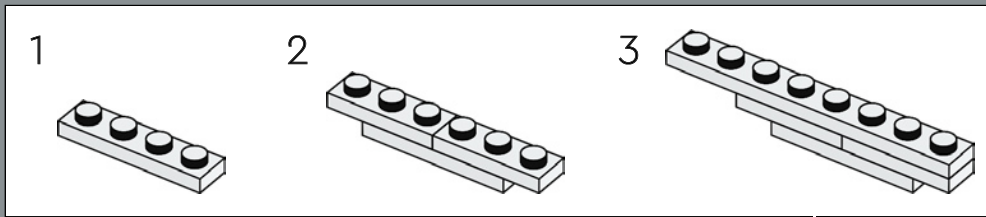

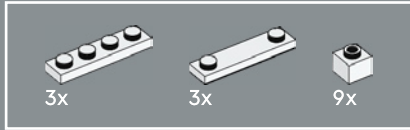
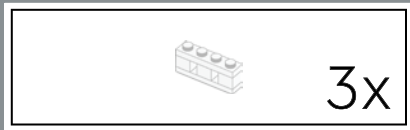

249

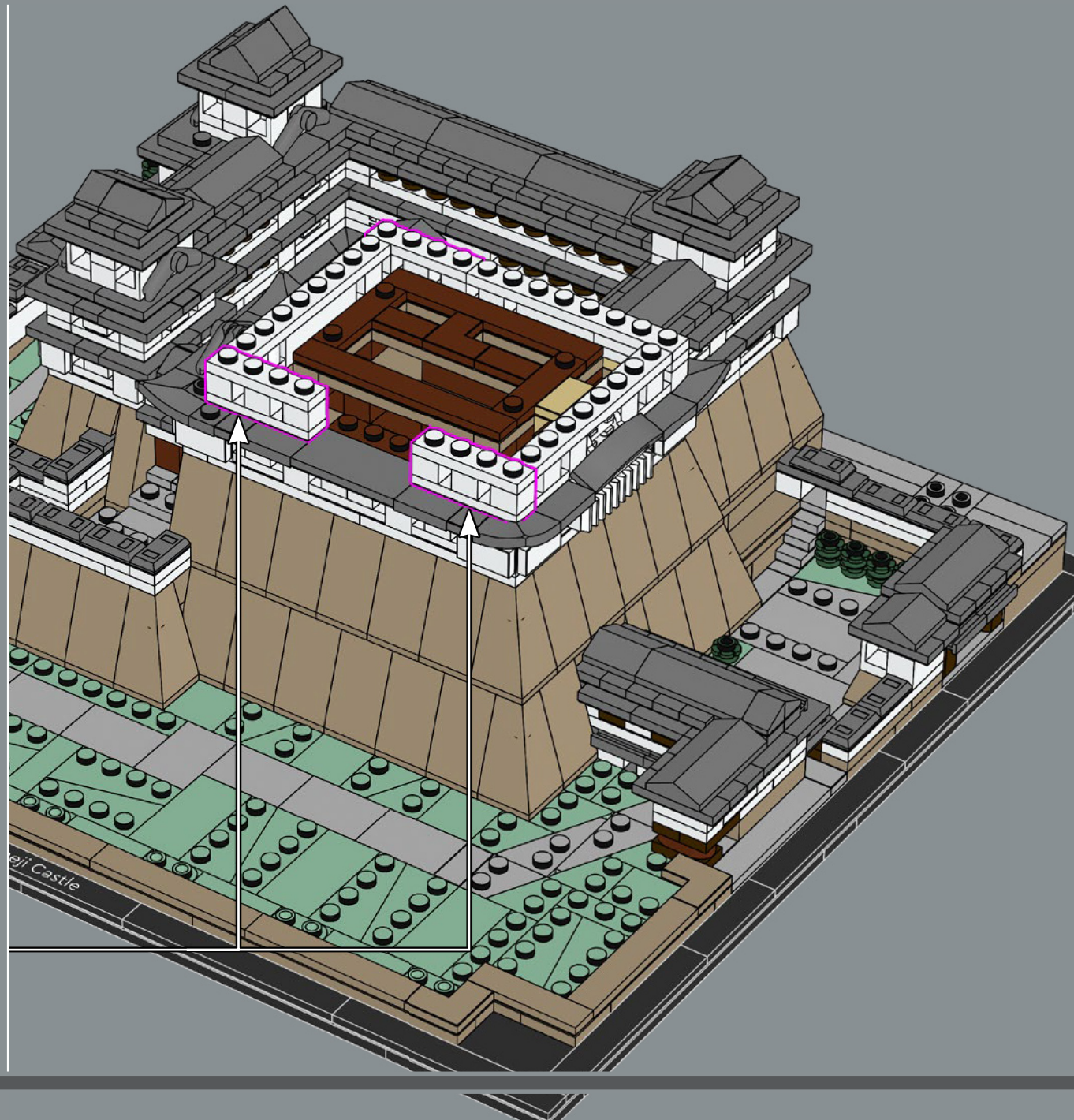
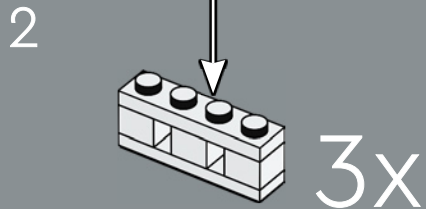
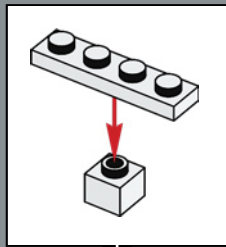
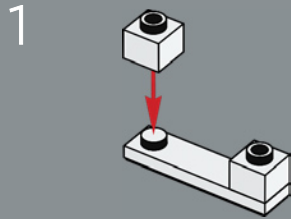

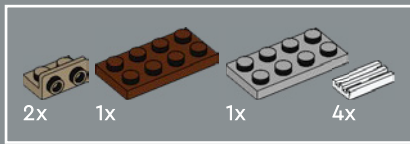

250

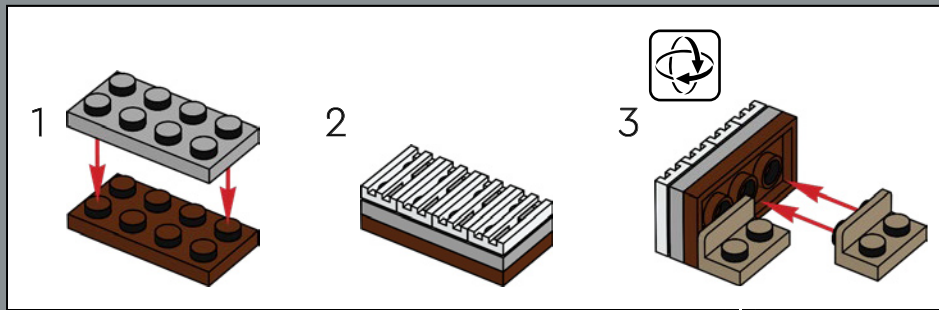

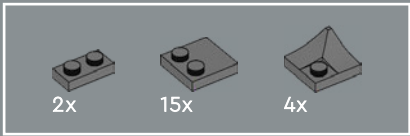

251



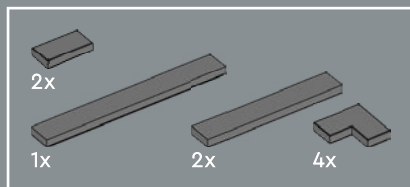

252

The top part of the structure can be removed to reveal some of the interiors, including the mostly empty council area to show what it looked like during the 2009–2015 renovation.

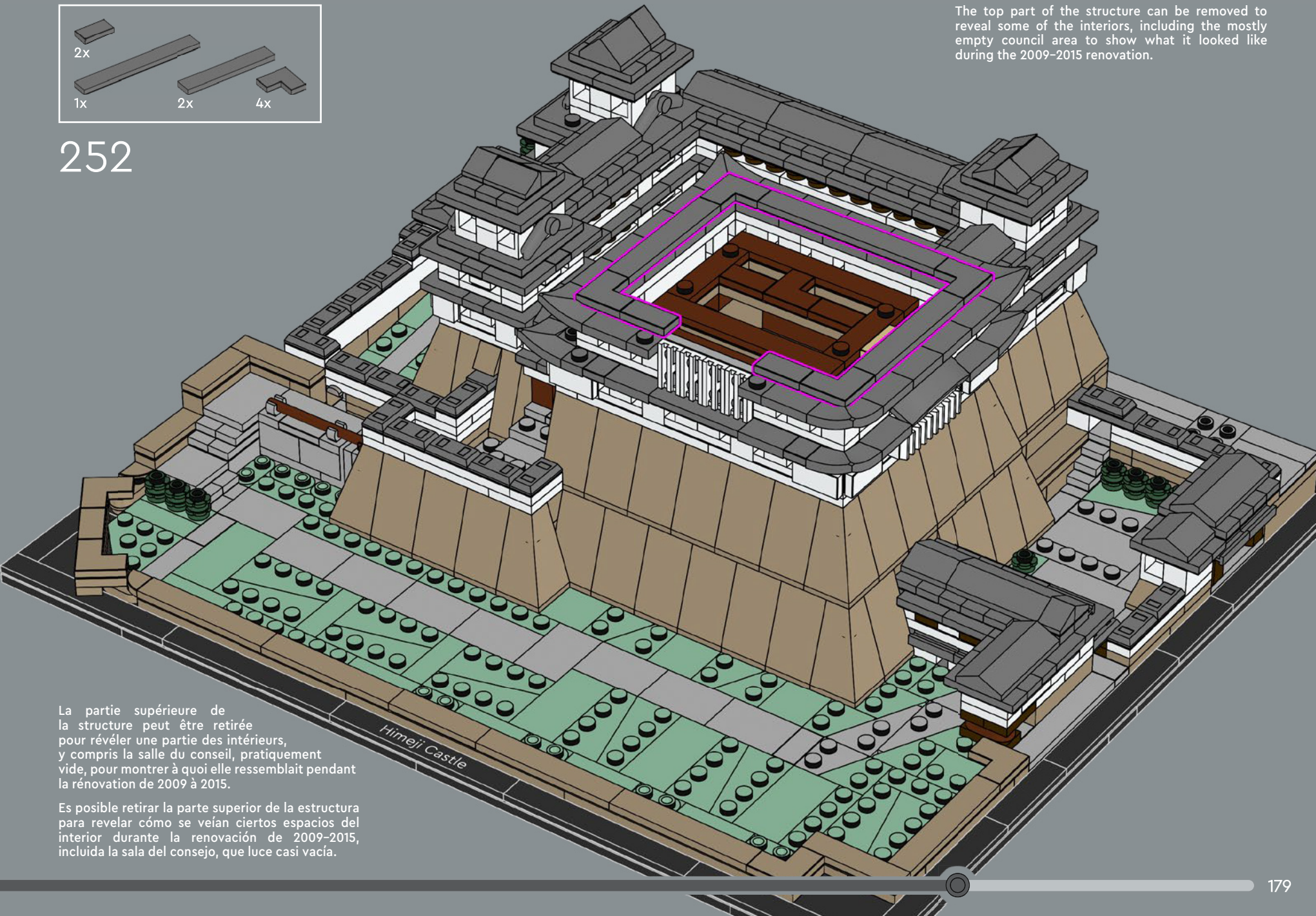

La partie supérieure de la structure peut être retirée pour révéler une partie des intérieurs, y compris la salle du conseil, pratiquement vide, pour montrer à quoi elle ressemblait pendant la rénovation de 2009 à 2015.

Es posible retirar la parte superior de la estructura para revelar cómo se veían ciertos espacios del interior durante la renovación de 2009–2015, incluida la sala del consejo, que luce casi vacía.

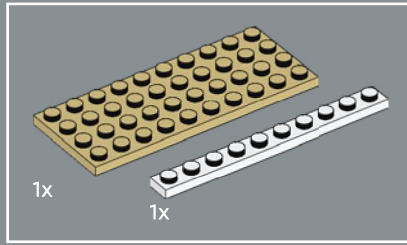
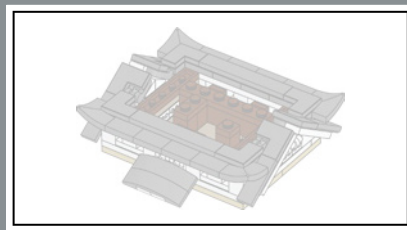

253

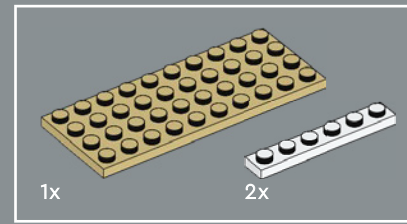
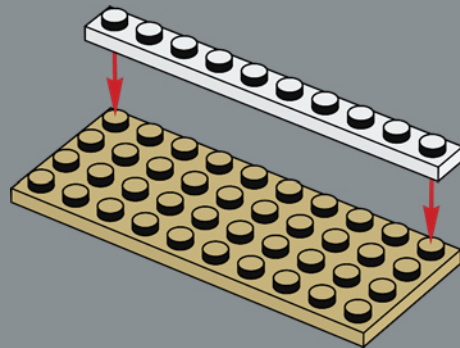

254

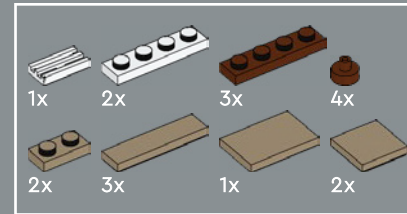
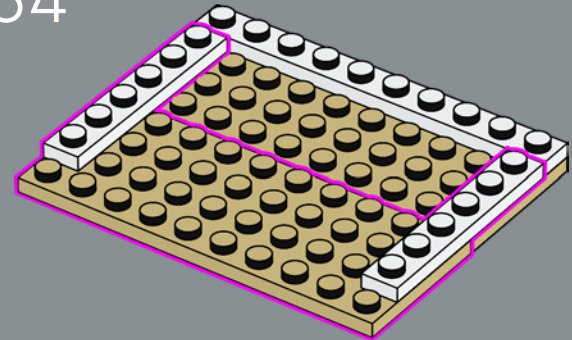

255

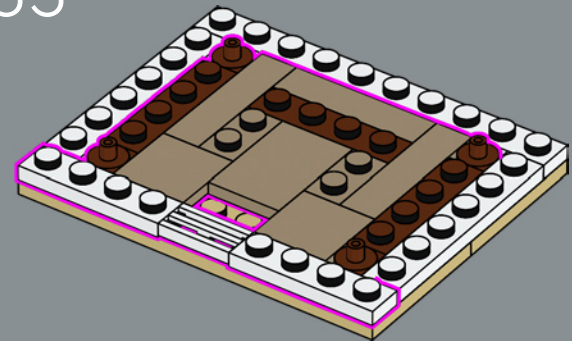

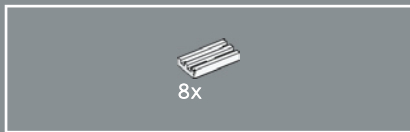

256

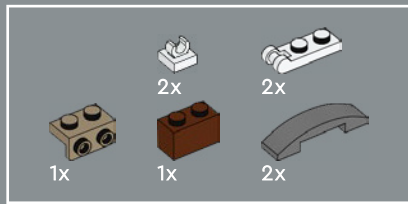
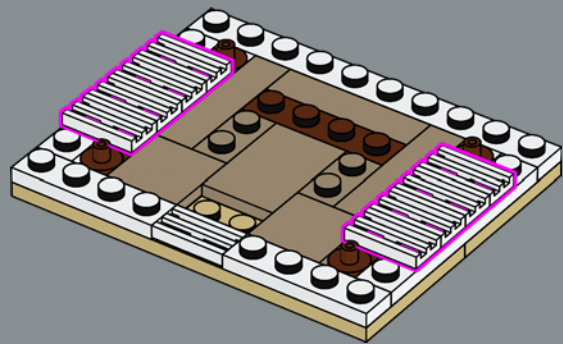

257

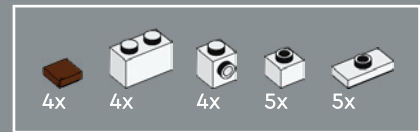
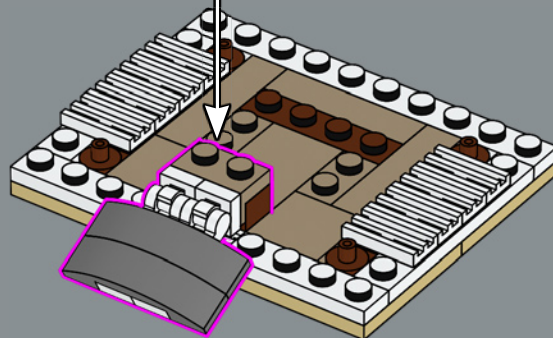
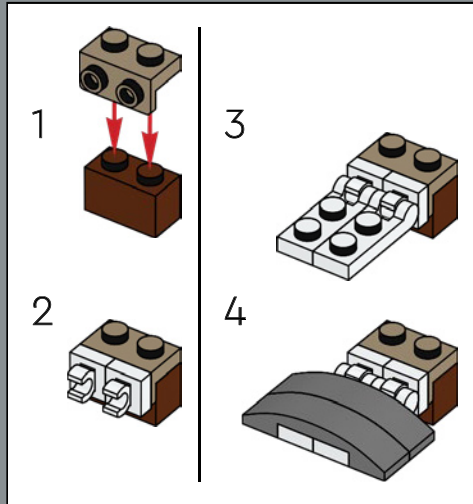

258

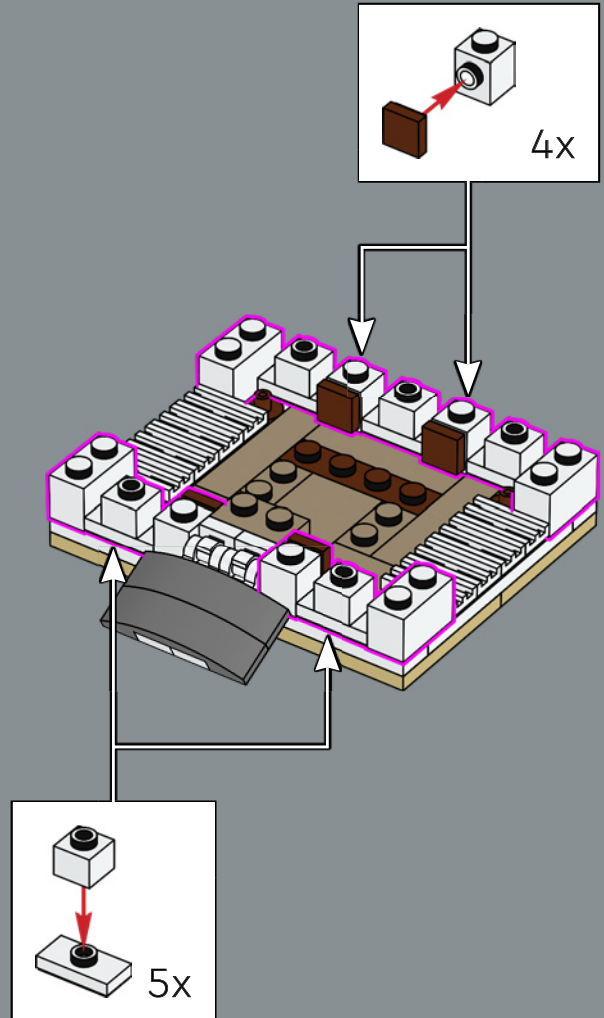

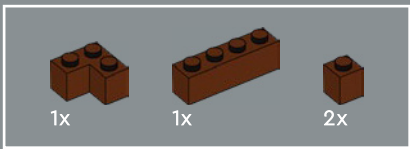

259

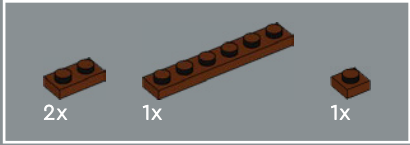
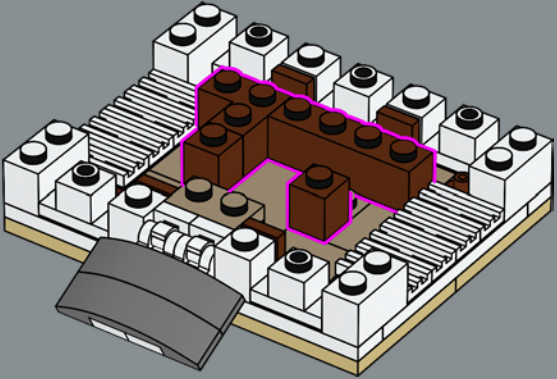

260

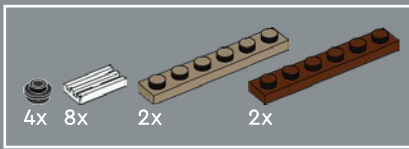
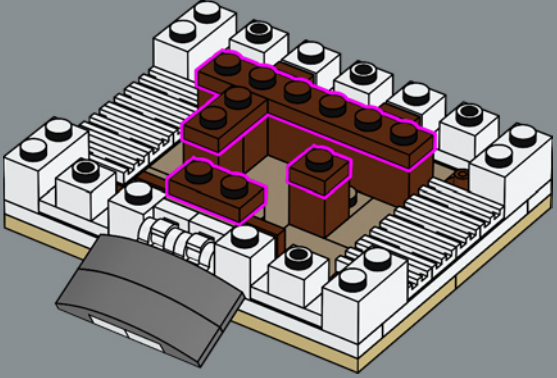

261

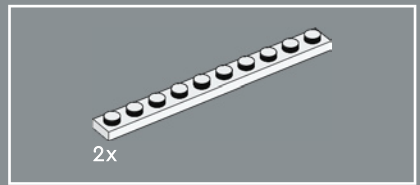
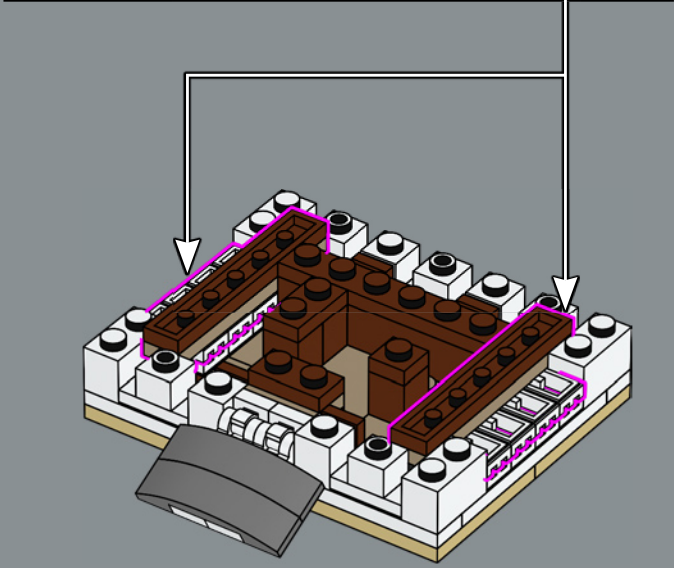
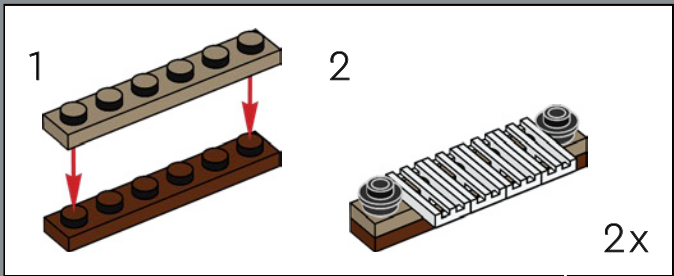

262

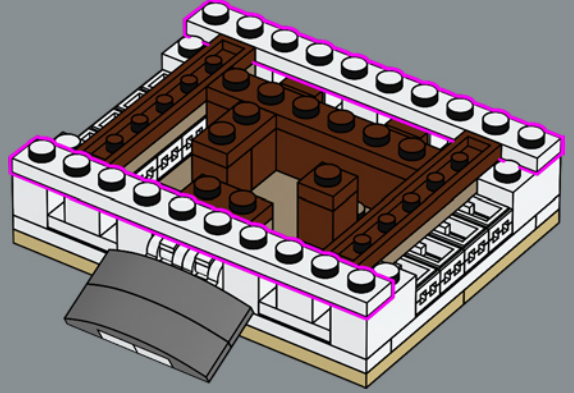

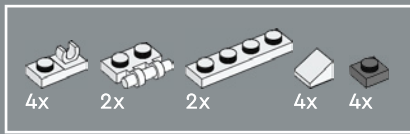

263

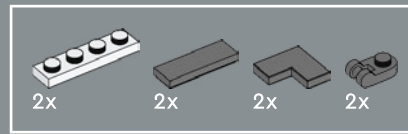
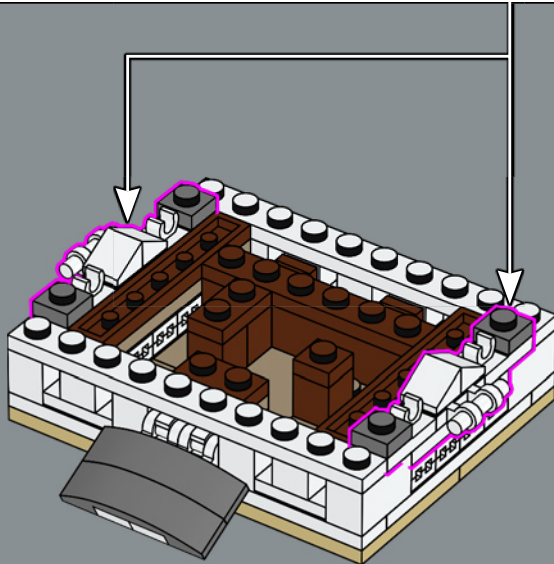
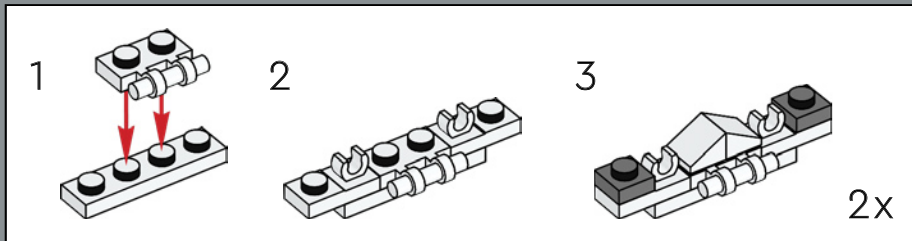

264

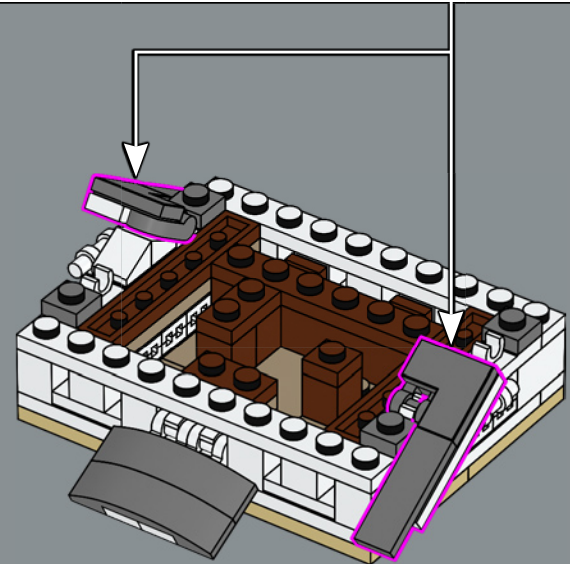
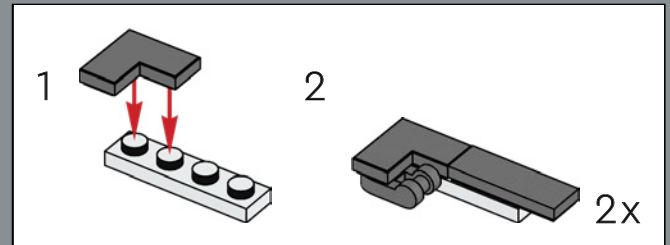

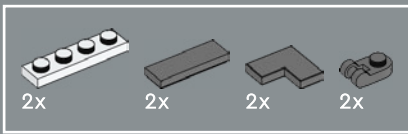

265

Each floor of the castle's Main Keep has a unique layout that draws from the floor plans of the original castle.

Chaque étage du donjon principal du château présente une disposition unique qui reflète les plans du château d'origine.

Cada piso de la torre mayor tiene una distribución particular que es distinta a la de todos los demás y se remonta al diseño del castillo original.

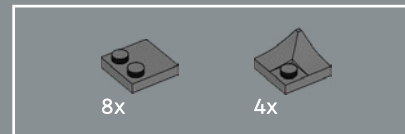
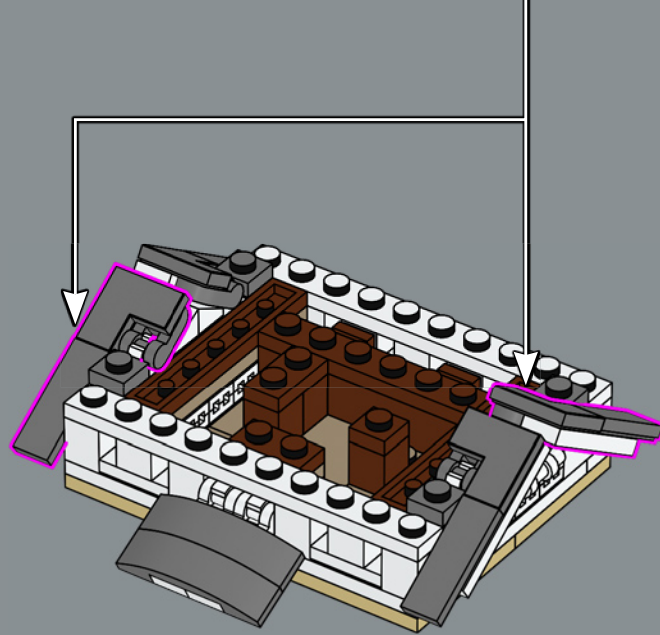
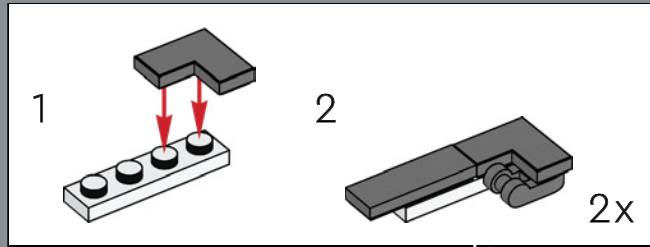

266

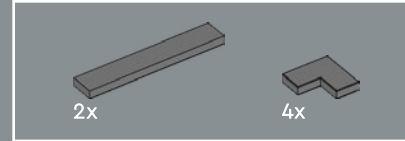
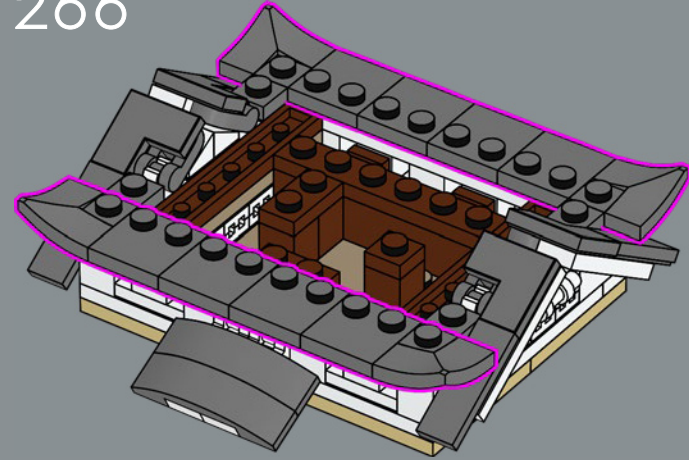

267

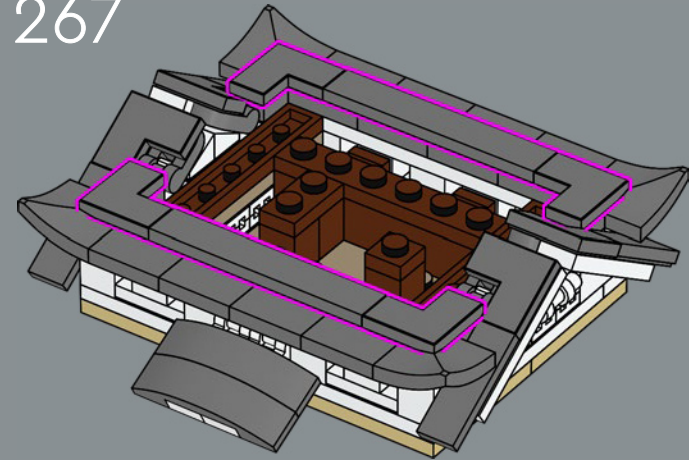

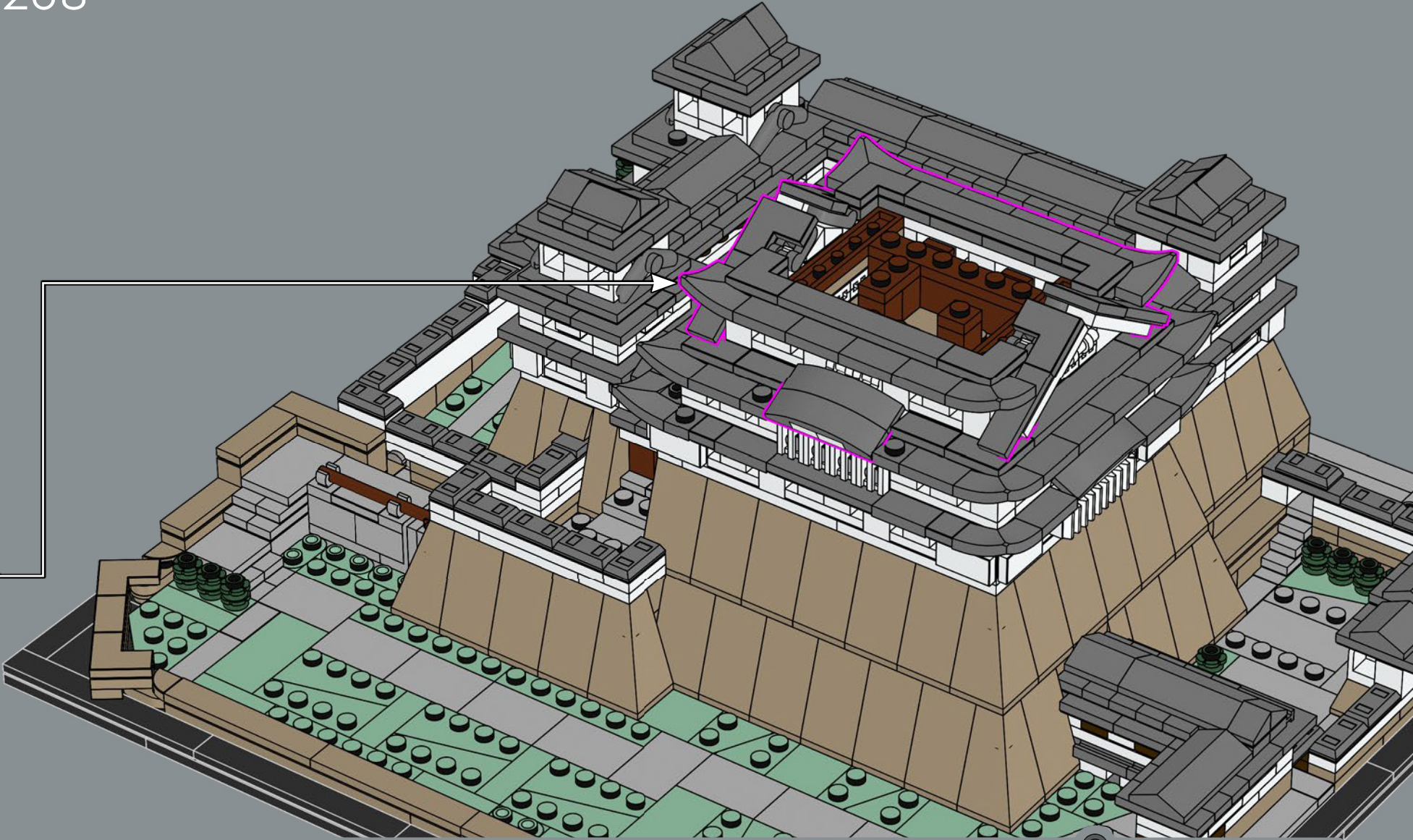

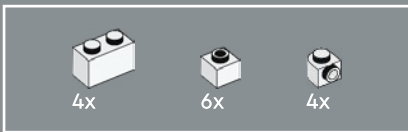

272

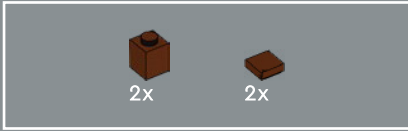
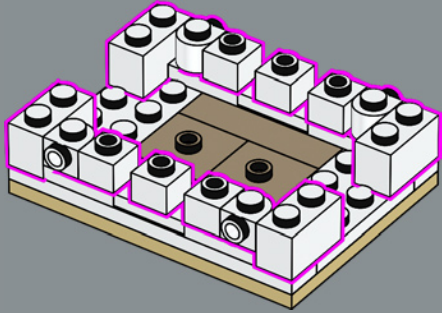

273

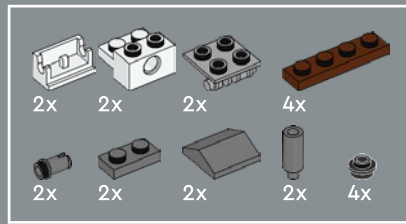
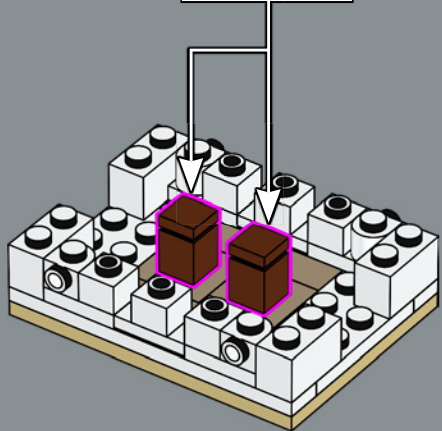
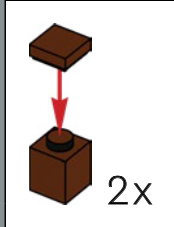

274

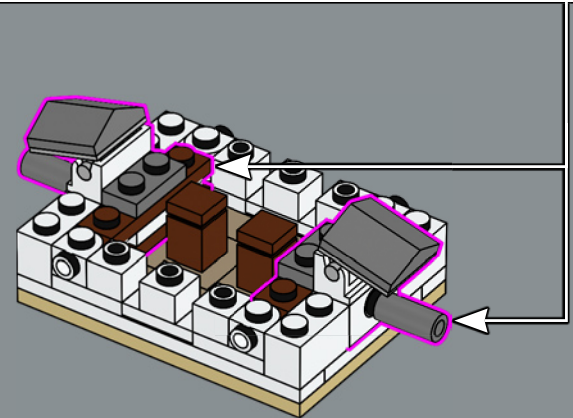
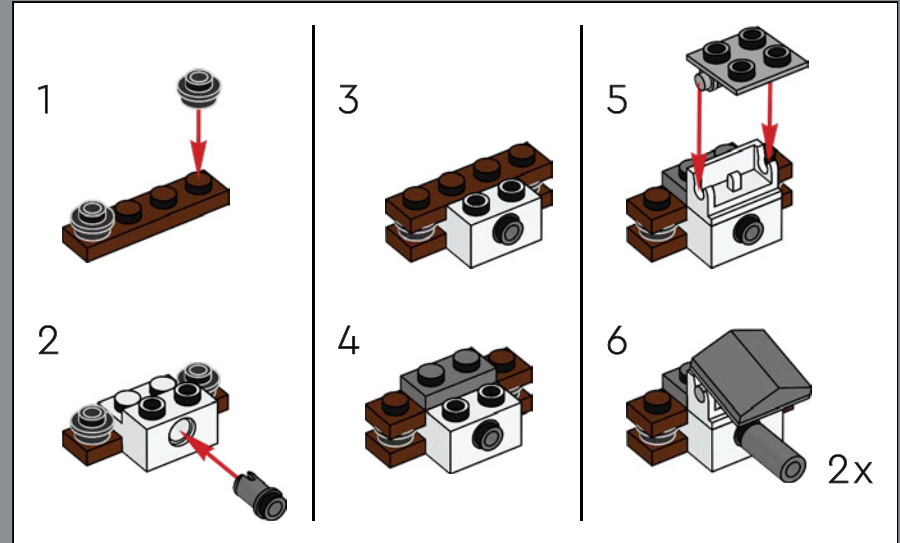

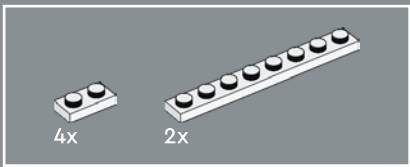

275

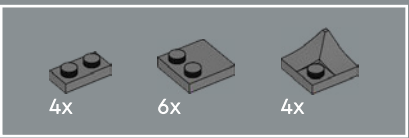
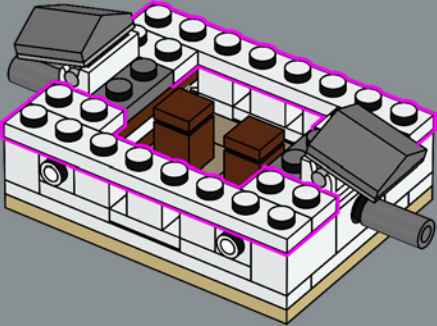

277

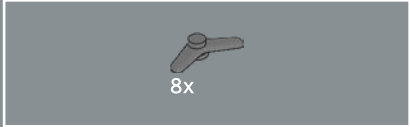
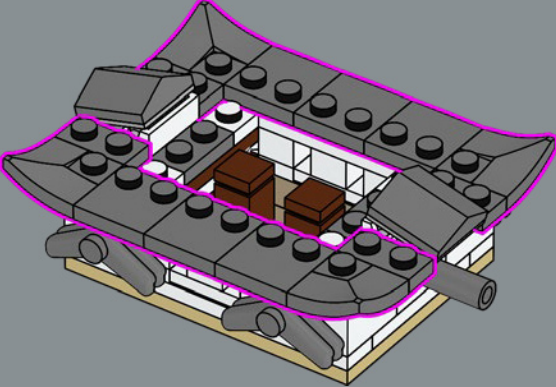

276

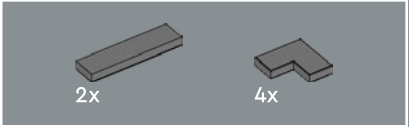
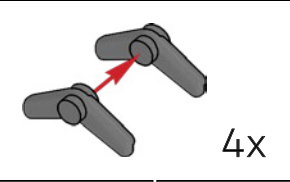
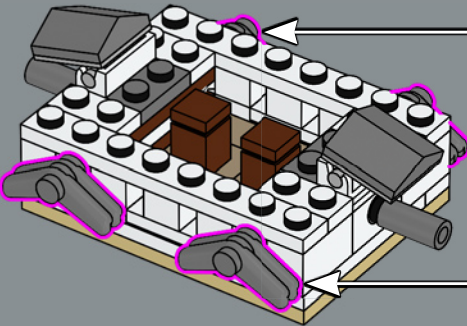

278

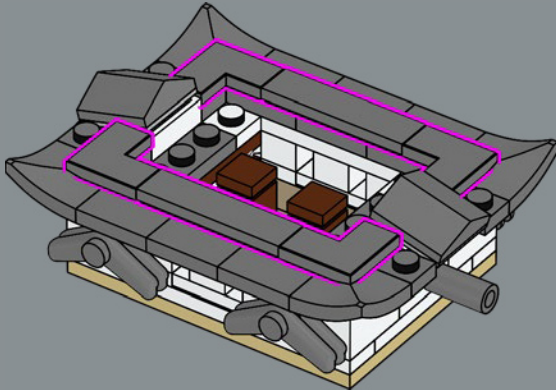

LEGO® boomerang elements are used for the small awnings above the window structures.

Les éléments de boomerang LEGO® sont utilisés pour les petits auvents au-dessus des structures des fenêtres.

Se usaron bumeranes LEGO® para dar forma a las marquesinas que coronan las estructuras de las ventanas.

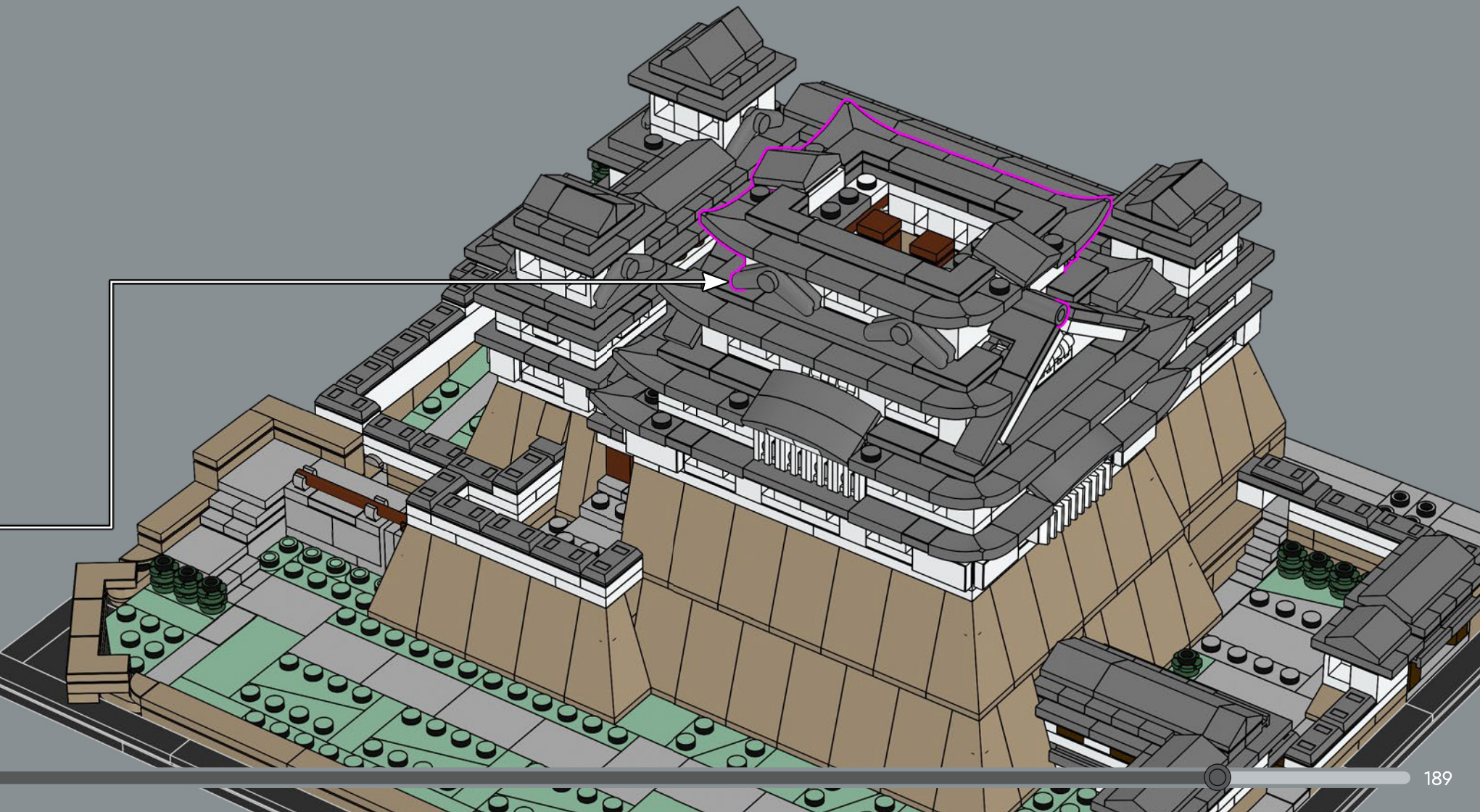

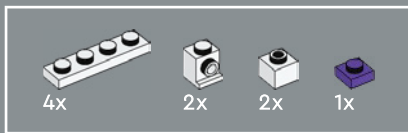

284

The purple 1×1 tile in the top floor chamber of the Main Keep is a nod to the small sacred wooden shrine covered in a purple drape inside this castle chamber.

La tuile violette 1×1 dans la chambre de l'étage supérieur du donjon principal fait référence au petit autel sacré en bois recouvert d'une draperie violette à l'intérieur de cette chambre du château.

La cubierta 1×1 en morado de la cámara superior de la torre mayor hace referencia al pequeño santuario de madera cubierto por una cortina del mismo color que hay en el castillo real.

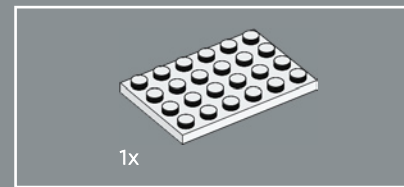
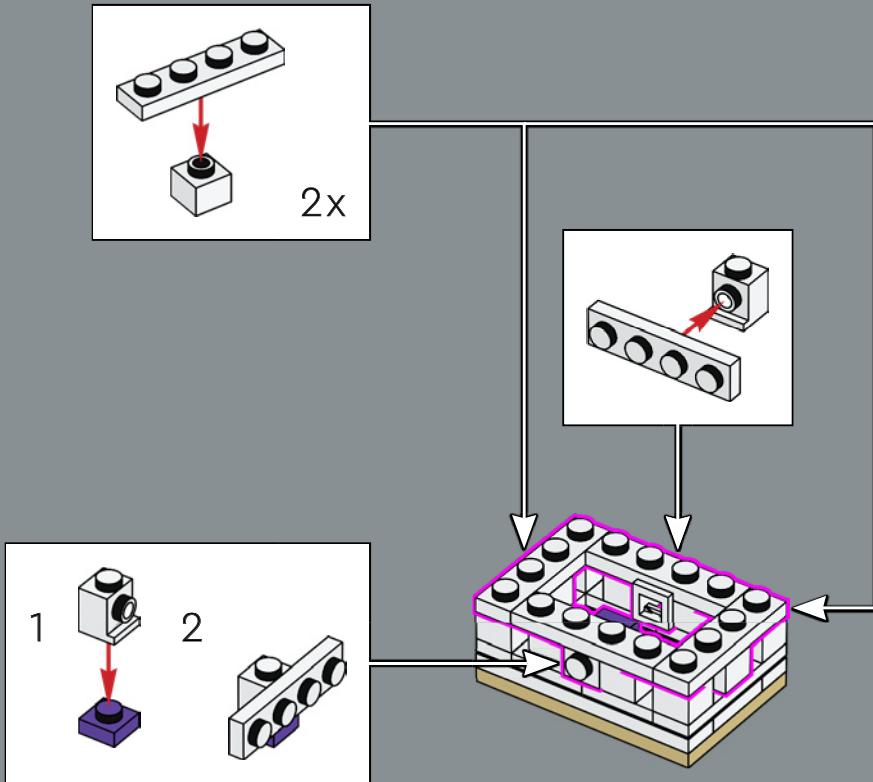

285

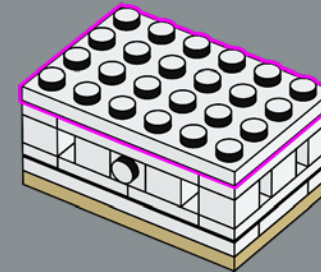

286

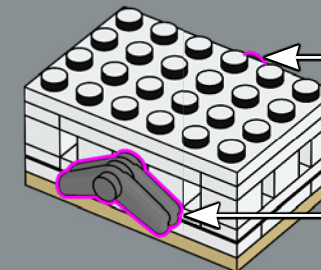
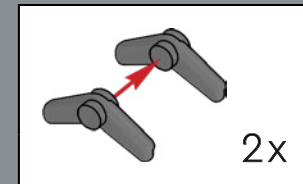

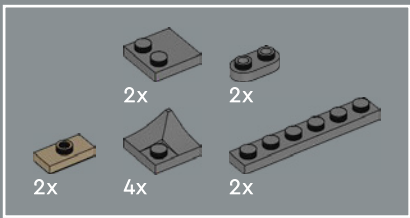

287

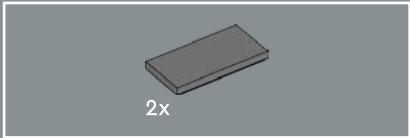
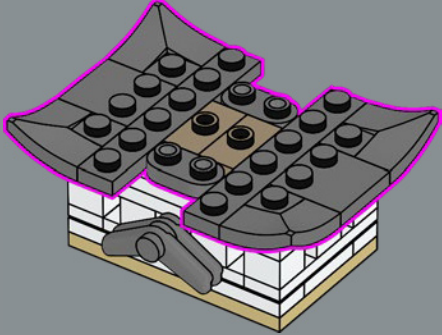

288

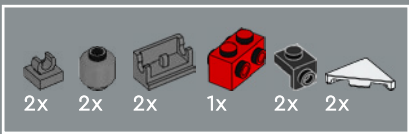
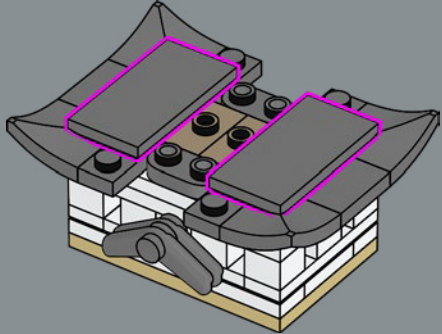

289

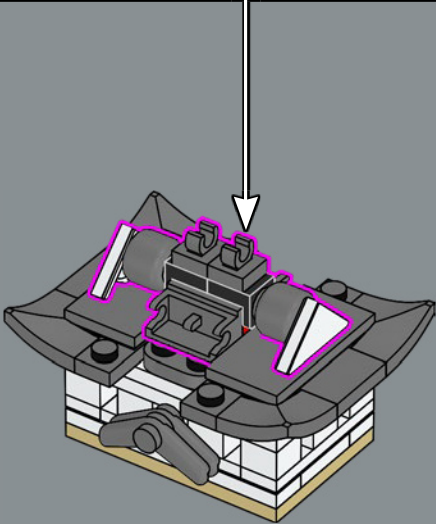
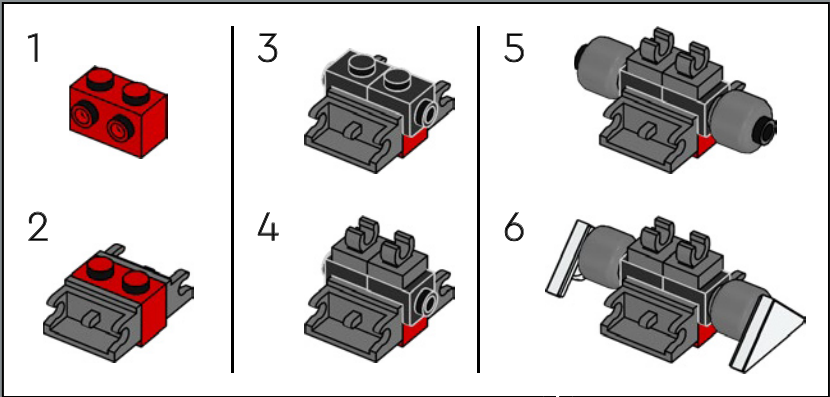

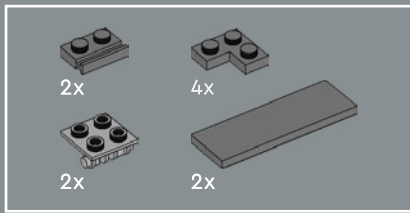

290

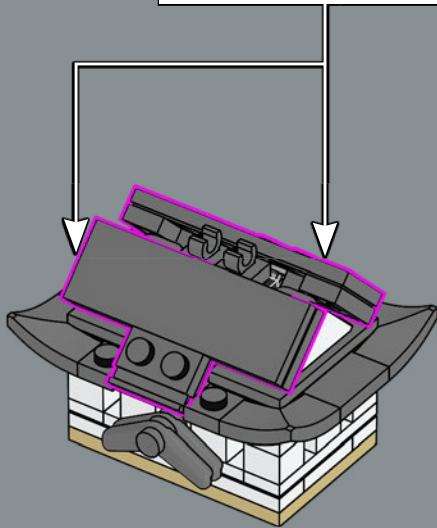
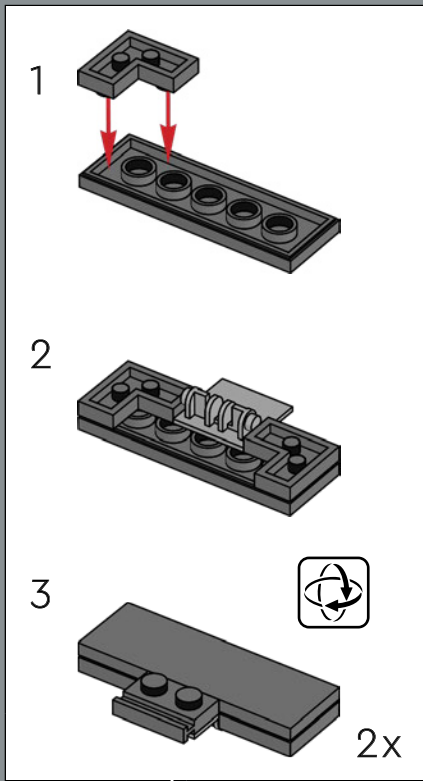

291

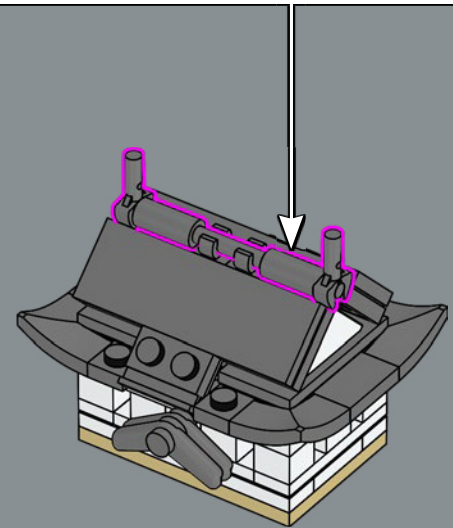
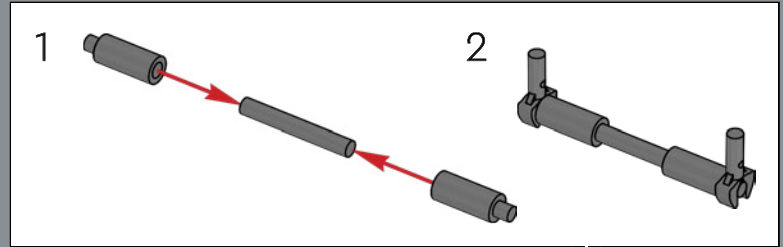

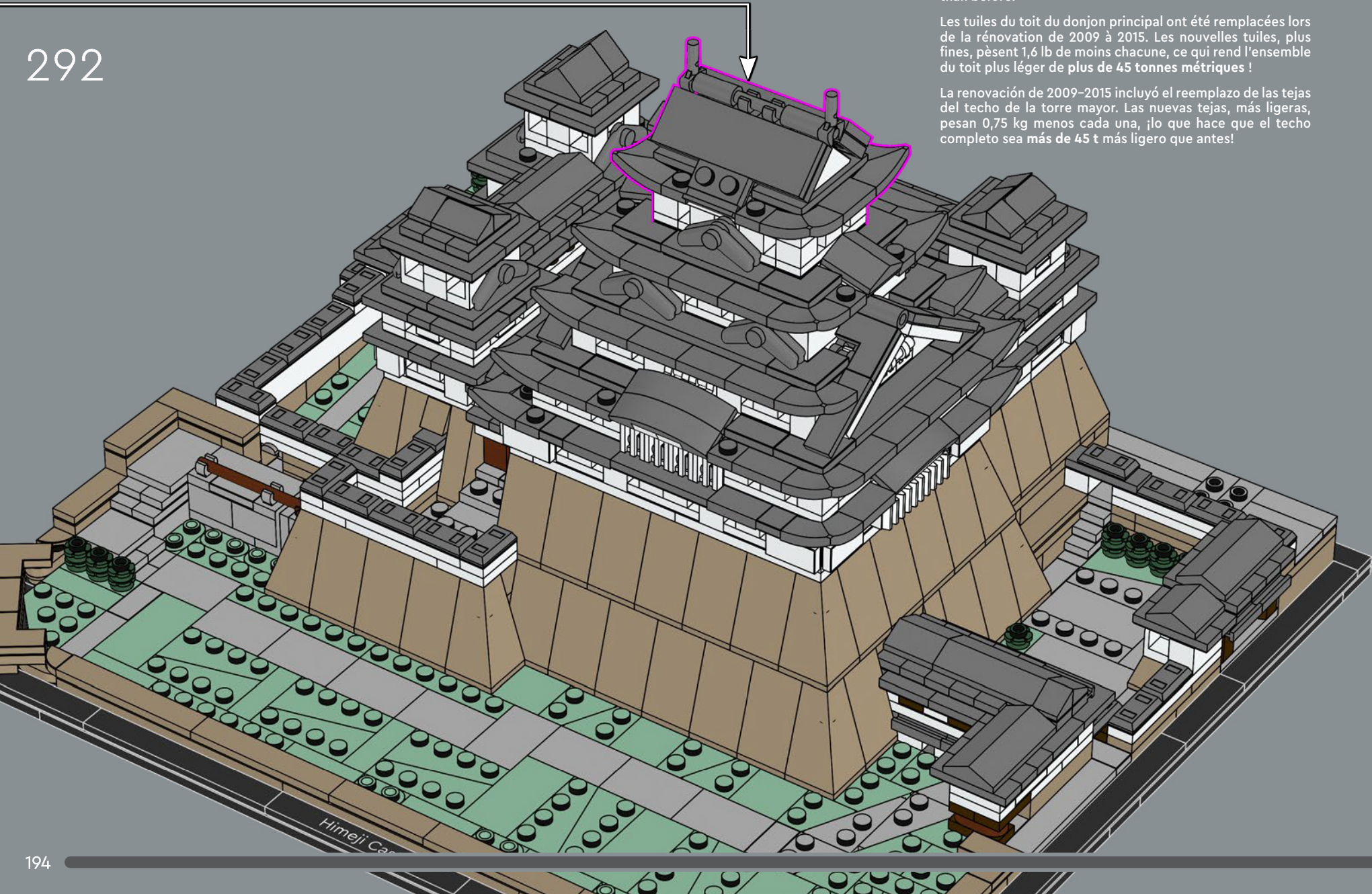

The Main Keep roof tiles were replaced during the 2009–2015 renovation. The new, thinner tiles weigh 1.6 lbs. (0.75 kg) less per tile, making the entire roof 50+ tons (45+ tonnes) lighter than before!

Les tuiles du toit du donjon principal ont été remplacées lors de la rénovation de 2009 à 2015. Les nouvelles tuiles, plus fines, pèsent 1,6 lb de moins chacune, ce qui rend l'ensemble du toit plus léger de plus de 45 tonnes métriques !

La renovación de 2009–2015 incluyó el reemplazo de las tejas del techo de la torre mayor. Las nuevas tejas, más ligeras, pesan 0,75 kg menos cada una, ¡lo que hace que el techo completo sea más de 45 t más ligero que antes!



3x



3x

293

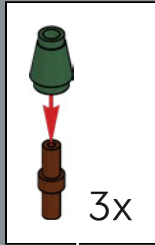

3x

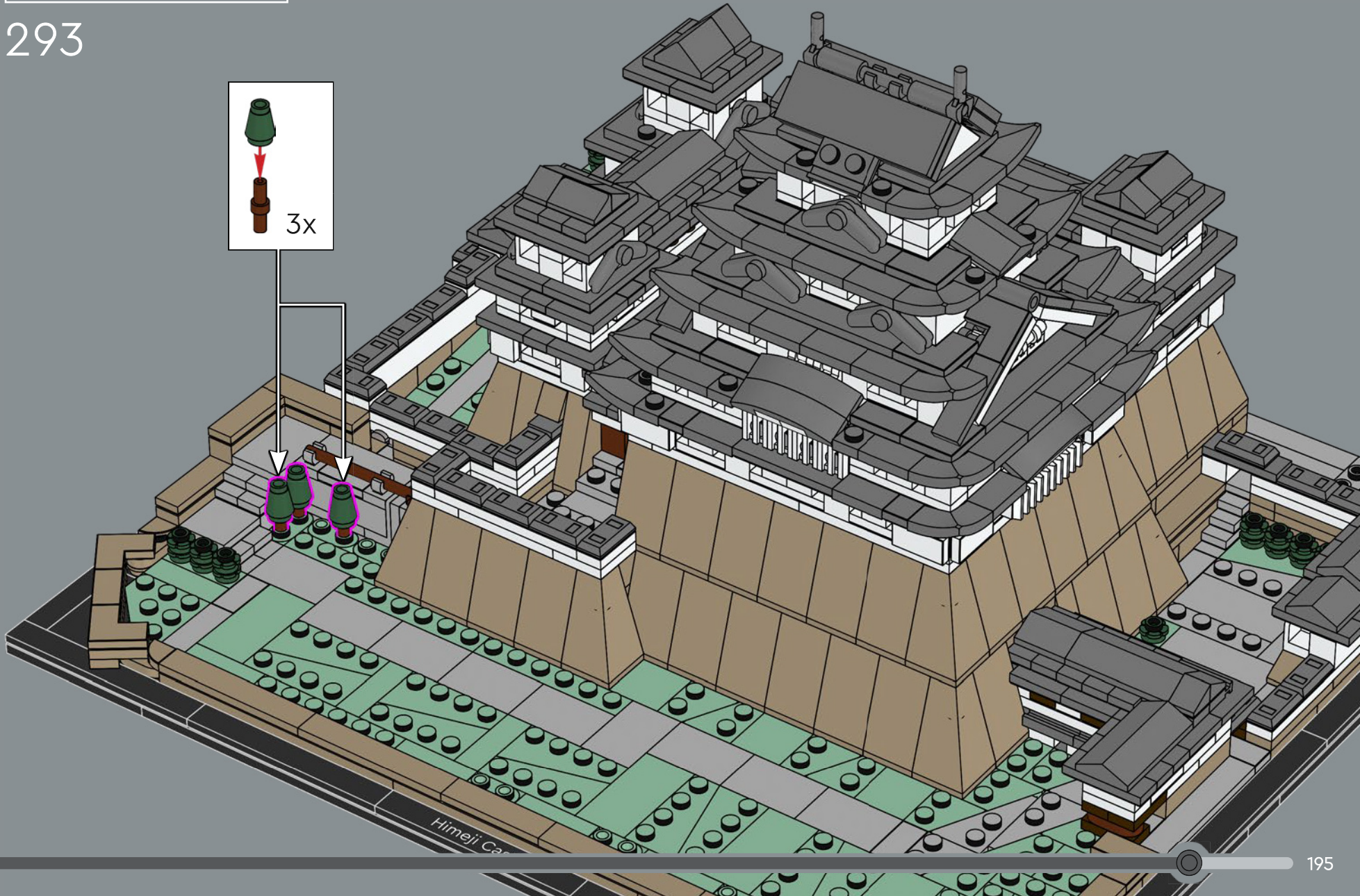



294

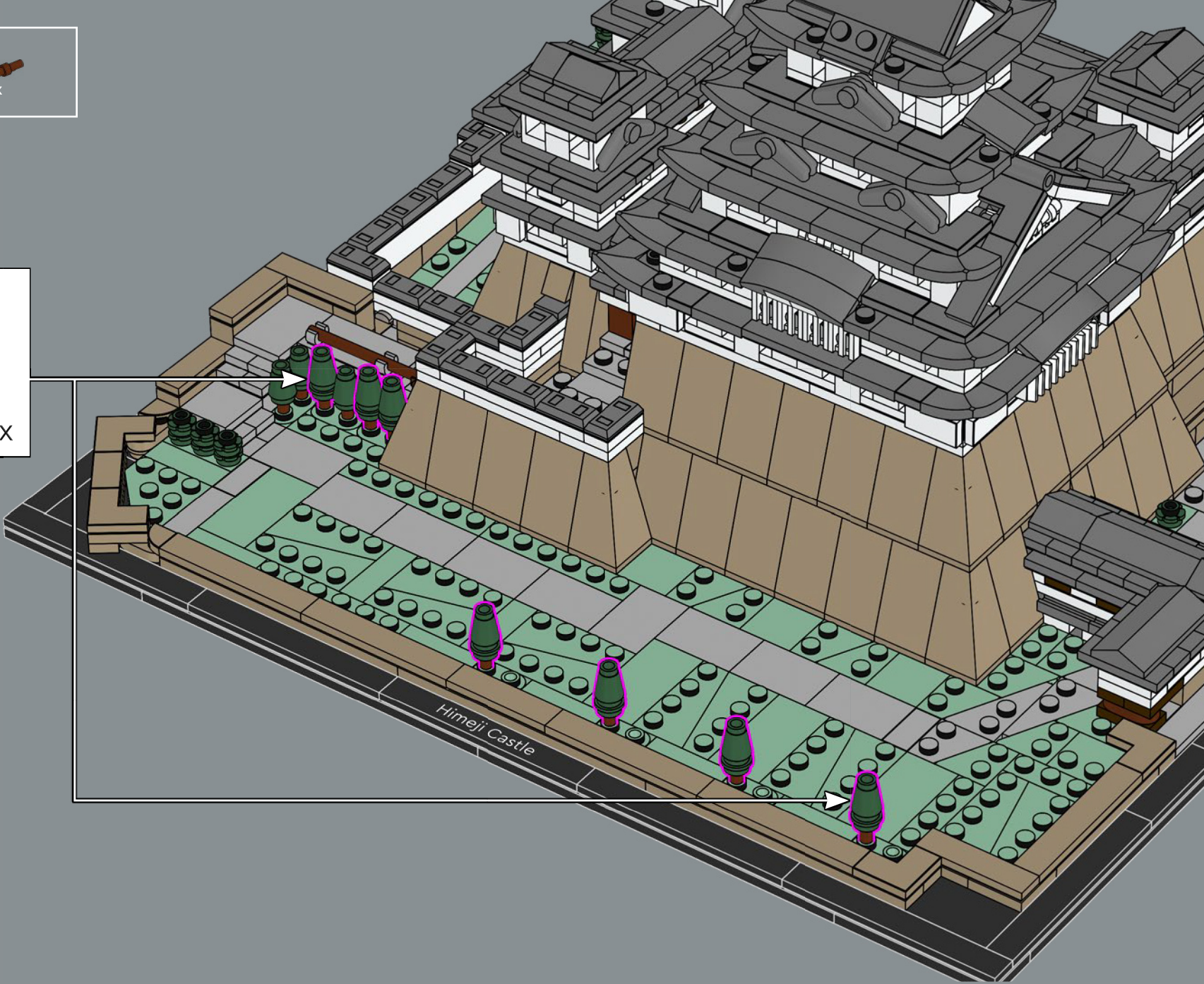
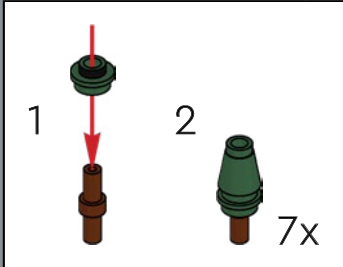

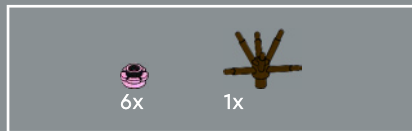

295

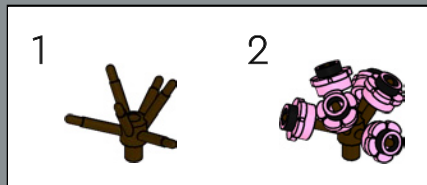

3x

296

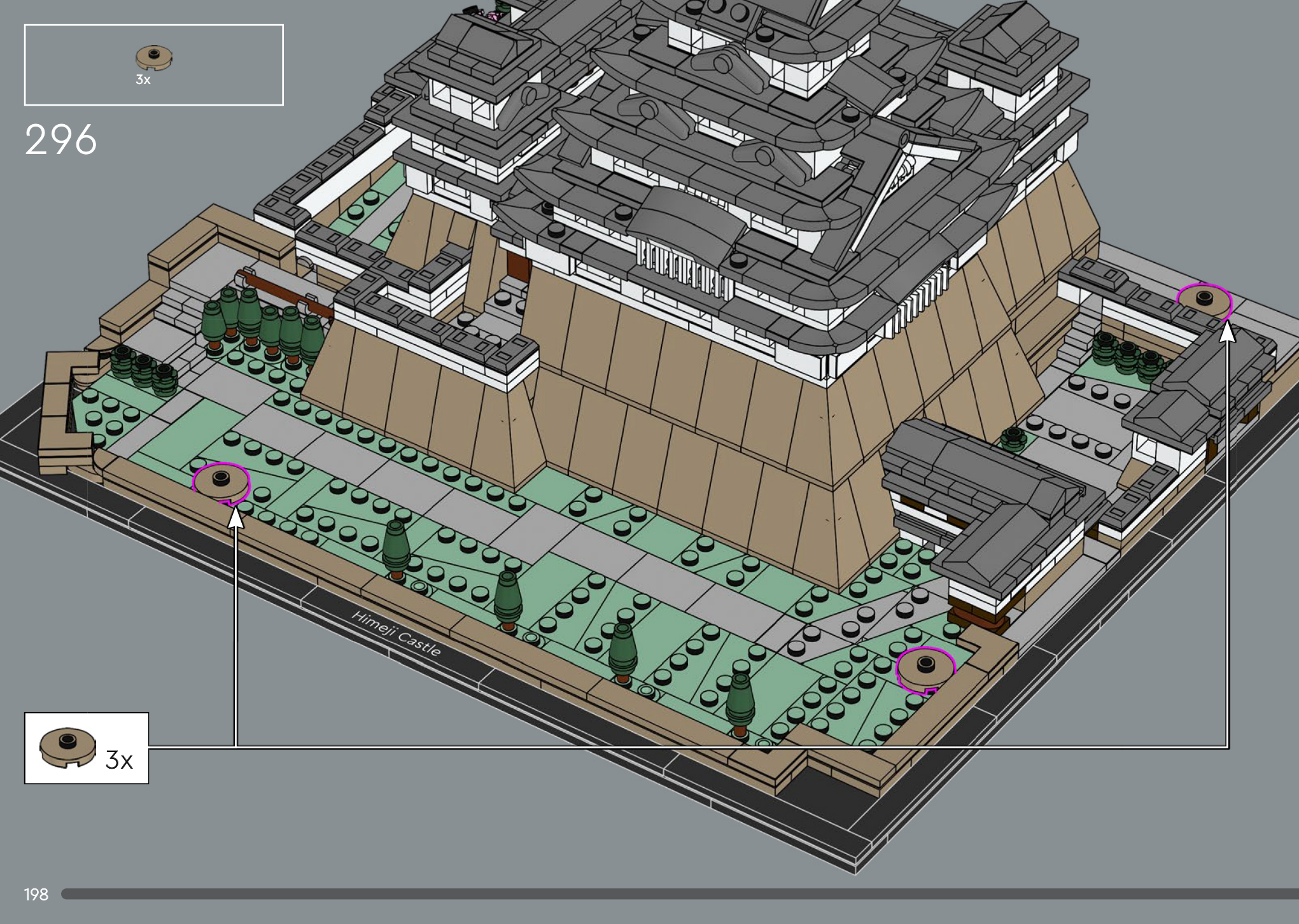

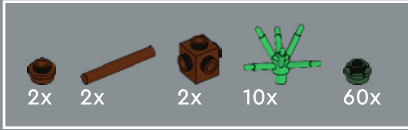
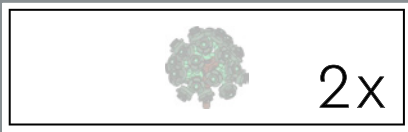

297

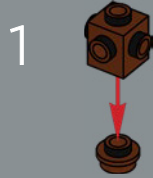
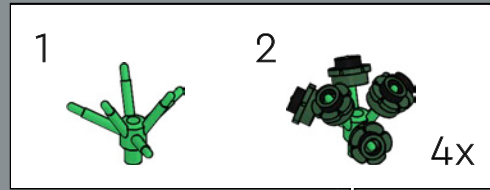
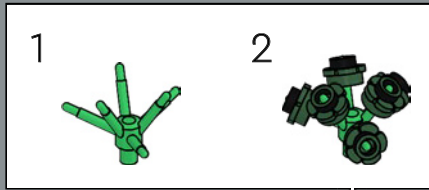



298

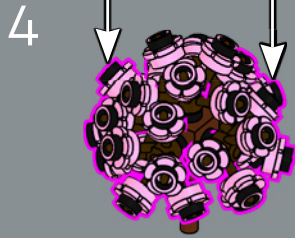
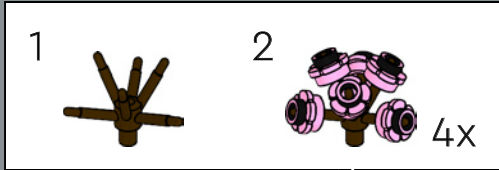
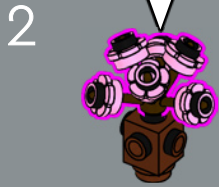
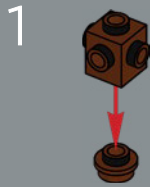
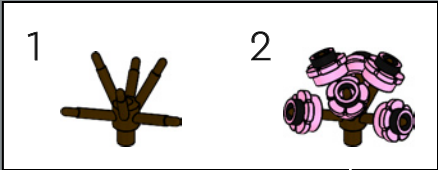



Himeji Castle



299

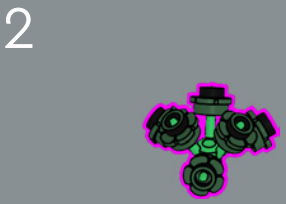
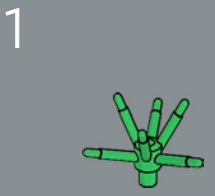
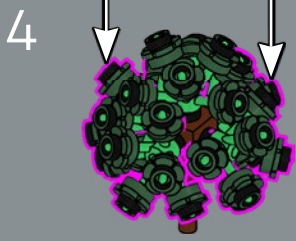
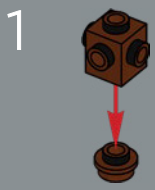
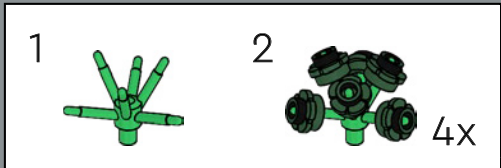
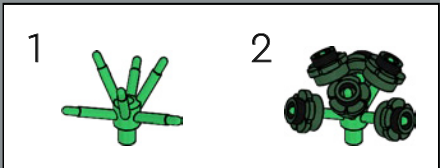

Himeji Castle is also known as The Castle of the White Heron, as it resembles the majestic bird about to take flight.

Le château de Himeji est également connu sous le nom de château du héron blanc, car il ressemble à un oiseau majestueux sur le point de prendre son envol.

Al Castillo de Himeji también se le conoce como Castillo de la Garza Blanca, ya que su aspecto recuerda al de un ejemplar de la majestuosa ave a punto de emprender el vuelo.

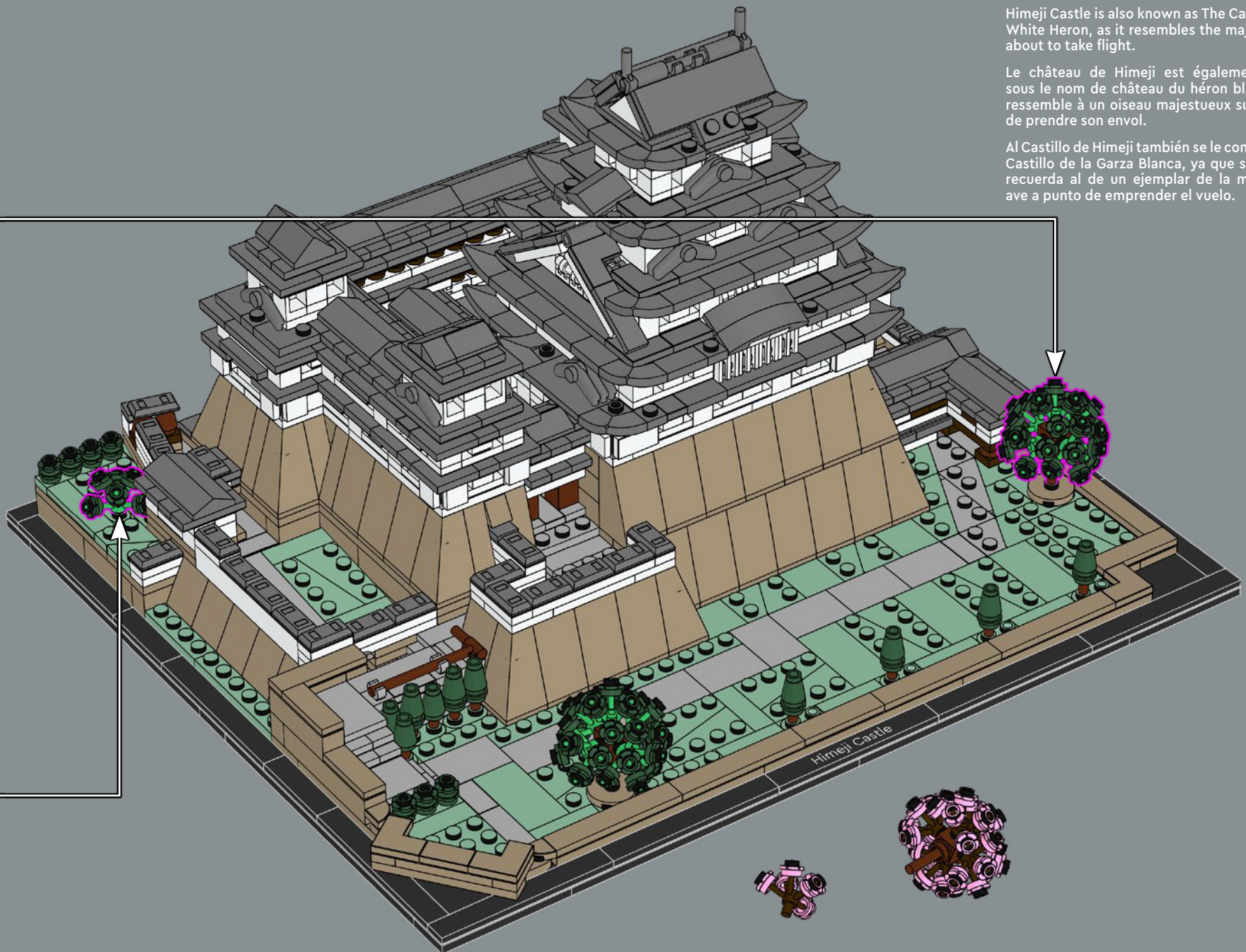

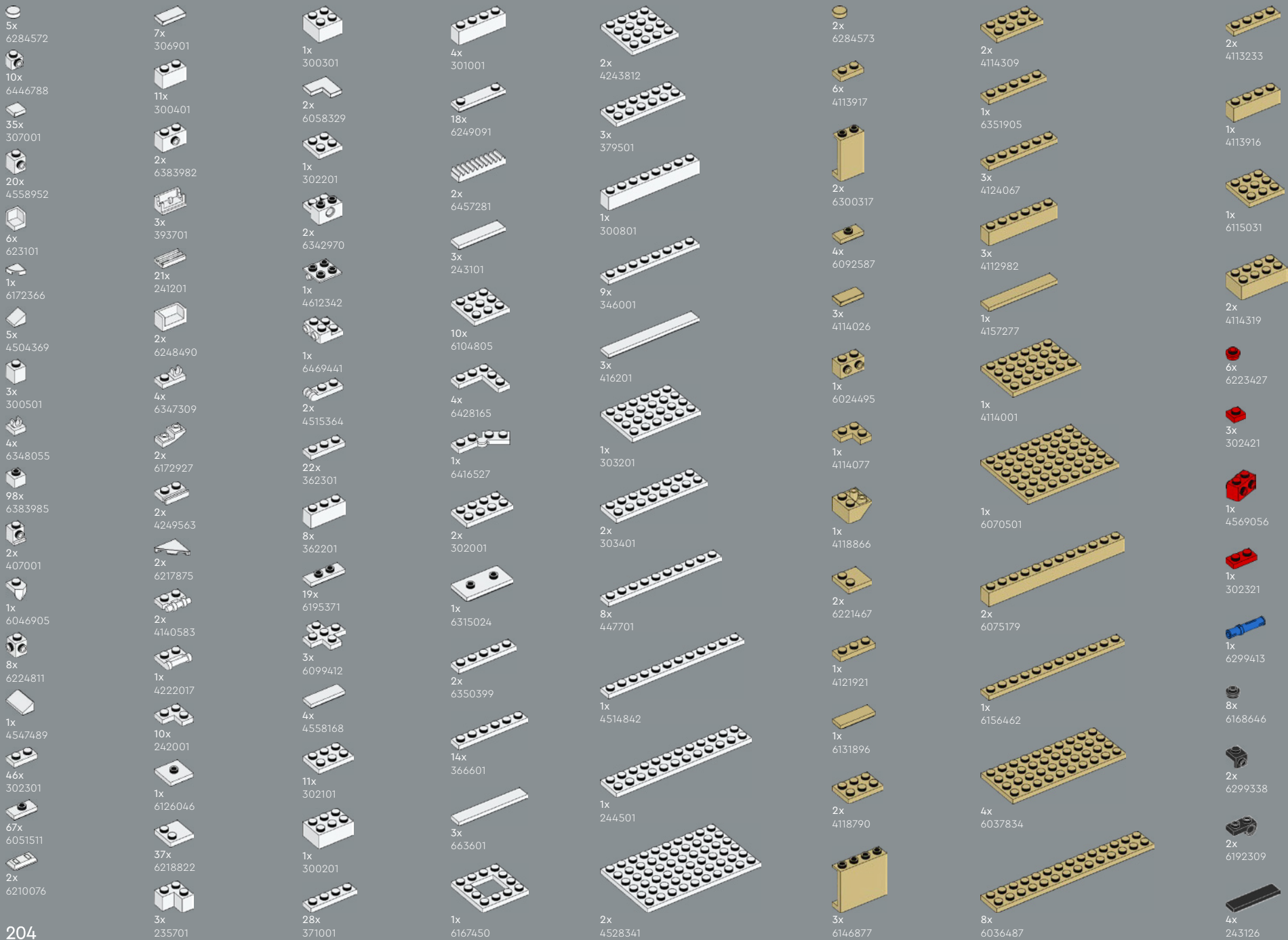



- 1x 6126082
- 1x 4211397
- 2x 4211349
- 1x 4211413
- 4x 4211881
- 1x 6438836
- 12x 4558169
- 12x 6211969
- 3x 4211429
- 16x 6171894
- 2x 4211356
- 5x 6257593
- 2x 4211445
- 5x 4560183
- 2x 4211395
- 1x 4211385
- 2x 4211549
- 4x 4211795
- 5x 4211481

- 1x 4211407
- 4x 4211408
- 6x 4211405
- 6x 4662161
- 4x 6058221
- 6x 6452882
- 1x 6252667
- 2x 6226792
- 1x 6223039
- 36x 6212501
- 4x 6388120
- 4x 4529240
- 2x 6439040
- 1x 4211407
- 4x 4211408
- 6x 4211405
- 6x 4662161
- 4x 6058221
- 6x 6452882
- 1x 6252667
- 2x 6226792
- 1x 6223039
- 36x 6212501
- 4x 6388120
- 4x 4529240
- 2x 6439040

- 2x 6192569
- 2x 6395635
- 4x 4210848
- 9x 4210719
- 2x 6344022
- 6x 4504378
- 2x 6199549
- 2x 6221607
- 4x 6388119
- 1x 4226221
- 6x 4567887
- 29x 6331866
- 20x 6092572
- 12x 4211063
- 6x 4211052
- 2x 4211066
- 2x 4211135

- 3x 6000606
- 9x 4543086
- 20x 6446785
- 1x 6310596
- 12x 6126083
- 6x 6446786
- 1x 4211094
- 43x 6309059
- 2x 4210702
- 18x 6247784
- 1x 6232193
- 21x 6447212
- 4x 4210635
- 1x 4211055
- 60x 6343852
- 8x 4568734

- 1x 4211043
- 3x 6187008
- 4x 4211053
- 3x 4648256
- 2x 6039176
- 41x 6307616
- 6x 4560184
- 3x 4211127
- 10x 6189120
- 4x 4210651
- 2x 4211056
- 2x 6321746
- 1x 6230281

- 2x 4210998
- 1x 4211008
- 1x 4210997
- 1x 4211061
- 2x 6133611
- 1x 6000970
- 1x 6231376
- 2x 6215447
- 3x 6093529
- 25x 6315780
- 3x 6259071
- 4x 6194729
- 3x 4519970



[LEGO.com/service](https://www.LEGO.com/service)



YOU COULD WIN



YOU COULD WIN

Your feedback will help shape the future development of this product series.

Visit:

DU KÖNNTEST GEWINNEN

Dein Feedback trägt zur Weiterentwicklung dieser Produktreihe bei.

Geh auf:

VOUS POURRIEZ GAGNER

Vos commentaires nous aideront à concevoir les futurs produits de cette gamme.

Visitez :

POTRESTI VINCERE TU

La tua opinione ci aiuterà a migliorare la creazione futura di questa linea di prodotti.

Visita:

PUEDES GANAR

Tu opinión contribuirá al futuro de esta serie de productos.

Visita:

轻松获奖

您的反馈将有助于我们在今后改进本产品系列。

请访问:

[LEGO.com/productfeedback](https://www.lego.com/productfeedback)

You also have the chance to win a LEGO® set.

Terms and conditions apply.*

Außerdem hast du die Chance, ein LEGO® Set zu gewinnen.

Es gelten die Teilnahmebedingungen.*

Vous pourriez également gagner un ensemble LEGO®.

Des conditions s'appliquent.*

Hai anche la possibilità di vincere un set LEGO®.

Termini e condizioni sono applicabili.*

También tienes la oportunidad de ganar un set LEGO®.

Aplican términos y condiciones.*

您还有机会赢取乐高®套装。

条款和条件适用。*

*[LEGO.com/productfeedback-terms](https://www.lego.com/productfeedback-terms)

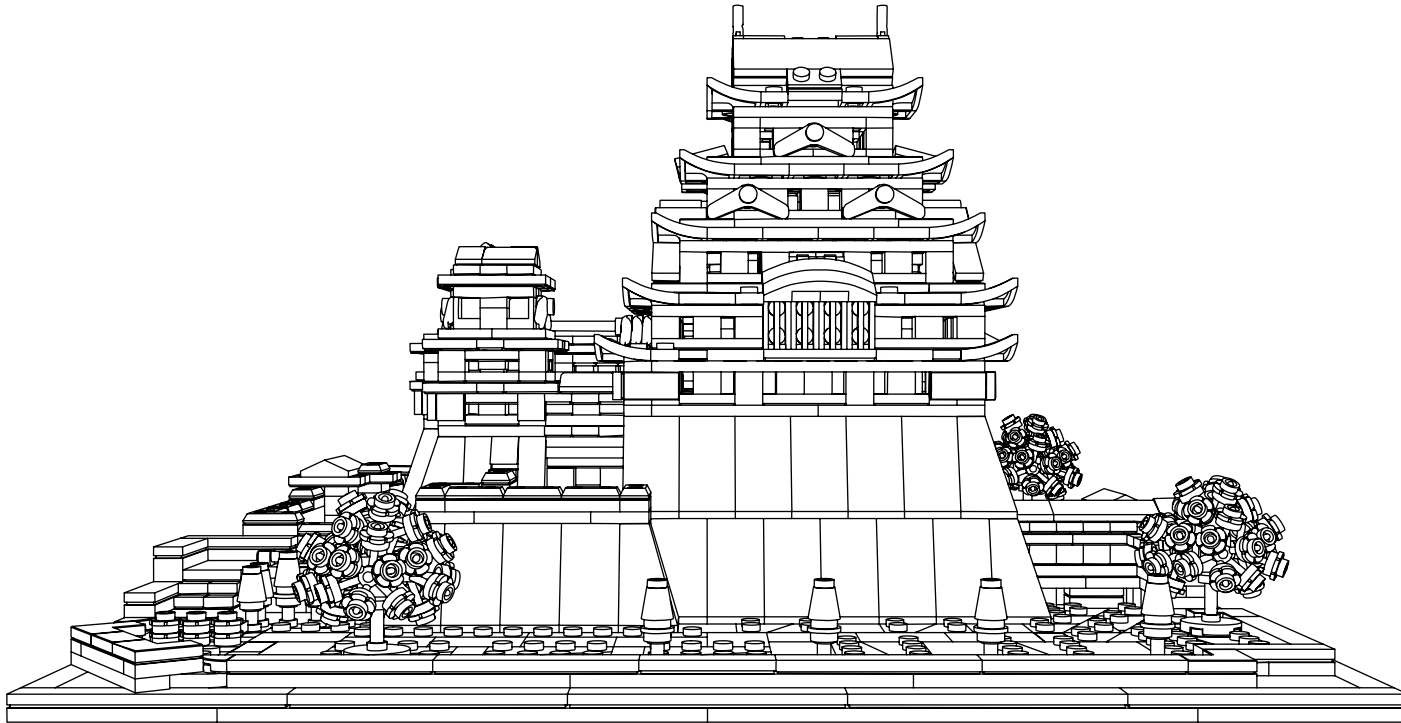

LEGO and the LEGO logo are trademarks of the/sont des marques de commerce du/son marcas registradas de LEGO Group. ©2023 The LEGO Group.

Adam Reed Tucker is the co-developer of the LEGO® Architecture product line.
Adam Reed Tucker est le codéveloppeur de la gamme de produits LEGO® Architecture.
Adam Reed Tucker es el codesarrollador de la línea de productos LEGO® Architecture.

6474321