

# SKSRT480SIS

## 48-INCH DUAL-FUEL PRO RANGETOP WITH SOUS-VIDE AND INDUCTION



### BUILT-IN SOUS VIDE

The industry's first built-in sous vide delivering the ultimate in precision cooking, right on the cooktop. Get professional-style results every time and capture the full, true flavor of foods.

### POWER-UP OR SIMMER DOWN

Two Ultra-High™ Burners deliver 23K BTUs of pure cooking power for better searing and quick stir frying. Two Ultra-Low™ Burners simmer down to maintain temperatures as low as 100° to prepare delicate sauces and sugary confections.

### TWO-ZONE INDUCTION

When the recipe calls for instant temperatures and precision control, two induction zones meet the culinary need. The zones can be combined for use with a griddle, Teppanyaki plate or large cookware.

### BUILT-IN WOK GRATE

The two front burner grates are convertible for round-bottom wok cooking. Stir fry at home with professional-style results.

### Innovation

Wi-Fi-Enabled for ThinQ® Control with iPhone / Android App	Yes
Remote Operations	Yes
Sous Vide Cooking	Yes

### Cooktop Features

Number of Burners / Elements	
Sous Vide + 4 Burners + 2 Zone Induction	
Continuous Grates	2
Wok Convertible Grate (On Front Burners)	Yes
Heating Element "ON" Indicator Light	Yes
LED Power Level Display	Yes

### Cooktop Performance

Simmer – Max. BTU/h (NG)	
Left Rear	310 – 15,000
Right Rear	310 – 15,000
Left Front	650 – 23,000
Right Front	650 – 23,000
Induction Cooktop (W)	
Front (Level 9 / Boost)	2,000 / 3,650
Rear (Level 9 / Boost)	2,000 / 3,650
Flex (Boost)	3,650
Sous Vide Module	800W

# SKSRT480SIS

## 48-INCH DUAL-FUEL PRO RANGETOP WITH SOUS-VIDE AND INDUCTION

### Controls

Knob Cooktop Controls w/LED Display	Yes
-------------------------------------	-----

### Rangetop / General Features

Sealed Gas Burners (Brass)	Yes
Surface Material	Black Porcelain
Stainless Steel Side Panels	Yes

### Technical Specs

Energy Source	Natural Gas and Electric
Alternative Energy Source	LP Gas and Electric
LP Conversion Kit Included	Yes
KW & Amp Rating at 240V	4.7 kW
Required Power Supply	240 / 208V, 60 Hz, 30 Amp

### Dimensions and Weight

Overall Width (inches)	47 7/8"
Overall Height Including Grates (inches)	8 15/16"
Overall Depth Including Knobs (inches)	28 15/16"
Overall Depth without Knobs (inches)	26 3/4"
Net Weight (approx.)	193 lbs.
Shipping Weight (approx.)	261 lbs.

### Accessories

Included Accessories:

Sous Vide Bath, Sous Vide Rack

### Warranty Summary\*

Limited Warranty, Parts & Labor	3 Years
---------------------------------	---------

### Natural Gas or LP

Gas Rangetops are shipped by the factory to operate on natural gas. If the location / job site requires conversion from natural gas to propane (LP), utilize the included LP kit. Conversion must be done by a qualified installer or service technician.

\*These warranties give you specific legal rights and you may have other rights that vary from state to state. For complete warranty details, refer to your Use & Care manual.

# SKSRT480SIS

## 48-INCH DUAL-FUEL PRO RANGETOP WITH SOUS-VIDE AND INDUCTION

### CUTOUT DIMENSIONS

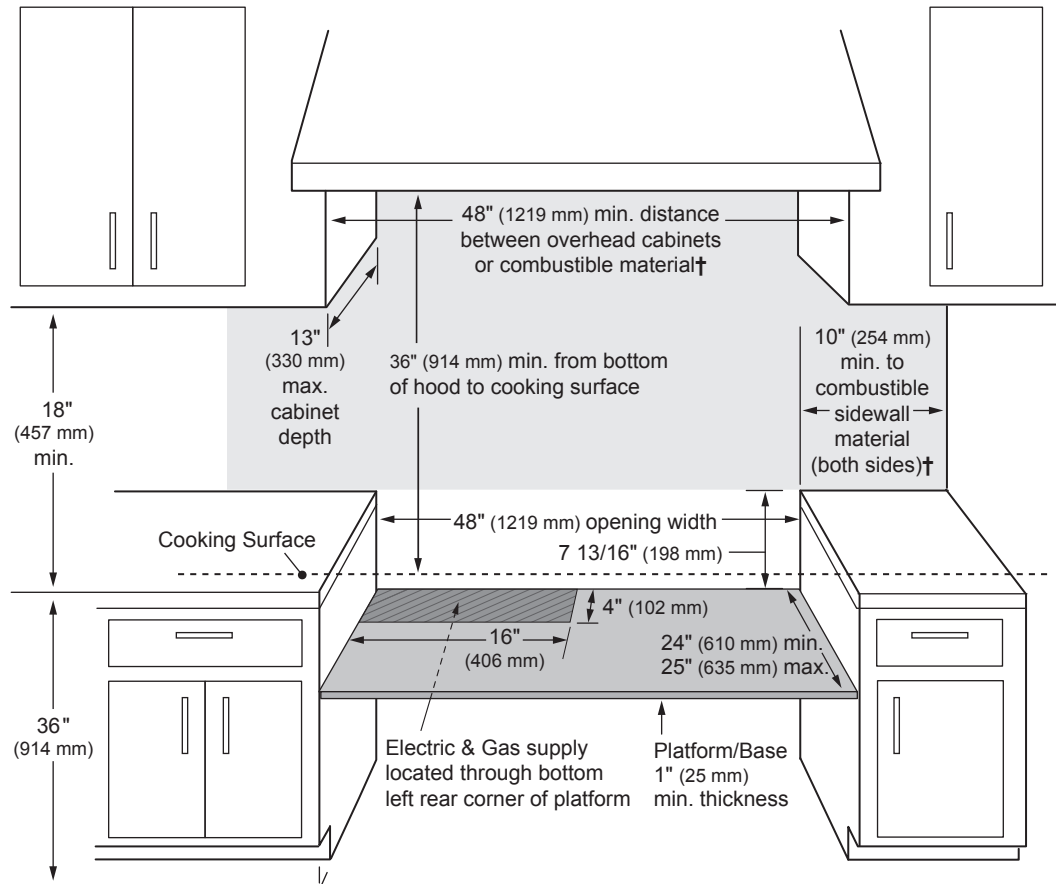

†As defined in the "National Fuel Gas Code" (ANSI Z223.1, Current Edition). Clearances from non-combustible materials are not part of the ANSI Z21.1 scope and are not certified by CSA. Clearances of less than 12" (305 mm) must be approved by the local codes and/or by the local authority having jurisdiction.

NOTE: Shaded area above countertop indicates minimum clearance to combustible surfaces, combustible materials cannot be located within this area. For island installation, 12" (305 mm) minimum clearance from back of rangetop.

### OVERALL PRODUCT DIMENSIONS

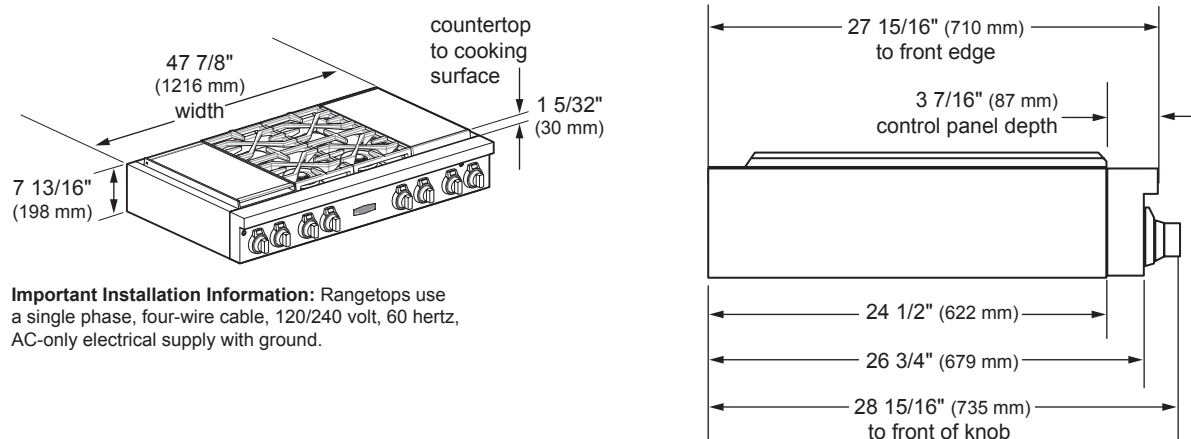

**Important Installation Information:** Rangetops use a single phase, four-wire cable, 120/240 volt, 60 hertz, AC-only electrical supply with ground.