

SKSFD3604P

36-INCH BUILT-IN FRENCH DOOR REFRIGERATOR

SIGNATURE
KITCHEN SUITE



CONVERTIBLE DRAWER

The only built-in refrigerator with 5-mode convertible drawer. Select from five temperature zones: chilled wine, fridge deli, meats and seafood, cold drinks, or drop the temperature all the way down to make it a freezer.

PRECISE PRESERVATION

Ingenious features like an inverter linear compressor and metal interior help to minimize temperature fluctuations to within 1° F to maintain food freshness.

SEAMLESS KITCHEN DESIGN

While food stays perfectly preserved on the inside, the integrity of your kitchen's design lines is protected on the outside thanks to the convertible middle drawer's standard countertop height.

INTERNAL WATER DISPENSER

The internal water dispenser delivers cold, fresh, filtered water with a simple touch.

ECO FRIENDLY

Engineered to reduce environmental impact with HFC / HCFC free refrigerant, insulation and recyclable materials.

Style

Door Style	Panel Ready
Interior Cabinet Finish	Metal

Innovation

Wi-Fi-Enabled for SmartThinQ® Control with iPhone / Android App	Yes
Inverter Linear Compressor	Yes

Performance

Evaporator / Compressor System	Dual
Speed Chill	Yes
Speed Freeze	Yes
Adaptive Defrost	Yes

Modes

Sabbath, Ice Plus, Demo, Icemaker On / Off, Power On / Off, Temp Control, Water Filter Reset, Smart Diagnosis, WiFi, Smart Grid

Internal Water Dispenser	Yes
Water Filter (6 Months)	Yes

Capacity and Storage

Total Capacity (cu. ft.)	19.3
Full-Extension Freezer Storage Drawer	Soft Close / Self Close
Full-Extension Convertible Drawer	Soft Close / Self Close

Convertible Drawer Modes

Freezer (-6° to 8° F), Meat / Seafood (29° F), Cold Drinks (33° F), Fridge / Deli (37° F), Chilled Wine (42° F)

Convertible Drawer Dividers	2
Storage Shelves	2 Adjustable w/ LED True-View™ Lighting, 1 Fixed
Lift and Go™ Crisper / Storage Drawers	2 Soft Close / Self Close
Aluminum Framed Lift and Go™ Door Bins with Removable Inserts (Holds 2-Liter Bottles)	6 Adjustable
Removable Ice Bucket Storage Volume	5.5 lbs.

© 2019 Signature Kitchen Suite. All rights reserved. Design, features and specifications are subject to change without notice. Specifications are for planning purposes only. Consult the product's installation instructions for final dimensional data and other details prior to making cutouts or custom panels. Consult with a heating and ventilation engineer for your specific ventilation requirements. Non-metric weights and measurements are approximate. Smart features require Internet access.
1-855-790-6655 | www.signaturekitchensuite.com

SKSFD3604P

36-INCH BUILT-IN FRENCH DOOR REFRIGERATOR

General Features

Digital Controls w/White LED Display	Yes
Water Filter Indicator	Yes
Ice Production (24 Hrs.)	3.5 lbs.
Ice On / Off	Yes
Hidden LED True-View™ Interior Lighting	Yes
Operating Temperatures	
Refrigerator: 33° to 46° F	
Middle Drawer: Convertible – 5 Preset Modes	
Freezer Drawer: -6° to 8° F	
Maximum Sound Level	39 dBA
Star-K Certified Sabbath Mode	Yes
ENERGY STAR® Qualified	Yes

Installation Features

Four Point Front Adjustable with 8 Wheels	Yes
Attachment Method to Cabinetry	Top with No Visible Screws
Front Serviceable	Yes
Anti-tip Bracket Included	Yes

Technical Specs

Required Power Supply	115 V, 60 Hz, 15 or 20 Amp
Plug Type	3-Prong
Power Cord Length	86 1/2"

Dimensions and Weight

Overall Width (inches)	35 3/4"
Overall Height (inches)	83 1/2" Min. – 84 1/2" Max.
Overall Depth Without Panel or Handles (inches)	23 7/8"
Net Weight (approx.)	483 lbs.
Shipping Weight (approx.)	532 lbs.

Optional Accessories

Stainless Steel Panels / Handles / Toekick Kit	SKSPK360FS
Retrofit Frame Kit	SKSFK800CS
Brushed Aluminum Handle Medium – 31 11/16"	SKSHK310HS
Replacement Water Filter	LT1000P-S

Warranty Summary*

Limited Warranty, Parts & Labor	2 Years
Additional 1 Year When Product Registration is Completed Online with Owner Opt-in for WiFi Monitoring	Yes
Limited Warranty on Sealed System, Parts and Labor	5 Years
Limited Warranty on Sealed System, Parts Only	10 Years

*These warranties give you specific legal rights and you may have other rights that vary from state to state. For complete warranty details, refer to your Use & Care manual.

SKSFD3604P

36-INCH BUILT-IN FRENCH DOOR REFRIGERATOR

CUTOUT DIMENSIONS – FLUSH OR PROUD INSTALLATION

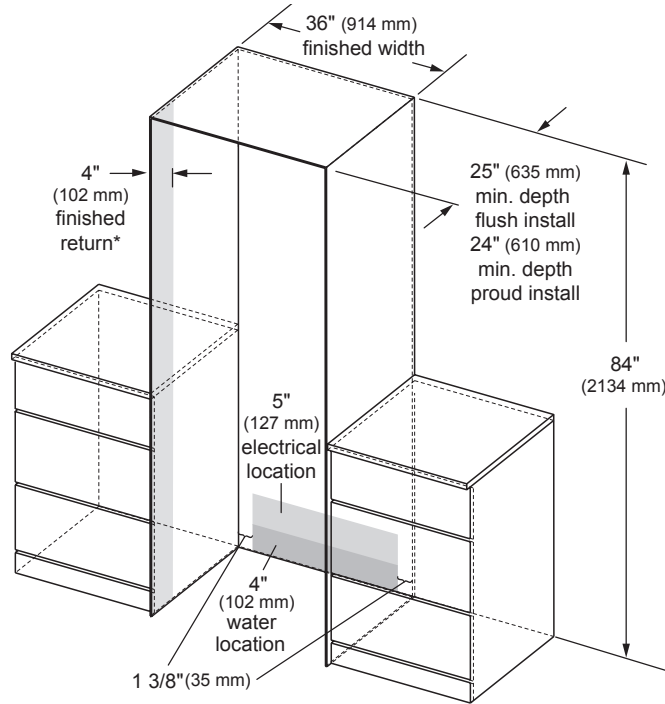

*A minimum 4" (102 mm) finished return that matches the cabinet exterior is recommended on all sides and the top of the cutout opening. The shaded area will be visible after installation.

INSTALLATION CLEARANCES

TOP VIEW

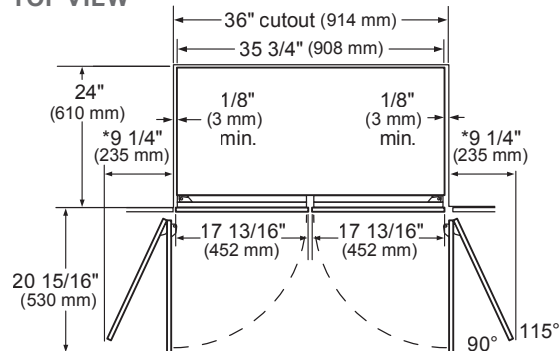

*Door handle must be added to this dimension.

**Varies depending on the thickness of the custom cabinet panel. 3/4" (19 mm) is relevant when using the Stainless Steel Door Panel Kit (optional accessory).

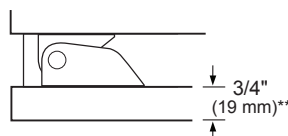

Notes

Refrigerator can be installed flush or proud with 3/4" custom panel or optional stainless steel panel kit.

Flush – With a 25" (635 mm) cutout depth, the front face of the refrigerator fits flush with 25" (635 mm) depth adjacent cabinets.

Proud – With a 24" (610 mm) depth cutout, the front face of the refrigerator extends approximately 3/4" (19 mm) beyond 24" (610 mm) depth adjacent cabinets.

Electrical

A 115V, 60Hz., 15 or 20 amp power supply is required. An individual properly grounded branch circuit or circuit breaker is recommended. Install a properly grounded 3-prong electrical receptacle recessed into the back wall. Electrical must be located on rear wall as shown.

Note: GFI (ground fault interrupter) is not recommended.

Water Line

A cold water supply is required for automatic icemaker operation. Water pressure must be between 20 and 120 p.s.i.

Tubing should be long enough to extend to the front of the refrigerator. Allow enough tubing to accommodate a bend leading into the water line connection.

Water line can enter an opening through floor or back wall.

Install a shut-off valve between the icemaker water valve and cold water supply in the home.

Notes

Door Swing Clearances – The installation must allow for clearances to adjacent walls or cabinets. This refrigerator is equipped with a 2-position door stop. The factory-set 115° door swing can be adjusted to 90° if clearance to adjacent cabinets or walls is restricted.

Door Handle Clearances – The Door Handle depth must be added to the dimension noted to determine the total clearances required from adjacent cabinets or walls. This clearance will vary depending on the custom handle used. When using the Stainless Steel Door Panel Kit w/ Handles or the Brushed Aluminum Handles (optional accessories), the door handle clearance with door open 115° is 12" (305 mm).

SKSFD3604P
36-INCH BUILT-IN FRENCH DOOR
REFRIGERATOR

OVERALL PRODUCT DIMENSIONS

FRONT VIEW

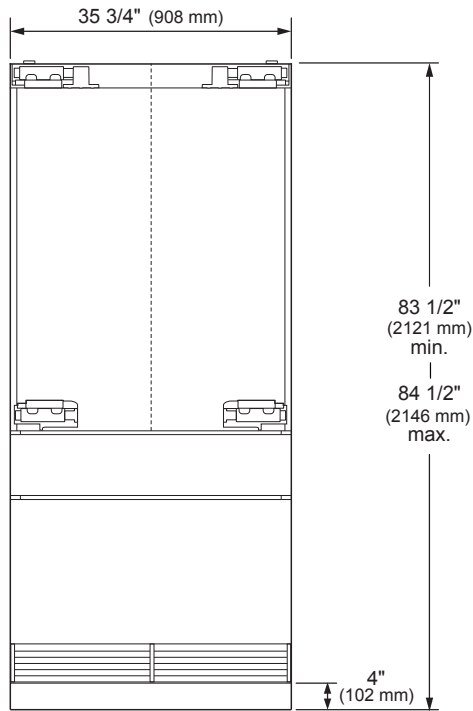

SIDE VIEW

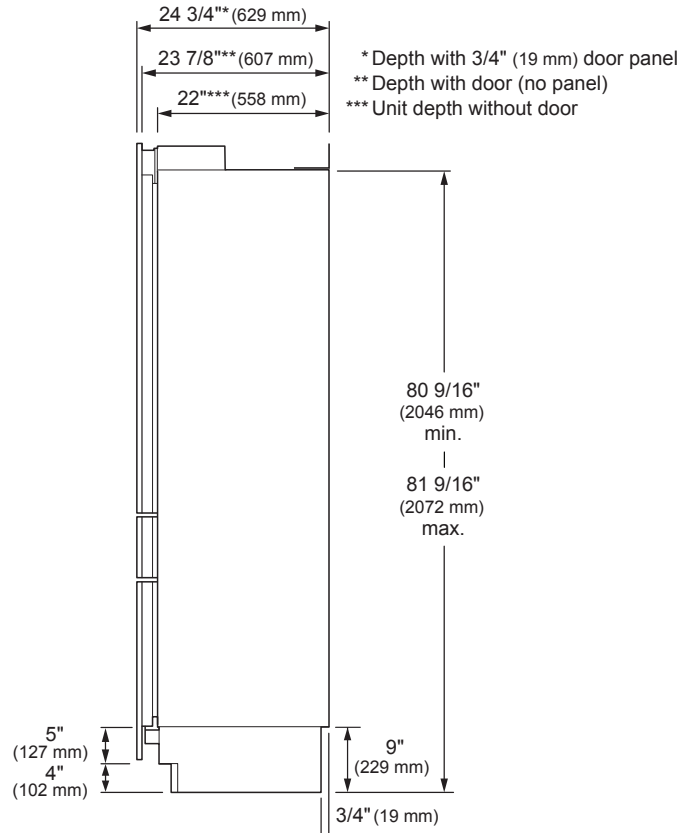

SKSFD3604P

36" INTEGRATED FRENCH DOOR REFRIGERATOR

CUSTOM PANEL DIMENSIONS – FLUSH INSTALLATION

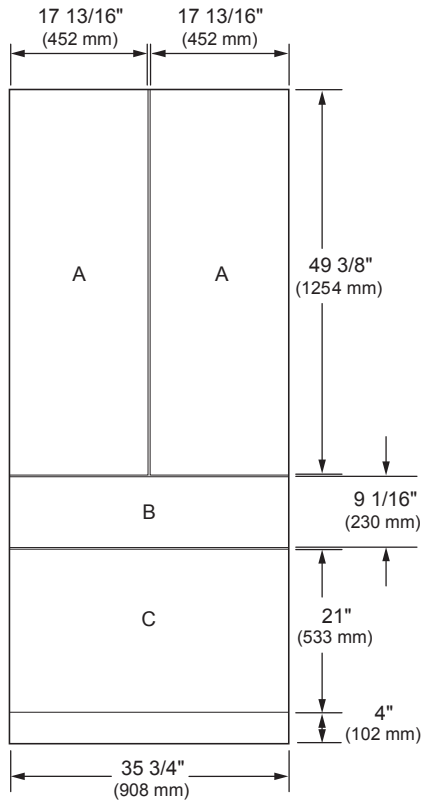

Notes

These units are designed to be customized with decorative panels. Field-installed custom door panels or an optional Stainless Steel Panel Kit is required.

For Custom Panels: Use templates provided with units to pre-drill holes for mounting panel brackets (provided with unit). Adjustment screws and instructions also provided with units.

Maximum Panel Weight:

- A – Fresh food door panels: 33 lbs.
- B – Convertible drawer panel: 22 lbs.
- C – Freezer drawer panel: 33 lbs.

Design Tips

4" (102 mm) will be visible on the interior sides of the furniture return. It is recommended that both sides of each cutout panel be finished to match the cabinet exterior.

If using custom panels, a custom toe kick is required. The bottom of case is unfinished.

Door Handles: Handles are not included with the refrigerator. Custom handles are required for installation. Brushed Aluminum Handles are available as an optional accessory.

OPTIONAL ACCESSORIES – FLUSH OR PROUD INSTALLATION

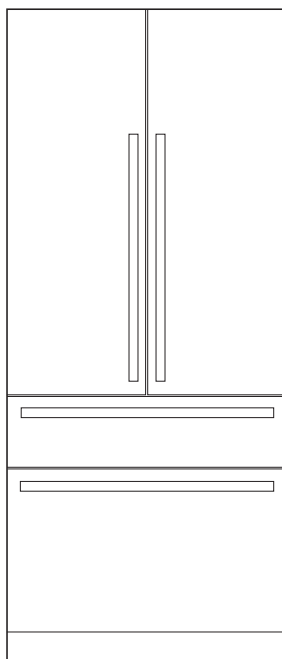

SKSPK360FS – Stainless Steel Panel Kit for 36-inch Built-in French Door Refrigerator

This refrigerator can be installed with an optional Stainless Steel Panel Kit. Kit includes two fresh food door panels, one convertible drawer panel, one freezer drawer panel, one toe kick and four handles.

SKSFK800CS – Frame Kit

This unit can be installed in a 24" (610 mm) deep cutout with an optional frame kit. This kit includes two 80" (2032 mm) brushed aluminum side trim pieces. Each trim piece is 5" (127 mm) deep with a 1/8" (3 mm) front face.

Handles for Use With Custom Panels

SKSHK310HS – 31 11/16" (805 mm) Medium Handle – Brushed Aluminum

Design Tips

The Stainless Steel Panel Kit may be used in a flush 25" (635 mm) cutout depth installation or in a proud 24" (610 mm) cutout depth installation.

For retrofit/replacement installations where the existing cutout is 24" (610 mm) deep, the optional frame kit is recommended.