



# SERVICE MANUAL

Whirlpool<sup>®</sup>, Maytag<sup>®</sup>, Amana<sup>®</sup>, & IKEA<sup>®</sup>  
Refrigerators



---

## FORWARD

This Whirlpool Service Manual (Part No. W11296289), provides the In-Home Service Professional with service information for the “Whirlpool®, Maytag®, Amana®, and IKEA® Refrigerators.”

The Wiring Diagram used in this Service Manual is typical and should be used for training purposes only. Always use the Wiring Diagram supplied with the product tech sheet when servicing the refrigerator.

For specific operating and installation information on the model being serviced, refer to the “Use and Care Guide” or “Installation Instructions” provided with the refrigerator.

---

## GOALS AND OBJECTIVES

The goal of this Service Manual is to provide information that will enable the In-Home Service Professional to properly diagnose malfunctions and repair the “Whirlpool®, Maytag®, Amana®, and IKEA® Refrigerators.”

The objectives of this Service Manual are to:

- Understand and follow proper safety precautions.
- Successfully troubleshoot and diagnose malfunctions.
- Successfully perform necessary repairs.

WHIRLPOOL CORPORATION assumes no responsibility for any repairs made on our products by anyone other than authorized In-Home Service Professionals.

©2018 Whirlpool Corporation. Benton Harbor, MI 49022

---

# TABLE OF CONTENTS

## Whirlpool®, Maytag®, Amana®, & IKEA® Refrigerators

<b>SECTION 1: GENERAL INFORMATION</b> .....	<b>1-01</b>
REFRIGERATOR SAFETY .....	1-02
PRODUCT SPECIFICATIONS.....	1-03
PRODUCT FEATURES.....	1-11
MODEL & SERIAL NUMBER LOCATION.....	1-12
TECH SHEET LOCATION .....	1-12
MODEL NOMENCLATURE .....	1-13
<b>SECTION 2: DIAGNOSTICS</b> .....	<b>2-01</b>
SAFETY .....	2-02
DIAGNOSTICS MODE .....	2-03
SALES DEMO MODE .....	2-09
<b>SECTION 3: COMPONENT TESTING</b> .....	<b>3-01</b>
SAFETY .....	3-02
WIRING DIAGRAM .....	3-03
COMPONENT LOCATION .....	3-09
<b>SECTION 4: COMPONENT ACCESS</b> .....	<b>4-01</b>
REMOVING THE FRONT WHEEL.....	4-02
ACCESSING INTERIOR OF UNIT .....	4-03
REMOVING THE DAMPER.....	4-03
REMOVING THE FREEZER SHELF .....	4-05
ACCESSING THE FREEZER EVAPORATOR AND COMPONENTS.....	4-05
ACCESSING THE DISPENSER AREA (REMOVING UI).....	4-07
ACCESSING THE MACHINE COMPARTMENT .....	4-10

---

# Notes



# Section 1: General Information

This section provides general safety, parts, and information for the “Whirlpool®, Maytag®, Amana®, and IKEA® Refrigerators.”

- Refrigerator Safety
- Product Specifications
- Product Feature
  - Control Panel
- Model & Serial Label
  - Location
  - Model Nomenclature
- Tech Sheet Location

# Refrigerator Safety

### Your safety and the safety of others are very important.

We have provided many important safety messages in this manual and on your appliance. Always read and obey all safety messages.



This is the safety alert symbol.

This symbol alerts you to potential hazards that can kill or hurt you and others.

All safety messages will follow the safety alert symbol and either the word “DANGER” or “WARNING.”

These words mean:

**⚠ DANGER**

**You can be killed or seriously injured if you don't immediately follow instructions.**

**⚠ WARNING**

**You can be killed or seriously injured if you don't follow instructions.**

All safety messages will tell you what the potential hazard is, tell you how to reduce the chance of injury, and tell you what can happen if the instructions are not followed.

## IMPORTANT SAFETY INSTRUCTIONS

**WARNING:** To reduce the risk of fire, electric shock, or injury when using your refrigerator, follow these basic precautions:

- Plug into a grounded 3 prong outlet.
- Connect to a potable water supply only.
- Do not remove ground prong.
- Do not use an adapter.
- Do not use an extension cord.
- Disconnect power before servicing.
- Replace all parts and panels before operating.
- Remove doors from your old refrigerator
- This appliance is not intended for use by persons (including children) with reduced physical, sensory or mental capabilities, or lack of experience and knowledge, unless they have been given supervision or instruction concerning use of the appliance by a person responsible for their safety.
- Remove doors from your old refrigerator.
- Use nonflammable cleaner.
- Keep flammable materials and vapors, such as **gasoline, away from refrigerator.**
- Use two or more people to move and install refrigerator.
- Disconnect power before installing ice maker (on icemaker kit ready models only).
- Use a sturdy glass when dispensing ice (on some models).
- Do not hit the refrigerator glass doors (on some models).
- Children should be supervised to ensure that they do not play with the appliance.

**SAVE THESE INSTRUCTIONS**

## Product Specifications

### Amana® 36" Side by Side Refrigerator with Dual Pad External Ice and Water Dispenser

AHAM Volumes and Shelf Area	
Freezer Volume (Cu Ft)	9.11
Refrigerator Volume (Cu Ft)	15.46
Total Volume (Cu Ft)	24.6
Dimensions	
Capacity (FT <sup>3</sup> , Cu Ft)	24.57
Cabinet Width (IN, inches)	35 <sup>1</sup> / <sub>2</sub>
Cutout Depth (IN, inches)	27 <sup>1</sup> / <sub>2</sub>
Cutout Height (IN, inches)	69 <sup>3</sup> / <sub>8</sub>
Cutout Width (IN, inches)	36
Depth Closed Excluding Handles (IN, inches)	31 <sup>5</sup> / <sub>8</sub>
Depth Closed Including Handles (IN, inches)	34 <sup>1</sup> / <sub>8</sub>
Depth Excluding Doors (IN, inches)	28
Depth With Door Open 90 Degree (IN, inches)	49 <sup>3</sup> / <sub>8</sub>
Depth (IN, inches)	34 <sup>5</sup> / <sub>8</sub>
Height to Top of Cabinet (IN, inches)	68 <sup>5</sup> / <sub>8</sub>
Height to Top of Door Hinge (IN, inches)	69 <sup>1</sup> / <sub>4</sub>
Height (IN, inches)	69 <sup>5</sup> / <sub>8</sub>
Width (IN, inches)	35 <sup>7</sup> / <sub>8</sub>
Description	
Type of Refrigerator	Side by Side
Details	
Advance Foam Insulation	NA
Cooling Type	Single Evaporator
Exterior	
Base Grille Color	Black/White
Cabinet Color	Black/White
Cabinet Finish	Textured
Door Color	Black/Stainless Steel/White
Door Finish	Smooth
Door Style	Contour
Door Swing	NA
Handle Color	Black/Stainless Steel/White
Handle Material	Metal
Handle Type	Reach Through Handle
Hidden Hinge	Yes
Number of Doors	2
Levelers	2 Black
Wheels	4-Natural

## GENERAL INFORMATION

Controls	
Automatic Defrost	Yes
Location of Controls	Exterior Dispenser
Temperature Range	-5/+5 FC 33/45 RC
Type of Control	Electronic Touch
Water Filter Indicator/Reset	Yes
Connected Appliances	No
Refrigerator Compartment	
Number of Interior Shelves	4
Conventional Shelves	1 Fixed Full-Width Glass 3 Adjustable Full-Width Glass
Spill-Proof Glass Shelves	No
Shelf Supports	Molded
Humidity-Controlled Drawers	1 Full-Width
Non-Climate Control Drawers	1 Full-Width
Temperature-Controlled Drawers	No
Door Bins	1 Dairy 1 Fixed Full-Width 3 Adjustable Gallon
Supplementary Containers	No
Lighting	Incandescent
Liner Finish	White Opaque
Freezer Compartment	
Door Type	Swing
Shelves	3 Fixed Full-Width Wire
Freezer Number of Shelves	3
Freezer Drawer/Basket	1 Full-Width Lower Plastic
Door Bins	1 Fixed Partial 3 Fixed Full-Width
Light	Incandescent
Dispenser	
Dispenser Type	Exterior Ice and Water
Dispenser Options	Filtered Water Measured/Metered Fill
Types of Ice	Crushed/Cubed
Dispenser Pad Color	Black
Icemaker	
Icemaker	Factory Installed
Icemaker Location	Freezer
Electrical	
Amps	7.2
Hz	60
Volts	110

## Whirlpool® 36" Wide Side by Side Refrigerator - 25 Cu Ft

AHAM Volumes and Shelf Area	
Freezer Volume (Cu Ft)	9.11
Refrigerator Volume (Cu Ft)	15.46
Total Volume (Cu Ft)	24.6
Dimensions	
Capacity (FT3, Cu Ft)	24.57
Cabinet Width (IN, inches)	35 <sup>7</sup> / <sub>8</sub>
Depth Closed Excluding Handles (IN, inches)	31 <sup>5</sup> / <sub>8</sub>
Depth Closed Including Handles (IN, inches)	33 <sup>5</sup> / <sub>8</sub>
Depth Excluding Doors (IN, inches)	28
Depth With Door Open 90 Degree (IN, inches)	49 <sup>5</sup> / <sub>16</sub>
Depth (IN, inches)	33 <sup>5</sup> / <sub>8</sub>
Height to Top of Cabinet (IN, inches)	68 <sup>5</sup> / <sub>8</sub>
Height to Top of Door Hinge (IN, inches)	69 <sup>1</sup> / <sub>4</sub>
Height (IN, inches)	69 <sup>5</sup> / <sub>8</sub>
Width (IN, inches)	35 <sup>7</sup> / <sub>8</sub>
Description	
Type of Refrigerator	Side by Side
Details	
Advance Foam Insulation	NA
Cooling Type	Single Evaporator
Exterior	
Base Grille Color	White/Black/Grey/Biscuit
Cabinet Color	White/Black/Grey/Biscuit
Cabinet Finish	Textured
Door Color	White/Black/Stainless Steel/Sunset Bronze/Fingerprint Resistant Stainless Steel/Biscuit
Door Finish	Smooth
Door Style	Contour
Door Swing	NA
Handle Color	White/Black/Stainless Steel/Biscuit/Fingerprint Resistant Stainless Steel
Handle Material	Stainless Steel
Handle Type	Reach Through Handle
Hidden Hinge	Yes
Number of Doors	2
Controls	
Automatic Defrost	Yes
Location of Controls	Interior Up Front/Interior/Exterior Dispenser
Type of Control	Electronic Touch/Tap Touch
Water Filter Indicator/Reset	Yes
Connected Appliances	No

## GENERAL INFORMATION

Refrigerator Compartment	
Number of Interior Shelves	4
Conventional Shelves	1 Fixed Full-Width Glass 3 Adjustable Full-Width Glass
Shelf Supports	Molded
Humidity-Controlled Drawers	1 Full-Width
Non-Climate Control Drawers	1 Full-Width
Temperature-Controlled Drawers	No
Door Bins	1 Dairy 1 Fixed Full-Width 3 Adjustable Gallon
Supplementary Containers	No/Can Caddy Bin Utility Compartment
Lighting	LED
Freezer Compartment	
Door Type	Swing
Shelves	1 Fixed Full-Width Plastic 4 Fixed Full-Width Wire or 3 Fixed Full-Width Glass
Freezer Number of Shelves	3 or 4 or 5
Freezer Drawer/Basket	1 Full-Width Lower Plastic
Door Bins	4 Fixed Full-Width or 1 Fixed Partial 3 Fixed Full-Width
Light	LED
Dispenser	
Dispenser Type	No Dispenser/Exterior Ice and Water
Dispenser Options	Filtered Water Ice Dispenser Lock Night Light
Types of Ice	Crushed/Cubed
Icemaker	
Icemaker	Optional/Factory Installed
Icemaker Kit Part Number	ECKMF95
Icemaker Location	Freezer
Electrical	
Hz	60

## Whirlpool® 33" Wide Side by Side Refrigerator - 22 Cu Ft

AHAM Volumes and Shelf Area	
Freezer Volume (Cu Ft)	7.07
Refrigerator Volume (Cu Ft)	14.65
Total Volume (Cu Ft)	21.7
Dimensions	
Capacity (FT3, Cu Ft)	21.72
Cabinet Width (IN, inches)	32 <sup>3</sup> / <sub>4</sub>
Depth Closed Excluding Handles (IN, inches)	31 <sup>5</sup> / <sub>8</sub>
Depth Closed Including Handles (IN, inches)	33 <sup>5</sup> / <sub>8</sub>
Depth Excluding Doors (IN, inches)	28
Depth With Door Open 90 Degree (IN, inches)	49 <sup>5</sup> / <sub>16</sub>
Depth (IN, inches)	33 <sup>5</sup> / <sub>8</sub>
Height to Top of Cabinet (IN, inches)	65 <sup>5</sup> / <sub>8</sub>
Height to Top of Door Hinge (IN, inches)	66 <sup>1</sup> / <sub>4</sub>
Height (IN, inches)	66 <sup>5</sup> / <sub>8</sub>
Width (IN, inches)	32 <sup>3</sup> / <sub>4</sub>
Description	
Type of Refrigerator	Side by Side
Details	
Advance Foam Insulation	NA
Cooling Type	Single Evaporator
Exterior	
Base Grille Color	White/Black/Grey
Cabinet Color	White/Black/Grey
Cabinet Finish	Textured
Door Color	White/Black/Stainless Steel
Door Finish	Smooth
Door Style	Contour
Door Swing	NA
Handle Color	White/Black/Stainless Steel
Handle Material	Metal
Handle Type	Reach Through Handle
Hidden Hinge	Yes
Number of Doors	2
Controls	
Automatic Defrost	Yes
Location of Controls	Interior
Type of Control	Electronic Touch
Connected Appliances	No

## GENERAL INFORMATION

Refrigerator Compartment	
Number of Interior Shelves	4
Conventional Shelves	1 Fixed Full-Width Glass 3 Adjustable Full-Width Glass
Shelf Supports	Molded
Humidity-Controlled Drawers	1 Full-Width
Non-Climate Control Drawers	1 Full-Width
Temperature-Controlled Drawers	No
Door Bins	1 Dairy 1 Fixed Full-Width 3 Adjustable Gallon
Supplementary Containers	No
Lighting	LED
Liner Finish	White Opaque
Freezer Compartment	
Door Type	Swing
Shelves	4 Fixed Full-Width Wire
Freezer Number of Shelves	4
Freezer Drawer/Basket	1 Full-Width Lower Plastic
Door Bins	4 Fixed Full-Width
Light	LED
Dispenser	
Dispenser Type	No Dispenser
Icemaker	
Icemaker	Optional
Icemaker Location	Freezer
Icemaker Kit Part Number	ECKMF95
Electrical	
Amps	7.2
Hz	60
Volts	110



## Whirlpool® 33" Wide Side by Side Refrigerator - 21 Cu Ft

AHAM Volumes and Shelf Area	
Freezer Volume (Cu Ft)	6.77
Refrigerator Volume (Cu Ft)	14.65
Total Volume (Cu Ft)	21.4
Dimensions	
Capacity (FT3, Cu Ft)	21.4
Cabinet Width (IN, inches)	32 <sup>3</sup> / <sub>4</sub>
Depth Closed Excluding Handles (IN, inches)	31 <sup>5</sup> / <sub>8</sub>
Depth Closed Including Handles (IN, inches)	33 <sup>5</sup> / <sub>8</sub>
Depth Excluding Doors (IN, inches)	28
Depth With Door Open 90 Degree (IN, inches)	49 <sup>5</sup> / <sub>16</sub>
Depth (IN, inches)	33 <sup>5</sup> / <sub>8</sub>
Height to Top of Cabinet (IN, inches)	65 <sup>5</sup> / <sub>8</sub>
Height to Top of Door Hinge (IN, inches)	66 <sup>1</sup> / <sub>4</sub>
Height (IN, inches)	66 <sup>5</sup> / <sub>8</sub>
Width (IN, inches)	32 <sup>3</sup> / <sub>4</sub>
Description	
Type of Refrigerator	Side by Side
Details	
Advance Foam Insulation	NA
Cooling Type	Single Evaporator
Exterior	
Base Grille Color	White/Black/Grey/Biscuit
Cabinet Color	White/Black/Grey/Biscuit
Cabinet Finish	Textured/Smooth
Door Color	White/Black/Stainless Steel/Fingerprint Resistant Stainless Steel/Biscuit
Door Finish	Smooth
Door Style	Contour
Door Swing	NA
Handle Color	White/Black/Stainless Steel/Biscuit/Print Resist Stainless Steel
Handle Type	Reach Through Handle
Hidden Hinge	Yes
Number of Doors	2
Controls	
Automatic Defrost	Yes
Location of Controls	Exterior Dispenser/Interior Up Front
Temperature Range	-5/+5 FC 33/45 RC
Type of Control	Electronic Touch
Water Filter Indicator/Reset	Yes
Connected Appliances	No

## GENERAL INFORMATION

Refrigerator Compartment	
Number of Interior Shelves	4
Conventional Shelves	1 Fixed Full-Width Glass 3 Adjustable Full-Width Glass
Shelf Supports	Molded
Humidity-Controlled Drawers	1 Full-Width
Non-Climate Control Drawers	1 Full-Width
Temperature-Controlled Drawers	No
Door Bins	1 Dairy 1 Fixed Full-Width 3 Adjustable Gallon
Supplementary Containers	No/Can Caddy Bin Utility Compartment
Lighting	LED
Freezer Compartment	
Door Type	Swing
Shelves	3 Adjustable Full-Width Glass or 3 Fixed Full-Width Wire
Freezer Number of Shelves	3
Freezer Drawer/Basket	1 Full-Width Lower Plastic
Door Bins	3 Fixed Full-Width
Light	LED
Dispenser	
Dispenser Type	Exterior Ice and Water
Dispenser Options	Filtered Water Ice Dispenser Lock Measured/Metered Fill Night Light
Types of Ice	Crushed/Cubed
Icemaker	
Icemaker	Factory Installed
Icemaker Location	Freezer
Electrical	
Hz	60

## Product Features

### CONTROL PANEL

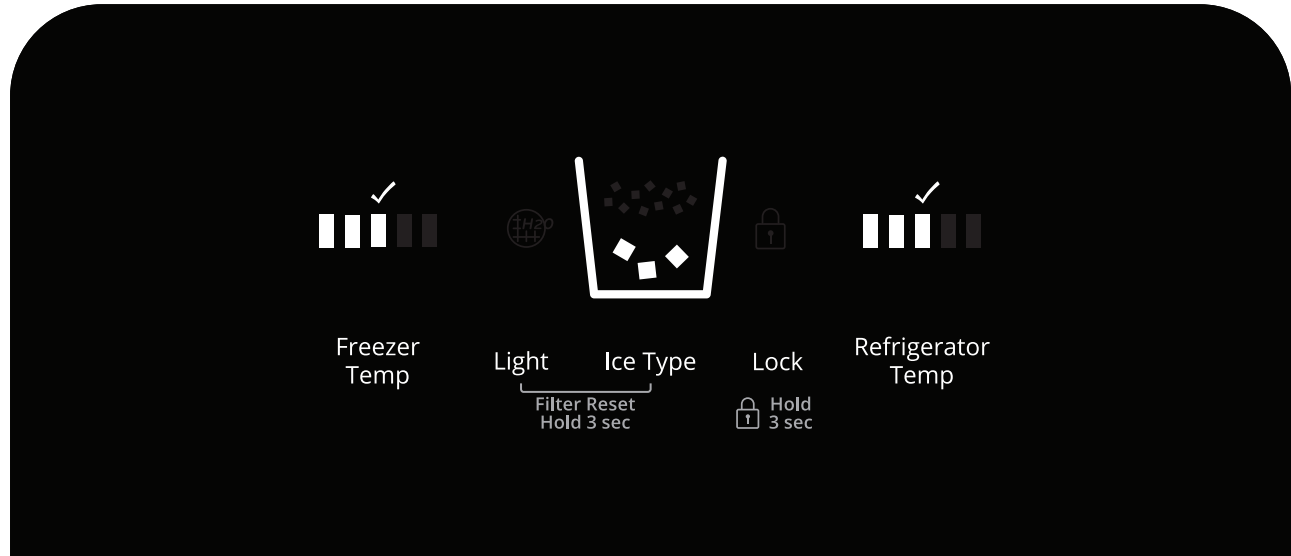

### Refrigerator Control:

- Press Refrigerator Temp to view the current set point for the refrigerator.
- Press Refrigerator Temp again to adjust the set point. The setting will increase by 1 bar with each press of the button, returning to 1 bar after reaching 5 bar.  
After 2 minutes of inactivity, any changes will be saved and the display will return to the home screen.

### Freezer Control:

- Press Freezer Temp to view the current set point for the freezer.
- Press Freezer Temp again to adjust the set point. The setting will increase by 1 bar with each press of the button, returning to 1 bar after reaching 5 bar.  
After 2 minutes of inactivity, any changes will be saved and the display will return to the home screen.

## Model & Serial Number Location



## Tech Sheet Location

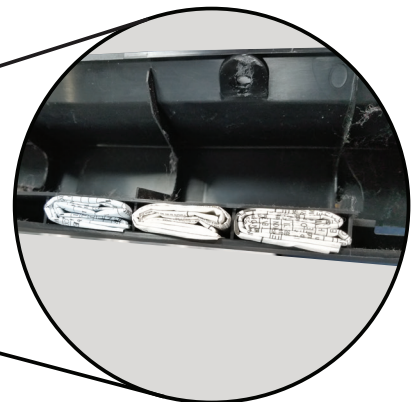

# Model Nomenclature

MODEL NUMBER	W	R	S	3	1	5	S	N	H	B
INTERNATIONAL SALES OR MARKETING CHANNEL										
Brand W = Whirlpool										
Platform R = Freestanding Refrigeration S = Specialty Refrigeration U = Undercounter Refrigeration Z = Freestanding Freezer										
Sub Platform/Fuel T = Top Freezer S = Side by Side B = Bottom Freezer F = French Door X = FD Double Drawer X = All Freezer V = Vertical Pantry										
Series 1 = OPP 3 = Low Line 5 = Mid Line 7 = High (GOLD) 9 = Hero (GOLD)										
Feature Level/Key Feature Feature Level (0-9) OR Derivative (Top Mount)										
Feature Level/Key Feature 0 = 10 OR 20 OR 30 Cu Ft 1 = 11 OR 21 Cu Ft 2 = 12 OR 22 Cu Ft 3 = 13 OR 23 Cu Ft 4 = 14 OR 24 Cu Ft 5 = 15 OR 25 Cu Ft 6 = 16 OR 26 Cu Ft 7 = 17 OR 27 Cu Ft										
C = Counter Depth F = Flat S = Smooth Contour T = Textured X = Light Texture, Contour O = Overlay K = Trim Kit B = Beveled Edge										
I = In-Door-Ice N = Non-Dispense W = Internal Water D = Dispense Ice & Water S = Shaved Ice C = Crushed Ice F = Field Install Ice Maker, No Water										
YEAR PF MARKET INTRODUCTION F = 2016 G = 2017 H = 2018 J = 2019										
COLOR W = White T = Bisque/Biscuit B = Black S = Black On Stainless										

# Notes

## Section 2: Diagnostics

This section provides diagnostic mode and sales mode information for the “Whirlpool®, Maytag®, Amana®, and IKEA® Refrigerators.”

- Safety
- Diagnostics Mode
- Sales Mode

# For Service Technician Use Only

## Safety

<b>⚠ DANGER</b>

<p style="text-align: center;"><b>Electrical Shock Hazard</b></p> <p>Only authorized technicians should perform diagnostic voltage measurements.</p> <p>After performing voltage measurements, disconnect power before servicing.</p> <p>Failure to follow these instructions can result in death or electrical shock.</p>

<b>⚠ WARNING</b>

<p style="text-align: center;"><b>Electrical Shock Hazard</b></p> <p>Disconnect power before servicing.</p> <p>Replace all parts and panels before operating.</p> <p>Failure to do so can result in death or electrical shock.</p>

<h3>Voltage Measurement Safety Information</h3> <p>When performing live voltage measurements, you must do the following:</p> <ul style="list-style-type: none"><li>■ Verify the controls are in the off position so that the appliance does not start when energized.</li><li>■ Allow enough space to perform the voltage measurements without obstructions.</li><li>■ Keep other people a safe distance away from the appliance to prevent potential injury.</li><li>■ Always use the proper testing equipment.</li><li>■ After voltage measurements, always disconnect power before servicing.</li></ul>
--

<p><b>IMPORTANT: Electrostatic Discharge (ESD) Sensitive Electronics</b></p> <p>ESD problems are present everywhere. ESD may damage or weaken the electronic control assembly. The new control assembly may appear to work well after repair is finished, but failure may occur at a later date due to ESD stress.</p> <ul style="list-style-type: none"><li>■ Use an antistatic wrist strap. Connect wrist strap to green ground connection point or unpainted metal in the appliance</li></ul> <p style="text-align: center;">-OR-</p> <p style="text-align: center;">Touch your finger repeatedly to a green ground connection point or unpainted metal in the appliance.</p> <ul style="list-style-type: none"><li>■ Before removing the part from its package, touch the antistatic bag to a green ground connection point or unpainted metal in the appliance.</li><li>■ Avoid touching electronic parts or terminal contacts; handle electronic control assembly by edges only.</li><li>■ When repackaging failed electronic control assembly in antistatic bag, observe above instructions.</li></ul>
---



## For Service Technician Use Only

### Diagnostics Mode

#### Service Information

1. Compressor suction and process stubs may not be interchanged.
2. Refrigerant charge must be applied to high side only.
3. Ice maker and water valve not original equipment on all models.
4. **NOTE:** Ice maker cycle must be initiated electrically. Do not try to manually start the cycle.
5. Part number can be found on the component.

\*Normal operating conditions are viewed when the air and temperature controls are at the mid-sitting freezer section 0 to -5°F and unit is cycling.

**NOTE:** Watt and pressure readings will vary and are influenced by the existing condition of the appliance such as the iced-up evaporator, condition of the condenser, defrost cycle, pull-down time and customer use.

Serviceable Electrical Parts Matrix (Components By Cu Ft Size)					
Serviceable Parts	21 Cu Ft	22 Cu Ft	25 Cu Ft	Wattage	Resistance (Ω)
	115 - 127 VAC				
Compressor	EGX60HLC			102	
	W11045354				
Run Windings	*				1 - 5
Start Device, Overload	See Note				
Run Capacitor (If Equipped)	See Note				
Electric Air Baffle Assembly	See Note			12 V DC	
Thermistor	See Note				2.7 kΩ at 25°C
User Interface Control	See Note				
Main Control	See Note				
Defrost Heater	See Note			550 - 650	
Evaporator Fan Motor	See Note			2 - 9	
Condenser Fan Motor	See Note			3 - 12	

Serviceable Electrical Parts Matrix					
Serviceable Parts	EGX60HLC	WATTAGE 115 - 127 VAC	EM3Y60HLP	WATTAGE 115 - 127 VAC	Resistance (Ω)
Compressor	W11045354	102	W11181053	109	
Run Windings	-		-		1 - 5
Start Device, Overload	See Note		See Note		
Run Capacitor (If Equipped)	See Note		See Note		
Electric Air Baffle Assembly	See Note	12 V DC	See Note	12 V DC	
Thermistor	See Note		See Note		2.7 kΩ at 25°C
User Interface Control	See Note		See Note		
Main Control	See Note		See Note		
Defrost Heater	See Note	550 - 650	See Note	550 - 650	
Evaporator Fan Motor	See Note	2 - 9	See Note	2 - 9	
Condenser Fan Motor	See Note	3 - 12	See Note	3 - 12	

## For Service Technician Use Only

Performance Data * (Normal Operating Conditions)			
AMB	Watts	System Pressure (PSIG)	
		High Side	Low Side
EG Series			
70°	140 +/- 20	95 +/- 20	- 7 To 3
90°	150 +/- 20	135 +/- 20	- 4 To 3
110°	170 +/- 20	185 +/- 20	- 2 To 4
EM3 Series			
70°	120 +/- 20	120 +/- 20	- 6 To 3
90°	130 +/- 20	160 +/- 20	- 4 To 3
110°	140 +/- 20	220 +/- 20	- 2 To 4

### Compressor Options - Refer To Applicable Design (Oil cooler not present on all compressors)

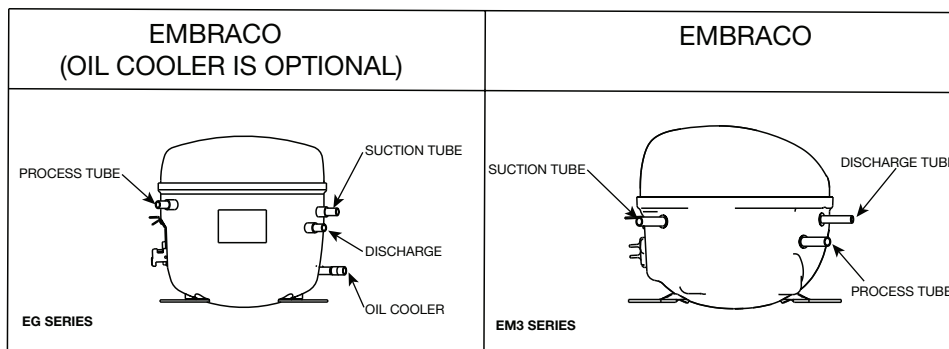

### Service Key Assignment

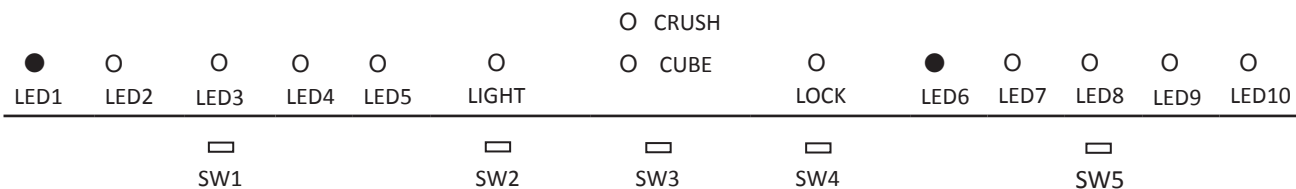

During the first five minutes after a power on, put setting temperature at the minimum position for both RC and FC.

Afterward, hold "FREEZER TEMP" and "ICE TYPE" keys for 3 seconds to enter service mode.

After entering service mode, all LEDs will turn on to verify all LEDs can turn on.

To proceed to service steps, a user shall press all 5 keys individually from left to right to turn off all LEDs and validate touch function.

**NOTE:** For smooth operation of user interface key activation, wait at least 1 second between each press, to let the system toggle between service steps.

KEYS	DESCRIPTION
SW2 = Light Key	Increment Key: Advance to next step
SW4 = Lock Key	Decrement Key: Go back to the previous step
SW5 = RC Temp Key	Change Setting Key: Turn ON/OFF load, PAUSE/RUN specific test

**NOTE:** For IDI model with twist tray ice maker, upon entry into service, an ice maker is enabled and a homing operation is performed, this is to avoid of any other load interference when SANKYO IM is performing the Homing operation.

The LEDs on the FREEZER TEMP section will show the step number while the LEDs above REFRIGERATION TEMP section will show the feedback. Steps 29 to 35 apply only for models with twist tray maker in the door (IDI).

## For Service Technician Use Only

Step	Step Code	Component	Action	Feedback
1	<p>● ○ ○ ○ ○ LED1 LED2 LED3 LED4 LED5</p>	FC Sensor	<p>Entry: Display step number &amp; start sensor check.</p> <p>Do: Read the current temperature of the FC thermistor and compare the value.</p> <p>Exit: Stop sensor readings.</p>	<p>Open sensor display: ● ○ ○ ○ ○ LED6 LED7 LED8 LED9 LED10</p> <p>Short sensor display: ○ ○ ● ○ ○ LED6 LED7 LED8 LED9 LED10</p> <p>Pass test display: ○ ● ● ● ○ LED6 LED7 LED8 LED9 LED10</p> <p>Sensor status blank until gets a valid reading ○ ○ ○ ○ ○ LED6 LED7 LED8 LED9 LED10</p>
2	OFF	NONE	OFF	OFF
3	<p>● ● ○ ○ ○ LED1 LED2 LED3 LED4 LED5</p>	RC Sensor Step Code:	<p>Entry: Display step number &amp; start sensor check.</p> <p>Do: Read the current temperature of the RC thermistor and compare the value.</p> <p>Exit: Stop sensor readings.</p>	<p>Open sensor display: ● ○ ○ ○ ○ LED6 LED7 LED8 LED9 LED10</p> <p>Short sensor display: ○ ○ ● ○ ○ LED6 LED7 LED8 LED9 LED10</p> <p>Pass test display: ○ ● ● ● ○ LED6 LED7 LED8 LED9 LED10</p> <p>Sensor status blank until gets a valid reading ○ ○ ○ ○ ○ LED6 LED7 LED8 LED9 LED10</p>
4	OFF	NONE	OFF	OFF
5	<p>● ● ● ○ ○ LED1 LED2 LED3 LED4 LED5</p>	Defrost Sensor	<p>Entry: Display step number &amp; start sensor check.</p> <p>Do: Read the current temperature of the Defrost thermistor and compare the value.</p> <p>Exit: Stop sensor readings.</p>	<p>Open sensor display: ● ○ ○ ○ ○ LED6 LED7 LED8 LED9 LED10</p> <p>Short sensor display: ○ ○ ● ○ ○ LED6 LED7 LED8 LED9 LED10</p> <p>Pass test display: ○ ● ● ● ○ LED6 LED7 LED8 LED9 LED10</p> <p>Sensor status blank until gets a valid reading ○ ○ ○ ○ ○ LED6 LED7 LED8 LED9 LED10</p>
6	OFF	NONE	OFF	OFF
7	<p>● ● ● ● ○ LED1 LED2 LED3 LED4 LED5</p>	Compressor & Cond Fan	<p>Entry: Display step number &amp; turn ON the Cond fan.</p> <p>Do: Service user to monitor load.</p> <p>Exit: Load off.</p>	N/A
8	OFF	NONE	OFF	OFF

**For Service Technician Use Only**

Step	Step Code	Component	Action	Feedback
9	○   ○   ○   ○   ● LED1 LED2 LED3 LED4 LED5	Damper Open	Entry: Display step number & open damper. Do: Service user to monitor the damper position. Exit: Damper close.	N/A
10	OFF	Damper close	OFF	OFF
11	○   ○   ○   ●   ● LED1 LED2 LED3 LED4 LED5	Damper heater ON	Entry: Display step number & turn on damper heater. Do: Service user to monitor the damper heater. Exit: Load off.	N/A
12	OFF	NONE	OFF	OFF
13	○   ○   ●   ●   ● LED1 LED2 LED3 LED4 LED5	Defrost Heater ON	Entry: Display step number & turn on the heater. Do: Service user to monitor the load. Exit: Load off.	N/A
14	OFF	NONE	OFF	OFF
15	○   ●   ●   ●   ● LED1 LED2 LED3 LED4 LED5	Evaporator Fan ON	Entry: Display step number & turn on the EVAP fan. Do: Service user to monitor the load. Exit: Load off.	N/A
16	OFF	NONE	OFF	OFF
17	●   ○   ○   ○   ● LED1 LED2 LED3 LED4 LED5	Dispenser light ON	Entry: Display step number & turn on the dispenser lights. Do: Service user to monitor the load. Exit: Load off.	N/A
18	OFF	NONE	OFF	OFF
19	●   ○   ○   ●   ● LED1 LED2 LED3 LED4 LED5	Water Dispenser Valve	Entry: Display step number. Do: Press the water paddle to activate valve and monitor load. Exit: Load off.	<b>NOTE:</b> Water valve will remain on after paddle release, to exit press key SW2 (Light).
20	OFF	NONE	OFF	OFF
21	●   ○   ●   ●   ● LED1 LED2 LED3 LED4 LED5	RC door switch input	Entry: Display step number. Do: Lights will have to be verified on the product. Exit: N/A.	Door Open: Internal RC lights ON. Door Closed: Internal RC lights OFF.
22	OFF	NONE	OFF	OFF
23	●   ●   ○   ●   ● LED1 LED2 LED3 LED4 LED5	FC door switch input	Entry: Display step number. Do: Lights will have to be verified on the product. Exit: N/A.	Door Open: Internal FC lights ON. Door Closed: Internal FC lights OFF.
24	OFF	NONE	OFF	OFF
25	●   ●   ●   ○   ● LED1 LED2 LED3 LED4 LED5	Ice Paddle	Entry: Display step number. Do: User to press ice paddle. Service user to monitor the display feedback. Exit: N/A.	Paddle Pressed: ●   ○   ○   ○   ○ LED6 LED7 LED8 LED9 LED10 <b>NOTE:</b> No water is dispensed in this step.
26	OFF	NONE	OFF	OFF

## For Service Technician Use Only

Step	Step Code	Component	Action	Feedback
27	● ○ ○ ● ○ LED1 LED2 LED3 LED4 LED5	Water Paddle	Entry: Display step number. Do: User to press water paddle. Service user to monitor the display feedback. Exit: N/A.	Paddle Pressed: ● ○ ○ ○ ○ LED6 LED7 LED8 LED9 LED10 <b>NOTE:</b> No water is dispensed in this step.
28	OFF	NONE	OFF	OFF
29	● ○ ● ○ ○ LED1 LED2 LED3 LED4 LED5	Ice harvest		RC Feedback information <b>1.</b> Blank = Until get a valid reading ○ ○ ○ ○ ○ LED6 LED7 LED8 LED9 LED10 <b>2.</b> IM harvest cycle is ON ● ○ ○ ○ ○ LED6 LED7 LED8 LED9 LED10 <b>3.</b> IM harvest cycle is OFF ● ● ○ ○ ○ LED6 LED7 LED8 LED9 LED10 <b>4.</b> Ice bucket full detected ● ● ● ○ ○ LED6 LED7 LED8 LED9 LED10 <b>5.</b> Ice bucket not full ● ● ● ● ○ LED6 LED7 LED8 LED9 LED10 <b>6.</b> Switch faulty or motor (Timeout = 20 seconds) ● ● ● ● ● LED6 LED7 LED8 LED9 LED10
30	OFF	NONE	OFF	OFF
31	● ● ○ ● ○ LED1 LED2 LED3 LED4 LED5	Ice maker water fill test	Entry: Display step number. Upon entry to this step, there will be a 3 seconds delay, and then the ice tray will be moved to the home position. Do: After the tray has reached home position, the "CHANGE SETTING KEY" will start an ice maker fill (only 100 ml +/- 10). Service user to monitor the display feedback. Exit: Clear feedback information.  <b>NOTE:</b> At step entry the water fill cycle default to OFF. Prior entry of this run step 29, make sure the ice tray is empty. Before proceeding with water fill, otherwise, double fill will occur. Make sure to proceed with step 29 after water fill test to leave tray empty when finishing service. Ice bucket must be in place to run this test.	RC Feedback information <b>1.</b> Configuration to start ○ ○ ○ ○ ○ LED6 LED7 LED8 LED9 LED10 <b>2.</b> Ice tray moving to the home position ● ○ ○ ○ ○ LED6 LED7 LED8 LED9 LED10 <b>3.</b> Water fill OFF ● ● ○ ○ ○ LED6 LED7 LED8 LED9 LED10 <b>4.</b> Water fill ON ● ● ● ○ ○ LED6 LED7 LED8 LED9 LED10
32	OFF	NONE	OFF	OFF

## For Service Technician Use Only

Step	Step Code	Component	Action	Feedback
33	●    ○    ●    ○    ● LED1 LED2 LED3 LED4 LED5	SANKYO Ice maker - Ice tray thermistor	Entry: Display step number. Do: Read the current temperature of the ice maker tray, thermistor and compare this value. This information shall be dynamically updated every second. Service user to monitor the display feedback. Exit: Clear feedback information.  <b>NOTE:</b> For models without twist tray ice maker, the feedback will read as open.	Open sensor display ●    ○    ○    ○    ○ LED6 LED7 LED8 LED9 LED10 Short sensor display ○    ○    ●    ○    ○ LED6 LED7 LED8 LED9 LED10 Pass test display ○    ●    ●    ●    ○ LED6 LED7 LED8 LED9 LED10 Sensor status blank until gets a valid reading ○    ○    ○    ○    ○ LED6 LED7 LED8 LED9 LED10
34	OFF	NONE	OFF	OFF
35	●    ●    ●    ●    ● LED1 LED2 LED3 LED4 LED5	Service completed	Last step in service	N/A

### Service Mode Steps For Athena Control

During the first 30 seconds after power up the product, press TEMP setting button, until is located min position, then hold the refrigerator door switch to simulate the door is closed, and at the same time hold press refrigerator TEMP button for 5 seconds until the board enters service mode.

#### System Action

Into service state mode, all temperature LEDs turn on for and turn OFF after 10 seconds.

A user must use the SW1 button to advance steps into service mode. User shall wait 3 seconds between each keypress to allow the system stabilization.

All sensors will be tested without required action from service personnel. This action is taken after the heater off.

After last step press SW1 to exit service mode, user interface will reset to the last mode and start the power-up state.

Switch Press	Display Information				Load
	D 9	D 8	D 7	D 6	
0	□	□	□	□	Start condition
1	□	□	■	□	Compressor On
2	□	□	□	□	Compressor Off
3	□	■	□	□	Heater On
4	□	□	□	□	Heater Off
5	■	□	□	□	Not Used
6	□	□	□	□	Display Fail Message
7	□	■	□	□	Return To Normal OP (Default To Med)

The fail information is shown below with the LEDs turned ON, this will appear in step 6 from the above table.

**NOTE:** If step 6 shows all LEDs blank means that board drivers and sensors are working correctly.

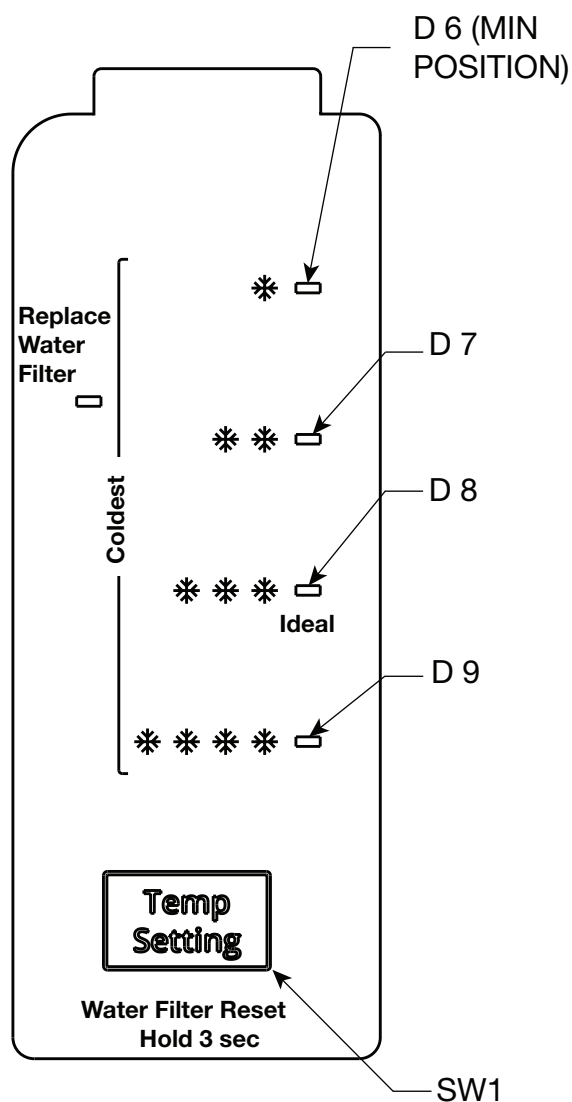

## For Service Technician Use Only

### Display Fail Message State Table

Display Information				LEDs ON (No Blinking) when Illuminated
D 9	D 8	D 7	D 6	
□	□	■	□	Main Board (Heater driver or compressor driver)
□	■	□	□	Refrigerator Sensor
■	□	□	□	Defrost Sensor
■	■	□	□	Refrigerator & Defrost Sensor
□	■	■	□	Main Board + Refrigerator Sensor
■	□	■	□	Main Board + Defrost Sensor
■	■	■	□	Multiple Failures (Sensors + Drivers)

#### For Display Model Only:

For water filter indicator reset LED test, press and hold TEMP button for 3 seconds until the water filter LED blinks to verify LED function.

For dispenser function, use the wiring diagram for reference to validate all connections and switch operation.

## Sales Demo Mode

### CUDA 17 IDI & DPLUS

#### Water Filter Reset & Showroom Mode

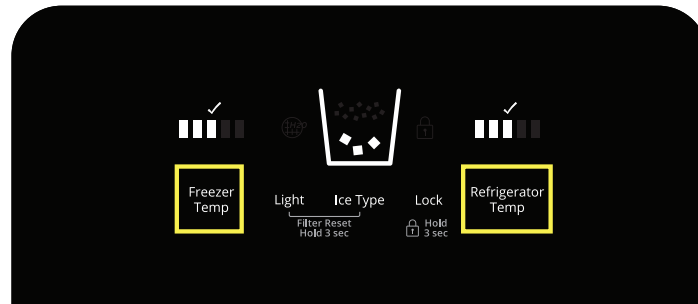

SHOWROOM Mode Use Case	System Feedback	Reference
To enter showroom mode 1. Within 2 minutes after power-up, press and hold (RC & FC TEMP keys) for 5 seconds.	The system enters in Showroom mode. UI performs "showroom animation": <ul style="list-style-type: none"> <li>All five LEDs (RC &amp; FC TEMP LEDs) turn on one by one from left to right and then right to left and keep cycling. (Cycling rate: 1 cycle per second).</li> <li>Showroom mode does not activate sleep mode.</li> <li>If there is no user action during 2 minutes of showroom mode, the animation will stop and then UI behaves (fake) as normal mode.</li> <li>During the animation, if the user touches any key, the animation will stop and UI behaves as a fake normal mode.</li> <li>During fake normal mode, after two minutes without user interaction, the animation will start again to indicate that UI is in showroom mode.</li> </ul>	Fake normal mode is normal mode with all cooling loads off.
Press (FC TEMP SETTING or RC TEMP SETTING) key in the showroom mode.	The recommended temperature setting (i.e. <colder>) is on. Then UI behaves (fake) as normal mode if the user presses any key again, except that cooling stays off in showroom mode and no temperature setting is saved.	
Press (LIGHT) Key in show room	Behavior will be same as normal operation.	
Press (ICE TYPE) key in show room mode.	Ice-type LED changes between crush when the user presses the Ice Type key.	

## For Service Technician Use Only

CUDA 17 D lite & Non Disp

Water Filter Reset & Showroom Mode

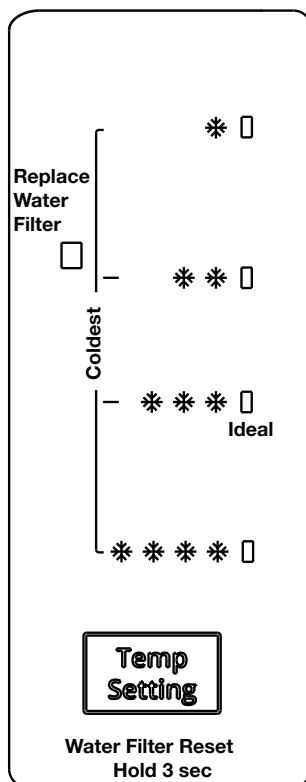

Showroom Mode Use Case	System Feedback
To enter showroom mode 1. Within 2 minutes after power-up, toggle (TEMP SETTING) button till <MAX> is on. 2. Hold DOOR SWITCH to simulate door close. 3. Press and hold (TEMP SETTING) for 3 seconds.	The system enters into Showroom mode. UI performs "showroom mode": <ul style="list-style-type: none"> <li>All four LEDs turns on one by one from top to bottom and then bottom to top and keep cycling. (Cycling rate: 1 cycle per second)</li> </ul>
Press (TEMP SETTING) button in showroom mode.	LEDs stop cycling. The recommended temperature setting (i.e. <colder>) is on. Then UI behaves (fake) as normal mode if user presses (TEMP SETTING) button again, except that cooling stays off in the showroom mode and no temperature setting is saved.
User inactivity for 3 seconds	UI returns to "showroom animation".
To exit showroom mode 1. Toggle (TEMP SETTING) button will <MAX> is on. 2. Hold DOOR SWITCH to simulate door close. 3. Press and hold (TEMP SETTING) for 3 seconds.	UI exits showroom mode and returns to normal mode with the default setting.
Power interval during showroom mode.	UI returns to Normal mode after a power reset or power failure.



---

# For Service Technician Use Only

## Notes

**For Service Technician Use Only**

**Notes**

## Section 3: Component Testing

This section provides the wiring diagram and component location for the “Whirlpool®, Maytag®, Amana®, and IKEA® Refrigerators.”

- Safety
- Wiring Diagram
- Component Location

For Service Technician Use Only

Safety

**⚠ DANGER**



**Electrical Shock Hazard**  
Only authorized technicians should perform diagnostic voltage measurements.  
After performing voltage measurements, disconnect power before servicing.  
Failure to follow these instructions can result in death or electrical shock.

**⚠ WARNING**



**Electrical Shock Hazard**  
Disconnect power before servicing.  
Replace all parts and panels before operating.  
Failure to do so can result in death or electrical shock.

**Voltage Measurement Safety Information**

When performing live voltage measurements, you must do the following:

- Verify the controls are in the off position so that the appliance does not start when energized.
- Allow enough space to perform the voltage measurements without obstructions.
- Keep other people a safe distance away from the appliance to prevent potential injury.
- Always use the proper testing equipment.
- After voltage measurements, always disconnect power before servicing.

**IMPORTANT: Electrostatic Discharge (ESD) Sensitive Electronics**

ESD problems are present everywhere. ESD may damage or weaken the electronic control assembly. The new control assembly may appear to work well after repair is finished, but failure may occur at a later date due to ESD stress.

- Use an antistatic wrist strap. Connect wrist strap to green ground connection point or unpainted metal in the appliance

-OR-

Touch your finger repeatedly to a green ground connection point or unpainted metal in the appliance.

- Before removing the part from its package, touch the antistatic bag to a green ground connection point or unpainted metal in the appliance.
- Avoid touching electronic parts or terminal contacts; handle electronic control assembly by edges only.
- When repackaging failed electronic control assembly in antistatic bag, observe above instructions.

**For Service Technician Use Only**

**Wiring Diagram**

**Wiring diagram A for models:**

WRS321SDHB, WRS321SDHB01, WRS321SDHB02, WRS321SDHV, WRS321SDHV01, WRS321SDHV02, WRS321SDHW, WRS321SDHW01, WRS321SDHW02, WRS321SDHZ, WRS321SDHZ01, WRS321SDHZ02, WRS325SDHB, WRS325SDHB01, WRS325SDHB02, WRS325SDHV, WRS325SDHV01, WRS325SDHV02, WRS325SDHW, WRS325SDHW01, WRS325SDHW02, WRS325SDHZ, WRS325SDHZ01, WRS321SDHB, WRS321SDHB00, WRS321SDHV, WRS321SDHV00, WRS321SDHW, WRS321SDHW00, WRS321SDHZ, WRS321SDHZ00, WRS325SDHB, WRS325SDHB00, WRS325SDHV, WRS325SDHV00, WRS325SDHW, WRS325SDHW00, WRS325SDHZ, WRS325SDHZ00.

VOLTAGE TEST POINTS THESEUS						
MAIN CONTROL (ACU)	CONNECTOR	FROM	COLOR	TO	COLOR	SPECIFICATIONS
	P1	P1-1	BK	P1-2	WH	120 VAC Input constant from Power Cord
		P1-2	WH	P1-4	RD	120 VAC Output to Compressor/Condenser Fan when cooling
	P2	P2-1	YL/RD	P1-1	BK	120 VAC Input FC Light switch feedback
		P2-4	YL	P1-1	BK	120 VAC Input FC Light switch feedback
		P2-6	RD/WH	P1-2	WH	120 VAC Output to Evaporator Fan when cooling
	P3	P2-7	BR	P1-2	WH	120 VAC Output Defrost Heater when defrosting
		P3-4	V	P1-2	WH	120 VAC Output to Water Valve when water dispensing
		P3-5	LB	P1-1	BK	120 VAC Input FC Door switch
		P3-6	GY/OR	P1-2	WH	120 VAC Output to Cube Solenoid when dispensing cube
	P4	P3-8	BU	P1-2	WH	120 VAC Output to Auger Motor when dispensing ice
		P4-1	OR	P4-4	LB	12.7 VDC Output to User Interface
	P5	P4-3 GY				DATA COMMUNICATION
		P5-1	GY	P5-2	GY	5 VDC Input RC Thermistor
	P8	P5-3	TN	P5-4	TN	5 VDC Input FC Thermistor
		P8-1	PK	P8-2	PK	5 VDC Input Defrost Thermistor
	P70	P8-7	V	P8-8	RD	12.7 VDC Output to Dispenser LED
		P70-7 BU				12 VDC Pulse Damper Stepper Motor coil A +
	P11	P70-8 BH				12 VDC Pulse Damper Stepper Motor coil A -
		P11-1 YL				12 VDC Pulse Damper Stepper Motor coil B +
P11-2 RD				12 VDC Pulse Damper Stepper Motor coil B -		
	P11-3	BR	P11-4	BR	12 VDC Output to damper Heater	
VOLTAGE TEST POINTS MINOTAUR						
HMI	J1	J1-1	LB	J1-4	OR	12.7 VDC Output to User Interface
		J1-2 GY				DATA COMMUNICATION

# For Service Technician Use Only

## Wiring diagram A

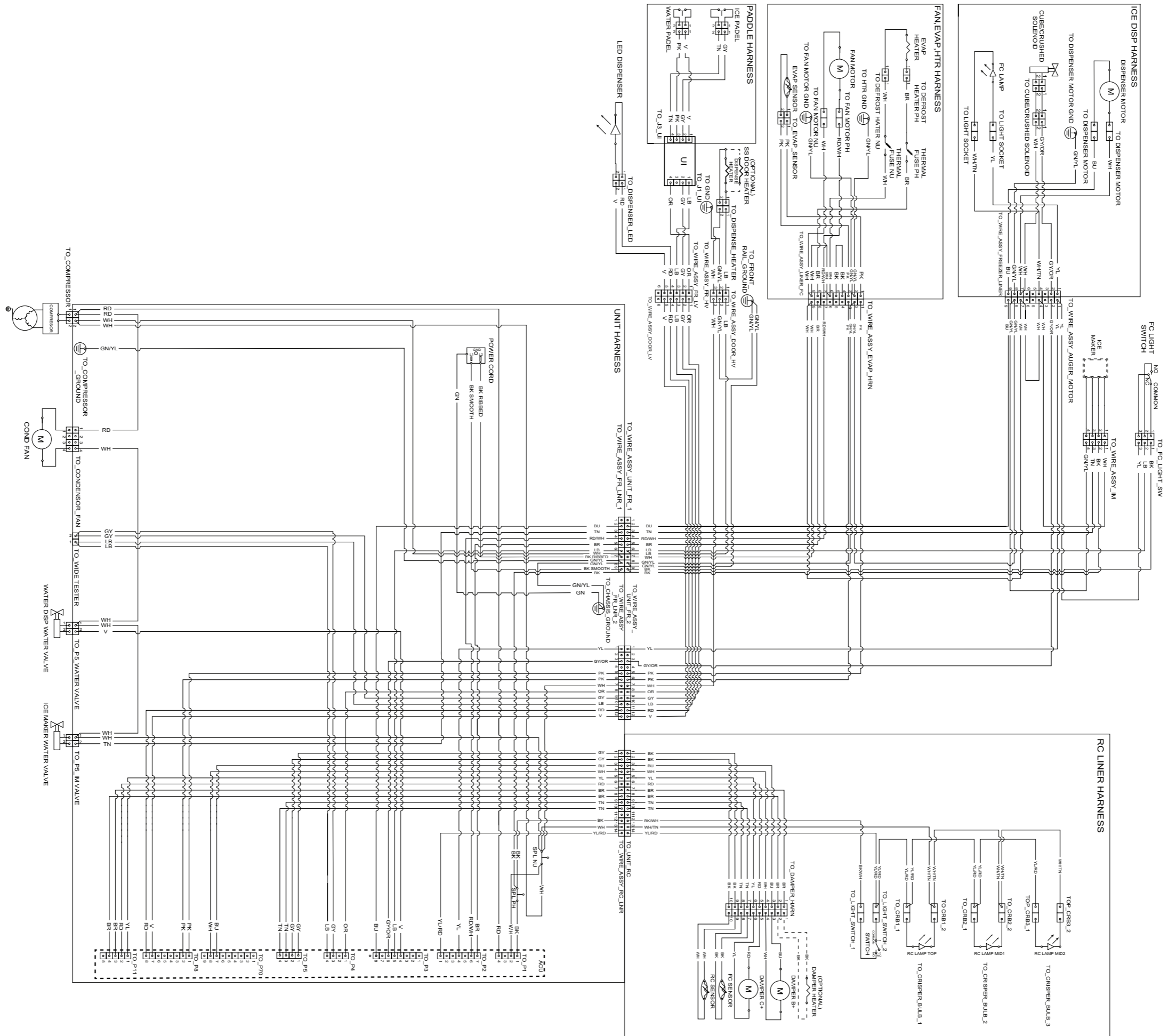

**For Service Technician Use Only**

**Wiring diagram B for models:**

ASI2575GRB, ASI2575GRB01, ASI2575GRS, ASI2575GRS01, ASI2575GRW, ASI2575GRW01, WRS315SDHB, WRS315SDHB01, WRS315SDHM, WRS315SDHM01, WRS315SDHT, WRS315SDHT01, WRS315SDHW, WRS315SDHW01, WRS311SDHB, WRS311SDHB00, WRS311SDHB01, WRS311SDHM, WRS311SDHM00, WRS311SDHM01, WRS311SDHM02, WRS311SDHT, WRS311SDHT00, WRS311SDHT01, WRS311SDHW, WRS311SDHW00, WRS311SDHW01, WRS311SDHZ, WRS311SDHZ00, WRS311SDHZ01, WRS315SDHB, WRS315SDHB00, WRS315SDHM, WRS315SDHM00, WRS315SDHM02, WRS315SDHT, WRS315SDHT00, WRS315SDHW, WRS315SDHW00, WRS315SDHZ, WRS315SDHZ00, WRS315SDHZ01.

VOLTAGE TEST POINTS ATHENA						
	CONNECTOR	FROM	COLOR	TO	COLOR	SPECIFICATIONS
MAIN CONTROL (ACU)	J2	J2-1	PK	J2-2	PK	5 VDC Input Evaporator Thermistor
		J2-3	GY	J2-4	GY	5 VDC Input Refrigerator Thermistor
	JP1	JP1-1	YL	JP1-3	BK	120 VAC input FC Light switch feedback when the door is open
		JP1-2	BR	JP1-6	WH	120 VAC Output Defrost Heater when defrosting
		JP1-3	BK	JP1-6	WH	120 VAC Input Constant from Power Cord
		JP1-4	RD	JP1-6	WH	120 VAC Output to Compressor and Fans when cooling

For Service Technician Use Only

Wiring diagram B

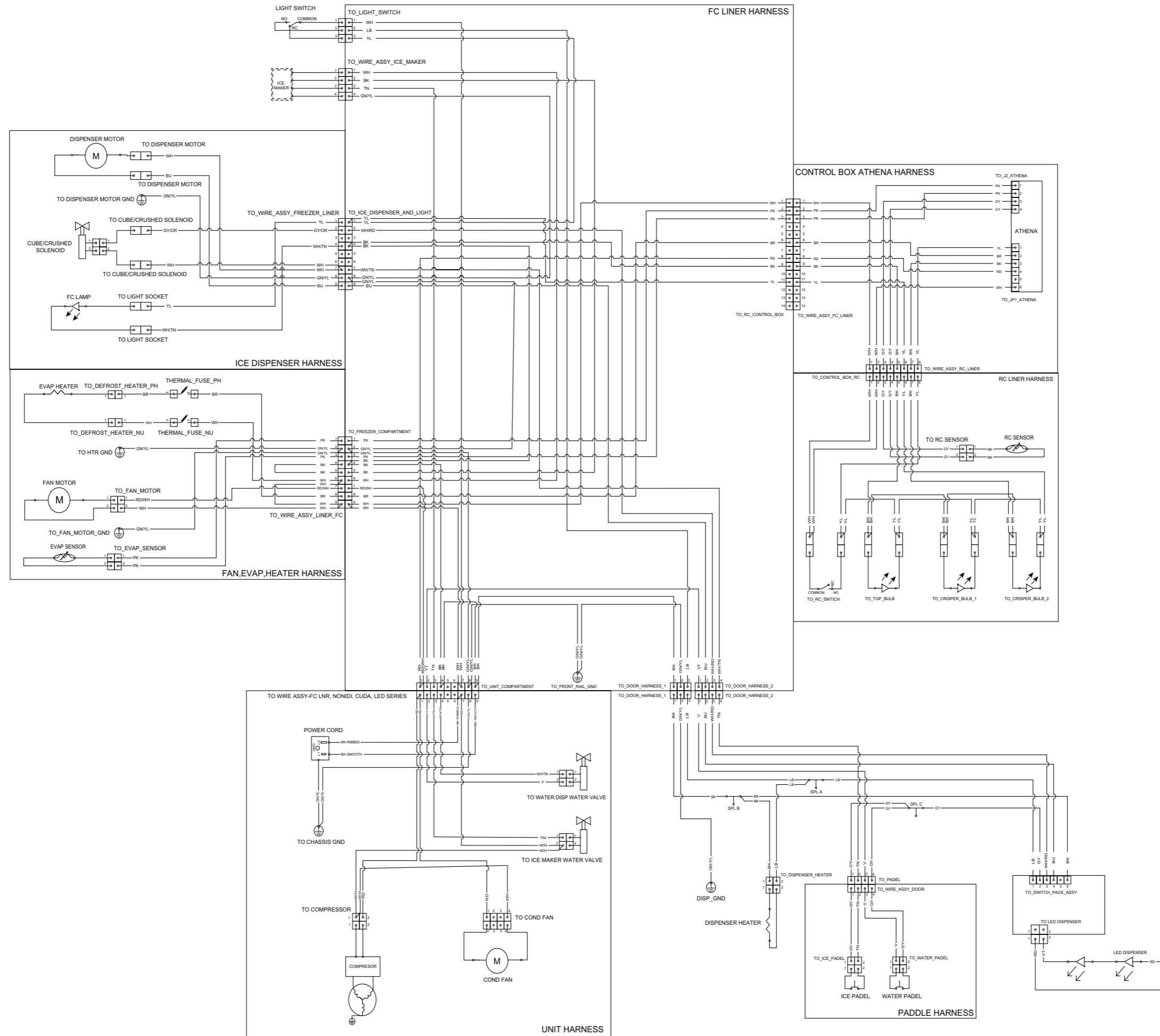



**For Service Technician Use Only**

**Wiring diagram C for models:**

WRS312SNHB01, WRS312SNHW01, WRS315SNHB, WRS315SNHB01, WRS315SNHM, WRS315SNHM01, WRS315SNHW, WRS315SNHW01, WRSA15SNHN, WRSA15SNHN01, WRSA15SNHZ, WRSA15SNHZ01, WRS312SNHB, WRS312SNHB00, WRS312SNHM, WRS312SNHM00, WRS312SNHM01, WRS312SNHW, WRS312SNHW00, WRS315SNHB, WRS315SNHB00, WRS315SNHM, WRS315SNHM00, WRS315SNHW, WRS315SNHW00, WRSA15SNHN, WRSA15SNHN00, WRSA15SNHZ, WRSA15SNHZ00.

VOLTAGE TEST POINTS ATHENA						
	CONNECTOR	FROM	COLOR	TO	COLOR	SPECIFICATIONS
MAIN CONTROL (ACU)	J2	J2-1	PK	J2-2	PK	5 VDC Input Evaporator Thermistor
		J2-3	GY	J2-4	GY	5 VDC Input Refrigerator Thermistor
	JP1	JP1-1	YL	JP1-3	BK	120 VAC Input FC Light switch feedback when the door is open
		JP1-2	BR	JP1-6	WH	120 VAC Output Defrost Heater when defrosting
		JP1-3	BK	JP1-6	WH	120 VAC Input constant from Power Cord
		JP1-4	RD	JP1-6	WH	120 VAC Output to Compressor and Fans when cooling

# For Service Technician Use Only

## Wiring diagram C

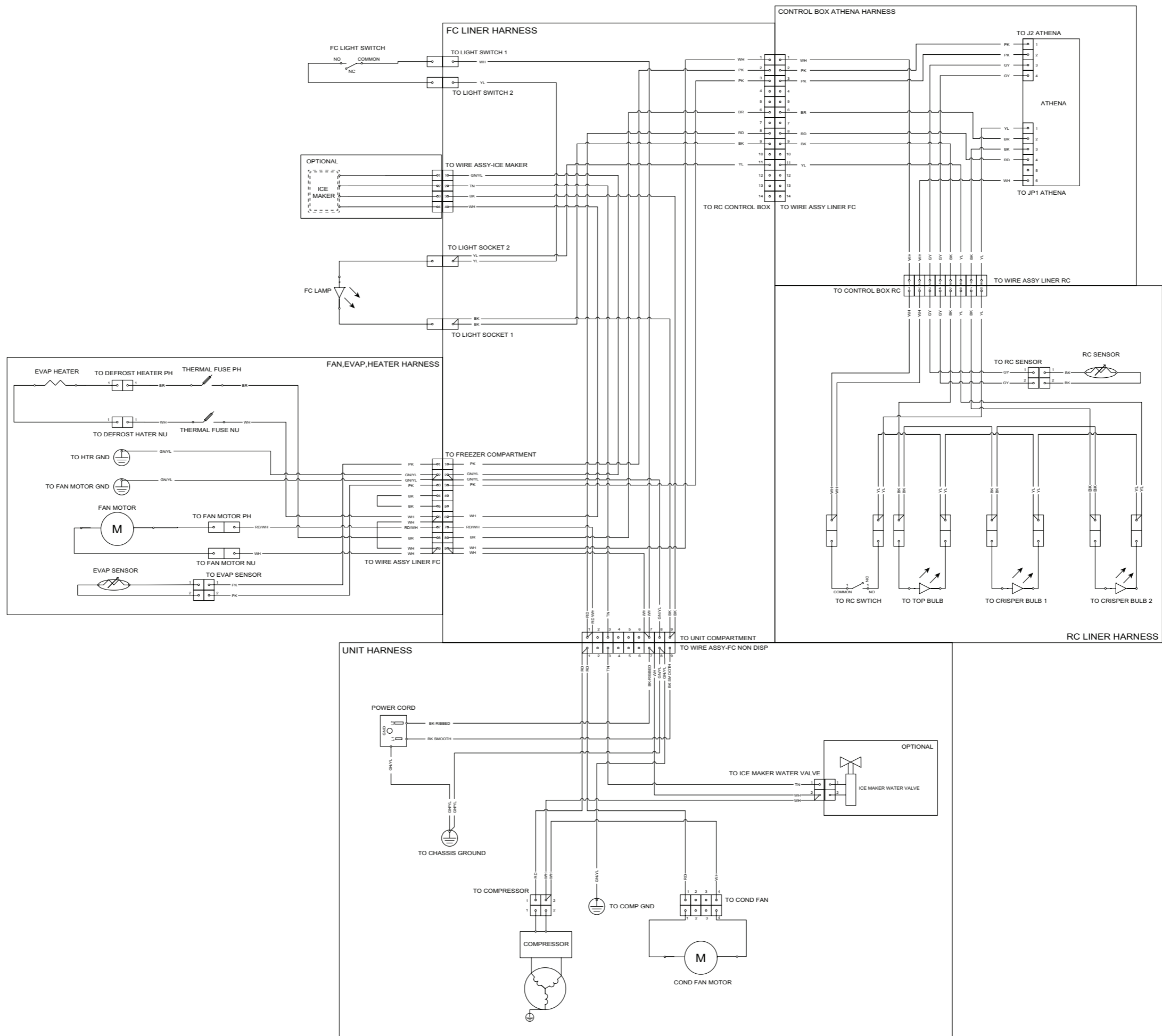

For Service Technician Use Only

Component Location

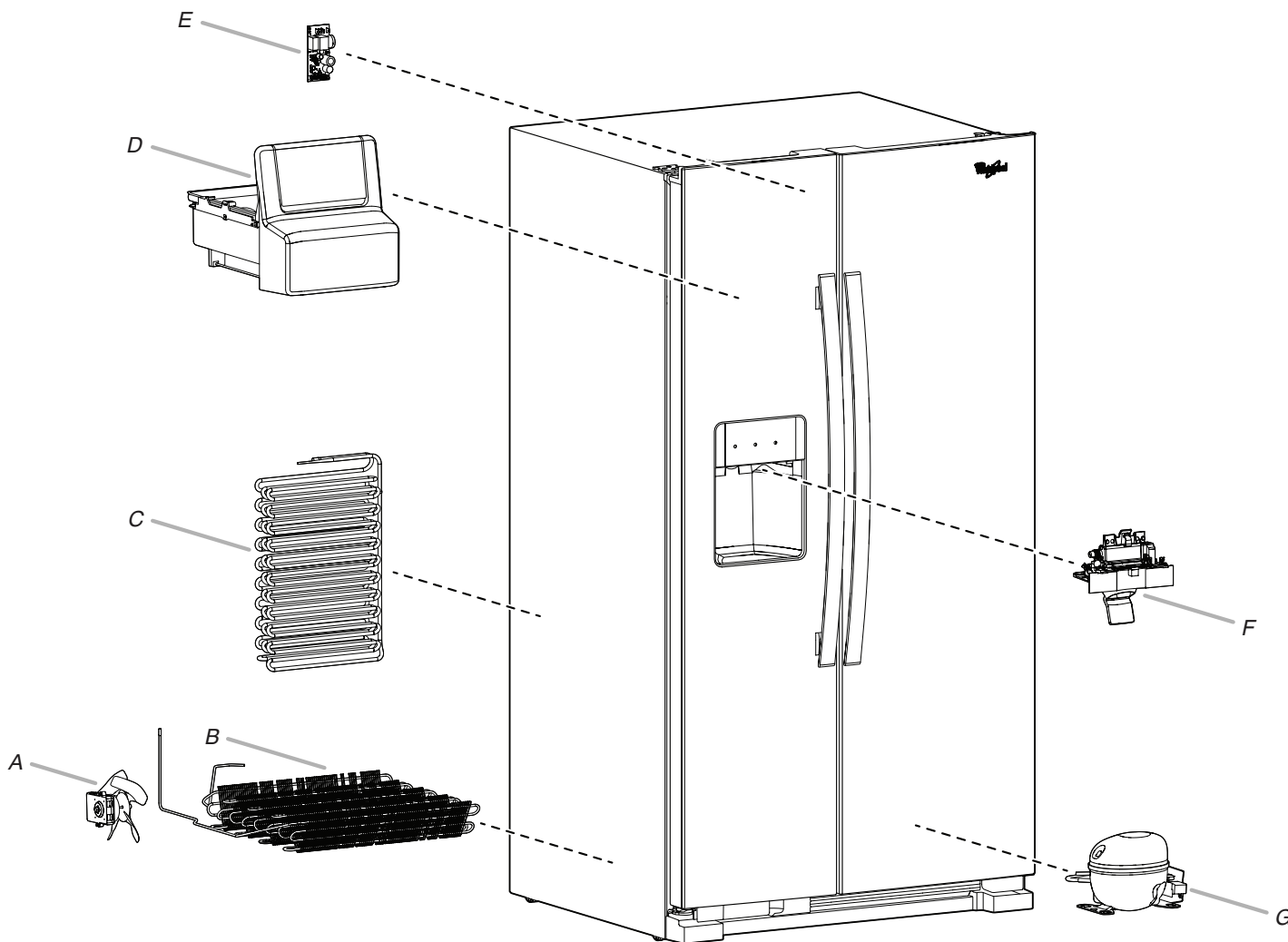

- A. Condenser Fan
- B. Condenser
- C. Freezer Evaporator
- D. Auger Ice Dispenser

- E. Athena Control Board
- F. Front Door Dispenser Unit
- G. Compressor

**For Service Technician Use Only**  
**Notes**

## Section 4: Component Access

This section provides service parts access, removal, and replacement instructions for the “Whirlpool®, Maytag®, Amana®, and IKEA® Refrigerators.”

- Removing the front wheel
- Accessing the interior of the unit
- Removing the damper
- Removing the freezer shelf
- Removing the dispenser
- Accessing the freezer evaporator and components
- Accessing the dispenser area (removing UI)
- Accessing the machine compartment

## Removing the Front Wheel

### **⚠ WARNING**



**Electrical Shock Hazard**  
Disconnect power before servicing.  
Replace all parts and panels before operating.  
Failure to do so can result in death or electrical shock.

1. Below picture shows level screw location.



2. Below picture shows level screw.  
A. Level screw

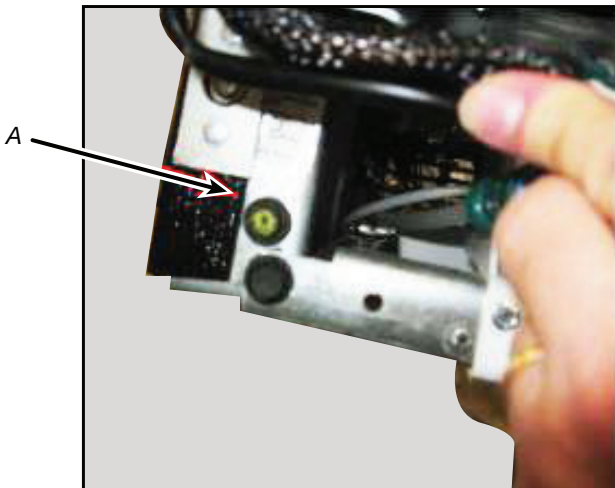

3. Below picture shows the clip and pin.  
A. Clip and pin

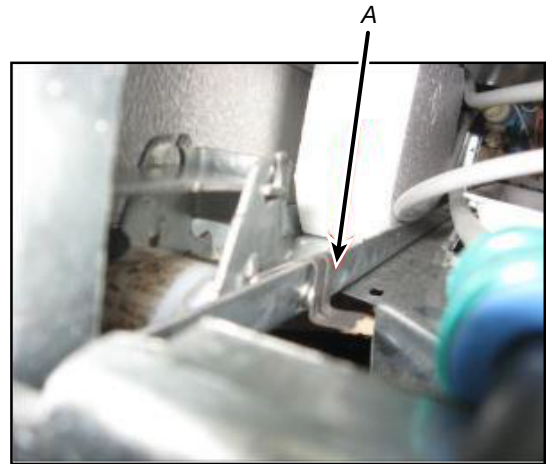

4. Remove the leveling screw and pry up the clip and remove. Then remove the pin at this point you can remove the wheel assembly.



5. Below picture shows the wheel out of the unit.



## Accessing Interior of Unit

## Removing the Damper

### ⚠ WARNING



**Electrical Shock Hazard**  
 Disconnect power before servicing.  
 Replace all parts and panels before operating.  
 Failure to do so can result in death or electrical shock.

### ⚠ WARNING



**Electrical Shock Hazard**  
 Disconnect power before servicing.  
 Replace all parts and panels before operating.  
 Failure to do so can result in death or electrical shock.

1. Below picture shows the interior of the unit.



2. There are some changes to the Cuda 17 compared to older Standard side by side refrigerator.
  - The return air was moved from the center of fresh food to lower left corner and it goes straight through.
  - The controls are all on the dispenser.

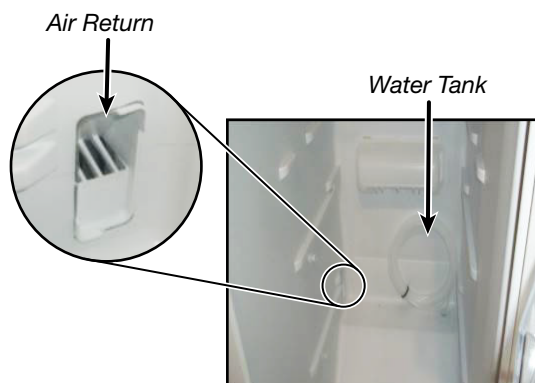

1. To remove damper completely first remove upper air duct in Freezer. You will have to remove IM and bin. Then remove the screw at the top of the air duct and it will come off.



2. Once freezer cover gets off then push on the tabs in the air supply area and this will push the damper out.

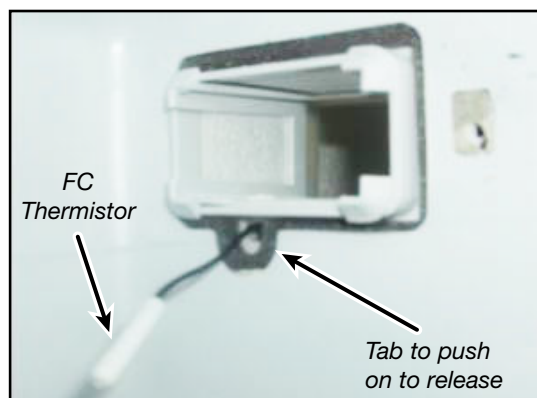

## COMPONENT ACCESS

3. Air damper is motor driven. To get to the damper first remove the screw in housing.

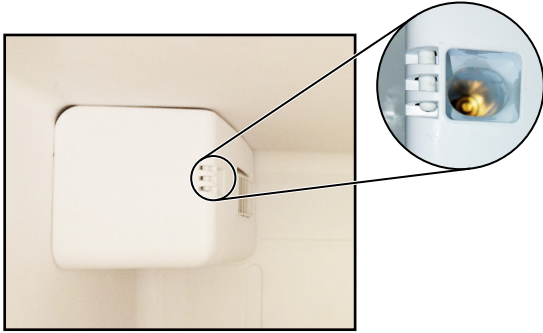

4. The cover will come off and then you can access the wiring harness.



5. The damper will come out. The damper has both RC and FC thermistor on the harness.



6. Below picture shows connections for fresh food door.

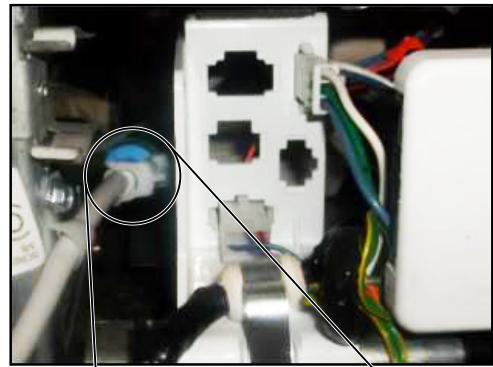



## Removing the Freezer Shelf

### ⚠ WARNING



#### Electrical Shock Hazard

Disconnect power before servicing.  
Replace all parts and panels before operating.  
Failure to do so can result in death or electrical shock.

1. Pick up the right side of the shelf and slide to the right as you would normally do. The bar will go into the deep pocket of the shelf holder.

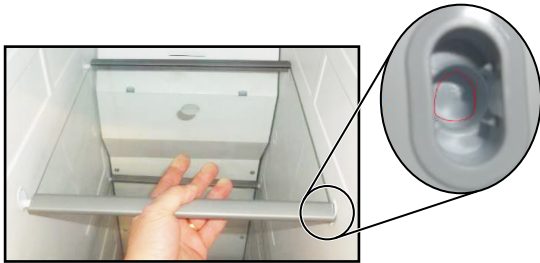

2. Now, take a needle nose pliers or you can try your fingers and grab the bar on the LEFT and push the bar over to the right until the end is exposed. Do this for both front and back.  
**Note:** At this point, the shelf can be dropped down and removed. To put the shelf back in just reverse the process.



## Accessing the Freezer Evaporator and Components

### ⚠ WARNING



#### Electrical Shock Hazard

Disconnect power before servicing.  
Replace all parts and panels before operating.  
Failure to do so can result in death or electrical shock.

1. After removing the shelves, remove the six 1/4" (6.4 mm) hex head screws, lift up on the panel and pull forward to remove.



## COMPONENT ACCESS

2. You will now have access to the Evaporator, Defrost heater, Defrost thermistor, Defrost drain pan, and Evaporator fan assembly.



3. Below picture shows freezer components. Defrost thermistor goes on the cap tube side.

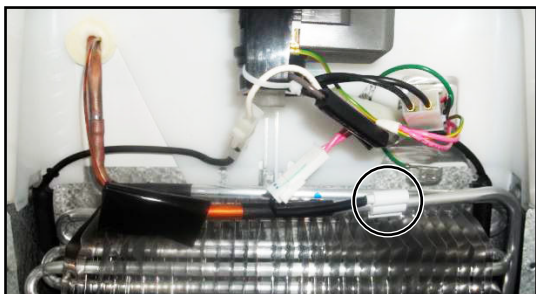

4. The unit does have heat probe in defrost drain. This transfers the heat from the defrost heater to the drain to prevent ice build up and causing drain restrictions.

A. Heat Probe

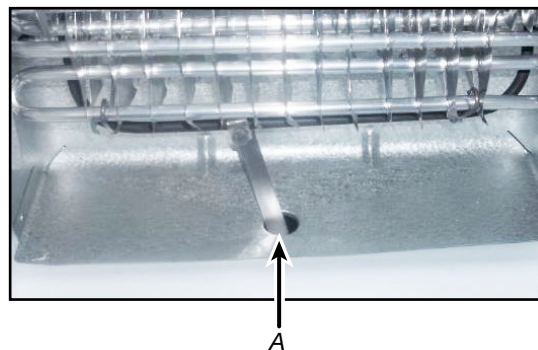

5. Below picture shows auger motor and cube/crushed coil.

A. Auger Solenoid

B. Auger Drive Motor

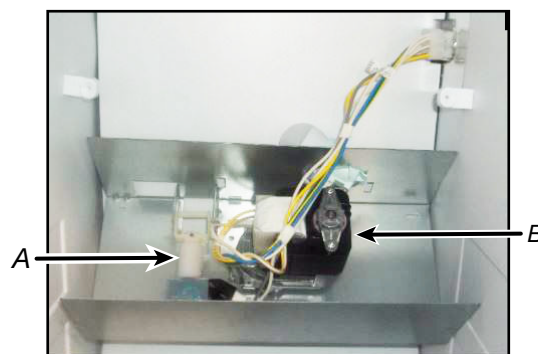

## Accessing the Dispenser Area (Removing UI)

### **⚠ WARNING**



**Electrical Shock Hazard**  
 Disconnect power before servicing.  
 Replace all parts and panels before operating.  
 Failure to do so can result in death or electrical shock.

1. Below picture shows the dispenser area.



2. Once sides are removed then use a screwdriver to push on all three tabs that are behind the UI to release it.



## COMPONENT ACCESS

3. Remove the left side covers by removing screws to access the dispenser.

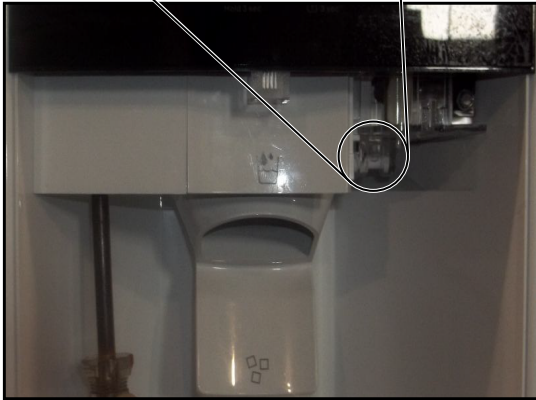

4. You now have access to the wiring for UI.



5. To remove the water line push the locking tab out. Do this from the bottom.

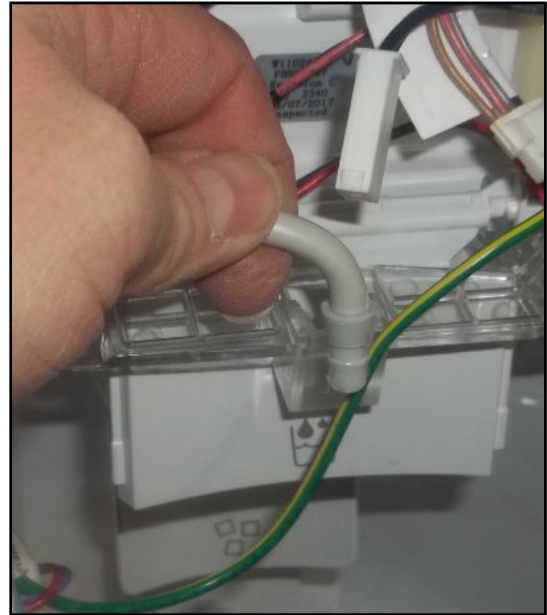

6. To remove ice door, remove water line for the holder. Remove the upper screws then pry tabs.

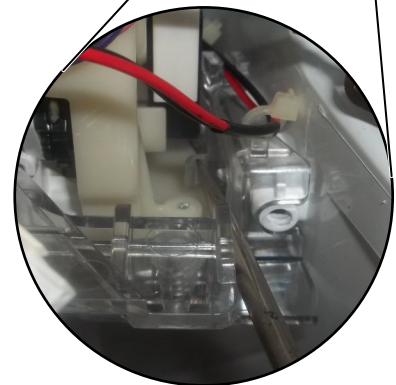
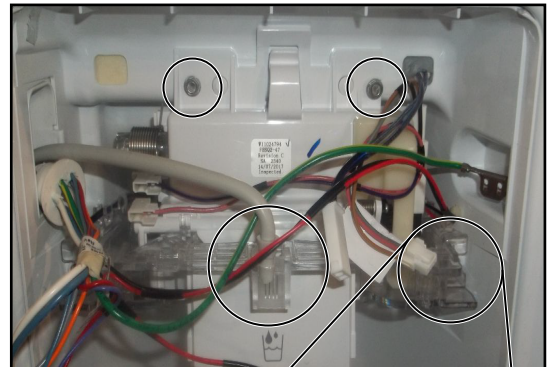



7. Below pictures show the ice chute assembly.

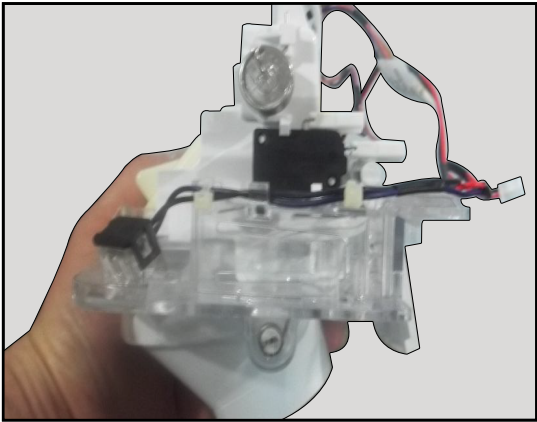

## Accessing the Machine Compartment

### **⚠ WARNING**



#### Electrical Shock Hazard

Disconnect power before servicing.  
 Replace all parts and panels before operating.  
 Failure to do so can result in death or electrical shock.

1. Below picture shows the machine compartment. Remove screws from the back panel.



2. You now have access to the following components:

- A. Compressor inverter
- B. Compressor
- C. Condenser Fan Motor
- D. Filter Dryer
- E. Dual water valve

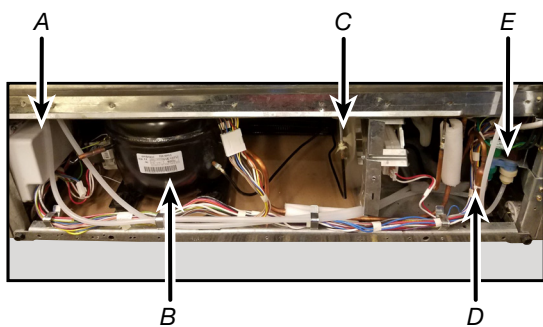

3. To remove the compressor inverter, remove the two 1/4" (6.4 mm) hex head screws. Disconnect the wiring then pull the inverter out.
  - A. Compressor inverter
  - B. Compressor

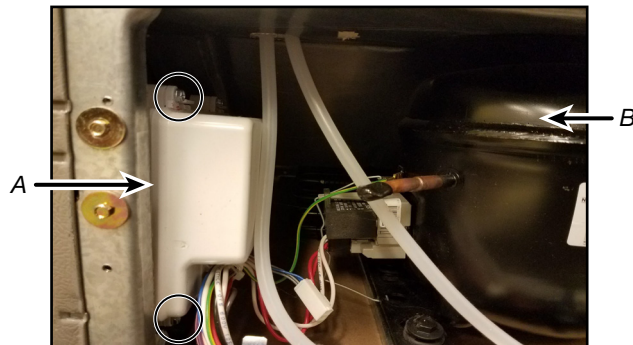

4. To remove the condenser fan, remove the two 1/4" (6.4 mm) hex head screws, disconnect the wiring and lift out.



5. To remove the Dual Water Valve, remove the two 1/4" (6.4 mm) hex head screws, disconnect the wiring and water lines then lift out.
  - A. Filter Dryer
  - B. Dual water valve

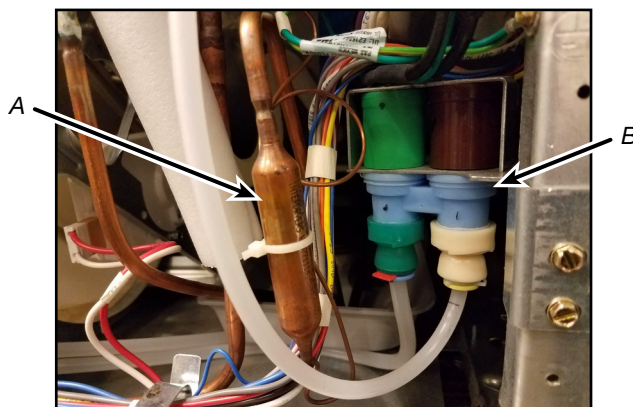

6. Below picture shows high voltage board.

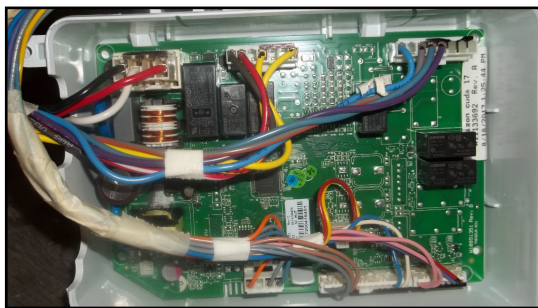

# PRODUCT SPECIFICATIONS & WARRANTY INFORMATION SOURCES

---

## ***IN THE UNITED STATES:***

**FOR PRODUCT SPECIFICATIONS AND WARRANTY INFORMATION CALL:**

FOR WHIRLPOOL PRODUCTS: 1-800-253-1301

**FOR TECHNICAL ASSISTANCE WHILE AT THE CUSTOMER'S HOME CALL:**

THE TECHNICAL ASSISTANCE LINE: 1-800-832-7174

**HAVE YOUR STORE NUMBER READY TO IDENTIFY YOU AS AN  
AUTHORIZED IN-HOME SERVICE PROFESSIONAL**

**FOR LITERATURE ORDERS (CUSTOMER EXPERIENCE CENTER):**

PHONE: 1-800-851-4605

**FOR TECHNICAL INFORMATION AND SERVICE POINTERS:**

[www.servicematters.com](http://www.servicematters.com)

---

## ***IN CANADA:***

**FOR PRODUCT SPECIFICATIONS AND WARRANTY INFORMATION CALL**

1-800-461-5681

**FOR TECHNICAL ASSISTANCE WHILE AT THE CUSTOMER'S HOME CALL:**

THE TECHNICAL ASSISTANCE LINE: 1-800-488-4791

**HAVE YOUR STORE NUMBER READY TO IDENTIFY YOU AS AN  
AUTHORIZED IN-HOME SERVICE PROFESSIONAL**



