



# CLEANVIEW® SWIVEL REWIND UPRIGHT VACUUM 3839 SERIES

What's in the Box? .....2  
Assembly .....3  
Using the Vacuum.....3  
Emptying the Dirt Tank.....5  
Automatic Cord Rewind .....5  
Cleaning the Pre-Motor Filter .....6  
Maintaining the TurboEraser® Tool .....6  
Replacing the Brush Roll and Belt .....7  
Clearing a Clog .....7  
Troubleshooting.....7  
Warranty .....7

## Product Overview

- |                        |                       |
|------------------------|-----------------------|
| 1. Wand                | 7. Cord Rewind Button |
| 2. Stretch Hose        | 8. Power Pedal        |
| 3. Wand Release Button | 9. Recline Pedal      |
| 4. Tank Release Button | 10. Swivel Steering   |
| 5. Carry Handle        | 11. Height Adjustment |
| 6. Dirt Tank           |                       |

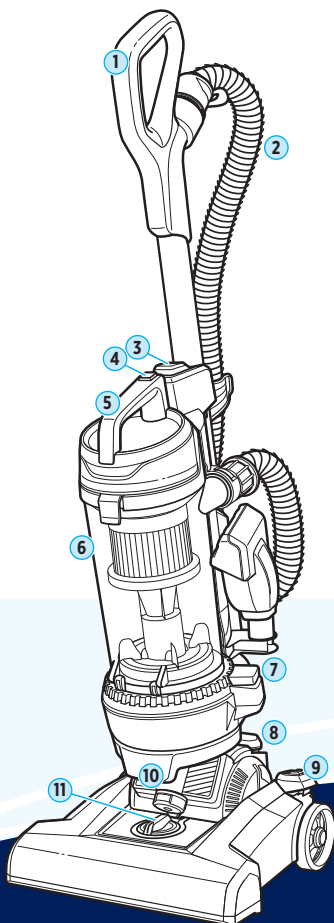

### Meet your new BISSELL® product!

Go to [support.BISSELL.com](https://support.BISSELL.com) for a walkthrough of your new purchase, including videos, tips, support, and more. Want to get started right away? This guide has all the information you need to set up your new product. Let's take a look...

# IMPORTANT SAFETY INSTRUCTIONS



## READ ALL INSTRUCTIONS BEFORE USING YOUR APPLIANCE.

When using an electrical appliance, basic precautions should be observed, including the following:

## WARNING

### TO REDUCE THE RISK OF FIRE, ELECTRIC SHOCK OR INJURY:

- Do not leave vacuum cleaner when it is plugged in. Unplug from outlet when not in use and before servicing.
- Do not use outdoors or on wet surfaces.
- Do not allow to be used as a toy. Close attention is necessary when used by or near children.
- Do not use for any purpose other than described in this user guide. Use only manufacturer's recommended attachments.
- Do not use with damaged cord or plug. If appliance is not working as it should, has been dropped, damaged, left outdoors, or dropped into water, have it repaired at an authorized service center.
- Do not pull or carry by cord, use cord as a handle, close a door on cord, or pull cord around sharp edges or corners. Do not run appliance over cord. Keep cord away from heated surfaces.
- Do not unplug by pulling on cord. To unplug, grasp the plug, not the cord.
- Do not handle plug or vacuum cleaner with wet hands.
- Do not put any object into openings. Do not use with any opening blocked; keep openings free of dust, lint, hair, and anything that may reduce air flow.
- Keep hair, loose clothing, fingers, and all parts of body away from openings and moving parts.
- Turn OFF all controls before plugging or unplugging vacuum cleaner.
- Use extra care when cleaning on stairs.
- Do not use to pick up flammable or combustible materials (lighter fluid, gasoline, kerosene, etc.) or use in areas where they may be present.
- Do not use vacuum cleaner in an enclosed space filled with vapors given off by oil-based paint, paint thinner, some moth-proofing substances, flammable dust, or other explosive or toxic vapors.
- Do not use to pick up toxic material (chlorine bleach, ammonia, drain cleaner, etc.).
- Do not pick up anything that is burning or smoking, such as cigarettes, matches or hot ashes.
- Do not use without filters in place.
- Do not pick up hard or sharp objects such as glass, nails, screws, coins, etc.
- Use only on dry, indoor surfaces.
- Keep appliance on a level surface.
- Do not carry the vacuum cleaner while it is running.
- Unplug before connecting or disconnecting the TurboEraser® Pet tool.
- Before using your vacuum, make sure the dirt tank is in locked position and that all filters, both pre- and post-filters, are in place. DO NOT operate your vacuum without these filters.
- Plastic film can be dangerous. To avoid danger of suffocation, keep away from children.
- Do not plug in your vacuum UNTIL you are familiar with all instructions and operating procedures.
- To reduce the risk of electrical shock, turn power switch OFF and disconnect polarized plug from electrical outlet BEFORE performing maintenance or troubleshooting checks.
- Hold plug when rewinding into cord reel. Do not allow plug to whip when rewinding.

## SAVE THESE INSTRUCTIONS





THIS MODEL IS FOR HOUSEHOLD USE ONLY. COMMERCIAL USE OF THIS UNIT voids the MANUFACTURER'S WARRANTY.

## THIS APPLIANCE HAS A POLARIZED PLUG

To reduce the risk of electric shock, this appliance has a polarized plug (one blade is wider than the other). This plug will fit in a polarized outlet only one way. If the plug does not fit fully in the outlet, reverse the plug. If it still does not fit, contact a qualified electrician to install a proper outlet. Do not change the plug in any way.

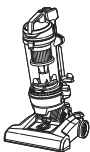
## What's in the Box?

Standard accessories vary by model. To identify what should be included with your purchase, please refer to the "Carton Contents" list located on the carton top flap.

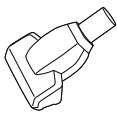
				
Base	Wand	Hose	2-in-1 Dusting Brush and Crevice Tool	TurboEraser® Pet Tool

## Assembly

▶ Go to [support.BISSELL.com](https://support.BISSELL.com) for assembly videos.



**1.** Attach wand to vacuum base.

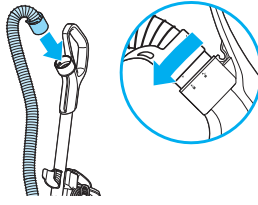

**2.** Attach stretch hose to wand and twist clockwise to lock into place.

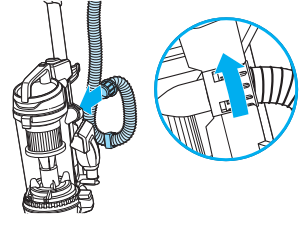

**3.** Attach stretch hose to back of vacuum and twist clockwise to lock into place.

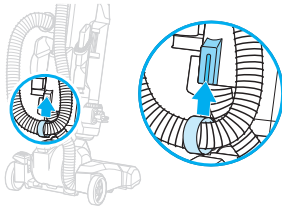

**4.** Attach hose clip to body of vacuum by sliding up until it clicks into place. Remove hose clip for extended cleaning reach when in use.



**5.** The hose should sit on the vacuum without any twists.

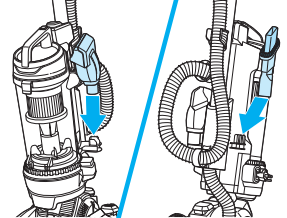

**6.** Attach tools to tool holders.

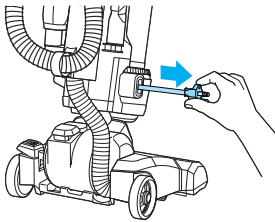

## Using the Vacuum

▶ For additional support videos and information, visit [support.BISSELL.com](https://support.BISSELL.com).

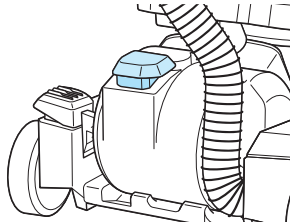

**1.** Gently pull the cord out, stopping at the yellow mark on the cord. Do not pull past the red mark.



**2.** Press the red power button with your foot to turn the vacuum ON  and OFF .

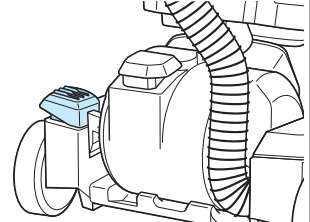

**3.** Press the recline pedal and pull handle back towards you.

CONTINUED ON NEXT PAGE 

## Using the Vacuum (continued)

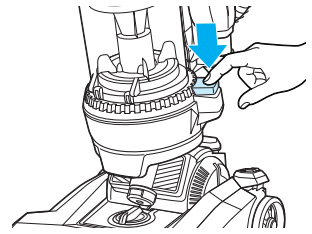
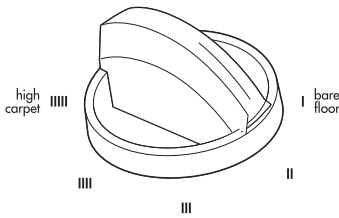

**1.** Turn dial on foot to desired height setting. If dial is difficult to turn, tilt the vacuum back slightly to take the weight off the foot while turning.

**Tip:** For best performance, adjust to the lowest practical setting. If your vacuum is difficult to push, adjust to the next higher setting.

**2.** Hold onto the plug and press automatic cord rewind button until fully retracted. If cord doesn't fully retract on the first try, pull a little bit of cord out and press the rewind button again.

**Note:** Rotating floor brush continues to rotate while tools are in use. Never place fingers under the vacuum when it is running. Never place powerfoot on furniture or uneven surfaces.

Certain carpets and low humidity conditions may generate small static discharges. Static discharges are entirely harmless and are not associated in any way with the main power supply.

## Above Floor Cleaning

Clean hard-to-reach spaces with the Quick Release Extension Wand.

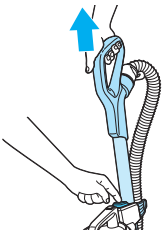

**1.** Press the wand release button to remove extension wand and attach desired tool.

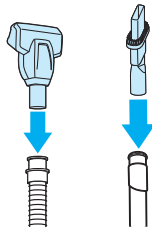

**2.** Attach desired tool.  
**Note:** For optimal performance, attach the TurboEraser® Pet tool directly to the hose instead of the wand.

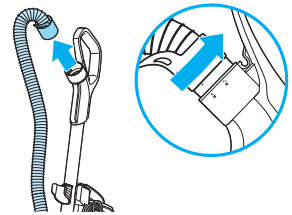

**3.** Twist hose counter-clockwise to remove from handle, if desired. To do so, twist circular hose cuff counter-clockwise and remove from handle.

**⚠ WARNING** To reduce the risk of injury from moving parts while the vacuum is turned ON, always move the vacuum via the rolling wheels by using the upper handle at the back of the vacuum. Do not carry the vacuum while it is running. Always place vacuum on floor with handle in upright position when using tools.

## Emptying the Dirt Tank

↖ We have additional tips for maintaining your machine at [support.BISSELL.com](https://support.BISSELL.com).

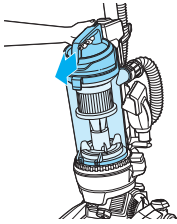

**1.** Press the tank release button and pull out to remove dirt tank.

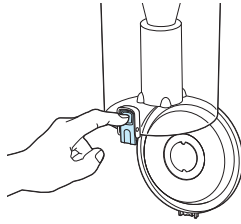

**2.** Hold the dirt tank over a trash bin. Press the bottom release button to empty.

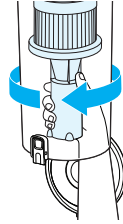

**3.** Twist cyclone counter-clockwise and pull down to remove from tank.

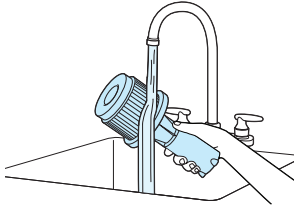

**4.** Clean cyclone with warm water and mild detergent. Let dry for 24 hours before reinstalling.

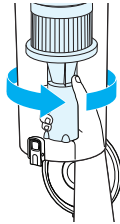

**5.** Twist cyclone clockwise to reinstall.

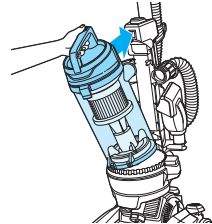

**6.** Place tank back on vacuum and press firmly until it clicks into place.

## Automatic Cord Rewind

▶ If you have trouble with this feature, see our troubleshooting videos on [support.BISSELL.com](https://support.BISSELL.com).

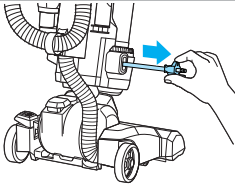

**1.** Gently pull the cord out. Do not pass the red mark on the cord. Plug cord into an outlet.

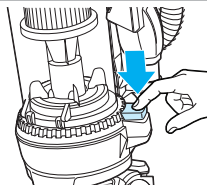

**2.** To retract, hold the plug and press the automatic cord rewind button.

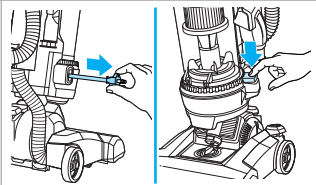

**3.** If cord doesn't fully retract, pull some of the cord out and press the button again.

**⚠ WARNING** To reduce the risk of electric shock, turn power OFF and disconnect plug from electrical outlet before performing maintenance or troubleshooting checks.

## Cleaning the Pre-Motor Filter

Find replacement filters at [BISSELL.com](http://BISSELL.com).

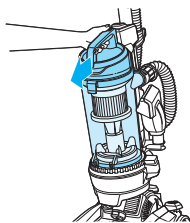

**1.** Press the tank release button and pull out to remove dirt tank.

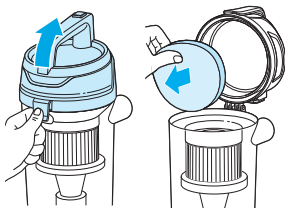

**2.** Lift release latch to access filter. Remove foam filter from lid.

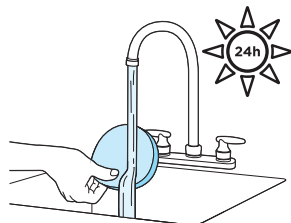

**3.** Hand wash in warm water and rinse well; mild detergent may be used if desired. Let dry for 24 hours before reinstalling.

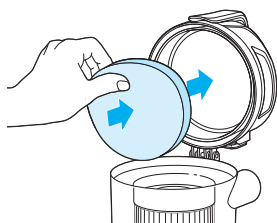

**4.** Reinstall foam filter and close lid.

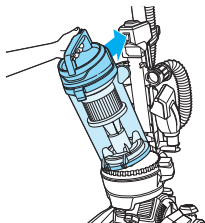

**5.** Place tank back on vacuum and press firmly until it clicks into place.

## Maintaining the TurboEraser® Tool

For more helpful maintenance tips, check out [support.BISSELL.com](http://support.BISSELL.com).

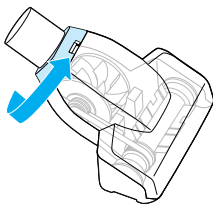

**1.** Twist gray collar counter-clockwise, until slot appears, then separate faceplate.

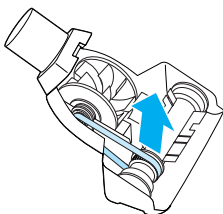

**2.** Remove brush roll, belt and paddle wheel. Inspect for damages and replace if necessary.

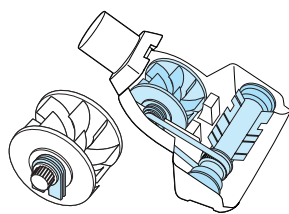

**3.** To reassemble, align two clips on each end of paddle wheel with belt on and pop back into place. Place brush roll with belt back in. Faceplate will not close properly if all parts are not aligned correctly.

## ⚠ WARNING

- To reduce the risk of electric shock, turn power OFF and disconnect plug from electrical outlet before performing maintenance or troubleshooting checks.
- Do not operate vacuum with damp or wet filters or without all filters in place.

## Replacing the Brush Roll and Belt

For additional support videos and information, visit [support.BISSELL.com](https://support.BISSELL.com).

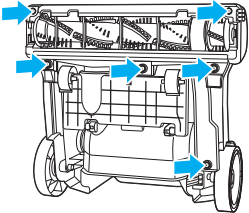
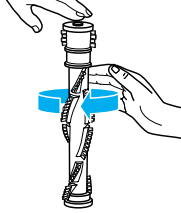
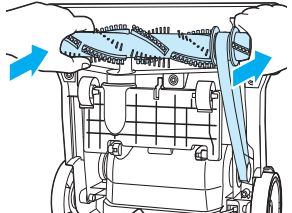
		
<p><b>1.</b> Unplug vacuum, turn over and unscrew six (6) Phillips-head screws to remove the bottom cover. Lift brush straight out.</p>	<p><b>2.</b> Clean debris from brush roll. Inspect by placing on its end and spinning. The brush roll should spin freely, multiple times by one flick. If it doesn't, replace brush roll. Check belt for wear or cuts and replace if necessary.</p>	<p><b>3.</b> Replace the brush roll and belt by looping the belt over the motor shaft and the brush roll. Line up the endcaps and pull the brush forward into place. This will stretch the belt. Return bottom cover back on and replace the screws.</p>

## Clearing a Clog

We have additional tips for maintaining your machine at [support.BISSELL.com](https://support.BISSELL.com).

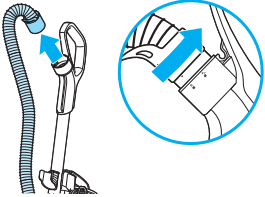
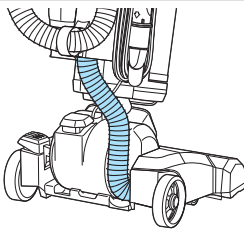
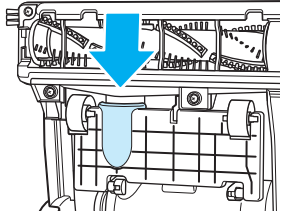
		
<p><b>1.</b> Remove the hose from the back of the vacuum by twisting it counter-clockwise. Remove any debris.</p>	<p><b>2.</b> Check the foot hose on the back. If necessary, remove the screw from the foot hose and check for clogs.</p>	<p><b>3.</b> Check the air passageway on the bottom of your vacuum. Remove the bottom cover and the brush. Remove any debris.</p>

**Note:** Any other maintenance or servicing not included in this manual should be performed by an authorized service representative.

## Troubleshooting

For a comprehensive walkthrough of your product and support tips visit [support.BISSELL.com](https://support.BISSELL.com).

## Warranty

Limited 4-year warranty, may vary by state. Visit [support.BISSELL.com](https://support.BISSELL.com) or call 1-800-237-7691 for complete warranty information.

**⚠ WARNING** To reduce the risk of electric shock, turn power OFF and disconnect plug from electrical outlet before performing maintenance or troubleshooting checks.



## We're Waggin' Our Tails!

BISSSELL proudly supports BISSSELL Pet Foundation® and its mission to help save homeless pets. When you buy a BISSSELL® product, you help save pets, too. We're proud to design products that help make pet messes, odors and pet homelessness disappear.

Visit [BISSSELLsavespets.com](https://www.bissellsavespets.com) to learn more.

## But wait, there's more!

Join us online for a complete guide to your new product, including troubleshooting, product registration, parts, and more.

Go to [support.BISSSELL.com](https://support.bissell.com).



REGISTER



INFO



VIDEOS



PARTS



SUPPORT



©2024 BISSSELL Inc. All rights reserved.  
Part Number 1635358 01/24 v8