

# SAMSUNG

## Product Guide

## 5101 Series Refrigerator

**RF18A5101SR**

**RF18A5101SG**

**RF18A5101WW**

**RF18A5101S9**

Available in:

Fingerprint Resistant Stainless Steel

Fingerprint Resistant Black Stainless Steel

Fingerprint Resistant White

Fingerprint Resistant Stainless Look



# Product Overview

## Product Title

18 cu. ft. Smart Counter Depth 3-Door French Door Refrigerator

## Product Description (122 characters)

33" wide Smart Counter Depth 3-Door French Door Refrigerator with a modern look that blends seamlessly into your kitchen.

## Easy Ads Links

**Stainless Steel:** <https://dam.gettyimages.com/p/z0c3461/digital-appliances?o=AND&q=RF18A5101SR>

**Black Stainless Steel:** <https://dam.gettyimages.com/p/z0c3461/digital-appliances?o=AND&q=RF18A5101SG>

**White:** <https://dam.gettyimages.com/p/z0c3461/digital-appliances?o=AND&q=RF18A5101WW>

**Stainless Look:** <https://dam.gettyimages.com/p/z0c3461/digital-appliances?o=AND&q=RF18A5101S9>

## Available Colors



**Fingerprint Resistant  
Stainless Steel**  
RF18A5101SR



**Fingerprint Resistant  
Black Stainless Steel**  
RF18A5101SG

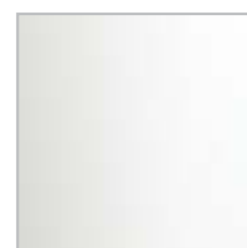

**Fingerprint Resistant  
White**  
RF18A5101WW



**Fingerprint Resistant  
Stainless Look**  
RF18A5101S9





# Carousel Image Order



360 Spin not available in Stainless Look.





Twin Cooling Plus









## Features and Benefits

Headline	Feature Name	Long Body Copy	Short Body Copy	Associated Image
<p><b>Seamlessly designed for a modern, built-in look</b></p>	<p><b>Counter Depth</b></p>	<p>Built-in look for a seamless fit. The smooth and streamlined exterior design features beautiful flat doors and easy-to-open recessed handles that blend seamlessly into your cabinetry, adding function and style to your kitchen.</p>	<p>Modern, built-in look that blends seamlessly into your kitchen.</p>	
<p><b>Stay connected, anywhere, anytime</b></p>	<p><b>Wi-Fi Enabled</b></p>	<p>Use the SmartThings App* on your smartphone to control the temperature and monitor your refrigerator remotely.</p> <p><small>*Available on Android and iOS devices. A Wi-Fi connection and a Samsung account are required.</small></p>	<p>Control and monitor your fridge remotely.</p>	
<p><b>ENERGY STAR® Certified</b></p>	<p><b>ENERGY STAR® Certified</b></p>	<p>Eco-friendly and energy-efficient.*</p> <p><small>*Visit <a href="http://www.energystar.gov">www.energystar.gov</a> for more information on ENERGY STAR® guidelines.</small></p>	<p>Eco-friendly and energy-efficient.*</p> <p><small>*Visit <a href="http://www.energystar.gov">www.energystar.gov</a> for more information on ENERGY STAR® guidelines.</small></p>	

## Features and Benefits (Continued)

Headline	Feature Name	Long Body Copy	Short Body Copy	Associated Image
N/A	<b>Fingerprint Resistant Finish</b>	A finish that withstands everyday smudges, so you spend less time cleaning.	Less smudging means less cleaning.	
N/A	<b>Twin Cooling Plus®</b>	Independent fridge and freezer controls keep food fresher, longer.	Keeps food fresher, longer.	
N/A	<b>Accessibility (ADA Compliant)</b>	Easy-to-reach controls for everyone.	Easy-to-reach controls.	

## Features and Benefits (Continued)

Headline	Feature Name	Long Body Copy	Short Body Copy	Associated Image
N/A	LED Lighting	LED lighting designed to beautifully light up the interior of your fridge so you can quickly spot what you want.	LED lighting designed to beautifully light up the interior of your fridge.	
On-demand cooling	Power Cool & Freeze	Quickly freeze or chill your food with the Power Freeze or Power Cool options – lowers the temperature with the push of a button.	Fast cooling and freezing on demand.	



# Feature Videos



Product Overview



Modern Design



Twin Cooling Plus®

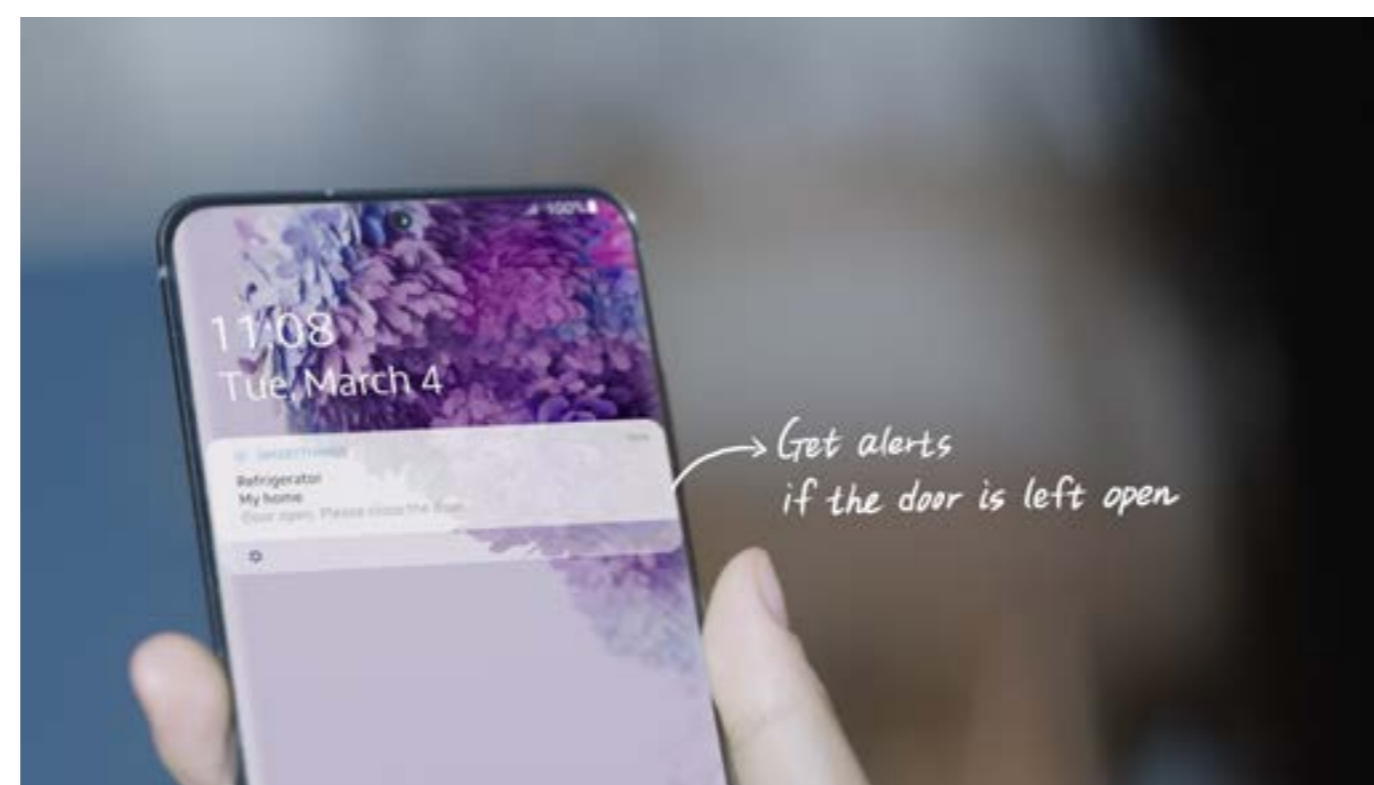

Wi-Fi Enabled



# Spec Sheets, User Manual & Energy Guide

**RF18A5101**
**SAMSUNG**

**17.5 cu. ft. Smart Counter Depth 3-Door French Door Refrigerator**



**Signature Features**

**Counter Depth**  
Built-in look for a seamless fit. The smooth and streamlined exterior design features beautiful flat doors and easy-to-open recessed handles that blend seamlessly into your cabinetry, adding function and style to your kitchen.



**Wi-Fi Enabled**  
Use the SmartThings App<sup>®</sup> on your smartphone to control the temperature and monitor your refrigerator remotely.

**ENERGY STAR<sup>®</sup> Certified**  
Eco-friendly and energy-efficient.<sup>2</sup>

**Fingerprint Resistant Finish**  
A finish that withstands everyday smudges, so you spend less time cleaning.

**Available Colors**

- Fingerprint Resistant Stainless Steel (shown)
- Fingerprint Resistant Black Stainless Steel
- Fingerprint Resistant Stainless Look

**Design**

- Counter Depth
- Recessed Handle
- Flat Door Design
- Fingerprint Resistant Finish
- LED Lighting
- Gallon Door Bins
- Humidity-Controlled Crispers

**Technology**

- Wi-Fi Enabled
- Adjustable Top Freezer Shelf
- Door Alarm
- Sabbath Mode

**Performance**

- Twin Cooling Plus<sup>®</sup>
- Power Cool & Freeze
- Ice Maker - Stores up to 5.5 lbs of ice

**Rating**

ENERGY STAR<sup>®</sup> rated: 540 kWh/yr

**ADA Compliant**

Spec Sheet - front

**RF18A5101**
**SAMSUNG**

**17.5 cu. ft. Smart Counter Depth 3-Door French Door Refrigerator**

**Installation Specifications**

- Measure the height, width and depth of the opening, making sure to include baseboards, molding tile, countertop overhang, etc. Check to be sure there is enough room to open the door (consider walls, islands or other obstacles when measuring).
- Refer to illustration below to determine dimensions.
- Allow 1/4" of clearance on hinge side of refrigerator when installing next to a wall where door may make contact.
- Allow 2" minimum clearance at rear for proper air circulation and water/electrical connections. Allow a 3/4" minimum clearance at sides and top for ease of installation.
- Ensure each door and entryway in the home is wide enough for the refrigerator to be moved through easily.

For optimal usage and ability to open refrigerator doors completely, do not install next to a wall.

Please note: The following dimension and cutout information is for planning purposes only. For complete installation details, consult manual packed with product or download manual online at [samsung.com](http://samsung.com).

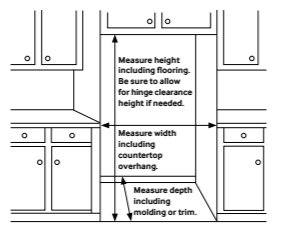

**Dimensions**

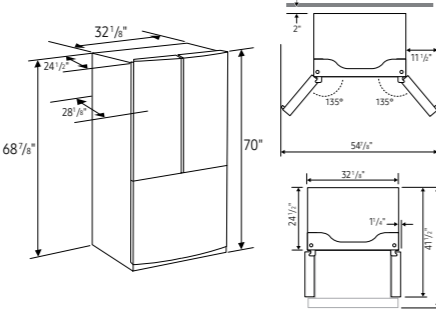

**Total Capacity: 17.5 cu. ft.**

**Refrigerator: 11.7 cu. ft.**

- 3 Tempered Glass Spill-Proof Shelves
- 2 Humidity-Controlled Crispers
- 6 Door Bins
  - Right Door: 1 Gallon Bin, 2 Regular Bins
  - Left Door: 1 Gallon Bin, 2 Regular Bins
- LED Lighting

**Freezer: 5.8 cu. ft.**

- Automatic Ice Maker
- EZ-Open Handle<sup>™</sup>
- LED Lighting

**Warranty**

One (1) Year Parts and Labor on Refrigerator  
Five (5) Years Parts and Labor on Sealed Refrigeration System Only\*  
Ten (10) Years Parts and Five (5) Years Labor on Digital Inverter Compressor  
\*Compressor, evaporator, condenser, drain and connecting tubing

**Product Dimensions & Weight**  
Dimensions (WxHxD with hinges, and doors): 32 1/2" x 70" x 28 1/2"  
Dimensions (WxHxD without hinges and door): 32 1/2" x 68 1/2" x 24 1/2"  
Weight: 205 lbs

**Shipping Dimensions & Weight (WxHxD)**  
Dimensions: 34 1/2" x 75" x 30 1/2"  
Weight: 223 lbs

Color	Model #	UPC Code
Fingerprint Resistant Stainless Steel	RF18A5101SR	887276455167
Fingerprint Resistant Black Stainless Steel	RF18A5101SG	887276465449
Fingerprint Resistant Stainless Look	RF18A5101S9	887276799261

Actual color may vary. Design, specifications, and color availability are subject to change without notice. Non-metric weights and measurements are approximate. ©2023 Samsung Electronics America, Inc., 45 Challenger Road, Ridgefield Park, NJ 07663. Tel: 800-SAMSUNG, [samsung.com](http://samsung.com). Samsung is a registered trademark of Samsung Electronics Co., Ltd.

Spec Sheet - back

**19.5 cu. ft. French Door**
**SAMSUNG**

**MODEL RF20A5101 DIMENSIONS**

**Be sure your new fridge will fit**  
Don't wait until delivery to be sure your new refrigerator will fit – both in your kitchen and through all doorways. This guide includes all pertinent measurements and clearances so you can buy with confidence.

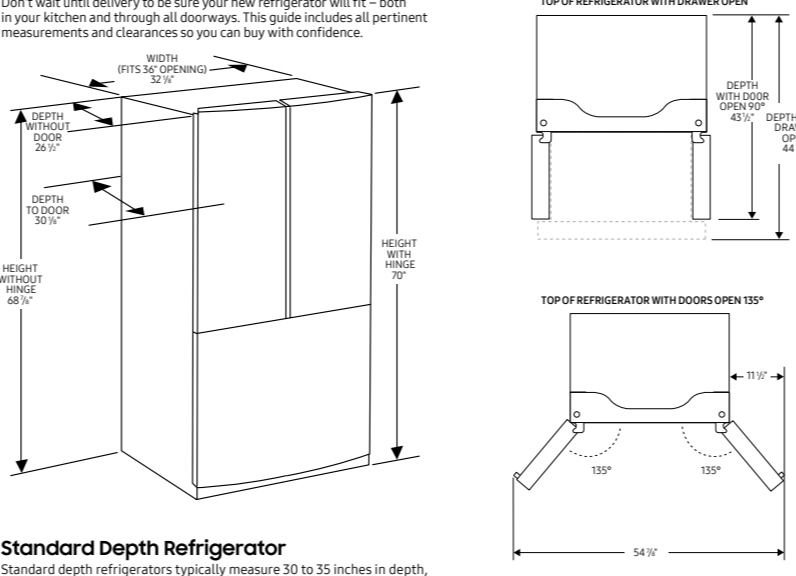

**Standard Depth Refrigerator**  
Standard depth refrigerators typically measure 30 to 35 inches in depth, as opposed to counter depth refrigerators that sit flush with cabinetry.

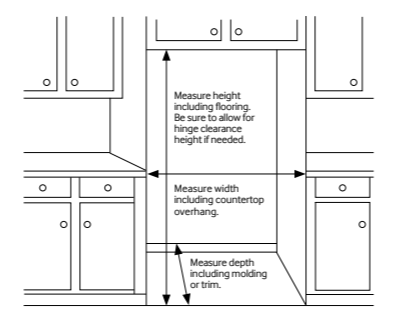

**Installation clearances**

- Allow 3 3/4" of clearance when installing along a wall. This will allow for the door to open 90 degrees without the handle contacting the wall.
- Allow 2" minimum clearance at rear for proper air circulation and water/electrical connections.
- Allow a 1/8" minimum clearance at sides and top for ease of installation.

**For optimal usage and ability to open refrigerator doors completely, do not install next to a wall.**

Please note: The above dimension and cutout information is for planning purposes only. For complete installation details, consult manual packed with product or download manual online at [samsung.com](http://samsung.com).

**Walk the delivery route**

- Identify the narrowest opening that the appliance will travel through, from outside the home to the location where it will be installed.
- Appliance depth or width must be smaller than the width of the narrowest opening.

Will It Fit Guide

**Refrigerator**

---

**User manual**

RF18A5101\*\*/RF20A5101\*\*

Free Standing Appliance

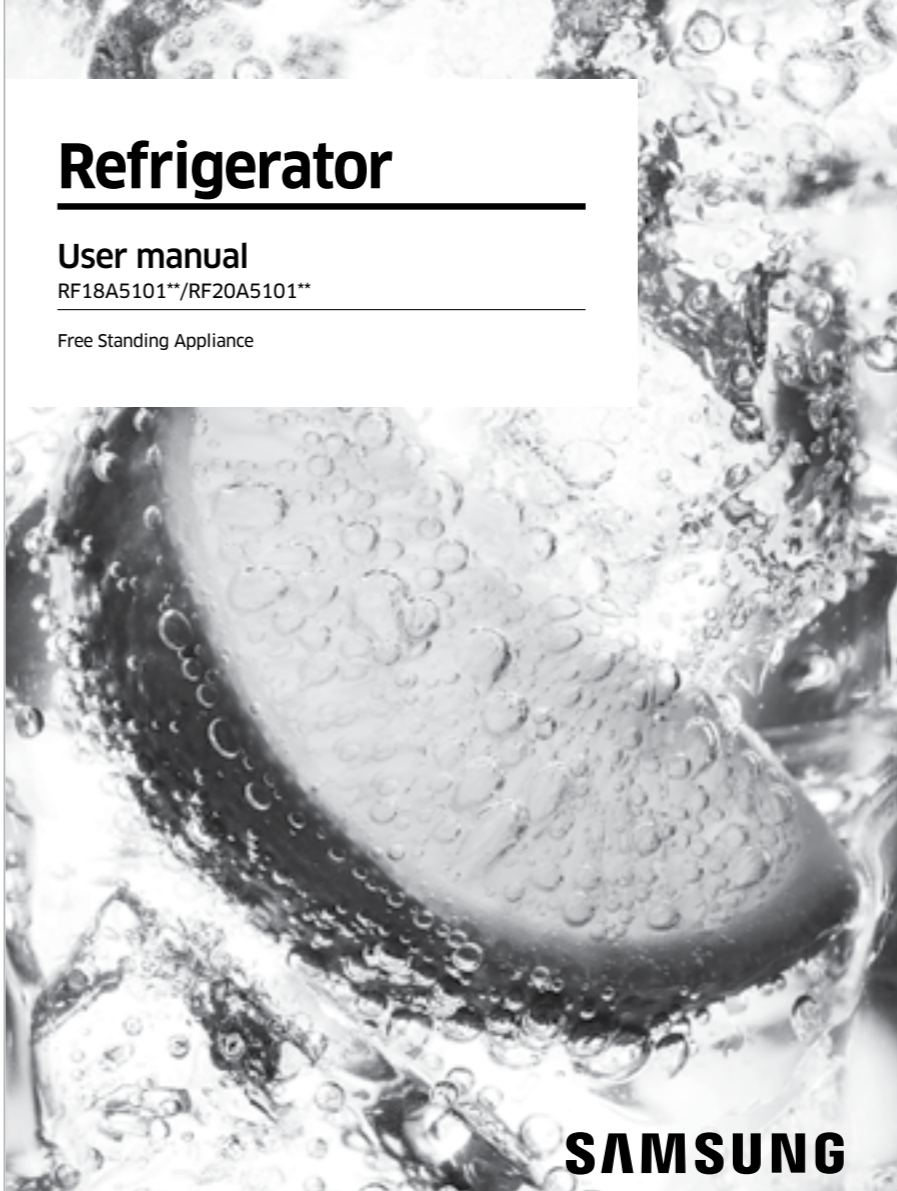

SAMSUNG

User Manual

U.S. Government Federal law prohibits removal of this label before consumer purchase.

# ENERGYGUIDE

Refrigerator-Freezer

- Automatic Defrost
- Bottom-Mounted Freezer
- No Through-the-Door Ice

Samsung  
Model RF18A5101\*\*  
Capacity: 17.5 Cubic Feet

---

Compare ONLY to other labels with yellow numbers.  
Labels with yellow numbers are based on the same test procedures.

---

Estimated Yearly Energy Cost

## \$76

Cost Range	Models with similar features	\$60	\$86
All models	\$38		\$90

---

540 kWh

Estimated Yearly Electricity Use

- Your cost will depend on your utility rates and use.
- Both cost ranges based on models of similar size capacity.
- Models with similar features have automatic defrost, bottom-mounted freezer, and no through-the-door ice.
- Estimated energy cost based on a national average electricity cost of 14 cents per kWh.

[ftc.gov/energy](http://ftc.gov/energy)

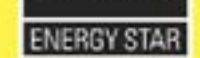
Energy Guide



# Feature Icons

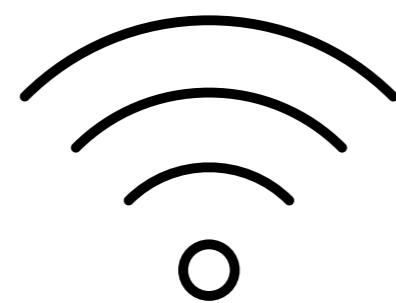

Wi-Fi Enabled



ENERGY STAR® Certified

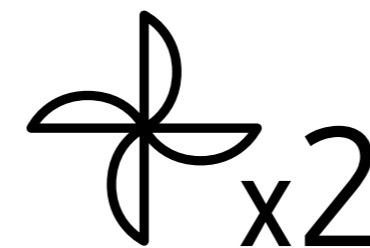

Twin Cooling Plus®



LED Lighting

**SAMSUNG**