

SAMSUNG

Product Guide

31 cu. ft. Mega Capacity 3-Door French Door Refrigerator with Four Types of Ice

RF32CG5400

Available in:

Fingerprint Resistant Stainless Steel

Fingerprint Resistant Matte Black Steel



Table of Contents

Product Overview

Product Overview	4
Carousel Image Order	5

Product Messaging

Features and Benefits	8
Primary Lifestyle Image	12
Videos	13

Product Specs

Spec Sheet	15
<i>Will It Fit?</i> Guide	16
Energy Guide and User Manual	17
Warranty	18

Feature Icons	20
----------------------	-----------

Product Overview

**RF32CG5400 – 31 cu. ft. Mega Capacity 3-Door French Door
Refrigerator with Four Types of Ice**

Product Overview

Product Titles

31 cu. ft. Mega Capacity 3-Door French Door Refrigerator with Four Types of Ice in Stainless Steel

31 cu. ft. Mega Capacity 3-Door French Door Refrigerator with Four Types of Ice in Matte Black Steel

Product Description (Paragraph)

Samsung Mega Capacity 3-Door French Door refrigerator with 31 cu. ft. comes with four types of ice and a modern design. Store more groceries, including big and bulky items. The Dual Auto Ice Maker makes two types of ice – cubed, or Ice Bites™ while the external dispenser offers two additional ice options, curved and crushed.

Product Description (Bullets)

- 31 cu. ft. Mega Capacity 3-Door French Door refrigerator in in Stainless Steel or Matte Black Steel.
- Dual Auto Ice Maker makes two types of ice – cubed, or Ice Bites™ – while the external dispenser offers two additional ice options, curved and crushed.
- A flat-front design with recessed drawer handle blends beautifully into your kitchen.
- 13% more space*

*Compared to 2022 model.

Easy Ads Links

Stainless Steel: <https://dam.gettyimages.com/p/z0c3461/digital-appliances?o=AND&q=RF32CG5400SR>

Matte Black Steel: <https://dam.gettyimages.com/p/z0c3461/digital-appliances?o=AND&q=RF32CG5400MT>

Available Colors



**Fingerprint Resistant
Stainless Steel**

RF32CG5400SR



**Fingerprint Resistant
Matte Black Steel**

RF32CG5400MT



RF32CG5400SR Carousel Image Order





RF32CG5400MT Carousel Image Order



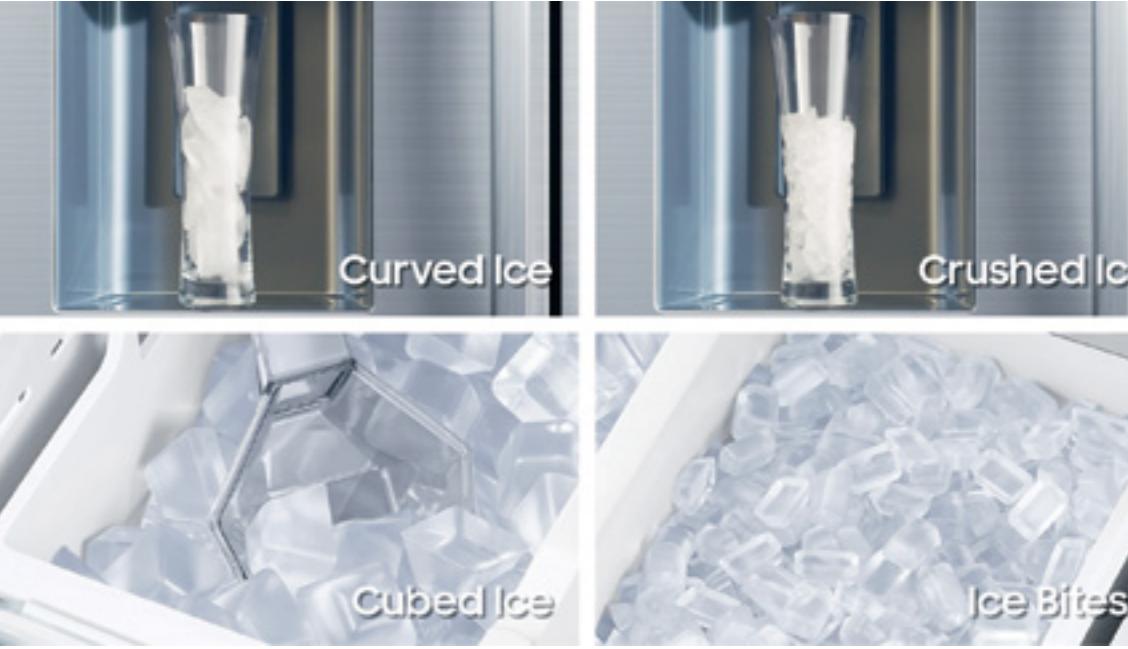

Product Messaging



**RF32CG5400 – 31 cu. ft. Mega Capacity 3-Door French Door
Refrigerator with Four Types of Ice**

Features and Benefits – RF32CG5400				
Overall Product Headline	Feature Name	Long Body Copy	Short Body Copy	Associated Image
Mega capacity refrigerator	31 cu. ft. Mega Capacity	Store more groceries with more room to stay organized. 31 cu. ft. mega capacity refrigerator gives you more space with easy access to everything you need.	31 cu. ft. mega capacity refrigerator stores more groceries with extra room.	
More ice choices	Four Types of Ice	Enjoy your favorite beverage with your choice of ice. Choose from cubed ice or Ice Bites™ from the Dual Auto Ice Maker in the freezer drawer, or choose from curved or crushed ice from the external dispenser.	Get four types of ice: cubed, Ice Bites™, curved, or crushed.	
Modern design	Modern Design	A flat-front refrigerator design with recessed drawer handle blends beautifully into your kitchen.	Modern refrigerator design with recessed drawer handle.	

Features and Benefits – RF32CG5400 (Continued)

Overall Product Headline	Feature Name	Long Body Copy	Short Body Copy	Associated Image
<p>Monitor and control energy usage</p>	<p>SmartThings Energy®</p>	<p>SmartThings lets you monitor and manage your smart refrigerator's power usage. Get energy saving tips and alerts to help lower your electric bill, right from your phone.*</p> <p><small>*Available on Android and iOS devices. A Wi-Fi connection and a Samsung account are required.</small></p>	<p>SmartThings lets you monitor and manage your smart refrigerator's power usage all from your phone.*</p> <p><small>*Available on Android and iOS devices. A Wi-Fi connection and a Samsung account are required.</small></p>	
<p>Store it all, short and tall</p>	<p>Slide-in Shelf</p>	<p>The adjustable slide-in shelf is flexibly designed to fit in just half of the fridge, so you can slide it back to create more room for tall and bulky items.</p>	<p>Adjustable shelf lets you store tall items with ease.</p>	 <p>Asset also available as .mp4.</p>
<p>Keeps food fresher</p>	<p>Metal Cooling</p>	<p>Metal Cooling locks in cold and seals in freshness. The stainless steel paneling helps maintain consistent temperature throughout the refrigerator.</p>	<p>Metal Cooling helps maintain an optimal temperature inside the fridge.</p>	 <p>Additional asset also available as .mp4.</p>

Features and Benefits – RF32CG5400 (Continued)

Overall Product Headline	Feature Name	Long Body Copy	Short Body Copy	Associated Image
<p>Even cooling from corner to corner</p>	<p>All-Around Cooling</p>	<p>All-Around Cooling uses evenly spaced vents and monitors temperature continuously to ensure consistent cooling from corner to corner. This keeps the interior temperature the same throughout the fridge, so everything stays fresher, longer.</p>	<p>Cools refrigerator evenly from corner to corner, so food stays fresher, longer.</p>	
<p>Easy access to fresh water</p>	<p>External Water Dispenser* <small>*Bisphenol A (BPA) is found in polycarbonate plastics and epoxy resins, which are often used in food and beverage containers, and has been linked with possible adverse health effects.</small></p>	<p>External water dispenser gives you easy access to chilled, filtered water.</p>	<p>Easy access to chilled and filtered water.</p>	
<p>ADA Compliant</p>	<p>ADA Compliant</p>	<p>Easy-to-reach controls for everyone.</p>	<p>Easy-to-reach controls.</p>	

Features and Benefits – RF32CG5400 (Continued)				
Overall Product Headline	Feature Name	Long Body Copy	Short Body Copy	Associated Image
Digital Inverter Compressor with 10-year warranty	10-year Warranty	Get a 10 year warranty on parts, and 5 years of coverage for labor, on the Digital Inverter™ Compressor.	10-year warranty on the compressor.	 <p>The image shows a black badge with '10 YEAR WARRANTY' in large white text. Below it, in smaller text, it says 'ON THE COMPRESSOR' and 'DIGITAL INVERTER™ TECHNOLOGY'. At the bottom, there are three circular icons: a leaf for 'Energy Savings', a speaker with a slash for 'Less Noise', and a '10 YEAR' icon for 'Undoubtable Durability'.</p>

Primary Lifestyle Image

For use on marketing landing pages, category pages and offsite landing pages.



Stainless Steel (Preferred image for marketing usage.)



Black Matte Steel

Videos



Large Capacity



4 Types of Ice



SmartThings Connectivity



Slide-In Shelf

Product Specs

RF32CG5400 – 31 cu. ft. Mega Capacity 3-Door French Door Refrigerator with Four Types of Ice

Spec Sheet

RF32CG5400

31 cu. ft. Mega Capacity 3-Door French Door Refrigerator with Four Types of Ice



SAMSUNG

Signature Features

Mega 31 cu. ft. Capacity
Store more groceries with more room to stay organized. Mega 31 cu. ft. capacity fits big bulky items and provides easy access to everything you need.

Four Ice Types
Enjoy your favorite beverage with your choice of ice. Choose cubed ice or Ice Bites™ from the Dual Ice Maker in the freezer drawer, or opt for curved or crushed ice from the external dispenser.

Modern Design
A flat-front design with low-profile door handles and recessed drawer handle fit seamlessly into your kitchen.



Mega 31 cu. ft. Capacity



Refrigerator: Curved and Crushed Ice Freezer: Cubed and Ice Bites™

Available Colors

- Fingerprint Resistant Stainless Steel (shown)
- Fingerprint Resistant Matte Black Steel

Design

- Premium External Filtered Water and Ice Dispenser
- Mega Capacity of 31 cu. ft.
- High-Efficiency LED Lighting
- Gallon Door Bin
- Fingerprint Resistant Finish

Technology

- Wi-Fi Enabled
- Power Cool & Power Freeze
- Door Alarm
- Water Filter Indicator

Performance

- Four Ice Types: Crushed, Curved, Cubed and Ice Bites™
- SmartThings Energy*
- Metal Cooling

*Available on Android and iOS devices. A Wi-Fi connection and a Samsung account are required.

SmartThings

ADA Compliant

Rating

ENERGY STAR® rated:
786 kWh/yr

RF32CG5400

31 cu. ft. Mega Capacity 3-Door French Door Refrigerator with Four Types of Ice

SAMSUNG

Installation Specifications

1. Measure the height, width and depth of the opening, making sure to include baseboards, molding tile, countertop overhang, etc. Check to be sure there is enough room to open the door (consider walls, islands or other obstacles when measuring).
2. Refer to illustration below to determine dimensions.
3. Allow 2.5" of clearance on hinge side of refrigerator when installing next to a wall where handle may make contact.
4. Allow 1" minimum clearance at rear for proper air circulation and water/electrical connections. Allow a 3/8" minimum clearance at sides and top for ease of installation.
5. Ensure each door and entryway in the home is wide enough for the refrigerator to be moved through easily.

For optimal usage and ability to open refrigerator doors completely, do not install next to a wall.

Please note: The following dimensions and cutout information is for planning purposes only. For complete installation details, consult manual packed with product or download manual online at samsung.com.

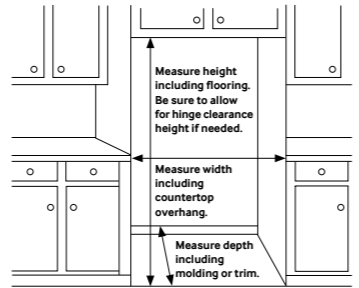

Total Capacity: 30.5 cu. ft.

Refrigerator: 21.3 cu. ft.

- External Filtered Water and Ice Dispenser
- 4 Tempered Glass Spill-Proof Shelves
- Full-Width Drawer
- 2 Clear Drawers
- 7 Door Bins
- Right: 1 Gallon Bin, 3 Regular Bins
- Left: 3 Regular Bins
- High-Efficiency LED Lighting

Freezer: 9.2 cu. ft.

- Dual Ice Maker in Freezer (Cubed Ice or Ice Bites™)
- 2 Removable Ice Buckets and 1 Scoop
- 1 Large Opaque Bin with 1 Divider
- High-Efficiency LED Lighting

Accessories

Water Filter: HAF-QIN

Warranty

One (1) Year Parts and Labor on Refrigerator
Five (5) Years Parts and Labor on Sealed Refrigeration System Only*
Ten (10) Years Parts and Five (5) Years Labor on Digital Inverter Compressor

*Compressor, evaporator, condenser, drier and connecting tubing.

Product Dimensions & Weight

Dimensions (WxHxD with hinges, handles and doors):
35 3/4" x 70" x 36 1/4"

Dimensions (WxHxD without hinges and door):
35 3/4" x 68 7/8" x 29 1/2"

Dimensions (WxHxD with hinge and door, no handle):
35 3/4" x 70" x 34 5/8"

Weight: 306 lbs

Shipping Dimensions & Weight (WxHxD)

Dimensions: 37 1/4" x 75 1/8" x 36"

Weight: 316 lbs

Dimensions

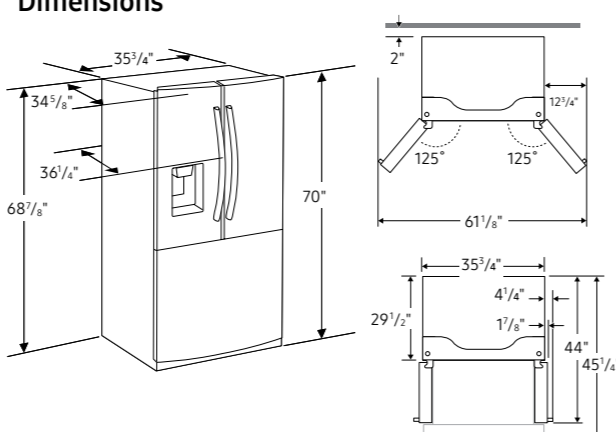

Color	Model #	UPC Code
Fingerprint Resistant Stainless Steel	RF32CG5400SR	887276769332
Fingerprint Resistant Matte Black Steel	RF32CG5400MT	887276769325

Actual color may vary. Design, specifications, and color availability are subject to change without notice. Non-metric weights and measurements are approximate.
©2023 Samsung Electronics America, Inc., 85 Challenger Road, Ridgefield Park, NJ 07660. Tel: 800-SAMSUNG. samsung.com. Samsung is a registered trademark of Samsung Electronics Co., Ltd.

Spec Sheet - front

Spec Sheet - back

Will It Fit? Guide

31 cu. ft. 3-Door French Door Refrigerator
SAMSUNG

MODEL RF32CG5400 DIMENSIONS

Be sure your new fridge will fit
 Don't wait until delivery to be sure your new refrigerator will fit – both in your kitchen and through all doorways. This guide includes all pertinent measurements and clearances so you can buy with confidence.

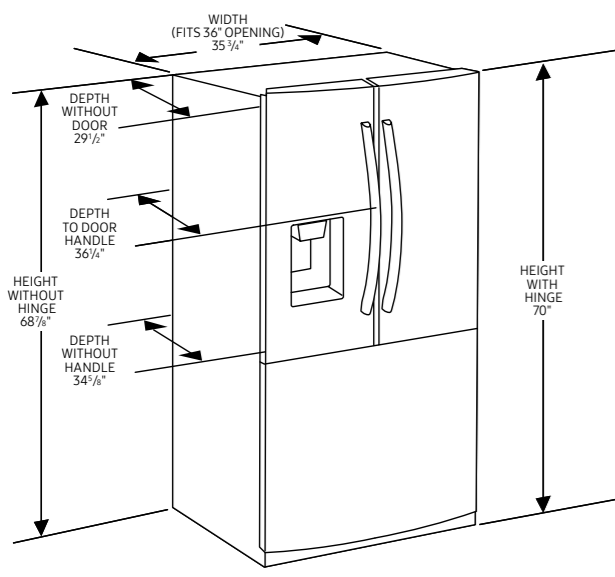

WIDTH (FITS 36" OPENING) 35 1/4"
 DEPTH WITHOUT DOOR 29 1/2"
 DEPTH TO DOOR HANDLE 36 1/2"
 HEIGHT WITHOUT HINGE 68 1/2"
 DEPTH WITHOUT HANDLE 34 1/2"
 HEIGHT WITH HINGE 70"
 TOP OF REFRIGERATOR WITH DOOR OPEN 90°
 DEPTH WITH DOOR OPEN 90° 44"
 DEPTH WITH DOOR OPEN 90° 44"
 DEPTH WITH DRAWER OPEN 45 1/2"
 TOP OF REFRIGERATOR WITH DOORS OPEN 125°
 12 1/2"
 125°
 125°
 61 1/2"

Standard-Depth Refrigerator
 Standard-depth refrigerators typically measure 30 to 35 inches in depth, as opposed to counter-depth refrigerators that sit flush with cabinetry.

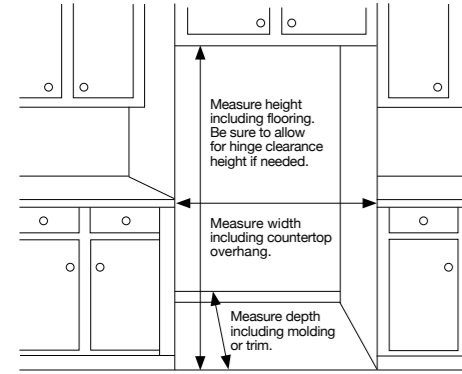

Installation clearances

- ✓ Allow 3 3/4" of clearance when installing along a wall. This will allow for the door to open 90 degrees without the handle contacting the wall.
- ✓ Allow 2" minimum clearance at rear for proper air circulation and water/electrical connections.
- ✓ Allow a 3/8" minimum clearance at sides and top for ease of installation.

For optimal usage and ability to open refrigerator doors completely, do not install next to a wall.

Please note: The above dimensions and cutout information is for planning purposes only. For complete installation details, consult manual packed with product or download manual online at samsung.com.

Walk the delivery route

- ✓ Identify the narrowest opening that the appliance will travel through, from outside the home to the location where it will be installed.
- ✓ Appliance depth or width must be smaller than the width of the narrowest opening.

Will It Fit? Guide

Energy Guide and User Manual

U.S. Government Federal law prohibits removal of this label before consumer purchase.

ENERGYGUIDE

Refrigerator-Freezer

- Automatic Defrost
- Bottom-Mounted Freezer
- Through-the-Door Ice Service

Samsung
Model RF32CG5400**
Capacity: 30.5 Cubic Feet

Compare ONLY to other labels with yellow numbers.
Labels with yellow numbers are based on the same test procedures.

Estimated Yearly Energy Cost
\$110

Cost Ranges	Models with similar features	\$90	\$113
	All models	\$84	\$124

785 kWh
Estimated Yearly Electricity Use

- Your cost will depend on your utility rates and use.
- Both cost ranges based on models of similar size capacity.
- Models with similar features have automatic defrost, bottom-mounted freezer and through-the-door ice.
- Estimated energy cost based on a national average electricity cost of 14 cents per kWh.

ftc.gov/energy



Energy Guide



Refrigerator

User manual

RF32CG*****/RF27CG*****

Free Standing Appliance

SAMSUNG

User Manual

Warranty

LIMITED WARRANTY (U.S.A.)

SAMSUNG REFRIGERATOR

LIMITED WARRANTY TO ORIGINAL CONSUMER PURCHASER WITH PROOF OF PURCHASE

This SAMSUNG brand product, as supplied and distributed by Samsung Electronics America, Inc. (SAMSUNG) and delivered new, in the original carton to the original consumer purchaser, is warranted by SAMSUNG against manufacturing defects in materials or workmanship for the limited warranty period of:

One (1) year parts and labor

Five (5) years parts and labor on Sealed Refrigeration System Only (Compressor, Evaporator, Condenser, Drier, and Connecting Tubing)

Ten (10) years part and Five (5) years labor on Digital Inverter Compressor Only

This limited warranty is valid only on products purchased and used in the United States that have been installed, operated, and maintained according to the instructions attached to or furnished with the product. To receive warranty service, the purchaser must contact SAMSUNG at the address or phone number provided below for problem determination and service procedures. Warranty service can only be performed by a SAMSUNG authorized service center. The original dated bill of sale must be presented upon request as proof of purchase to SAMSUNG or SAMSUNG's authorized service center to receive warranty service.

SAMSUNG will provide in-home service within the contiguous United States during the warranty period at no charge, subject to availability of SAMSUNG authorized servicers within the customer's geographic area. If in-home service is not available, SAMSUNG may elect, at its option, to provide transportation of the product to and from an authorized service center. If the product is located in an area where service by a SAMSUNG authorized servicer is not available, you may be responsible for a trip charge or required to bring the product to a SAMSUNG authorized service center for service.

To receive in-home service, product must be unobstructed and accessible to the service agent.

During the applicable warranty period, a product will be repaired, replaced, or the purchase price refunded, at the sole option of SAMSUNG. SAMSUNG may use new or reconditioned parts in repairing a product, or replace the product with a new or reconditioned product. Replacement parts and products are warranted for the remaining portion of the original product's warranty or ninety (90) days, whichever is longer. All replaced parts and products are the property of SAMSUNG and you must return them to SAMSUNG.

This limited warranty covers manufacturing defects in materials or workmanship encountered in normal household, noncommercial use of this product and shall not cover the following: damage that occurs in shipment, delivery, installation, and uses for which this product was not intended; damage caused by unauthorized modification or alteration of the product; product where the original factory serial numbers have been

Feature Icons

**RF32CG5400 – 31 cu. ft. Mega Capacity 3-Door
French Door Refrigerator with Four Types of Ice**

Feature Icons

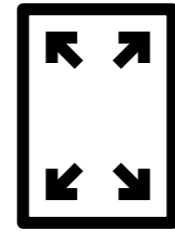

Mega Capacity

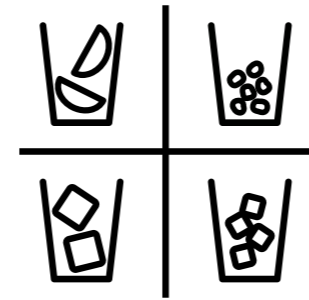

Four Types of Ice

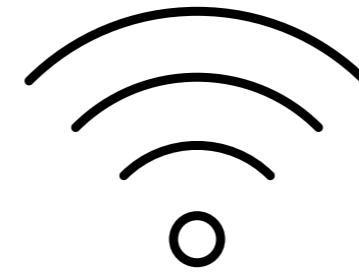

Wi-Fi Connectivity



10-Year Compressor Warranty*

*10 years of warranty coverage on the compressor.

SAMSUNG