

DINAMICA plus



QUICK START GUIDE

De'Longhi

VISIT US AT [DELONGHI.COM](https://www.delonghi.com)



ECAM37095TI



EASILY REGISTER YOUR MACHINE & GET MORE OUT OF YOUR ESPRESSO EXPERIENCE

Register your Fully Automatic Espresso Machine and become De'Longhi Club Member. Join the De'Longhi Club to get more out of your coffee experience.



RECEIVE 1
ADDITIONAL YEAR
OF WARRANTY
FOR REGISTERING
PRODUCT



MEMBERSHIP
DISCOUNT ON
ACCESSORIES



PRIVATE
ONLINE SALES



DE LONGHI
SPECIALIST
SUPPORT



EASY
ORDERING



EXCLUSIVE
COFFEE EVENTS
& NEWS

De'Longhi Club Member discount: Only members of the Club will receive special offers on coffee accessories.

STEP #1: TAKE A PHOTO

- Snap a photo of the camera icon, including the points.

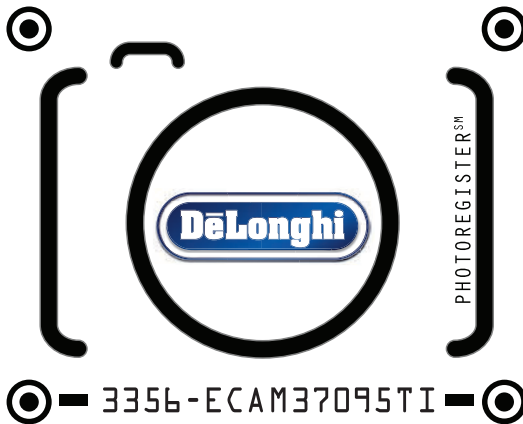

STEP #2: SEND PHOTO

- Send a photo via text, Facebook Messenger or upload online.



TEXT PHOTO
TO 71403



MESSANGER @
PHOTOREGISTER



ONLINE:
WWW.DELONGHI.PHOTO

NEED HELP?:

Visit photoregister.com/help
or text HELP to 71403.

CONTACT US

- Call 1-800-945-0929
- Online: Delonghi.com

IN THE BOX

- A1. Beans container lid
- A2. Pre-ground coffee funnel lid
- A3. Bean container
- A4. Pre-ground coffee funnel
- A5. Grinding adjustment dial
- A8. Hot water and steam connection nozzle
- A9. Coffee spouts (adjustable height)
- A10. Condensate tray
- A11. Coffee grounds container
- A15. Drip tray
- A17. Water tank
- A20. Infuser
- A22. Main switch
- B-C. Display Panel
- D2. Pre-ground coffee measuring scoop
- D3. Milk container
- D6. Hot water spout



Get Started &
Owner's Instructions
Booklets

This short guide is not intended to explain all the functions of the appliance. Please read all the owner's instruction booklet before use.

ECAM37095TI



- B1. Bluetooth active symbol
- B2. Energy Saving active symbol
- B3. Selected strength
- B4. Directly selected beverages
- B5. Scroll arrow
- B6. Quantity selected
- B7. Descale required alarm
- B8. Milk container needs cleaning alarm
- B9. Filter needs replacing alarm
- C1. Beverage quantity selection
- C2. Profile selection

- C3. Settings menu
- C4. Exit from the selected function and go back to the main menu
- C5. My beverages selection menu. Unless previously programmed from the settings menu as described in chapter "12. Customizing the beverages", the beverage is programmed directly the first time you use the appliance
- C6. Beverage strength selection

GET READY

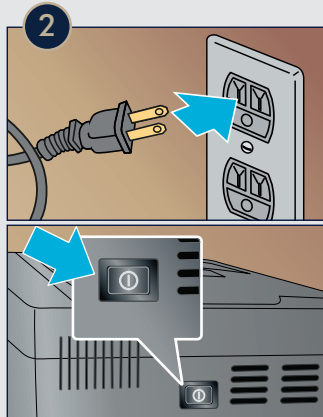

Download the De'Longhi Coffee Link App. Connect via Bluetooth to your machine to access many functions and settings remotely.

Remove all stickers and clean all accessories with warm water and mild detergent and dry them. Follow the instructions on the display of the machine. Priming the machine is only required the first time out of the box.

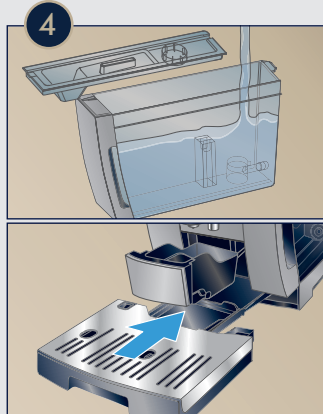
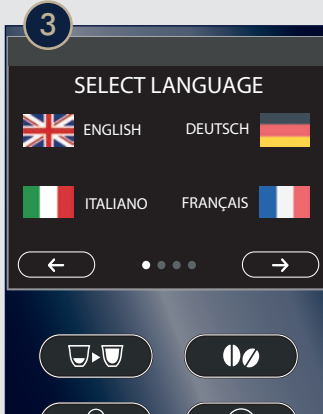

6 The machine will deliver hot water and will shut off automatically once rinsing is complete.

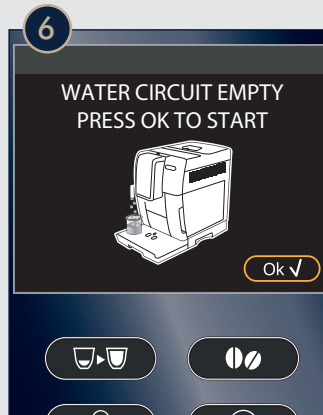
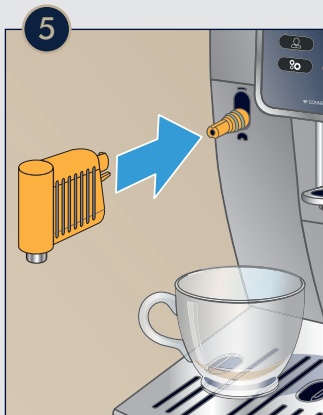

BREW ESPRESSO

The first time using the machine, brew and dump the first 3-4 espressos. If you haven't been using the machine for 3-4 days, perform a rinsing cycle (⚙️ setting menu → 🔄 rinsing) before brewing.

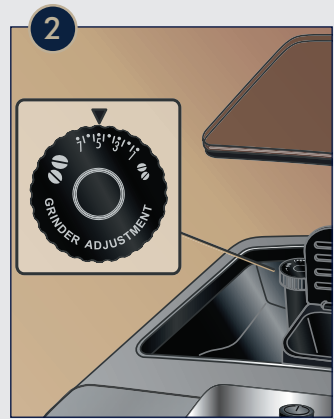
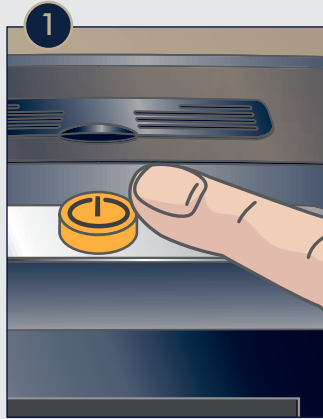

2 To brew the perfect espresso set your grinder following the “Extraction Guidelines” on page 9.

5 Select one of the recipes on the touch screen. Preparation will start with default strength and quantity, which can be changed by customizing your recipes.

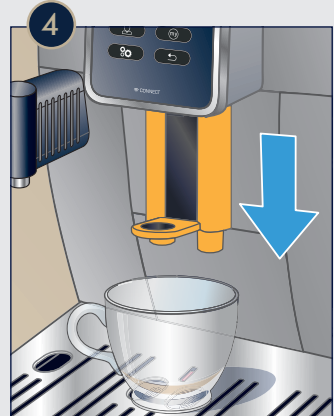

MILK RECIPIES

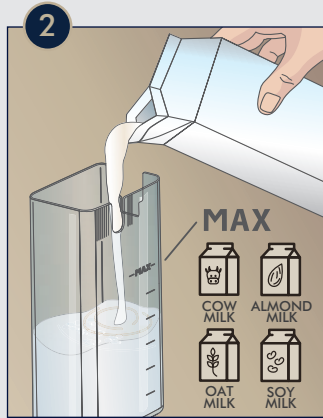
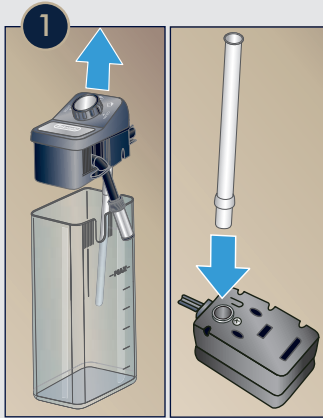

To make a Milk recipe, use the provided milk container. Use cold cow milk or your preferred milk alternative. Whole milk or oat milk will give the best results.

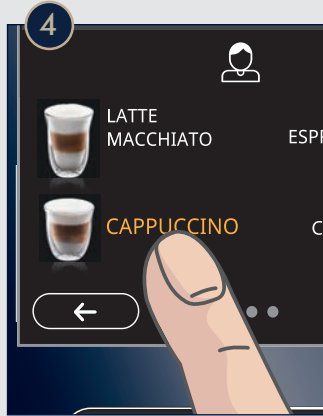
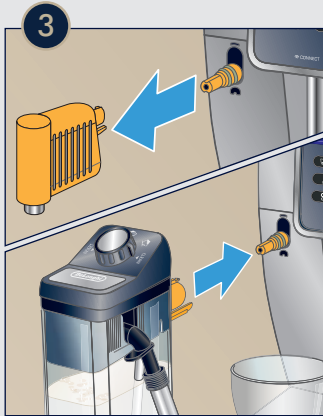

1 Open the lid and make sure the milk intake tube is correctly inserted in the bottom of the milk container lid.

4 Select a milk based recipe.

5 Use the selector to choose between flatter or dryer foam. On the screen, the machine will suggest what to select based on your chosen recipe.



6 Once finished, twist the selector to "clean" position to perform a rinsing of the milk container lid. If you prepare multiple milk recipes, you should do this only after you finished your last recipe. Store the remaining milk in the container in the fridge.



CUSTOMIZE RECIPES

Temporary Personalization:

Temporarily personalize the volume  and strength  of recipes.



Advanced Personalization:

Save and access up to 3 different profiles  and personalize and save recipes with the  function.



Pre-ground:

To use pre-ground coffee, press the strength selector until the icon  shows on the screen and add one measuring scoop of pre-ground coffee in the dedicated funnel.



EXTRACTION GUIDELINES

Depending on your choice of beans, you might need to adjust the grinder setting to a finer or more coarse choice.



- Flow like warm honey
- Nut-brown Crema
- Well balanced and lingering taste



- Flowing fast like water
- Light and pale Crema

To make it perfect:

- Adjust grinding setting to a finer setting
- Select a higher strength

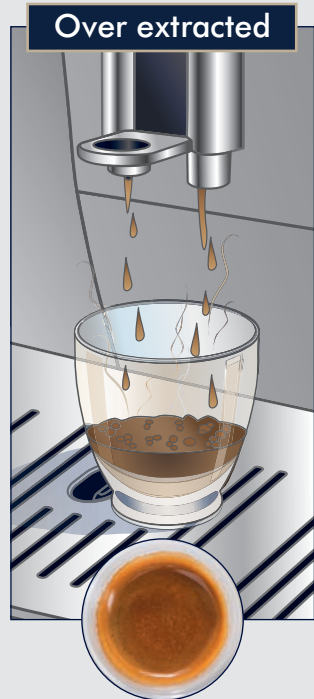

- Flowing in drips or not at all
- Crema very dark and not uniform

To make it perfect:

- Adjust grinding setting to a coarser setting
- Select a lower strength



CLEANING

Keeping your machine clean will improve quality of the beverage and life span of the machine.

1 Empty drip tray daily and empty coffee ground container when lights come up.

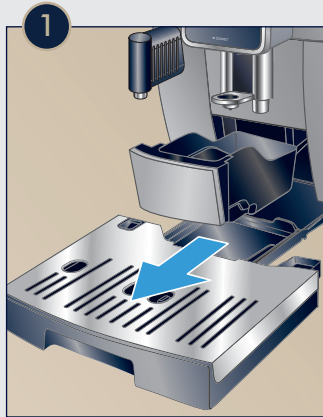

2 Once a month, clean the inside of the machine. Follow User Manual detailed instruction section 14.9.



3 Remove and clean each part of the milk container lid. Follow User Manual section 14.10.

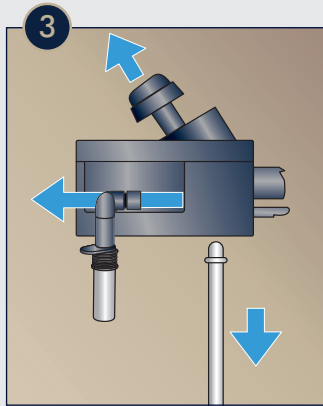

DESCALING

4 Promptly descale when indication light comes on. Follow user Manual section 15.



INSERT WATER FILTER

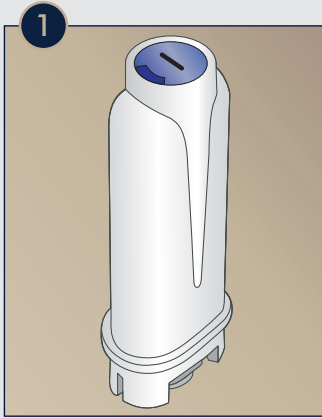

To ensure better quality of the water install the provided water filter. Under normal use, filters last about 3 months. If coffee maker is left unused, the filter will last a maximum of 3 weeks*.

You can purchase extra filters on www.delonghi.com

*The type of filter may vary.

2 From the Settings menu, select Water filter and follow the step by step instructions on the screen.

3 Be ready with a large container (17 fl oz min), to collect the water that will be delivered from the water spout during the installation process.

SET WATER HARDNESS

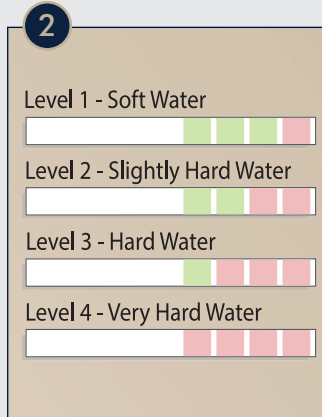

Analyze the hardness of your water to set your machine accordingly.

1 Dip the provided Total Hardness Indicator in a glass of water for one second and shake it.

2 Wait a couple of minutes. Read the Indicator paper colors and compare with this table.

3 Set water hardness on the machine from Setting Menu → Water Hardness. Follow instructions on the screen.

