

# SAMSUNG

# Product Guide

## 30" Single Wall Oven with Steam Cook

NV51CG600S

Available in:  
Stainless Steel  
Matte Black Steel



# Table of Contents

## NV51CG600S - 30" Single Wall Oven with Steam Cook

### Product Overview

Product Overview	4
Carousel Image Order	5

### Product Messaging

Features and Benefits	7
Product Videos	10
Lifestyle Images	11
Fact Tag Guidance	12

### Product Specs

Spec Sheet	14
User and Install Manuals	15

### Feature Icons

17

# Product Overview

---

NV51CG600S – 30" Single Wall Oven with Steam Cook

# Product Overview

## Product Title

30" Single Wall Oven with Steam Cook

## Product Description (Paragraph)

Samsung 30" Single Wall Ovens feature stunning stainless steel finishes that blend seamlessly with the décor of your kitchen. Rich with features like Steam Cook, Air Sous Vide, and Air Fry, you'll enjoy cooking just like a professional in your own kitchen.

## Short Product Description (bullets)

- The Samsung 30" Single Wall Oven with Steam Cook features stunning stainless steel finishes that blend seamlessly with the décor of your kitchen.
- Rich with features like Steam Cook, Air Sous Vide, and Air Fry, you'll enjoy cooking just like a professional in your own kitchen.

## Easy Ads Links

**Stainless Steel:** <https://dam.gettyimages.com/p/z0c3461/digital-appliances?o=AND&q=NV51CG600SSR>

**Matte Black Steel:** <https://dam.gettyimages.com/p/z0c3461/digital-appliances?o=AND&q=NV51CG600SMT>

## Available Colors



**Stainless Steel**  
NV51CG600SSR

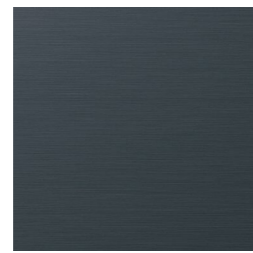

**Matte Black Steel**  
NV51CG600SMT



# Carousel Image Order

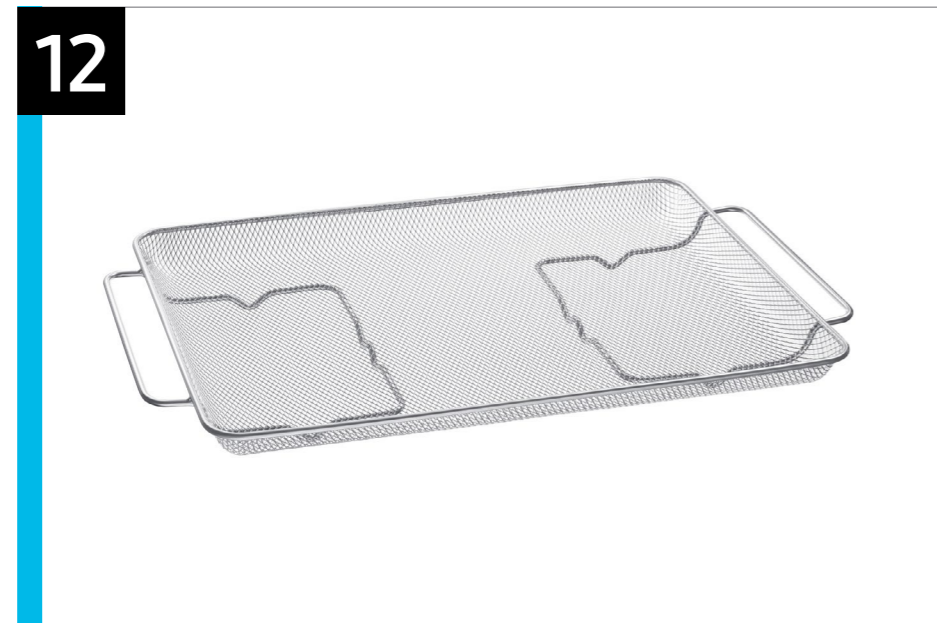



# Product Messaging

---

**NV51CG600S – 30" Single Wall Oven with Steam Cook**

## Features and Benefits – NV51CG600S

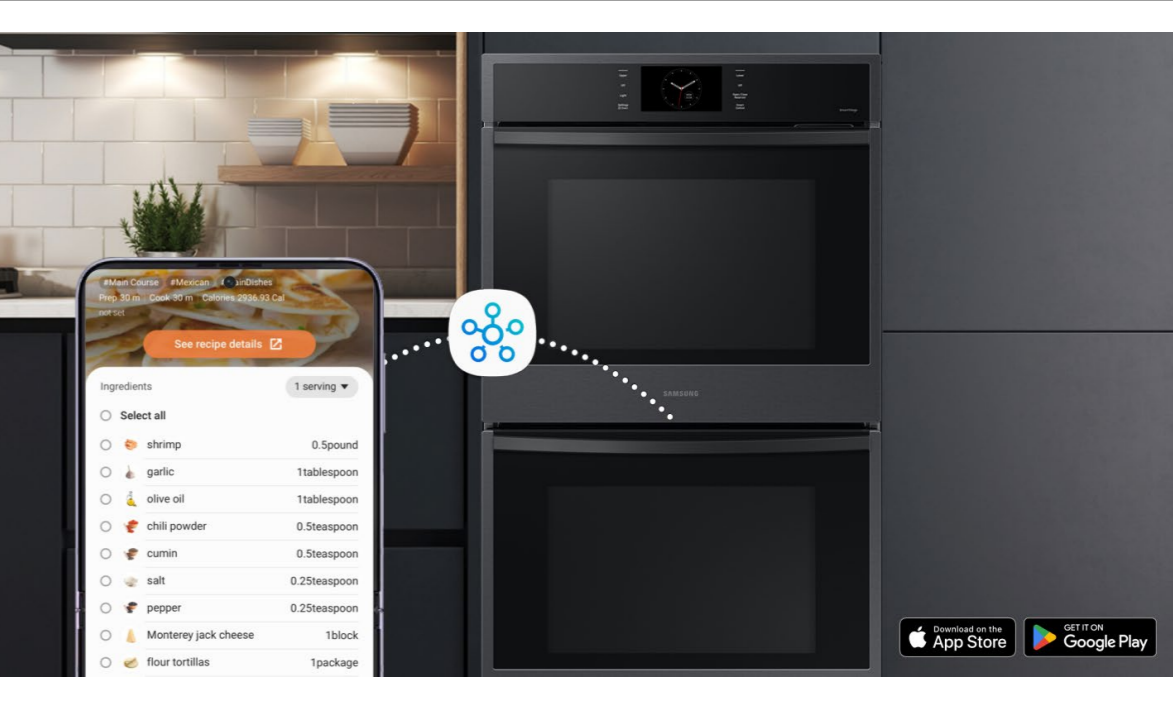
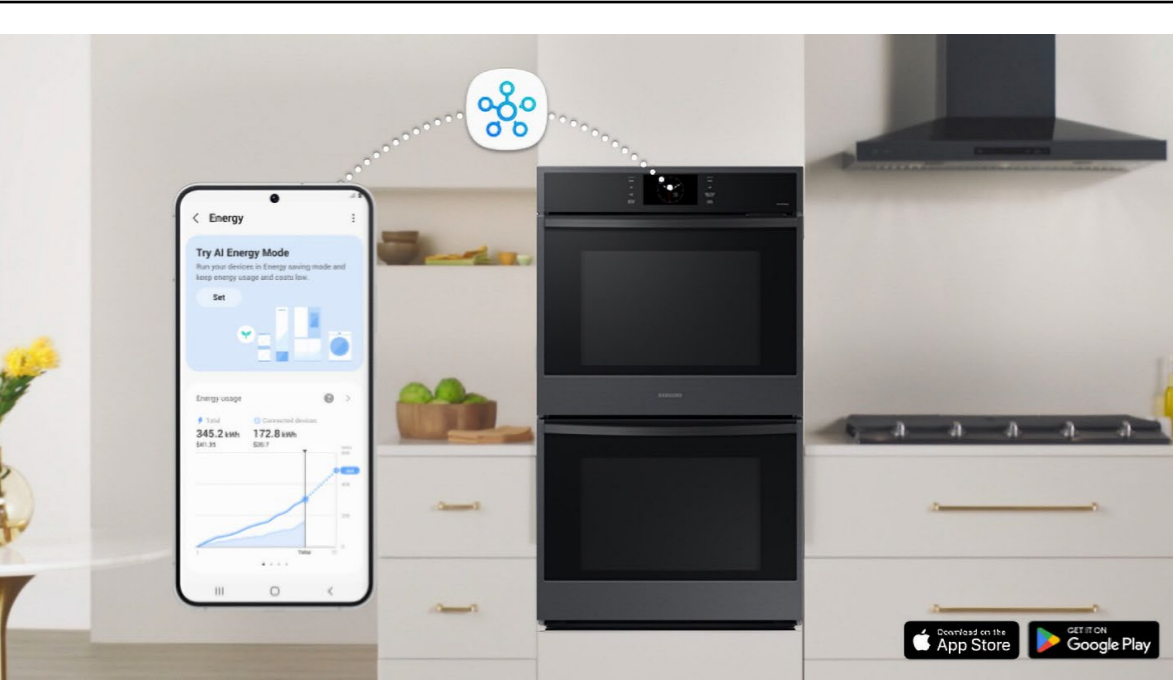

Overall Product Headline	Feature Name	Long Body Copy	Short Body Copy	Associated Image
<p><b>Moist and flavorful foods</b></p>	<p><b>Steam Cook</b></p>	<p>An easy-fill water tray lets you bake, broil, and roast with added steam, resulting in foods that are moist and flavorful.</p>	<p>Bake, broil, and roast with added steam, resulting in foods that are moist and flavorful.</p>	
<p><b>Say goodbye to dry</b></p>	<p><b>Air Sous Vide</b></p>	<p>Preserve your food’s natural flavor &amp; avoid overcooking. Precise, controlled heat and airflow within the oven gives you sous vide results without the water bath.* Perfect for fish, poultry, and vegetables.</p> <p><small>* Requires a sous vide cooking bag, which is not included with the oven.</small></p>	<p>Preserve your food’s natural flavor &amp; avoid overcooking using air sous vide.*</p> <p><small>* Requires a sous vide cooking bag, which is not included with the oven.</small></p>	
<p><b>Cooking with a crunch, now healthier*</b></p> <p><small>*As compared to deep frying.</small></p>	<p><b>No-preheat Air Fry</b></p>	<p>Enjoy healthier* fried foods fast without storing another small appliance in your kitchen, by using Air Fry mode, built right into your oven. Air Fry tray included.</p> <p><small>*As compared to deep frying.</small></p>	<p>Enjoy healthier* fried foods fast by using Air Fry, built right into your oven. Air Fry tray included.</p> <p><small>*As compared to deep frying.</small></p>	

## Features and Benefits – NV51CG600S (Continued)

Overall Product Headline	Feature Name	Long Body Copy	Short Body Copy	Associated Image
<p><b>Nutritious and delicious vegetables</b></p>	<p><b>Convection Vegetable</b></p>	<p>Quickly cook crispy vegetables, no preheating needed.</p>	<p>Quickly cook crispy vegetables.</p>	
<p><b>Preheat and plan meals on the go</b></p>	<p><b>SmartThings App</b></p>	<p>The SmartThings App lets you search recipes, plan meals, and pre-heat your oven from your smartphone.*</p> <p><small>*Available on Android and iOS devices. A Wi-Fi connection and a Samsung account are required.</small></p>	<p>The SmartThings App lets you search recipes, plan meals, and pre-heat your oven from your smartphone.*</p> <p><small>*Available on Android and iOS devices. A Wi-Fi connection and a Samsung account are required.</small></p>	
<p><b>Monitor and control energy usage</b></p>	<p><b>SmartThings Energy®</b></p>	<p>SmartThings Energy® lets you monitor and manage your wall oven's power usage. Get energy saving tips and alerts to help lower your electric bill.*</p> <p><small>*Available on Android and iOS devices. A Wi-Fi connection and a Samsung account are required.</small></p>	<p>SmartThings Energy® lets you monitor and manage your wall oven's power usage.</p> <p><small>*Available on Android and iOS devices. A Wi-Fi connection and a Samsung account are required.</small></p>	

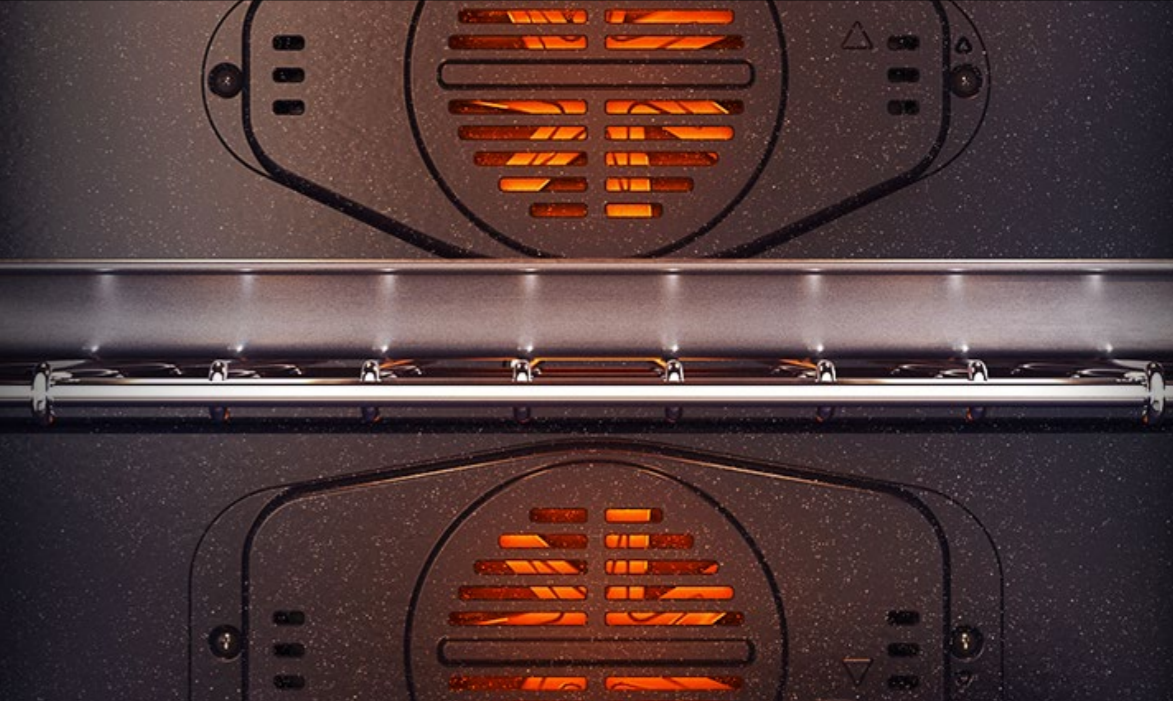

## Features and Benefits – NV51CG600S (Continued)

Overall Product Headline	Feature Name	Long Body Copy	Short Body Copy	Associated Image
<p><b>Easy to monitor and control</b></p>	<p><b>7" LCD screen</b></p>	<p>Make cooking easy with a control panel that has a large 7" LCD display. It's easy to read with large text and icons so you can easily adjust settings and monitor your cooking progress, even from a distance.</p>	<p>The large 7" LCD display is easy to read, so you can adjust settings and monitor your cooking progress, even from a distance.</p>	
<p><b>Fast cooking</b></p>	<p><b>Dual Convection</b></p>	<p>Save time and cook food more evenly with dual convection. Great for baking, roasting, and broiling, the dual convection system has two heated fans that distribute heat throughout the oven and keep temperature constant everywhere.</p>	<p>Great for baking, roasting, and broiling, the dual convection system has two heated fans that distribute heat throughout the oven and keep temperature constant everywhere.</p>	
<p><b>Does the hard work for you</b></p>	<p><b>Self and Steam Clean</b></p>	<p>Get help from your oven with Self Clean. The self-cleaning system deep cleans by heating to a high temperature to burn off grease and food residue. Steam Clean in 20 minutes for easier cleaning jobs.</p>	<p>Get help from your oven with Self and Steam Clean.</p>	

# Product Videos

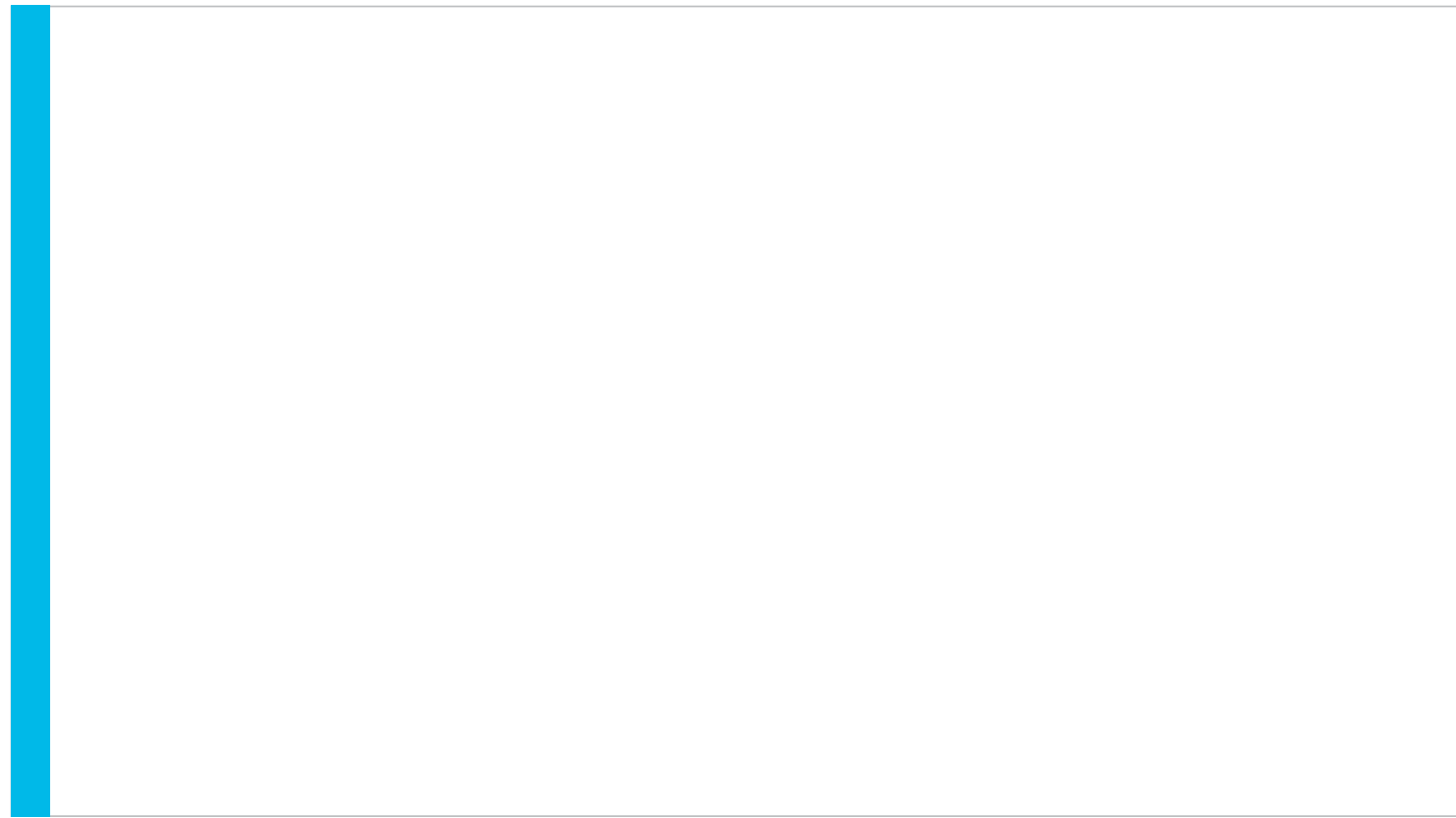
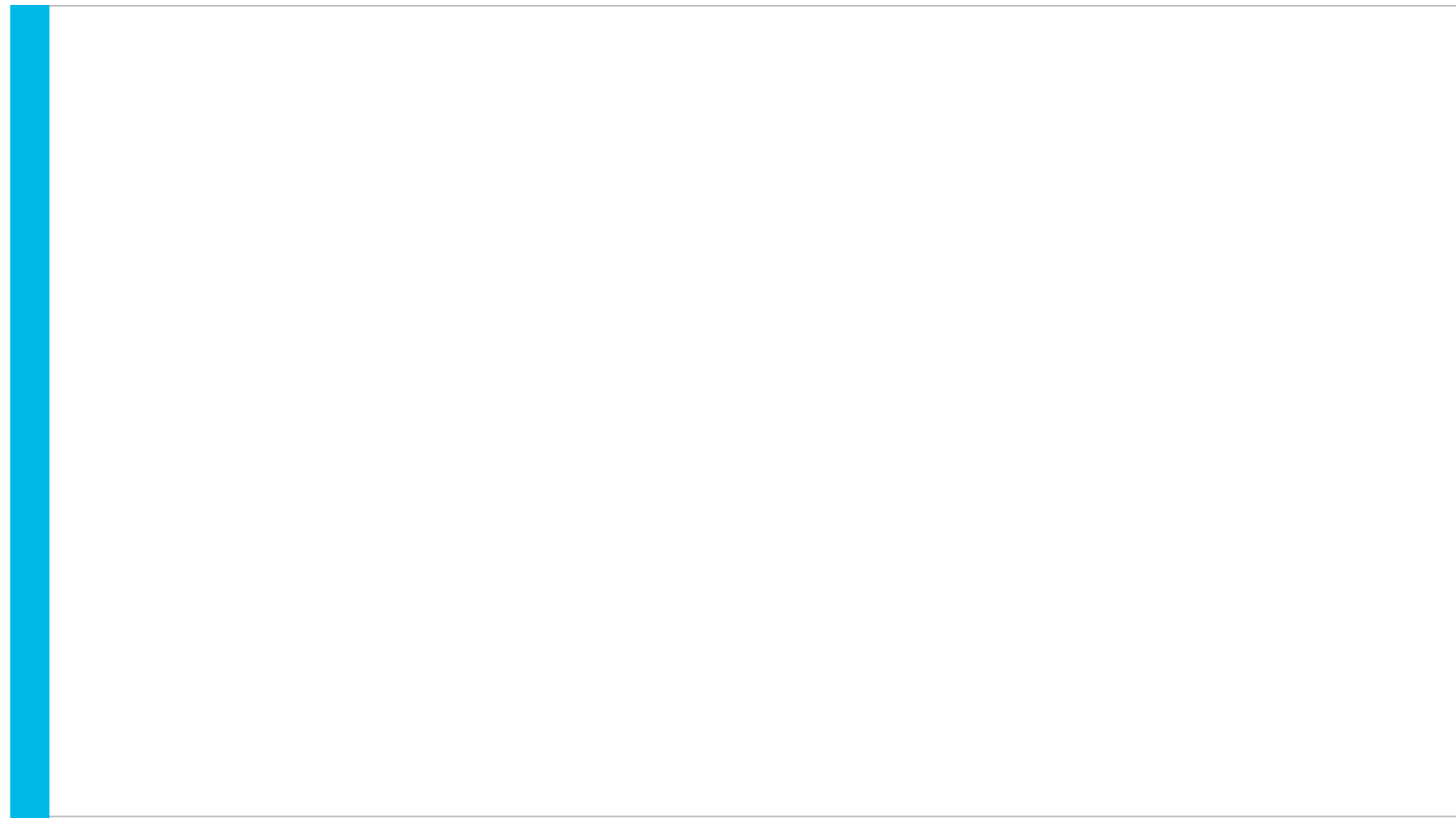
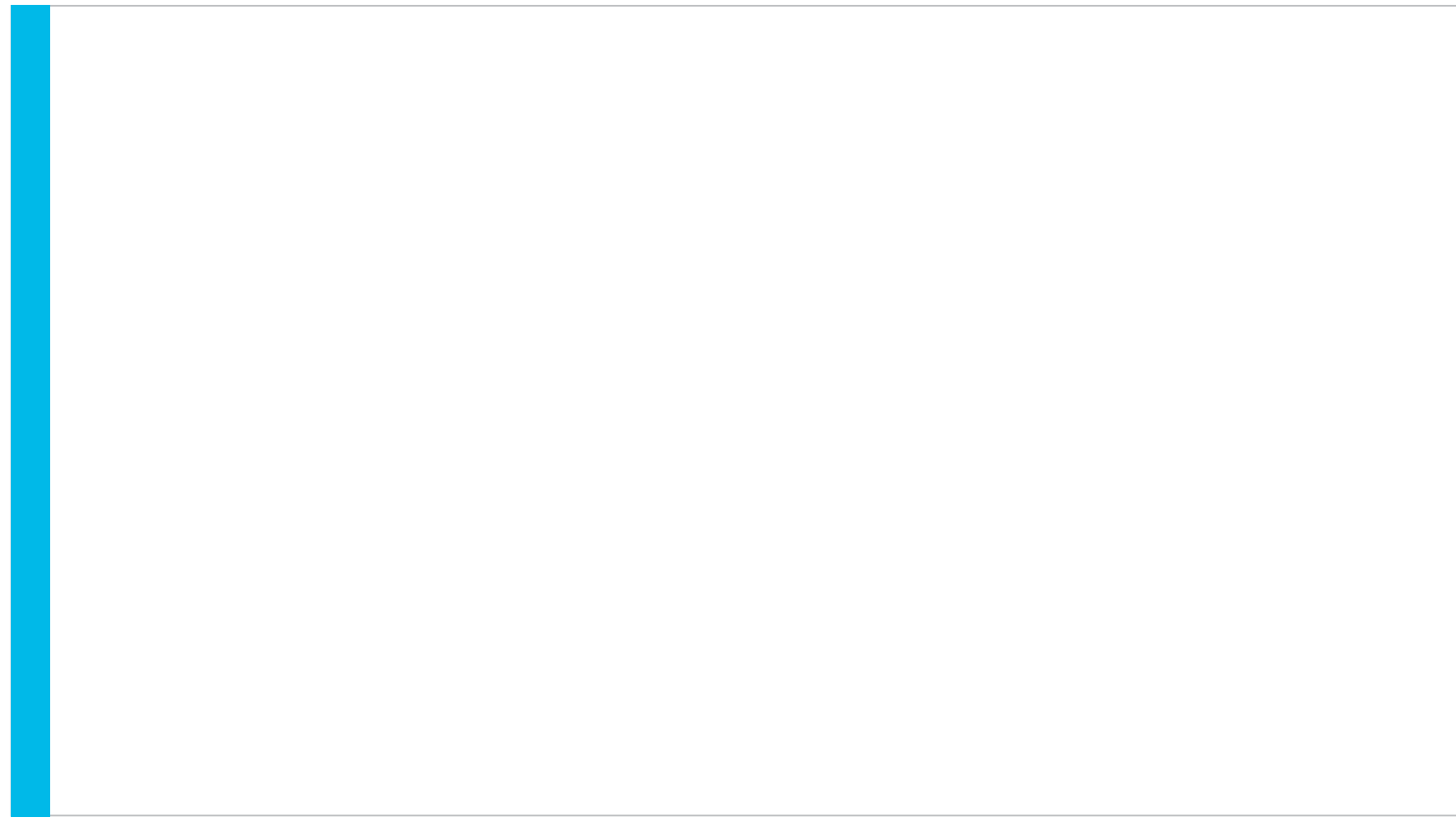

# Primary Lifestyle Images

For use on marketing landing pages , category pages and offsite landing pages.



Stainless Steel



Matte Black Steel

# Fact Tag Guidance

Please follow one of the below naming conventions for fact tags at retail, accounting for any potential character count limitations. Please also ensure that any feature list appearing on fact tags follows the Product Messaging hierarchy and copy noted in the Product Guide for each model.

## **NV51CG600S Long (More than 50 Characters)**

30" Single Wall Oven with Steam Cook

## **Medium (50 Characters or less)**

30" Single Wall Oven

## **Short (35 Characters or less)**

Single Wall Oven

# Product Specs

---

**NV51CG600S – 30" Single Wall Oven with Steam Cook**

# Spec Sheet

## NV51CG600S

30" Single Wall Oven

**SAMSUNG**



**Available Colors**

- Stainless Steel**  
NV51CG600SSR
- Matte Black**  
NV51CG600SMT

**Design**

- Drop-Down Door Design
- Transitional Design

**Features**

- Steam Cook
- Air Sous Vide
- Air Fry, Tray Included
- Convection Vegetable
- Wi-Fi Connectivity
- Dual Convection
- Digital Touch Controls
- 7-inch LCD Display
- Steam Clean & Self-Clean
- Halogen Lights
- 2 Heavy-Duty Racks
- Gliding Rack
- Broil Element
- 6 Rack Positions

**Convenience**

- Sabbath Mode
- Delay Start
- Child Safety Lock
- Warming Mode
- Kitchen Timer

**Dimensions**

**Product Dimensions & Weight (WxHxD)**  
**Outside (Max) Wall Oven Dimensions:**  
 29 1/4" x 28 3/16" x 24 1/8"  
**Wall Oven Cut-Out Dimensions:**  
 28 1/2" x 27 1/4" x 23 1/2"  
 Weight: 167.6 lbs

**Shipping Dimensions & Weight (WxHxD)**  
 Dimensions: 33 1/16" x 33 1/16" x 29 13/16"  
 Weight: 189.6 lbs

**Warranty**

One (1) Year All Parts and Labor

**UPC**

Single Wall Oven	Model #	UPC Code
Stainless Steel	NV51CG600SSR	887276757681
Matte Black	NV51CG600SMT	887276757674



Spec Sheet - front

## NV51CG600S

30" Single Wall Oven

**SAMSUNG**

**Product Dimensions**

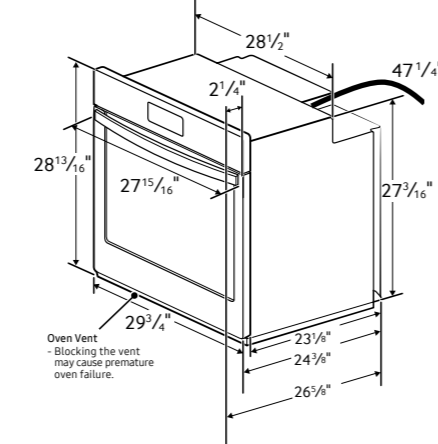

**Electrical Requirements**

KW RATING	
240V	4.9 kW
208V	3.7 kW
BREAKER SIZE	
240V	30 Amps
208V	20 Amps

**Cabinet Dimensions**

Single Oven Installed in Cabinet  
 \* Junction Box.  
 \*\* Allow a minimum of 22" for clearance to adjacent corners, drawers, walls, etc. when door is open.

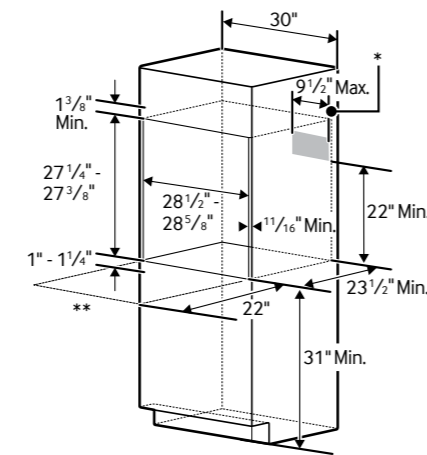

Actual color may vary. Design, specifications, and color availability are subject to change without notice. Non-metric weights and measurements are approximate.  
 ©2023 Samsung Electronics America, Inc. 85 Challenger Road, Ridgefield Park, NJ 07660. Tel: 800-SAMSUNG, samsung.com. Samsung is a registered trademark of Samsung Electronics Co. Ltd.

Spec Sheet - back

# User and Install Manuals

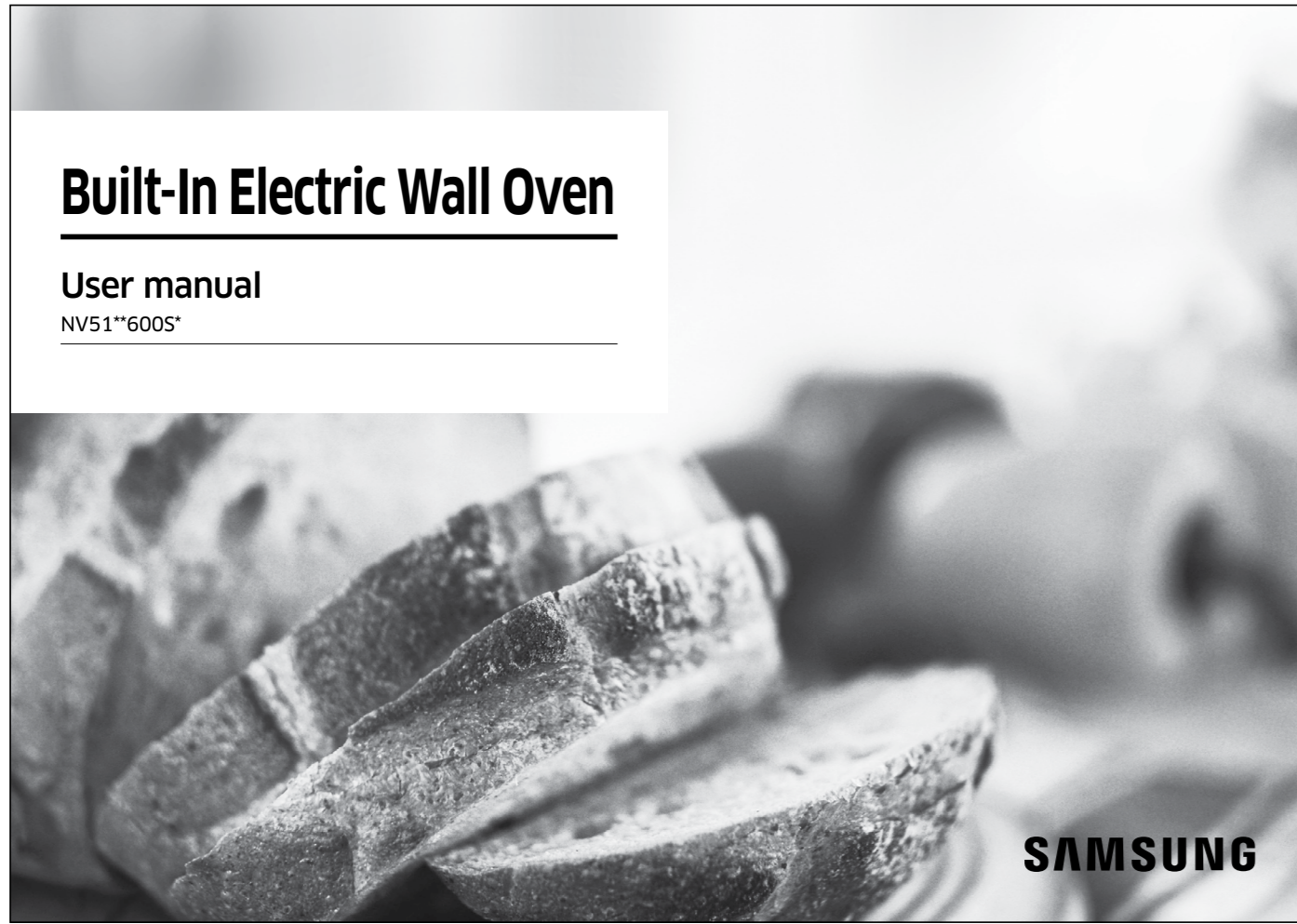

User Manual

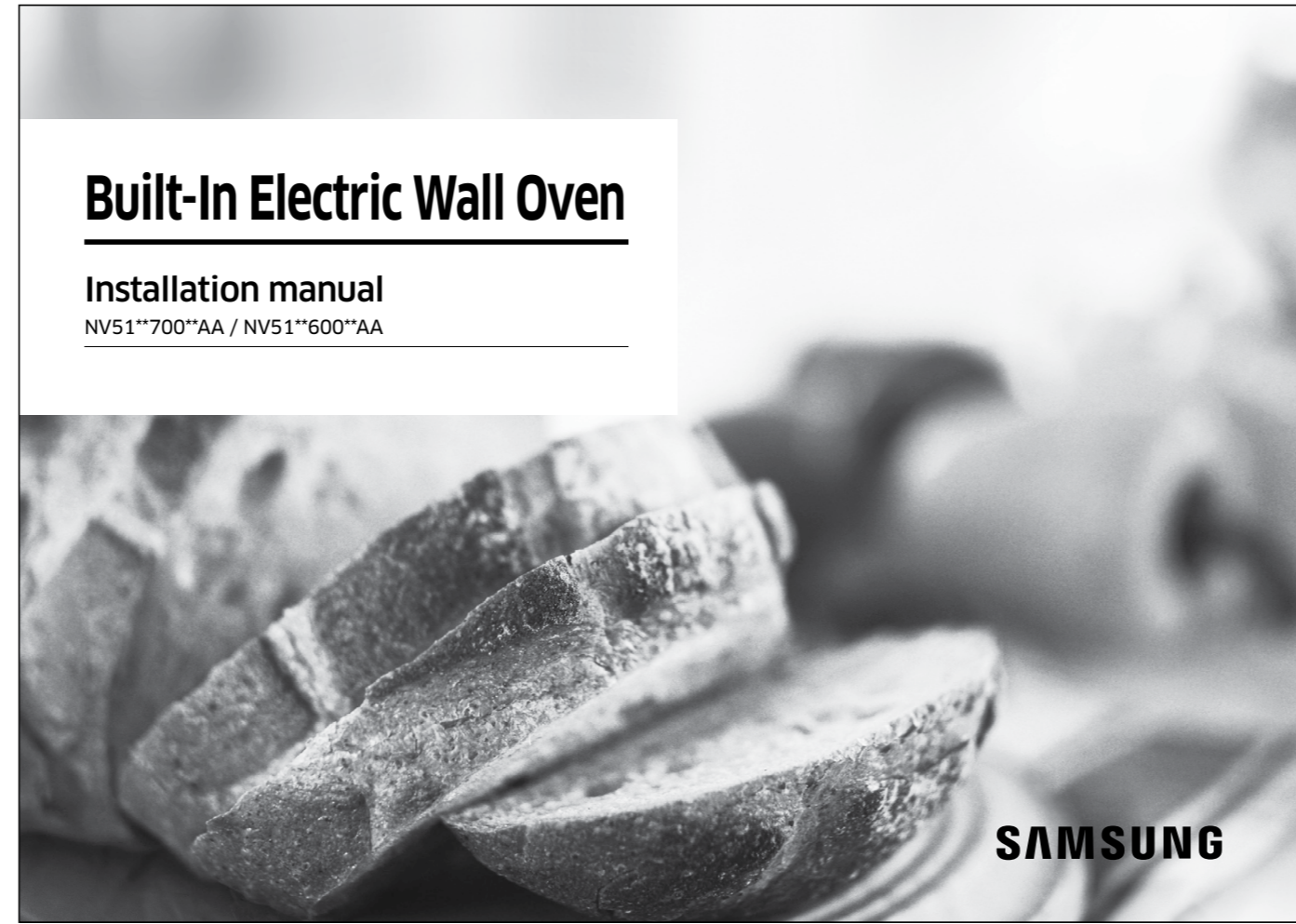

Install Manual

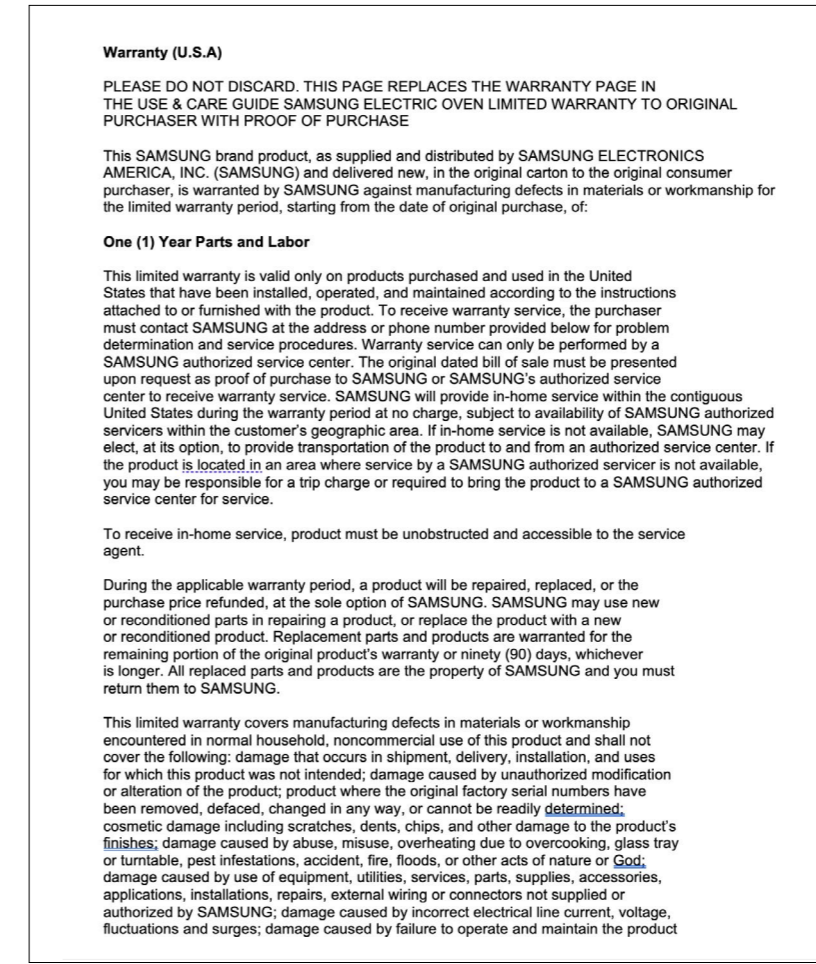

Manufacturer Warranty

# Feature Icons

---

NV51CG600S – 30" Single Wall Oven with Steam Cook



# Feature Icons



Air Fry

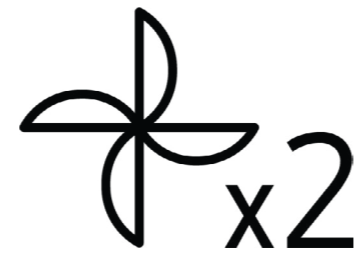

Dual Convection  
Oven



Wi-Fi Connectivity



Self + Steam Clean

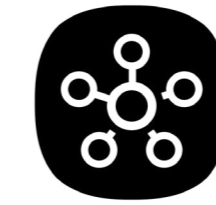

SmartThings

**SAMSUNG**