

What to Expect with Your Installation

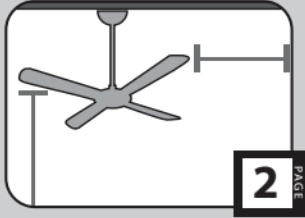

Preparation

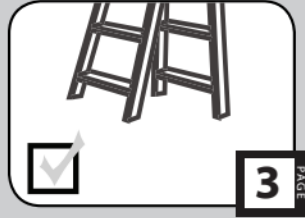

Ceiling Plate

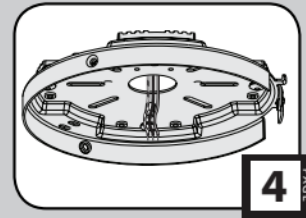

Hanging the Fan

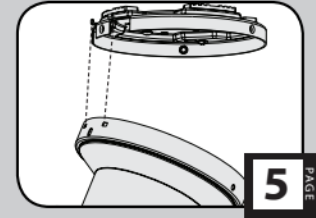

Wiring

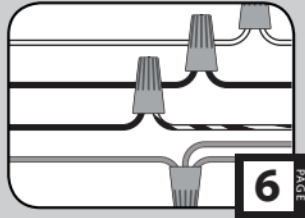

Canopy

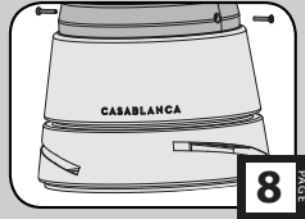

Blade

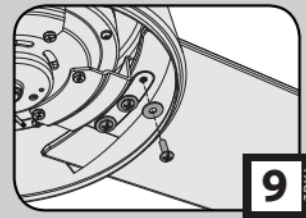

Switch Housing

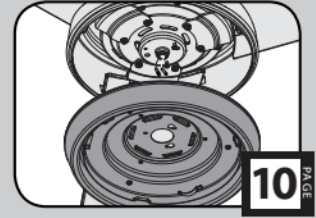

Light Kit

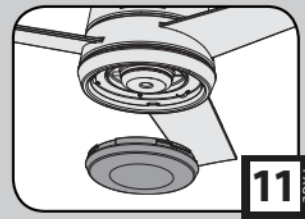

Wall Control

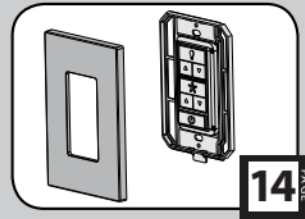

Maintenance & Cleaning

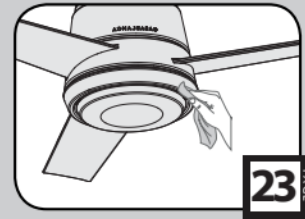

Troubleshooting

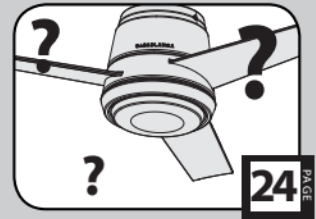

What to Expect with Your Installation

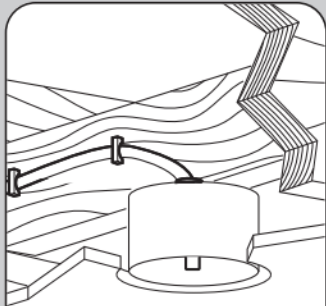

Must be able to secure the fan to building structure or fan-rated outlet box



If you are unfamiliar with wiring, use a qualified electrician.



Know your wiring

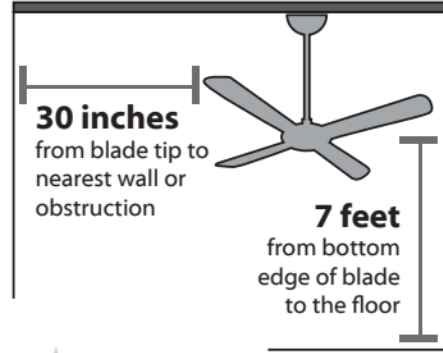

Assess location

You may need a friend to help you.



Check box to see fan weight

Read and Save These Instructions

This product conforms to UL Standard 507.

⚠ WARNINGS



- w.1 - To reduce the risk of fire, electrical shock, or personal injury, mount fan directly from building structure and/or an outlet box marked acceptable for fan support of 70 lbs (31.8 kg) and use the mounting screws provided with the outlet box.
- w.2 - To avoid possible electrical shock, before installing or servicing your fan, disconnect the power by turning off the circuit breakers to the outlet box and associated wall switch location. If you cannot lock the circuit breakers in the off position, securely fasten a prominent warning device, such as a tag, to the service panel.
- w.3 - To reduce the risk of electric shock, this fan must be installed with an isolating wall control/switch.
- w.4 - To reduce the risk of personal injury, do not bend the blade brackets when installing the blade brackets, balancing the blades, or cleaning the fan. Do not insert foreign objects in between rotating fan blades.

⚠ CAUTIONS

- c.1 - All wiring must be in accordance with national and local electrical codes ANSI/NFPA 70. If you are unfamiliar with wiring, use a qualified electrician.
- c.2 - Use only Casablanca replacement parts.

This equipment has been tested and found to comply with the limits for a Class B digital device, pursuant to part 15 of the FCC Rules. These limits are designed to provide reasonable protection against harmful interference in a residential installation. This equipment generates, uses and can radiate radio frequency energy and if not installed and used in accordance with the instructions may cause harmful interference to radio communications.

However, there is no guarantee that interference will not occur in a particular installation. If this equipment does cause harmful interference to radio or television reception, which can be determined by turning the equipment off and on, the user is encouraged to try to correct the interference by one or more of the following measures:

- Reorient or relocate the receiving antenna.
- Increase the separation between the equipment and receiver.
- Connect the equipment into an outlet on a circuit different from that to which the receiver is connected.
- Consult the dealer or an experienced radio/TV technician for help.

Caution: modifications not approved by the party responsible for compliance could void user's authority to operate the equipment.

This device complies with Part 15 of the FCC Rules. Operation is subject to the following two conditions: (1) This device may not cause harmful interference, and (2) this device must accept any interference received, including interference that may cause undesired operation.

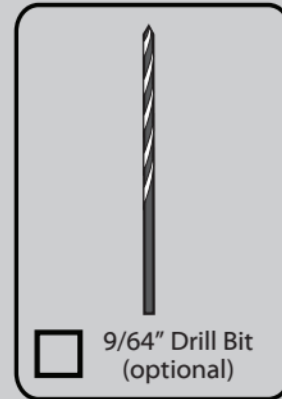
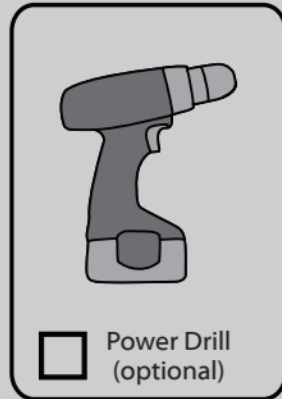
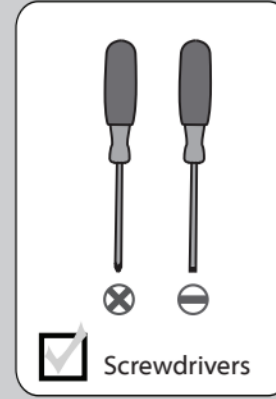
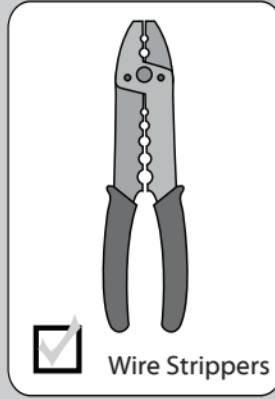

If mounting to a support structure, you will also need these tools.

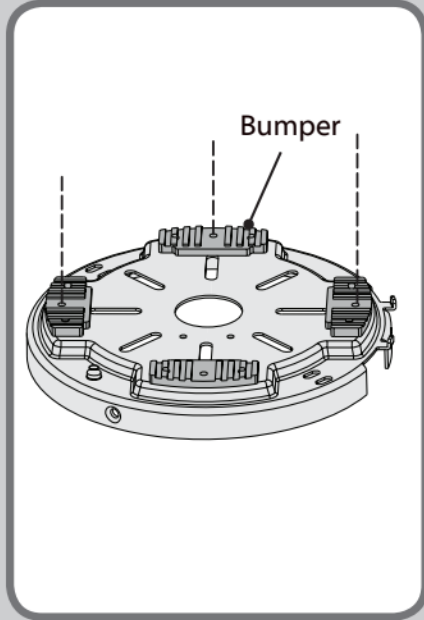
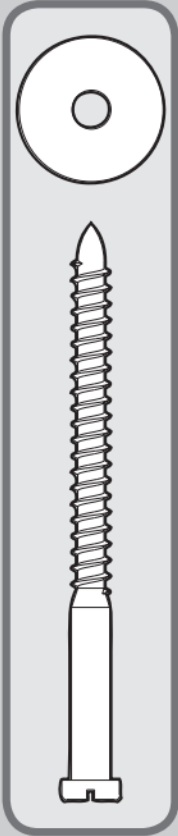
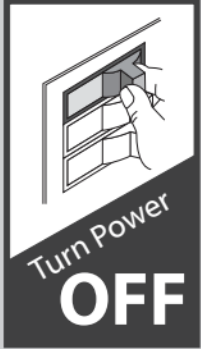

Make sure all four bumpers are still attached.

⚠ WARNING 
To avoid possible electrical shock, before installing your fan, disconnect the power by turning off the circuit breakers to the outlet box associated with the wall switch location.

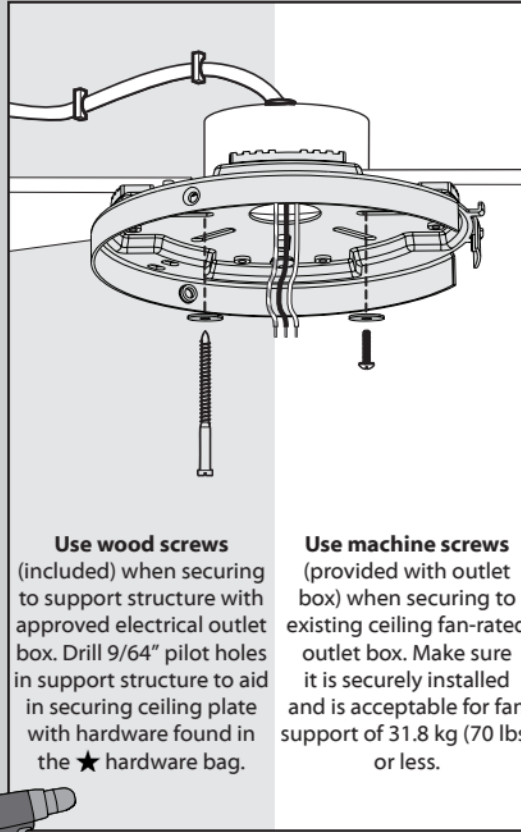

Use wood screws (included) when securing to support structure with approved electrical outlet box. Drill 9/64" pilot holes in support structure to aid in securing ceiling plate with hardware found in the ★ hardware bag.

Use machine screws (provided with outlet box) when securing to existing ceiling fan-rated outlet box. Make sure it is securely installed and is acceptable for fan support of 31.8 kg (70 lbs) or less.

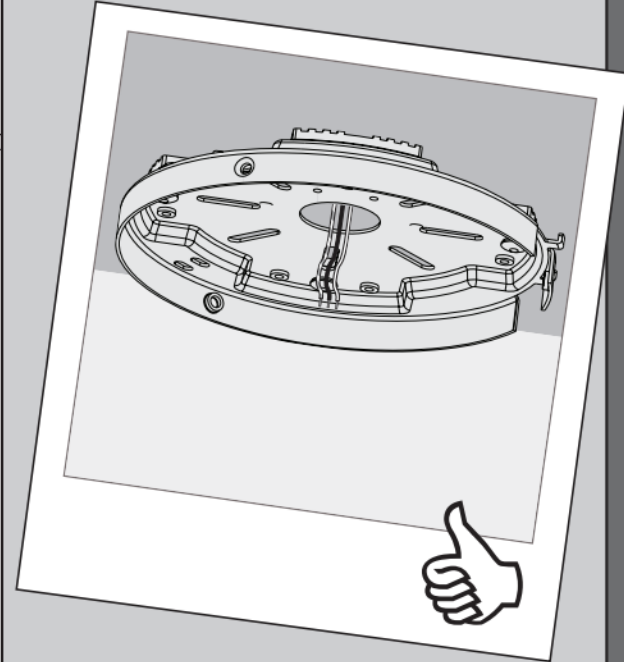

Refer to warning w.1 on pg. 2



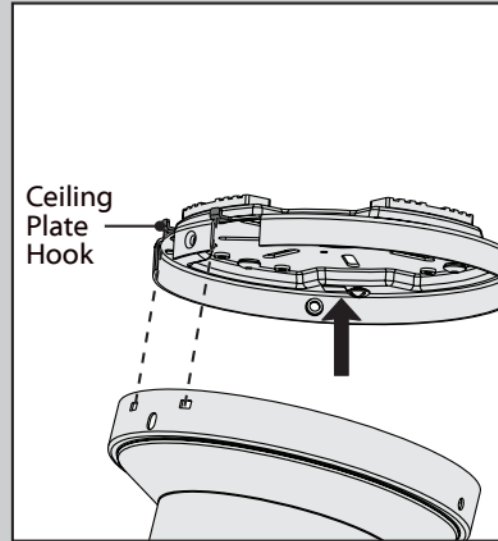
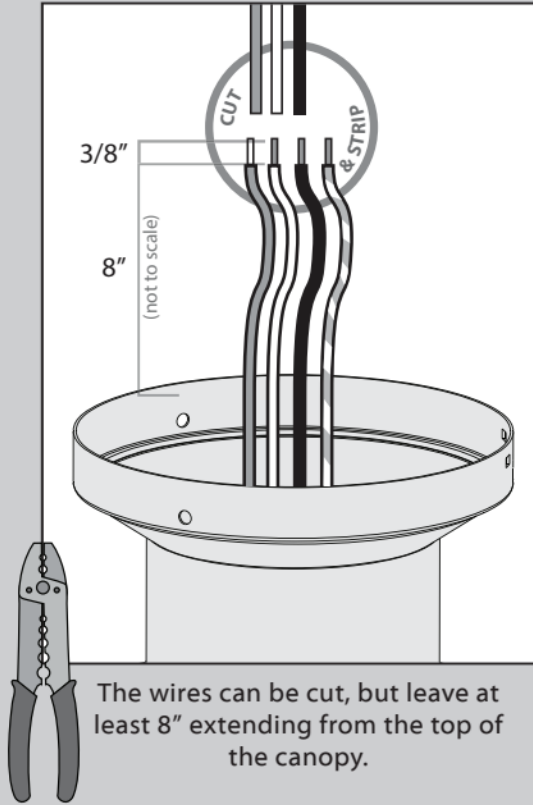

Raise the fan and align the slots in the canopy with the hooks on the ceiling plate.

Note: To hang the fan, you must tilt the canopy to an almost vertical position so that the canopy slots sit on the ceiling plate hooks.

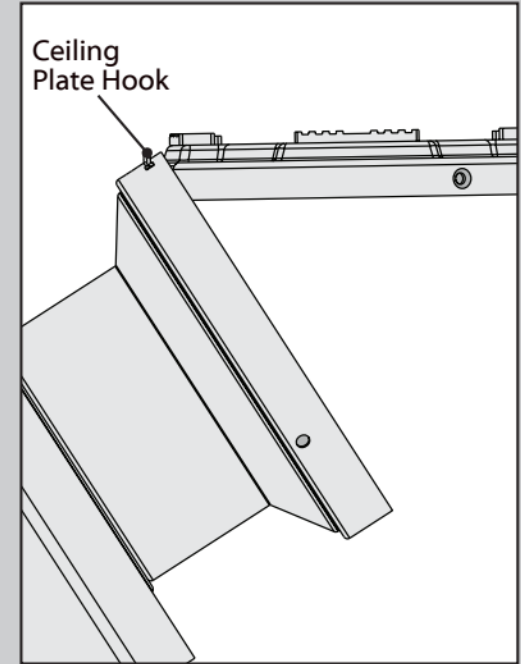

Place the slots over the ceiling plate hooks to hang the fan.

8"

3/8"



Have a single switch?
Follow these steps:



Dual Switch
Instructions

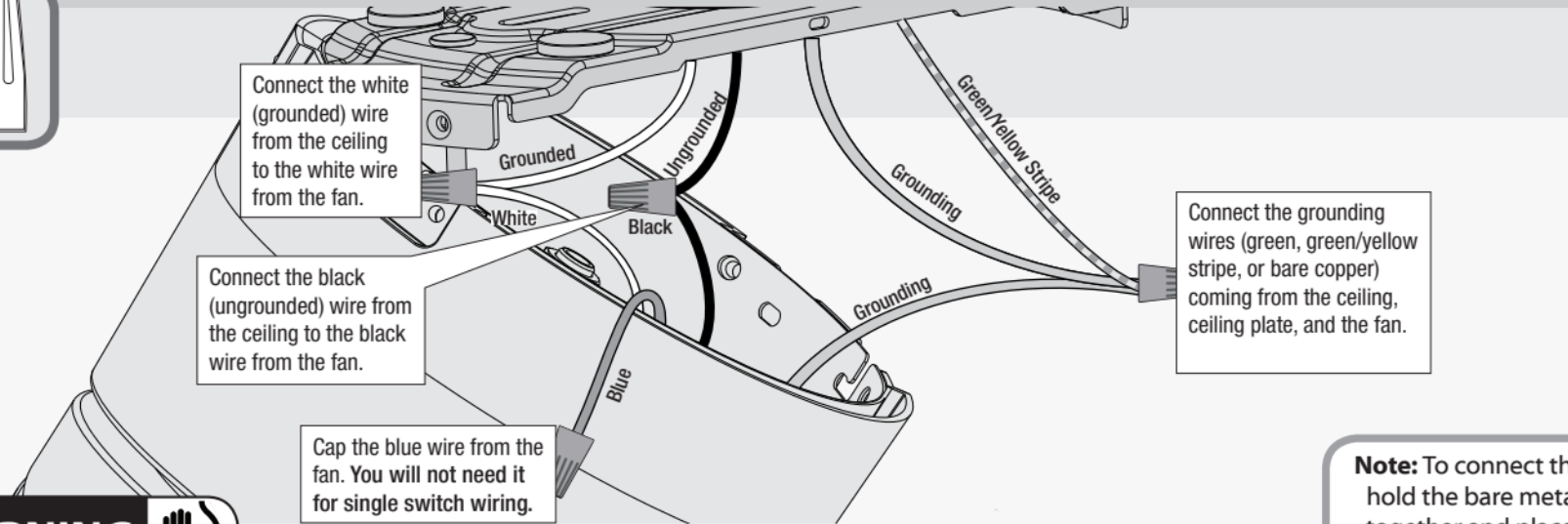
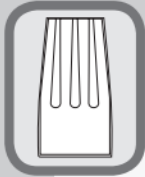

⚠ WARNING 
All wiring must be in accordance with national and local electrical codes ANSI/NFPA 70. If you are unfamiliar with wiring or in doubt, consult a qualified electrician.

Note: To connect the wires, hold the bare metal leads together and place a wire connector over them, then twist clockwise until tight.

Turn the splices upward and push them carefully back through the hanger bracket into the outlet box. Spread the wires apart, with the grounded wires on one side of the outlet box and the ungrounded wires on the other side of the outlet box.

Refer to CAUTION c.1 on pg. 2

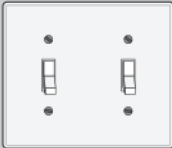

Have dual switches?
Follow these steps:

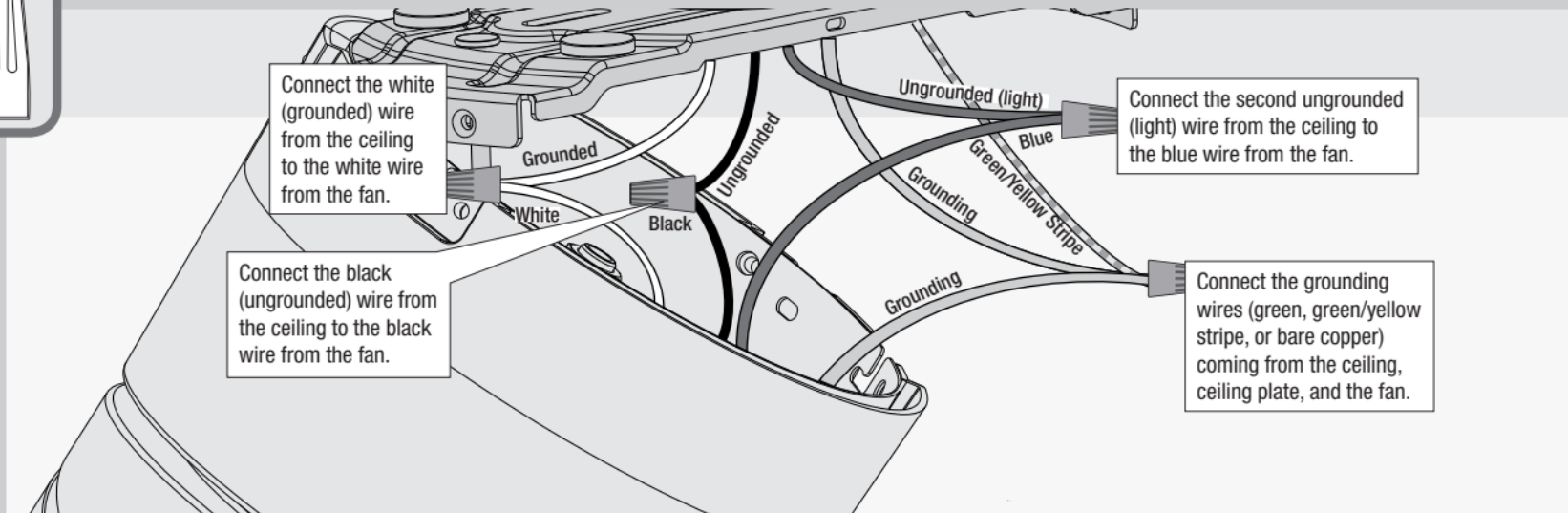
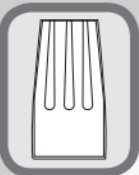

Note: To connect the wires, hold the bare metal leads together and place a wire connector over them, then twist clockwise until tight.

Refer to CAUTION c.1 on pg. 2

Turn the splices upward and push them carefully back through the hanger bracket into the outlet box. Spread the wires apart, with the grounded wires on one side of the outlet box and the ungrounded wires on the other side of the outlet box.

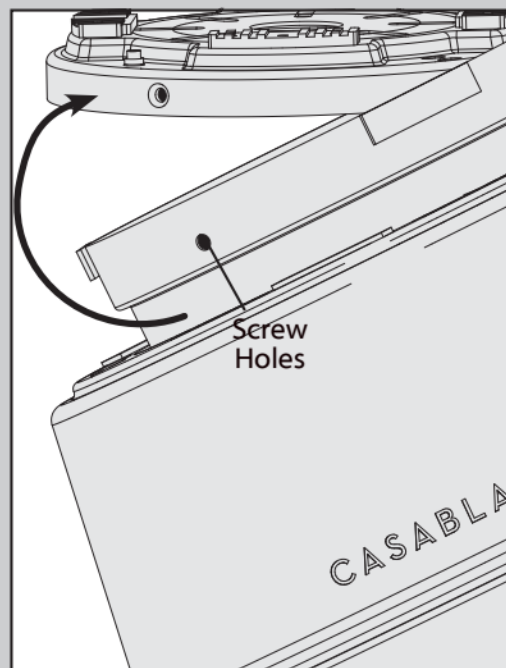

Swing the fan up to align the canopy screw holes with the mounting holes on the ceiling plate.

Note: The slots in the canopy must remain engaged while swinging the canopy for alignment.

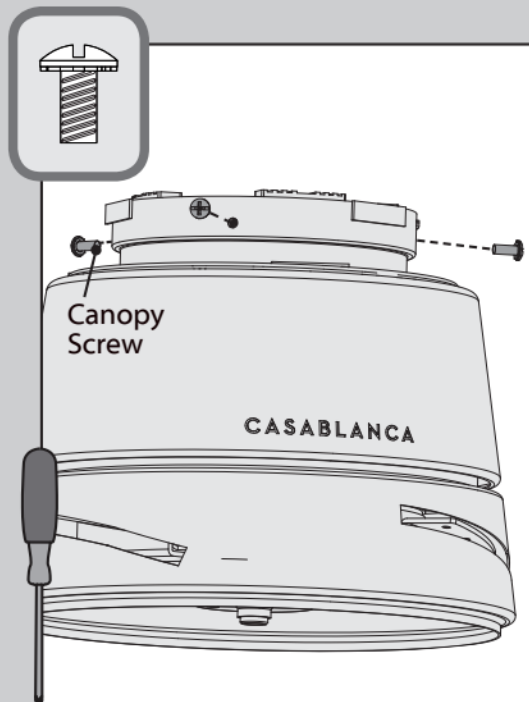

⊗ Hold the canopy up with the screw holes aligned. When all the holes are properly aligned, securely tighten all three canopy screws found in the ● hardware bag.

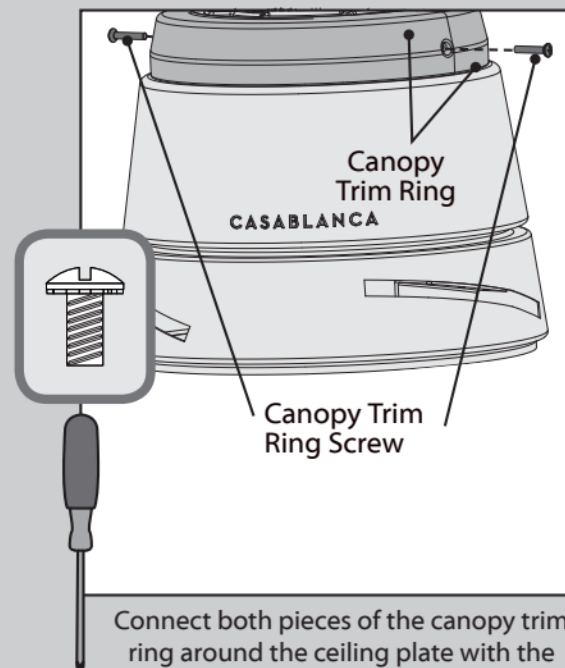

⊗ Connect both pieces of the canopy trim ring around the ceiling plate with the larger diameter facing the fan. Align screw holes on either side and fasten with screws found in the hardware bag.

⚠ WARNING

FAN FALL HAZARD
To prevent **SERIOUS INJURY** or **DEATH**, make sure that the canopy is properly secured.

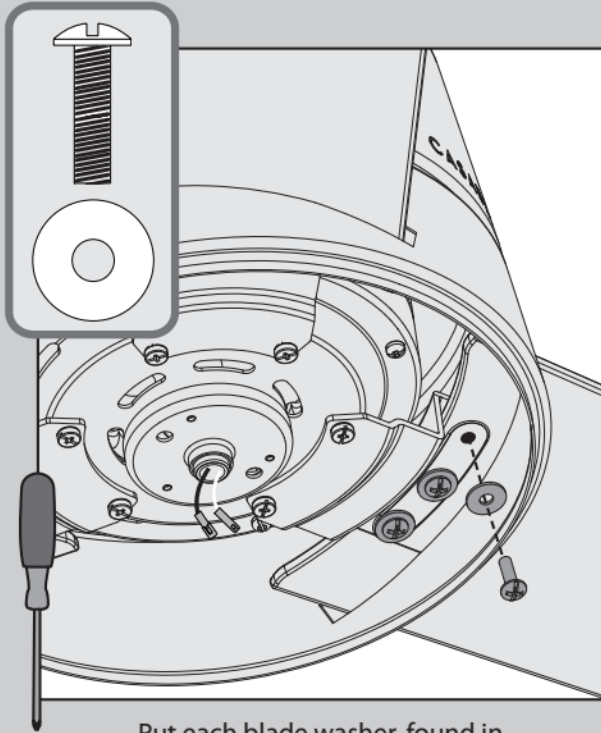

- ⊗ Put each blade washer, found in the ■ hardware bag, onto a blade screw, found in the ▲ hardware bag. Then secure each blade to a blade iron using the blade screws and washers.

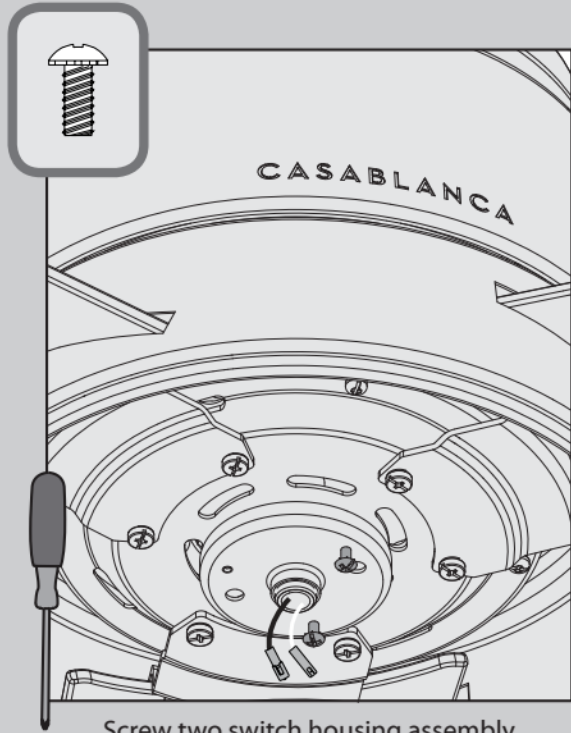

Screw two switch housing assembly screws, found in the  hardware bag, halfway into the mounting plate on the bottom of the motor housing. It does not matter which two screw holes you choose.

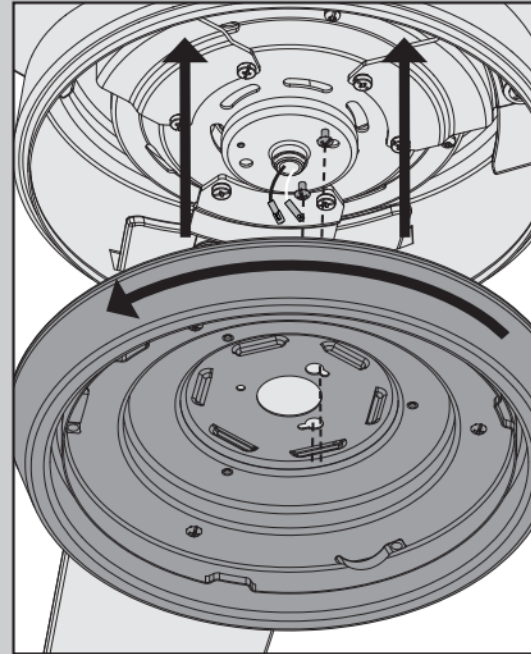

Feed the two single-pin connectors through the center hole of the upper switch housing, then wrap the keyhole slots around the screws and twist counterclockwise.

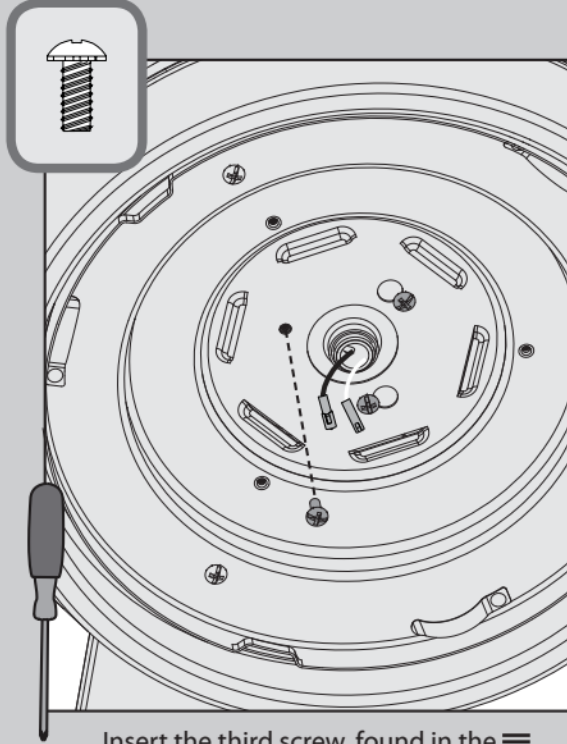

Insert the third screw, found in the ≡ hardware bag, into place and then tighten all three screws.

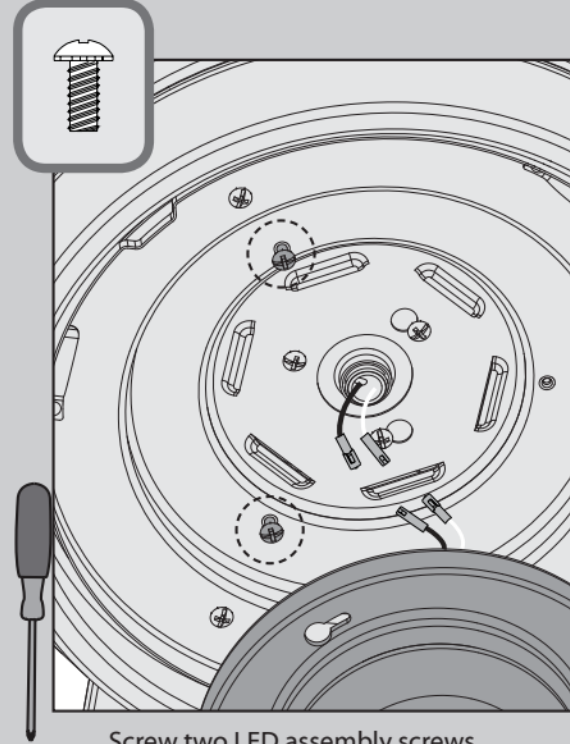

Screw two LED assembly screws, found in the ≡ hardware bag, halfway into the Switch housing. It does not matter which two screw holes you choose.

⚠ WARNING**FAN FALL HAZARD**

Make sure screws are tight to secure the upper switch housing to the mounting plate.

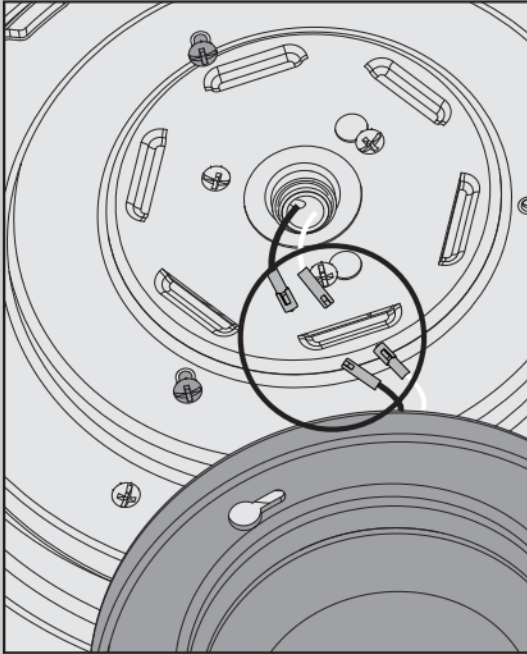

Connect the single-pin connectors from the LED assembly to the connectors from the fan. Connect the white wires together. Connect the blue and black wires together. Tuck the excess wiring above the LED assembly.

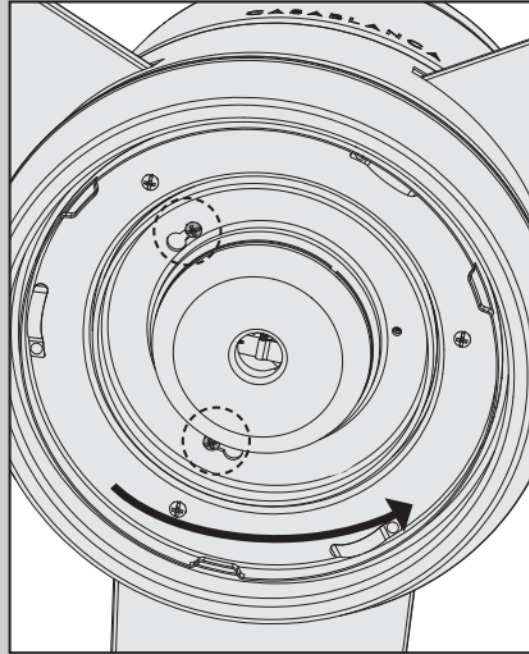

Wrap the keyhole slots around the screws and twist counterclockwise.

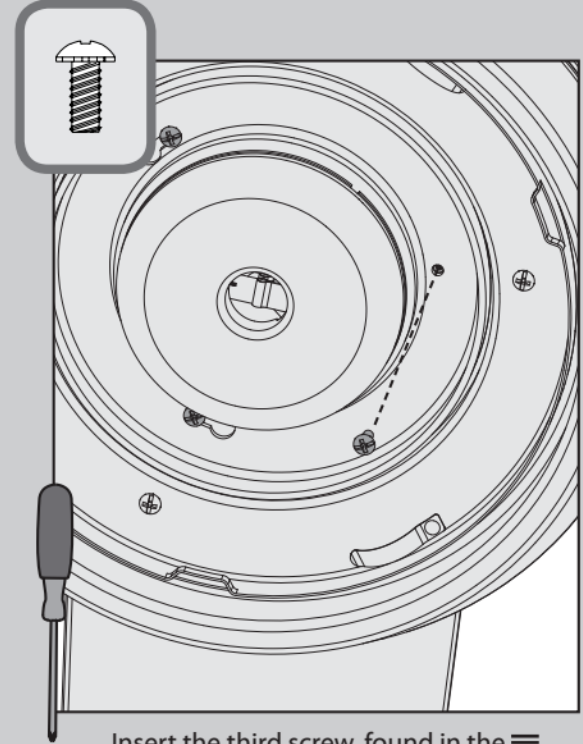

Insert the third screw, found in the  hardware bag, into place and then tighten all three screws.

⚠ WARNING

FAN FALL HAZARD

Make sure screws are tight to secure the light fixture.



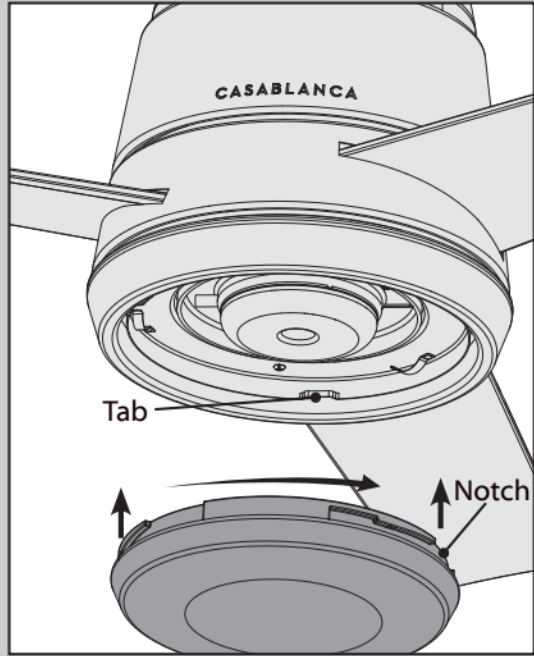

Position the notches in the outer rim of the globe so they line up with the three tabs on the inside rim of the housing. Carefully lift the globe up inside the housing as far as it will go, then rotate the globe clockwise until it is held tightly in place by the tabs.
NOTE: Check to ensure proper engagement

⚠ WARNING
GLASS FALL HAZARD
To prevent **SERIOUS INJURY** or **DEATH**, make sure that glass is properly secured.



See next page for fan operation instructions. →

! If you have a dual switch setup, go to page 18 for dual switch installation instructions.

- 1** Turning off the power
Ensure the power is OFF at the outlet box and wall switch location before proceeding with installation.



- 2** Installing the battery
To access the battery compartment, slide the battery door up.
Replace the used battery with two AAA batteries when needed.

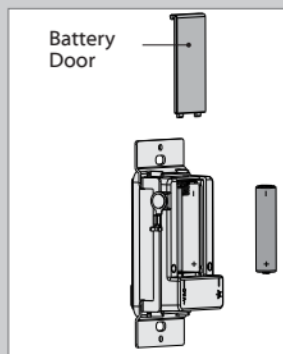

- 3** Installing the Wall Plate Bracket
Snap the Wall Control into the Wall Plate Bracket.

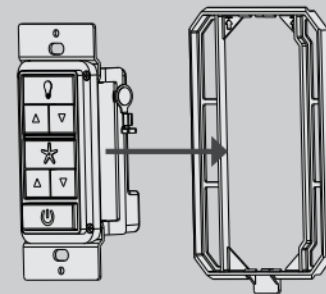

- 4** Wiring the Wall Control

1. Connect the grounding wire from the wall control to the ground control from the switch box using the provided wire nuts.
2. Connect the "LIVE IN" from the switch box to the "~VAC" from the wall control using the provided wire nuts.
3. Connect the "LIVE OUT" from the switch box to the "FAN" out from the wall control using the provided wire nuts.
4. Push all wires into the switch box.

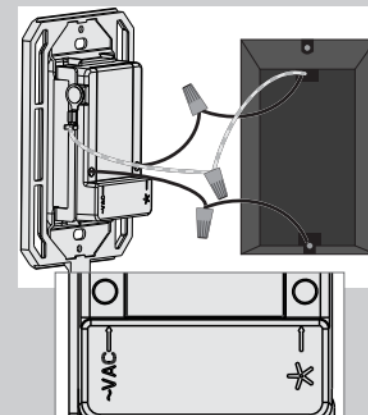

This device complies with Part 15 of the FCC Rules. Operation is subject to the following conditions: (1) this device may not cause harmful interference, and (2) this device must accept any interference received, including interference that may cause undesired operation.



5 Installing the Wall Control

Install the longer screws through the slots in the wall control into the switch box screw holes.

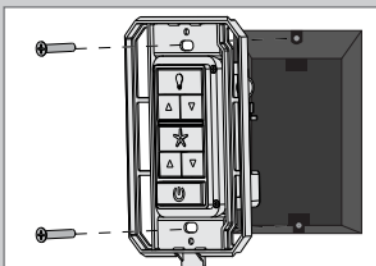

6 Installing the Wall Plate

Push the wall plate onto the Wall Plate Bracket. It should snap into place.

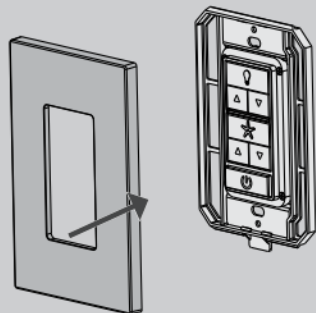

7 Turning on the power

⚠ IMPORTANT

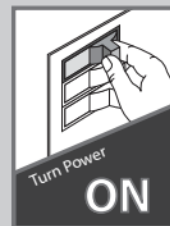

8 Reference the included remote function card for information on how to use your wall control!



To install the Casablanca Wall Control into a dual switch location, you will need a wall plate with both a standard switch and rocker switch cut-out (sold separately).

If you are unfamiliar or uncomfortable with wiring, please contact a qualified electrician.

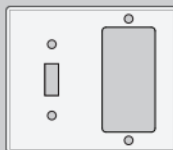

(Sold Separately)

1 Installing the battery

To access the battery compartment, slide the battery door up.

Replace the used battery with two AAA batteries when needed.

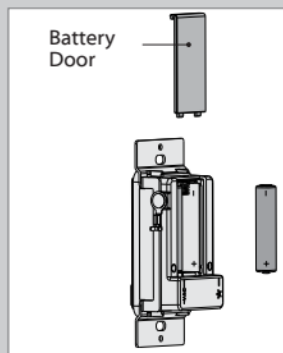

2 Verify which switch controls the fan light.

1. Turn on power for the fan.
2. Push both existing wall switches to the on position.
3. Press the Fan and Light button on the Casablanca Wall Control.
4. Your fan's light and fan should be on.
5. Push each of your existing wall switches into the off position one at a time to determine which switch controls the Light.
6. The Light switch will not be replaced when installing the Casablanca Wall Control. You may find it helpful to mark the Light switch with a pencil or some other non-permanent mark.



⚠ IMPORTANT

- ## 3 Turn off the power
- Ensure the power is OFF at the outlet box and wall switch location before proceeding with installation.

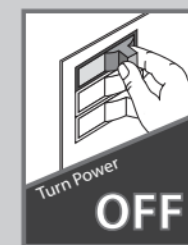



4 Remove the existing wall plate

Remove the existing wall plate. **Save the screws.** You will need them for the existing, marked light switch.



5 Remove the Casablanca Wall Control frame.

Remove the frame from the Casablanca Wall Control. You will not need it for the dual switch installation process.

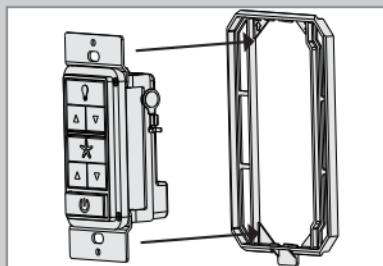

6 Wiring the Casablanca Wall Control

1. Connect the grounding wire from the wall control to the ground control from the switch box using the provided wire nuts.
2. Connect the "LIVE IN" from the switch box to the "-VAC" from the wall control using the provided wire nuts.
3. Connect the "LIVE OUT" from the switch box to the "FAN" out from the wall control using the provided wire nuts.
4. Push all wires into the switch box.

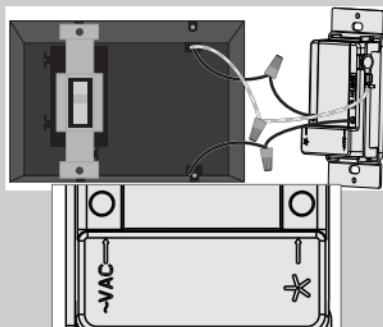

7 Install the Wall Plate

Install the wall plate that fits your setup (sold separately).

1. Use the screws you saved to reinstall into the light switch.
2. Use the screws included

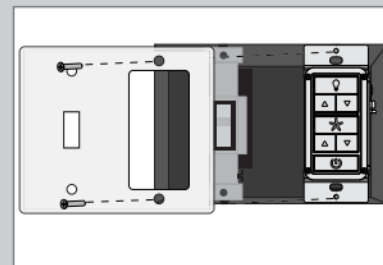

8 Installation complete

The existing light switch still controls the light on/off.

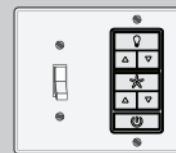





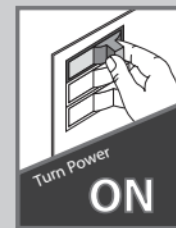

















9 Turn on the power

⚠ IMPORTANT



- 10 Reference the included remote function card for information on how to use your wall control!

KEY PRESS	FUNCTION
LIGHT FUNCTIONS	
	Light On/Off
 	Light Dimming Control
Long Press 	Light High
Long Press 	Light Low
Long Press  + 	Dimming Mode On/Off

KEY PRESS	FUNCTION
FAN FUNCTIONS	
	Fan On/Off
 	Fan Speed Control
Long Press 	Fan High
Long Press 	Fan Low
Long Press 	Fan Reverse
Long Press  + 	Fan Updraft
Long Press  + 	Fan Downdraft
	Power On/Off
Long Press  + 	Pair Function
Long Press  + 	Reset (For WiFi enabled fans ONLY)

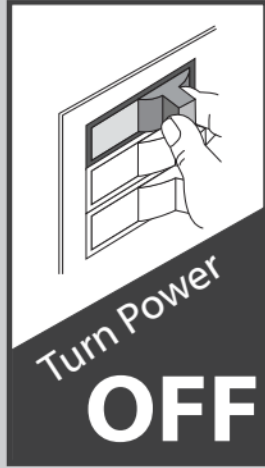

Be sure to turn off power to the fan before performing any maintenance.

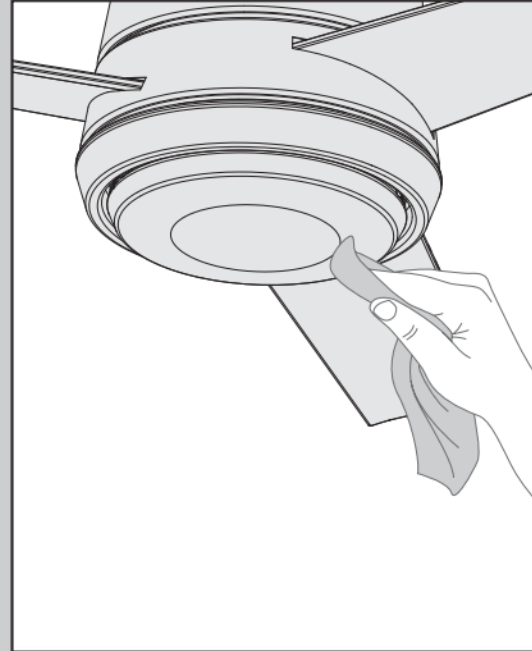

Cleaning the fan - use soft brushes or cloths to prevent scratching. Cleaning products may damage the finishes.

Fan doesn't work

- Press a fan speed button (up or down arrow).
- Check the circuit breaker to ensure the power is turned on.
- Check the wall control battery.
- Make sure the blades spin freely.
- Turn off power from the circuit breaker, then loosen the canopy and check all the connections according to the wiring diagram.

Fan keeps spinning after power is turned off

- The blades may take a few minutes to come to a complete stop. The powerful Casablanca motor combined with the unique blade design on this fan allows for great air movement, but this may cause the blades to keep spinning for longer than expected after power is turned off.

Remote does not work

- Make sure the battery is installed correctly.
- Install a new battery.
- If the remote still does not work, you may need to pair your remote. **To prevent faulty operation, please disconnect power (at the wall switch, breaker, or fan) from all other ceiling fans within range while pairing.** To pair: cycle power to the fan by turning power off and back on at the wall switch (or circuit breaker if necessary). Within three minutes, press and hold both the Fan and Light button for four seconds to pair the remote. If applicable, the fan will turn on and the lights will flash and stay on to indicate successful pairing.

LED lights will not dim

- To enable dimming, you must first set your remote to Dimming Mode. To toggle Dimming Mode on or off, long press the up and down button together.

AUTHORIZED SERVICE CENTERS

For the most updated list of Casablanca Authorized Service Centers, visit www.CasablancaFanCo.com or call toll free 1-888-227-2178.

Installing Multiple Fans with Independently Operating Remote Controls

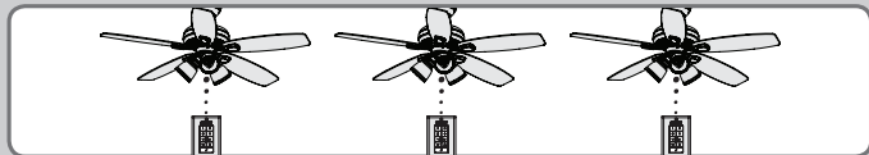

To install multiple fans with independently operating remote controls, **there is no need to perform any pairing procedures.** Each set of receiver/transmitter is already paired. Simply install each receiver into a fan and use the appropriate transmitter to operate each fan.

If your remote is not working, see the “Remote does not work” section on the previous page.

Installing Multiple Fans Operating on a Single Remote Control



To have multiple fans operated by a single remote control, you must pair the transmitter to each additional receiver. The receiver that shipped with your fan is already paired to the transmitter.

Note: To prevent faulty operation, you MUST disconnect power (at the wall switch, breaker, or fan) from all other ceiling fans within range while pairing each fan.

For each additional fan, ensure that a compatible receiver is installed. Disconnect power from all other fans while pairing. To pair: cycle power to the fan by turning power off and back on at the wall switch (or circuit breaker if necessary). Within three minutes, press and hold both the Fan and Light button for four seconds to pair/unpair the remote. If applicable, the fan will turn on and the lights will flash and stay on to indicate successful pairing.

Installing One Fan Operating on Multiple Remote Controls



To have multiple remote controls operate one fan, you must pair each additional transmitter to the receiver in the fan. The transmitter that shipped with your fan is already paired.

Note: To prevent faulty operation, please disconnect power (at the wall switch, breaker, or fan) from all other ceiling fans within range while pairing.

For each additional transmitter, cycle power to the fan by turning power off and back on at the wall switch (or circuit breaker if necessary). Within three minutes, press and hold both the Fan and Light button for four seconds to pair the remote. If applicable, the fan will turn on and the lights will flash and stay on to indicate successful pairing.

“Unpairing” Procedure for Faulty Operation of Remote Controls

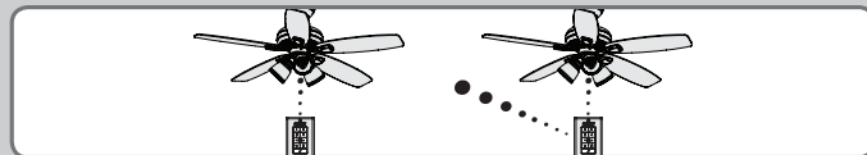

If a transmitter is mistakenly operating a fan, you need to “unpair” the transmitter from that fan’s receiver. The “unpairing” procedure is the same as the pairing procedure.

Note: To prevent faulty operation, you MUST disconnect power (at the wall switch, breaker, or fan) from all other ceiling fans within range while “unpairing” a fan.

Disconnect power from all other fans while “unpairing.” Then, cycle power to the fan you wish to “unpair” by turning power off and back on at the wall switch (or circuit breaker if necessary). Within three minutes, press and hold both the Fan and Light button for four seconds to “unpair” the remote. If applicable, the fan will turn off and the lights will flash and turn off to indicate successful “unpairing.”