



FOODI® POWER MIXER™ SYSTEM CI100 Series | Owner's Guide



IMPORTANT SAFETY INSTRUCTIONS

PLEASE READ CAREFULLY BEFORE USE • FOR HOUSEHOLD USE ONLY

	Read and review instructions for operation and use.
	Indicates the presence of a hazard that can cause personal injury, death or substantial property damage if the warning included with this symbol is ignored.
	For indoor and household use only.
When using electrical appliances, basic safety precautions should always be followed, including the following:	

⚠ WARNING

To reduce the risk of injury, fire, electrical shock or property damage, basic safety precautions must always be followed, including the following numbered warnings and subsequent instructions. Do not use appliance for other than intended use.

- 1 Read all instructions prior to using the appliance and its accessories.
- 2 Carefully observe and follow all warnings and instructions. This unit contains electrical connections and moving parts that potentially present risk to the user.
- 3 **ALWAYS** exercise care when handling the immersion blender attachment. The blades are sharp; handle carefully. **ONLY** grasp the immersion blender attachment by the upper bell or shaft. Failure to use care when handling the immersion blender attachment will result in a risk of laceration.
- 4 **ALWAYS** exercise care when handling the chopper blades. The blades are sharp; handle carefully. **ONLY** grasp the chopper blade by the shaft. Failure to use care when handling the chopper blade will result in a risk of laceration.
- 5 Immersion blender arm blades and chopper blades are sharp, the chopper blade is loose. Handle carefully.
- 6 Before each use, inspect blades for damage. If a blade is bent or damage is suspected, contact SharkNinja to arrange for replacement.
- 7 **DO NOT** attempt to sharpen blades.
- 8 Take your time and exercise care during unpacking and appliance setup. This appliance contains sharp, loose blades that can cause injury if mishandled.
- 9 Take inventory of all contents to ensure you have all parts needed to properly and safely operate your appliance.
- 10 Unplug the appliance from the outlet when not in use, before assembling or disassembling parts, and before cleaning. To unplug, grasp the plug by the body and pull from the outlet. **NEVER** unplug by grasping and pulling the flexible cord.
- 11 Before use, wash all parts that may contact food. Follow washing instructions covered in this instruction manual.
- 12 To protect against the risk of electric shock, **DO NOT** submerge the power base, hand mixer attachment or the chopper processing lid. **DO NOT** allow the power cord to contact any form of liquid. Unplug the power base before cleaning.
- 13 Remove any accessories from the hand mixer attachment before washing.
- 14 **DO NOT** use this appliance outdoors. It is designed for indoor household use only.

IMPORTANT SAFETY INSTRUCTIONS

PLEASE READ CAREFULLY BEFORE USE • FOR HOUSEHOLD USE ONLY

⚠ WARNING

To reduce the risk of injury, fire, electrical shock or property damage, basic safety precautions must always be followed, including the following numbered warnings and subsequent instructions. Do not use appliance for other than intended use.

- 15 This appliance has important markings on the plug. The attachment plug or entire cordset (if plug is molded onto cord) is not suitable for replacement. If damaged, the appliance shall be replaced.
- 16 This appliance has a polarized plug (one prong is wider than the other). To reduce the risk of electric shock, this plug will fit in a polarized outlet only one way. If the plug does not fit fully in the outlet, reverse the plug. If it still does not fit, contact a qualified electrician. **DO NOT** modify the plug in any way.
- 17 **DO NOT** operate any appliance with a damaged cord or plug, or after the appliance malfunctions or is dropped or damaged in any manner. This appliance has no user-serviceable parts. If damaged, contact SharkNinja for servicing.
- 18 Extension cords should **NOT** be used with this appliance.
- 19 **DO NOT** allow children to operate this appliance or use as a toy. Close supervision is necessary when any appliance is used near children.
- 20 This appliance is **NOT** intended to be used by people with reduced physical, sensory, or mental capabilities, or lack of experience and knowledge, unless they have been given supervision or instruction concerning use of the appliance by a person responsible for their safety.
- 21 Fully unwind the power cord before use. **DO NOT** allow the unit or the cord to hang over the edges of tables or counters. The cord may become snagged and pull the appliance off the work surface.
- 22 **DO NOT** allow any part of the unit to contact hot surfaces, including stoves and other heating appliances.
- 23 **ALWAYS** use the appliance on a dry and level surface.
- 24 Keep hands, hair, and clothing out of the container when loading and operating.
- 25 **ONLY** use attachments and accessories that are provided with the product or are recommended by SharkNinja. The use of attachments not recommended or sold by SharkNinja may cause fire, electric shock, or injury.
- 26 During operation and handling of the appliance, avoid contact with moving parts.
- 27 **DO NOT** operate the appliance with an empty container.
- 28 **DO NOT** fill containers past the MAX FILL or MAX LIQUID lines.
- 29 **DO NOT** microwave any containers or accessories provided with the appliance, except the blending vessel.
- 30 **DO NOT** perform grinding operations.
- 31 Before operation, ensure all utensils are removed from containers. Failure to remove utensils can cause containers to shatter and potentially result in personal injury and property damage.
- 32 **NEVER** operate the chopper attachment without the lid in place. **DO NOT** attempt to defeat the interlock mechanism. Ensure the container and lid are properly installed before operation.
- 33 **DO NOT** expose the containers and accessories to extreme temperature changes. They may experience damage.
- 34 **NEVER** leave the appliance unattended while in use.
- 35 **DO NOT** blend hot liquids in the 3-cup blending vessel, 4-cup blending pitcher and the chopper bowl. Doing so may result in pressure buildup and steam exposure that can pose a risk of the user being burned.
- 36 If you find unmixed ingredients sticking to the sides of the chopper bowl, stop the appliance, remove the blade assembly, and use a scraper to dislodge ingredients.
- 37 **DO NOT** remove the power base and lid while the chopper blade is still spinning. Allow the appliance to come to a complete stop before removing the power base and lid.

SAVE THESE INSTRUCTIONS

- 38 Remove the chopper blades from the chopper bowl upon completion of processing. **DO NOT** store ingredients before or after processing them in the bowl with the blades attached. Some foods may contain active ingredients or release gases that will expand if left in a sealed container, resulting in excessive pressure buildup that can pose a risk of injury. For ingredient storage in the vessel, use only the provided storage lid.
- 39 **DO NOT** process dry ingredients without adding liquid to the immersion blender, or chopper attachments. They are not intended for dry blending.
- 40 Keep hands and utensils out of containers while processing to reduce the risk of severe personal injury or damage to the unit. A scraper may be used **ONLY** when the unit is not running.
- 41 Immediately release the power button on the power base in the event that the appliance malfunctions during of the immersion blender. Immediately press the power button on the hand mixer handle in the event that the appliance malfunctions during use of the hand mixer.
- 42 Make sure that the chopper lid is securely attached to the chopper bowl before operating the chopper attachment.
- 43 Make sure that the power base is securely attached to the hand mixer attachment, immersion blender attachment, or chopper assembly
- 44 Always ensure the hand mixer accessories are fitted securely in place into the hand mixer attachment before processing.
- 45 **DO NOT** use containers if they are cracked or chipped.
- 46 The maximum wattage rating can be achieved by chopping 190g white kidney beans in the chopper bowl. Other configurations may draw less power. Operation time should **NOT** exceed 15 seconds.
- 47 To avoid contact with steam and hot surfaces, **DO NOT** reach across top of vessel in which you are processing.
- 48 If the appliance overheats, a thermal switch will activate and temporarily disable the motor. To reset, unplug the appliance and allow it to cool for approximately 15 minutes before using again.

PARTS

NOTE: Attachments and accessories vary by model.

- A Power Base
(attached power cord not shown)
- B Hand Mixer Attachment
- C Immersion Blender Attachment
- D Beater x2
- E Dough Hook* x2
- F Whisk*
- G Chopper Processing Lid*
- H Chopper Blade Assembly*
- I 3-Cup Chopper Bowl*
- J Chopper Storage Lid*
- K 3-Cup Blending Vessel*

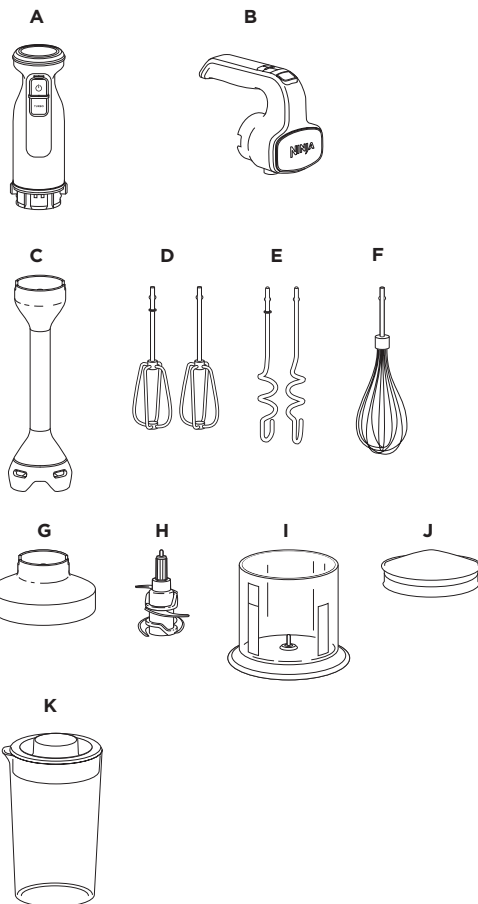

*Not included with all models

There are a variety of accessories that are compatible with this Power Mixer™ System series.

To purchase more accessories and find great recipes, visit ninjakitchen.com.

BEFORE FIRST USE

IMPORTANT: Review all warnings before proceeding

NOTE: Attachments and accessories vary by model.

- 1 Remove all packaging materials from the unit. Exercise care when unpacking the immersion blender attachment and chopper blade assembly.
- 2 Wash immersion blender attachment, beaters, dough hooks, whisk, chopper bowl, storage lid, and chopper blade assembly in warm, soapy water. Use a dishwashing utensil with a handle to avoid direct contact with the blades on the immersion blender attachment and the chopper blade assembly. Exercise care when handling blade assemblies, as blades are sharp. Thoroughly rinse and air-dry all parts.
- 3 Wipe the power base, hand mixer attachment and chopper processing lid with a clean, damp cloth.

CONTROL PANEL



IMPORTANT: Review all warnings before proceeding

USING THE HAND MIXER CONTROL PANEL

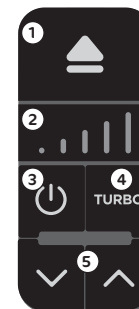
- 1 **EJECT**
Push to remove the beaters or other accessories.
- 2 **SPEED RANGE INDICATOR**
LEDs illuminate to indicate speed settings 1 through 5.
- 3 **POWER**
Press  to turn the unit on or off.
- 4 **TURBO**
Press and **hold** to quickly jump to speed 5.
- 5 **SPEED SELECTOR**
Increase or decrease speed by pressing the up and down arrow buttons.



USING THE IMMERSION BLENDER CONTROL PANEL

- 1 **POWER**
Press  and **hold continuously** to blend. The unit will not blend unless the power button is pressed down.
- 2 **TURBO**
While continuously holding the  to blend, press and hold the TURBO button to ramp up to high speed. By default, the unit will start on low speed.



USING THE CHOPPER CONTROL PANEL

- 1 **POWER**
Press  and **hold continuously** to process. Use short presses for short pulses and long presses for long pulses.
- 2 The TURBO button is **disabled** when using the chopper attachment.



HAND MIXER ATTACHMENT ASSEMBLY

(accessories vary by model)

IMPORTANT:

- Review all warnings before proceeding
- The hand mixer attachment is **NOT** dishwasher safe.

- 1 Install the hand mixer attachment to the power base by aligning the arrow on the power base with the arrow on the mixer attachment. Then, push the power base onto the attachment to lock into place.

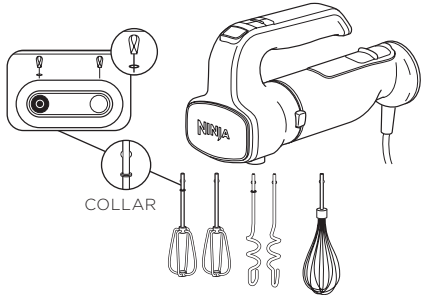
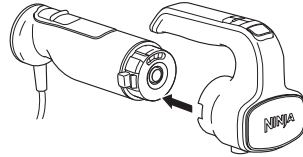

- 2 Attach both beaters, dough hooks, or the whisk using the accessory slots on the mixer head. Insert the beater or dough hook with the collar into the slot with the diagram showing a collar. The whisk can be inserted into either slot. You will hear a slight click when locked in place.

- 3 Plug the unit in and power on. The unit will begin mixing on speed 1. Use the speed selector to increase or decrease speed.

Speeds 1 & 2	Use speeds 1-2 when combining dry ingredients, such as flour, into liquid ingredients and when making thicker doughs, such as bread doughs.
Speeds 3 & 4	Use speeds 3-4 when making cookie doughs, batters, quick breads, frostings, and most other recipes.
Speed 5	Use speed 5 for whipping cream, mousse, or egg whites.
NOTE: Start on speed 1, then slowly ramp up to prevent ingredients from splattering.	

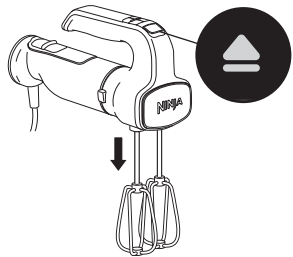

- 4 Press to turn the unit off. To remove the beaters or other accessories, press the eject button. Ensure the beaters or other accessories come to a complete stop before pressing the eject button.

- 5 To remove the power base from the hand mixer attachment, first press the power button to turn the unit off, then unplug the unit. Press and hold the release buttons on either side of the power base to remove the mixer attachment.

- 6 Refer to the Care & Maintenance section for cleaning and storage instructions.

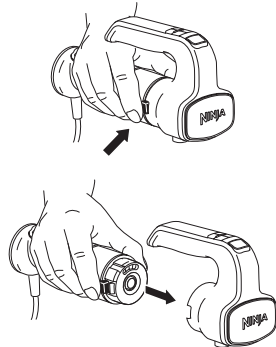

IMMERSION BLENDER ATTACHMENT ASSEMBLY

(accessories vary by model)

IMPORTANT: Review all warnings before proceeding

- 1 Install the immersion blender attachment to the power base by aligning the arrow on the power base with the arrow on the immersion blender attachment. Then, push the power base onto the attachment to lock into place. Plug the unit in.

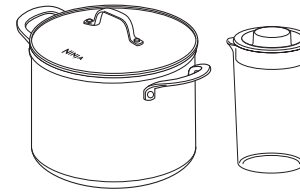
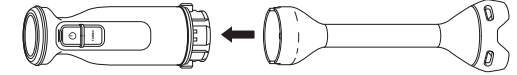

- 2 Prior to blending, make sure to use a container large enough to fully submerge the blender head in ingredients. Once submerged, there should be ample room in the container to avoid overflowing and splashing. A cooking pot, large measuring container, or the blending vessel (not available with all models) is recommended.

- 3 Submerge the vents of the blender head in the ingredients. Press and **hold** the while using an up-and-down motion to blend, making sure to stop blending anytime the vents are no longer submerged. While continuously holding to blend, press and hold the TURBO button to ramp up to high speed.

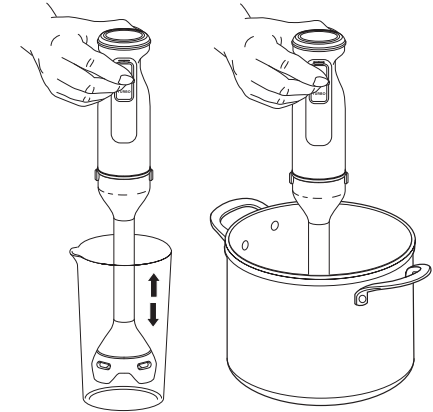

LOW	Use to blend liquids, such as mayo or dressing, or soups and sauces with soft ingredients, such as tomato sauce.
TURBO	Use for tougher ingredients, such as butternut squash, or for smooth purees, such as hummus.

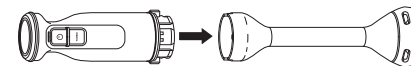
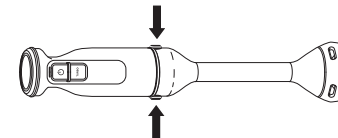

- 4 To remove the power base from the immersion blender attachment, first unplug the unit. Press and hold the release buttons on either side of the power base to remove the immersion blender attachment.

- 5 Refer to the Care & Maintenance section for cleaning and storage instructions.

USING THE 3-CUP CHOPPER (not included with all models)

IMPORTANT:

- Review all warnings before proceeding.
- The processing lid is **NOT** dishwasher safe.

NOTE:

- **DO NOT** add ingredients before completing installation of the blade assembly.
- **DO NOT** operate the chopper continuously for more than 15 seconds at a time.
- **DO NOT** fill past the MAX FILL line.

- 1 Place the chopper bowl on a clean, dry, level surface, such as a countertop or table.
- 2 Exercising care, grasp the blade assembly by the top of the shaft and place it onto the drive gear inside the chopper bowl.
- 3 Add ingredients to the chopper bowl, then place the processing lid on top of the bowl, aligning the lid with the notches in the bowl. Ensure the lid is fully installed; there will be no click.

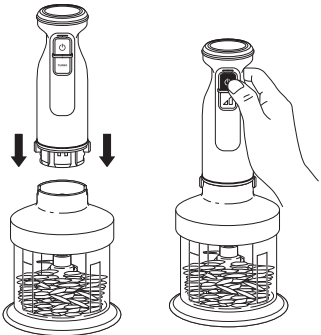

- 4 Attach power base by aligning the arrow on the power base with the arrow on the processing lid, then push the power base onto the lid to lock it in place. Plug the unit in.
- 5 Press and **hold** the  button to process. Use short presses for short pulses and long presses for long pulses. The TURBO button is **disabled** when using the chopper attachment.

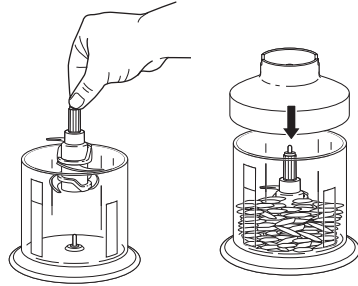

- 6 When finished, unplug the unit. Remove the power base from the chopper attachment by pressing and holding the release buttons on either side of the power base and lifting up.
- 7 Remove the lid by lifting it up. Always remove the blade assembly before emptying ingredients from the bowl by carefully grasping it by the top of the shaft and lifting it out of the bowl.
- 8 **DO NOT** store blended contents with the blade assembly and processing lid attached. Only use the storage lid.
- 9 Refer to the Care & Maintenance section for cleaning and storage instructions.

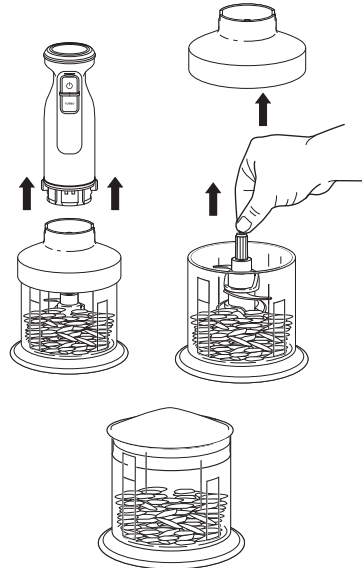

CARE & MAINTENANCE

WARNING: Handle the chopper blade with care when washing, as the blades are sharp. Contact with the blade's edges can result in laceration.

CLEANING

• Hand-Washing

Wash immersion blender attachment, beaters, dough hooks, whisk, chopper bowl, storage lid, and blade assembly in warm, soapy water. Use a dishwashing utensil with a handle to avoid direct contact with the blades on the immersion blender attachment and the chopper blades. Exercise care when handling blade assemblies, as blades are sharp. Thoroughly rinse and air-dry all parts.

• Dishwasher

All attachments, with the exception of the power base, hand mixer attachment and the chopper processing lid, are dishwasher safe.

• Motor Base, Hand Mixer Attachment, Chopper Processing Lid

Unplug the power base before cleaning. Wipe the power base, hand mixing attachment, and chopper processing lid with a clean, damp cloth. Do not submerge these parts in water.

• STORING

For cord storage, wrap the cord with the plastic clip.

RESETTING THE MOTOR

This unit features a unique safety system that prevents damage to the motor and drive system should you inadvertently overload it. If the unit is overloaded, the motor will be temporarily disabled. Should this occur, follow the reset procedure below.

- 1 Unplug the unit from the electrical outlet.
- 2 Allow the unit to cool for approximately 15 minutes.
- 3 Remove the attachment. Make sure no ingredients are jamming the accessory.

IMPORTANT: Ensure that maximum capacities are not exceeded. This is the most typical cause of appliance overload.

If your unit needs servicing, please call Customer Service at 1-877-646-5288. So we may better assist you, please register your product online at registryourninja.com and have the product on hand when you call.

ORDERING REPLACEMENT PARTS & ACCESSORIES

To order additional parts and attachments, visit ninjaaccessories.com.



4-Cup Blending Pitcher:

Large pitcher perfectly designed for the immersion blender attachment to blend your favorite recipes.

TROUBLESHOOTING GUIDE

⚠ WARNING: To reduce the risk of shock and unintended operation, turn power off and unplug unit before troubleshooting.

Unit doesn't turn on.

- Ensure the unit is plugged into a working outlet.
- Make sure to fully lock an attachment onto the power base. Align the arrow on the power base with the arrow on the desired attachment. Then push the power base onto the attachment to lock in place.
- Check that the bottom of power base is clean and there is no food blocking connection when installing attachments.
- When using the chopper, make sure that the blade is properly installed and the processing lid is sitting in the notches of the chopper bowl.

Hand mixer control panel is illuminated but mixer will not start.

- Press power (⏻) on the hand mixer handle, and the unit will automatically start.

Cannot install hand mixer accessories or hand mixer accessories are wobbly when installed.

- To install the hand mixer accessories, match the beater or dough hook that has the collar (the disc on the shaft) to the hole on the hand mixer with the icon of a collar.

Hand mixer is spraying ingredients.

- Use speed 1 when combining dry and liquid ingredients.
- Start on speed 1 and slowly ramp up to prevent ingredients from splattering.

Immersion blender will only run momentarily.

- Press and hold the ⏻ to blend. Holding the power button continuously to blend ensures that the blade only runs when you're in control.

Immersion blender is spraying ingredients.

- We recommend using a cooking pot, a large glass measuring container or the included blending vessel (not included with all models) to blend ingredients.
- The container should be large enough for the blender head to be fully submerged in the ingredients, along with ample room in the container to avoid overflowing and splashing.
- Submerge the vents of the blender head in the ingredients. Move the immersion bell in an up-and-down motion through the ingredients to blend, making sure to stop blending anytime the vents are not submerged.

Food is stuck in immersion blender blade.

- Power the unit off and unplug the power base. Use a spatula or other kitchen utensil to dislodge the food. Handle the immersion blender attachment with care and do not attempt to dislodge food using your hand.

Chopper moves on counter while processing.

- Make sure the countertop and base of chopper bowl are clean and dry.
- Grip the power base with one hand with the control panel facing away from you while holding the chopper bowl with your other hand.

Food is unevenly chopped.

- Make sure that the maximum capacity on the chopper bowl has not been exceeded.
- Ingredient pieces could be too large. Cut food into 1-inch pieces and process smaller amounts per batch.

Food is chopped too fine or is too watery.

- The food has been over processed. Use brief pulses or process for shorter time. Let the chopper blade assembly stop completely between pulses.

Cannot adjust speeds when chopper is attached; lower button on the control panel does not work.

- When the chopper attachment is installed, TURBO is disabled. Simply press and hold ⏻ to run at the optimal speed.

Cannot remove attachments.

- Be sure to press the release buttons on the side of the power base to remove attachments. Do not pull hand mixer accessories from the power base without using the release buttons.
- To remove hand mixer accessories, press the eject button on the top of the hand mixer control panel.

The unit stopped blending or mixing.

- Do not run the unit more than 10 minutes continuously. Unplug the unit from the electrical outlet and allow it to cool for 15 minutes.

Hand mixer control panel is flashing.

- The unit may have overheated or there is something jammed in the attachments. Unplug the unit from the electrical outlet and allow it to cool for 15 minutes. Remove the beaters or other accessories and ensure no ingredients are jamming the attachments. If output is too thick and ingredients are not processing properly, add more liquid.

Shark | NINJA

ONE (1) YEAR LIMITED WARRANTY

The One (1) Year Limited Warranty applies to purchases made from authorized retailers of **SharkNinja Operating LLC**. Warranty coverage applies to the original owner and to the original product only and is not transferable.

SharkNinja warrants that the unit shall be free from defects in material and workmanship for a period of one (1) year from the date of purchase when it is used under normal household conditions and maintained according to the requirements outlined in the Owner's Guide, subject to the following conditions and exclusions:

What is covered by this warranty?

1. The original unit and/or non-wearable parts deemed defective, in SharkNinja's sole discretion, will be repaired or replaced up to one (1) year from the original purchase date.
2. In the event a replacement unit is issued, the warranty coverage ends six (6) months following the receipt date of the replacement unit or the remainder of the existing warranty, whichever is later. SharkNinja reserves the right to replace the unit with one of equal or greater value.

What is not covered by this warranty?

1. Normal wear and tear of wearable parts (such as blending vessels, lids, blades, PowerBase™, dough hooks, whisk, beaters, etc.), which require regular maintenance and/or replacement to ensure the proper functioning of your unit, are not covered by this warranty. Replacement parts are available for purchase at ninjaaccessories.com.
2. Any unit that has been tampered with or used for commercial purposes
3. Damage caused by misuse, abuse, negligent handling, failure to perform required maintenance (e.g., failure to keep the well of the motor base clear of food spills and other debris), or damage due to mishandling in transit.
4. Consequential and incidental damages.
5. Defects caused by repair persons not authorized by SharkNinja. These defects include damages caused in the process of shipping, altering, or repairing the SharkNinja product (or any of its parts) when the repair is performed by a repair person not authorized by SharkNinja.
6. Products purchased, used, or operated outside North America.

How to get service

If your appliance fails to operate properly while in use under normal household conditions within the warranty period, visit ninjakitchen.com/support for product care and maintenance self-help. Our Customer Service Specialists are also available at **1-877-646-5288** to assist with product support and warranty service options, including the possibility of upgrading to our VIP warranty service options for select product categories. So we may better assist you, please register your product online at registeryourninja.com and have the product on hand when you call.

SharkNinja will cover the cost for the customer to send in the unit to us for repair or replacement. A fee of \$20.95 (subject to change) will be charged when SharkNinja ships the repaired or replacement unit.

How to initiate a warranty claim

You must call **1-877-646-5288** to initiate a warranty claim. You will need the receipt as proof of purchase. We also ask that you register your product online at registeryourninja.com and have the product on hand when you call, so we may better assist you. A Customer Service Specialist will provide you with return and packing instruction information.

How state law applies

This warranty gives you specific legal rights, and you also may have other rights that vary from state to state. Some states do not permit the exclusion or limitation of incidental or consequential damages, so the above may not apply to you.



REGISTER YOUR PURCHASE



registeryourninja.com



Scan QR code using mobile device

RECORD THIS INFORMATION

Model Number: _____

Serial Number: _____

Date of Purchase: _____
(Keep receipt)

Store of Purchase: _____

TECHNICAL SPECIFICATIONS

Voltage: 120V-, 60Hz

Power: 650 Watts

SharkNinja Operating LLC

US: Needham, MA 02494

CAN: Ville St-Laurent, QC H4S 1A7

1-877-646-5288

ninjakitchen.com

Illustrations may differ from actual product. We are constantly striving to improve our products, therefore the specifications contained herein are subject to change without notice.

FOODI and NINJA are registered trademarks of SharkNinja Operating LLC.

POWER MIXER is a trademark of SharkNinja Operating LLC.

This product may be covered by one or more U.S. patents. See sharkninja.com/patents for more information.

© 2022 SharkNinja Operating LLC

C1100Series_IB_MP_Mv9



@ninjakitchen