

soundcore H30i User Guide (A3012)

APP

WEARING

CHARGING

POWERING ON AND PAIRING

MULTIPOINT CONNECTION

BUTTON CONTROLS

WIRED LISTENING

RESET

LED LIGHT GUIDE

FIRMWARE UPDATE

SPECS

APP



Google Play and the Google Play logo are trademarks of Google Inc.



Apple and the Apple logo are trademarks of Apple Inc.



Download the soundcore app to customize EQ settings, update firmware, and explore more.
If your headphones cannot connect with the soundcore app, re-install the app or update it to the latest version in your mobile app store.

WEARING

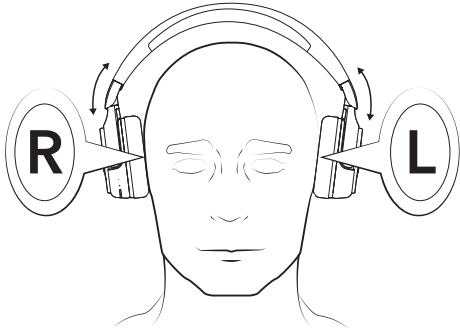

Wear the headphones with the "L" logo on your left ear and "R" logo on your right ear. Adjust the length of the headband for a comfortable fit.

CHARGING

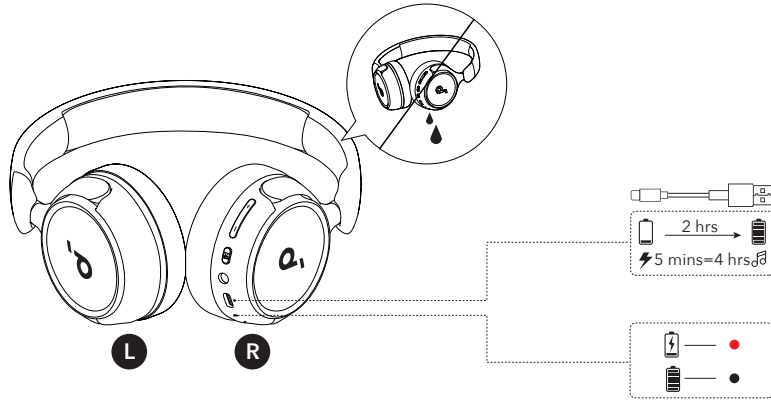

- Fully dry the USB port before charging.
- Do not turn on your headphones while charging.
- Use the supplied USB-C charging cable and a certified charger to prevent any damage.
- When charging, the indicator on the headphones lights up in red.

POWERING ON AND PAIRING

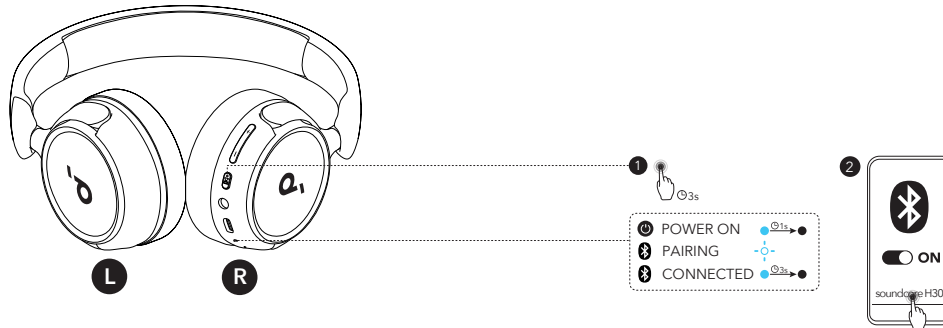

Press and hold the multi-function button for 3 seconds to power on. The headphones will automatically enter Bluetooth pairing mode when connecting for the first time. Select "soundcore H30i" on your device's Bluetooth list to connect. When pairing, the indicator on the headphones flashes blue slowly. After the pairing is successful, the indicator stays on for 3 seconds and then goes off.

Manual Pairing

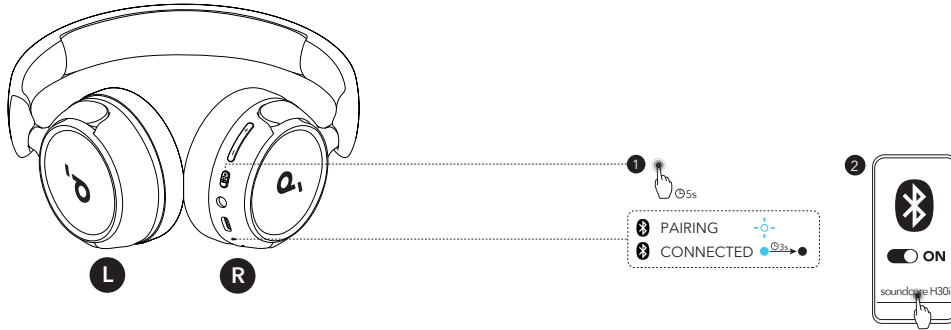

To manually enter Bluetooth pairing mode when the headphones are off, press and hold the power button for 5 seconds until the LED flashes blue.



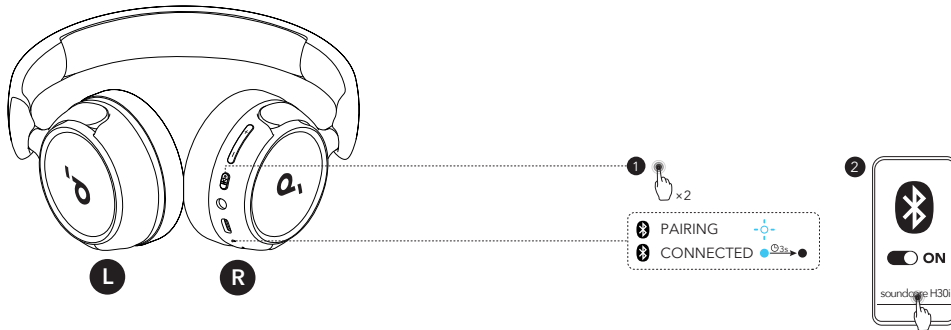





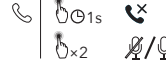
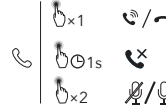
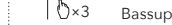
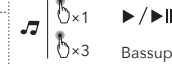
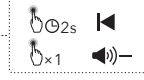
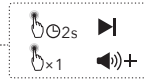
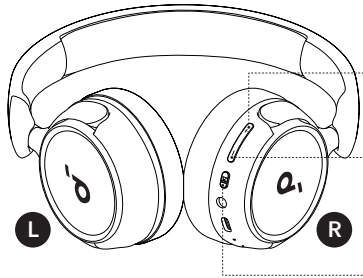



MULTIPOINT CONNECTION



The headphones can connect with two devices at the same time.
When already connected to one device, press the multi-function button twice to pair with another device.

BUTTON CONTROLS



	Power on / off		Press and hold for 3 seconds
	Play / Pause		Press once
	Next track		Press and hold for 2 seconds
	Previous track		Press and hold for 2 seconds
	Volume up		Press once
	Volume down		Press once
	Answer / End a call		Press once
	Reject a call		Press and hold for 1 second
	Mute / Restore the microphone		Press twice
BassUp	Enable Bassup when playing music		Press three times

WIRED LISTENING

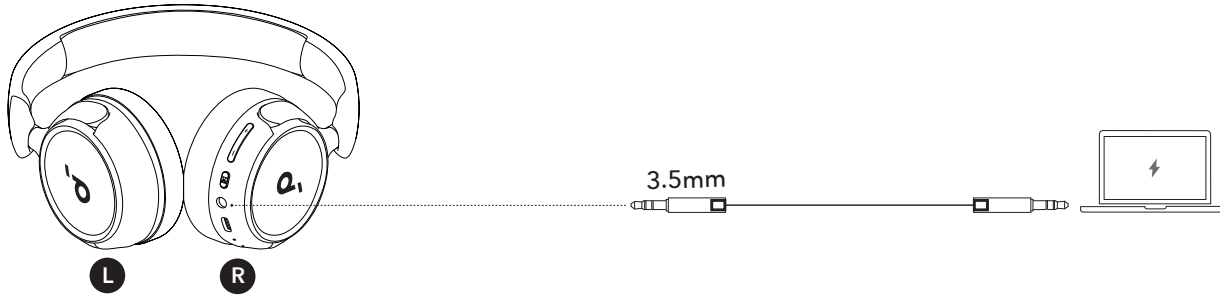

Play audio on an external device by plugging in the supplied 3.5mm AUX cable. Wired listening will automatically turn off Bluetooth mode.

RESET

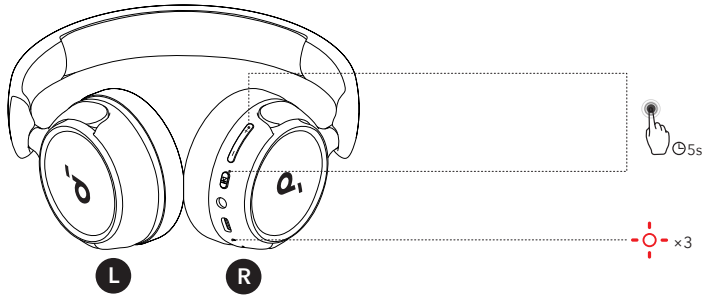



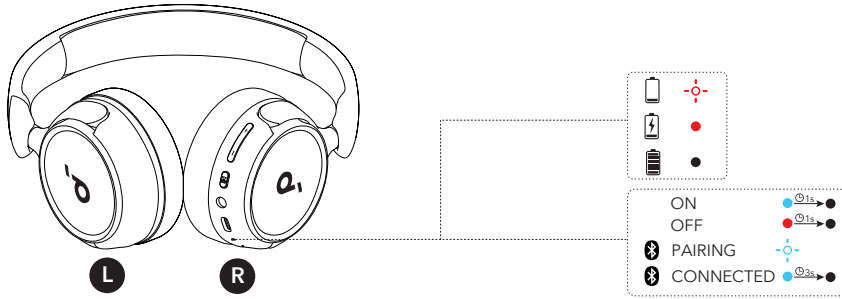

You might need to reset your headphones if you experience connectivity or function issues.

Delete the pairing history from your Bluetooth device first. Press and hold the volume up and multi-function button simultaneously for 5 seconds until the LED flashes red three times.

LED LIGHT GUIDE



	Flashing red
	Flashing blue
	Steady blue
	Press and hold for 2 seconds

FIRMWARE UPDATE

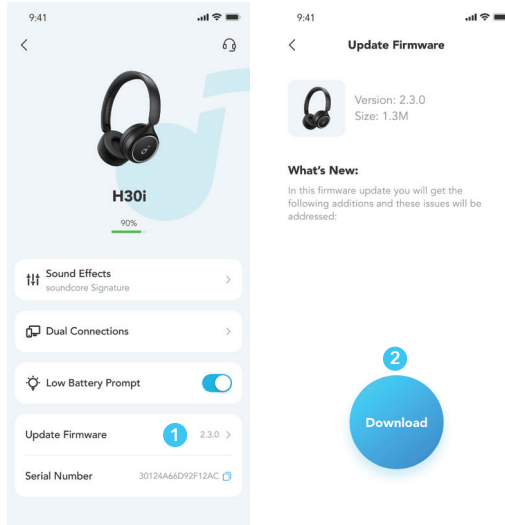

You will be informed once the new version of firmware is detected when you connect the headphones with the app. Ensure the headphones are powered on and connected to a device until the firmware update is complete. During the update, avoid any usage and ensure stable access to the internet.

SPECS

Specifications are subject to change without notice.

Input	5V \pm 1A
Output	5V \pm 0.78A
Battery capacity	800mAh
Charging time	2 hours
Playtime	Up to 70 hours
Driver size	40mm
Frequency response	20Hz - 20kHz
Impedance	16 Ω
Bluetooth version	5.3
Bluetooth range	15m / 49ft