

# OVEN 700 SERIES 30"













CODE ID

30" TOUCH CONTROL SINGLE OVEN - STAINLESS STEEL

**F7SP30S1**



-  **CREACTIVE COOKING SYSTEM**
-  **PIZZA COOKING MODE 590 °F**
-  Dual Convection
-  Self Clean Oven
-  Multi-level cooking
-  1 Telescopic Rack
-  Cool Touch Door
-  TFT Display
-  Meat Probe
-  Fast Pre-Heat
-  Interior Lighting

## OVEN

Creative Touch Control System  
Dual True Convection  
Self-cleaning oven with Multifunction baking  
Black Porcelain enamel interior  
Cool to the touch  
Extra-large baking cavity and viewing area  
3 Halogen lights for flawless visibility  
Total capacity 123 lt  
Total capacity 4,34 cu. ft.  
2 chromed racks  
1 telescopic rack  
Enameled Broiler Pan  
Lock Keys  
Door Lock

## OVEN FUNCTIONS

Bake (cooking group)  
Broil  
Convection (cooking group)  
Keep Warm (cooking group)  
Recipes  
Classic Pizza Function 590°F  
Preset default temperature  
Preheat (display instantaneous temperature)  
Fast Preheat Mode  
Sabbath Mode  
Setting Temperature °C/°F  
Setting Weight Kg/lb  
Event Logs (for Service)  
Meat Probe  
Self-Clean

## OPTIONAL ACCESSORIES

FMTR630      30" Telesc. Rack

# DISTINTO

## 30" TOUCH CONTROL SINGLE OVEN

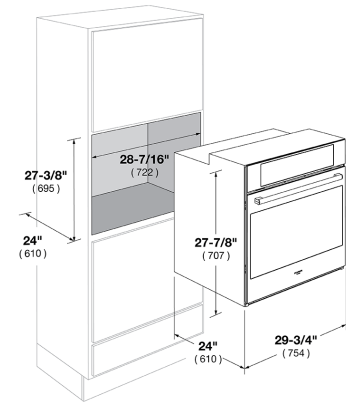

| CODE ID                                    | 30" TOUCH CONTROL SINGLE OVEN<br>F7SP30S1                          |                                   |
|--|--|-----------------------------------|
| Series                                     | 700  |                                   |
| Finish                                     | Stainless Steel  |                                   |
| <b>CONTROL PANEL</b>                       |  |                                   |
| Control Type                               | Creative Electronic Touch Control                                  |                                   |
| Display: Clock - Temperature - Function    | TFT 3.5"   |                                   |
| Language                                   | English (USA) / English (UK) / French / Spanish / Italian / German |                                   |
|  | Control Interface  | Chime Volume Setting              |
|  | Full Touch: Functions -<br>Recipes - Settings Menu                 | Date Format                       |
|  | Brightness Setting   | Demo Mode                         |
| <b>OVEN</b>                                |  |                                   |
| Type                                       | Dual True Convection   |                                   |
| Temperature Regulation                     | Electronic Control (min/max 170/550°F - 75/290°C)                  |                                   |
| <b>OVEN FUNCTIONS</b>                      |  |                                   |
|  | Pyrolytic Self-Clean   | Broil                             |
|  | True Convection  | Dehydrate                         |
|  | Convection Broil   | Thaw (Defrost)                    |
|  | Convection Roast   | Proof (Warm)                      |
|  | Pizza (Lower Convection)   | Keep warm (Warm Plus)             |
|  | Bake   | Oven Lights                       |
| <b>ELECTRIC OVEN FEATURES</b>              |  |                                   |
|  | Preset default temperature   | Display instantaneous temperature |
|  | Child Door Lock  | Control Display Lock              |
|  | Sabbath Mode   | 12/24 Hour Clock Formats          |
|  | Automatic Fast Preheat   | Temperature Display °C/°F         |
|  | Meat Probe   | Event Logs (for Service)          |
| <b>OVEN DOOR(S)</b>                        |  |                                   |
| Oven Glass Window                          | Large See Through Glass  |                                   |
| Door Cooling System                        | 4 Heat Resistant Glasses   |                                   |
| Door Hinges                                | Heavy Duty Steady Tilt   |                                   |
| <b>OVEN CAVITY</b>                         |  |                                   |
| Total Capacity ( lt )                      | 123  |                                   |
| Total Capacity ( cu. ft. )                 | 4,34   |                                   |
| Cavity Enamel Colour                       | Black  |                                   |
| Rack Positions                             | 6  |                                   |
| Oven Lights                                | 3x20W Halogen  |                                   |
| <b>HEATING ELEMENTS (@240V)</b>            |  |                                   |
| Broil Upper Heating Element                | 3500 W   |                                   |
| Upper Auxiliary Element                    | 1032 W   |                                   |
| Concealed Bake Lower Heating Element       | 3000 W   |                                   |
| Convection Element                         | 2 x 1300 W   |                                   |
| <b>OVEN ACCESSORIES</b>                    |  |                                   |
| Chromed Racks                              | 2  |                                   |
| Enameled Broiler Pan (basin + anti splash) | 1  |                                   |
| Telescopic Chromed Rack                    | 1  |                                   |
| <b>DIMENSIONS/WEIGHT</b>                   |  |                                   |
| Overall dim - Width                        | 29 - 11/16"  | (754 mm)                          |
| Overall dim - Height                       | 27 - 7/8"  | (707 mm)                          |
| Overall dim - Depth                        | 24"  | (610 mm)                          |
| Cut-out - Width                            | 28 - 7/16"   | (722 mm)                          |
| Cut-out - Height (min)                     | 27 - 3/8"  | (695 mm)                          |
| Cut-out - Depth (min)                      | 23 - 1/4"  | (590 mm)                          |
| Gross Weight                               | 183 lbs  | (83 kg)                           |
| <b>POWER / RATINGS (208/240 V, 60 HZ)</b>  |  |                                   |
| kW / Amps rating at 120-240V, 60Hz         | 3.70kW - 15.4A   |                                   |
| kW / Amps rating at 120-208V, 60Hz         | 3.50kW - 16.8A   |                                   |
| Power Cable                                | Conduit  |                                   |
| <b>INSTRUCTIONS FOR USE</b>                |  |                                   |
| Use & Care Manual / Installation Manual    | English / French / Spanish   |                                   |