

ITEM: 930195

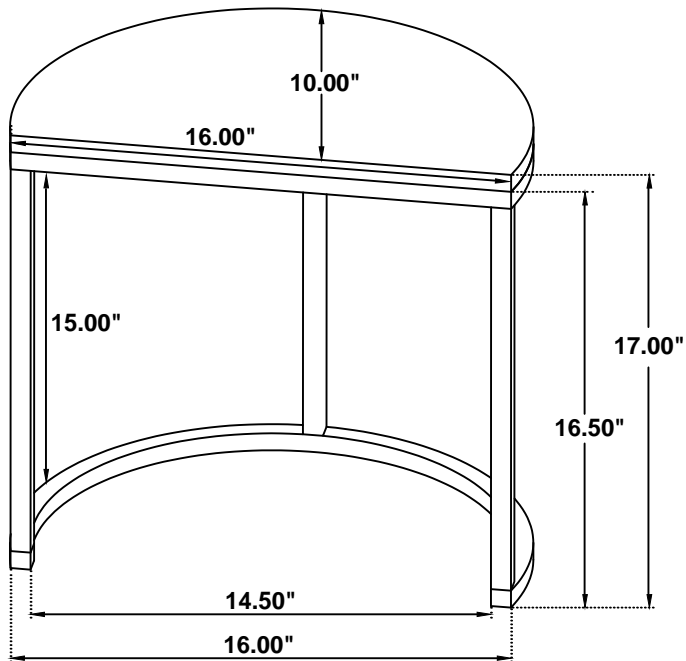
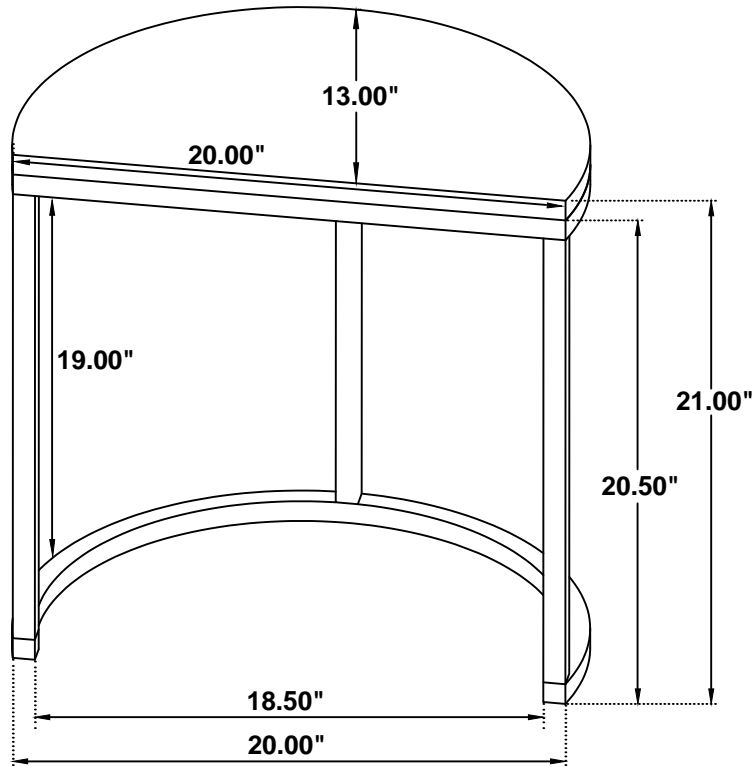

Note : Dimension tolerance $\pm 5\%$