



Scan to see the online manual.



# OWNER'S MANUAL

# MICROWAVE OVEN

---

Read this owner's manual thoroughly before operating the appliance and keep it handy for reference at all times.

**ENGLISH**

MSER0990\*



MFL71740602  
Rev.03\_082124

[www.lg.com](http://www.lg.com)

Copyright © 2024 LG Electronics. All Rights Reserved

---

# TABLE OF CONTENTS

## 3 IMPORTANT SAFETY INSTRUCTIONS

---

- 3 READ ALL INSTRUCTIONS BEFORE USE
- 3 WARNING

## 7 INSTALLATION

---

- 7 Product Overview
- 7 Installation Requirements

## 10 OPERATION

---

- 10 Control Panel
- 11 Before Use
- 12 Quick Start and Stop
- 12 Manual Cooking
- 12 Cooking Mode
- 15 Cookware Guide
- 17 Cooking Guide

## 19 SMART FUNCTIONS

---

- 19 LG ThinQ Application
- 19 Smart Diagnosis™ Feature

## 20 MAINTENANCE

---

- 20 Cleaning

## 21 TROUBLESHOOTING

---

- 21 FAQs
- 22 Before Calling for Service

## 23 LIMITED WARRANTY

---

- 23 USA

### **PRECAUTIONS TO AVOID POSSIBLE EXPOSURE TO EXCESSIVE MICROWAVE ENERGY**

- (a) Do not attempt to operate this oven with the door open since open-door operation can result in harmful exposure to microwave energy. It is important not to defeat or tamper with the safety interlocks.
- (b) Do not place any object between the oven front face and the door or allow soil or cleaner residue to accumulate on sealing surfaces.
- (c) Do not operate the oven if it is damaged. It is particularly important that the oven door close properly and that there is no damage to the: (1) Door (bent), (2) hinges and latches (broken or loosened), (3) door seals and sealing surfaces.
- (d) The oven should not be adjusted or repaired by anyone except properly qualified service personnel.

# IMPORTANT SAFETY INSTRUCTIONS

## READ ALL INSTRUCTIONS BEFORE USE

### Safety Messages

**Your safety and the safety of others are very important.**

We have provided many important safety messages in this manual and on your appliance. Always read and follow all safety messages.



This is the safety alert symbol.

This symbol alerts you to potential hazards that can kill or injure you and others. All safety messages will follow the safety alert symbol and either the word **WARNING** or **CAUTION**.

These words mean:



#### **WARNING**

You may be killed or seriously injured if you do not follow instructions.



#### **CAUTION**

You may be injured or cause damage to the product if you do not follow instructions.

All safety messages will tell you what the potential hazard is, tell you how to reduce the chance of injury, and tell you what may happen if the instructions are not followed.

## WARNING

### **WARNING**

- To reduce the risk of explosion, fire, death, electric shock, injury or scalding to persons when using this product, follow basic precautions, including the following:

### Technical Safety

- This appliance is not intended for use by persons (including children) with reduced physical, sensory or mental capabilities, or lack of experience and knowledge, unless they have been given supervision or instruction concerning use of the appliance by a person responsible for their safety. Children should be supervised to ensure that they do not play with the appliance.
- To reduce the risk of burns, electric shock, fire, injury to persons or exposure to excessive microwave energy when using the microwave oven, read all instructions before using the appliance.
- Children must not be allowed to play with accessories or hang down from the door or any part of the oven. Doing so can cause serious injury and damage. As with any appliance, close supervision is necessary when used by children.
- Read and follow the specific **PRECAUTIONS TO AVOID POSSIBLE EXPOSURE TO EXCESSIVE MICROWAVE ENERGY** found on page 2.
- This appliance must be grounded. Connect only to properly grounded outlet. See **“GROUNDING INSTRUCTIONS”** found on **Installation Requirements** section.
- Use this appliance only for its intended use as described in the manual. Do not use corrosive chemicals or vapors in this appliance. This type of oven is specifically designed to heat, cook, or dry food. It is not designed for industrial or laboratory use.
- To avoid electric shock:
  - Do not operate this appliance if it has a damaged cord or plug, if it is not working properly or if it has been damaged or dropped.

## 4 IMPORTANT SAFETY INSTRUCTIONS

---

- Do not immerse cord or plug in water. Keep cord away from heated surfaces.
- Do not let cord hang over edge of table or counter.
- To reduce the risk of fire in the oven cavity:
  - Do not overcook food. Carefully attend appliance when paper, plastic, or other combustible materials are placed inside the oven to facilitate cooking.
  - Remove wire twist-ties from paper or plastic bags before placing bag in oven.
  - If materials inside the oven ignite, keep oven door closed, turn oven off, and disconnect the power cord, or shut off power at the fuse or circuit breaker panel.
  - Do not use the cavity for storage purposes. Do not leave paper products, cooking utensils, or food in the cavity when not in use.
- Install or locate this appliance only in accordance with the provided installation instructions.
- Some products such as whole eggs and sealed containers – for example, closed glass jars – are able to explode and should not be heated in this oven.
- Liquids, such as water, coffee, or tea are able to be overheated beyond the boiling point without appearing to be boiling. Visible bubbling or boiling when the container is removed from the microwave oven is not always present.
- **THIS COULD RESULT IN VERY HOT LIQUIDS SUDDENLY BOILING OVER WHEN THE CONTAINER IS DISTURBED OR A SPOON OR OTHER UTENSIL IS INSERTED INTO THE LIQUID.**

To reduce the risk of injury to persons:

- Do not overheat the liquid. Stir the liquid both before and halfway through heating it.
- Do not use straight-sided containers with narrow necks. Use extreme care when inserting a spoon or other utensil into the container.
- After heating, allow the container to stand in the microwave oven for a short time before removing the container.
- Do not cover or block any openings on the appliance.
- Do not store this appliance outdoors. Do not use this product near water - for example, near a kitchen sink, in a wet basement, near a swimming pool, or similar locations.
- This appliance should be serviced only by qualified service personnel. Contact the nearest authorized service facility for examination, repair, or adjustment.
- When cleaning surfaces of door and oven that comes together on closing the door, use only mild, nonabrasive soaps or detergents applied with a sponge or soft cloth.
- **HOT CONTENTS CAN CAUSE SEVERE BURNS. DO NOT ALLOW CHILDREN TO USE THE MICROWAVE.** Use caution when removing hot items.

## Operation

- Do not use this oven for commercial purposes. It is made for household use only.
- Do not run the oven while it is empty.
- If your oven is dropped or damaged, have it thoroughly checked by a qualified service technician before using it again.
- Take care when the door is opened to avoid injury.
- To avoid improperly cooking some foods:
  - Do not heat any type of baby bottle or baby food. Uneven heating may occur and possibly cause personal injury.
  - Do not heat small-necked containers, such as syrup bottles.
  - Do not deep-fat fry in the microwave oven.
  - Do not attempt home canning in the microwave oven.
- Do not use the oven for the purpose of dehumidification (for example, operating the microwave oven with wet newspapers, clothes, toys, electric devices, plants, soil, pets or any other living matter inside it).

The oven must only be used for heating or cooking food. The results of misuse can include safety risks such as fire, burns, or death due to electric shock.

- The appliance and its accessible parts become hot during use. Care should be taken to avoid touching heating elements inside the oven. Children must be kept away unless continuously supervised.
- Do not use recycled paper products. They may contain impurities which may cause sparks and/or fires when used in cooking.
- The door or the outer surface may get hot when the appliance is operating.
- Liquids heated in certain shaped containers (especially cylindrical-shaped containers) may become overheated. The liquid may splash out with a loud noise during or after heating or when adding ingredients (instant coffee, etc.), resulting in harm to the oven and possible injury. In all containers, for best results, stir the liquid several times before heating. Always stir liquid several times between reheatings.

## Maintenance

- If the door or door seals are damaged, the oven must not be operated until it has been repaired by an authorized service person.
- The oven should be cleaned regularly and any food deposits should be removed. Failure to maintain the oven in a clean condition could lead to deterioration of the surface that could adversely affect the life of the appliance and possibly result in a hazardous situation.
- Do not rinse trays and racks by placing them in water immediately after cooking. This may cause breakage or damage. Improper use could result in damage to the oven.
- Oversized food or oversized metal utensils should not be inserted in a microwave oven as they may create a fire or risk of electric shock.
- Do not clean with metal scouring pads. Pieces can burn off the pad and touch electrical parts involving a risk of electric shock.
- Do not store any materials, other than manufacturer's recommended accessories, in this oven when not in use.
- Do not cover racks or any other part of the oven with metal foil. This will cause overheating of the oven.
- Do not allow water to spill into the ventilation openings to prevent damage to the internal working parts of the oven. Doing so may cause a fire or create a risk of electric shock.

## Radio/TV/Wireless Equipment Interference

- Operating the microwave oven near equipment-such as a radio, TV, wireless LAN, Bluetooth devices, medical equipment, or wireless equipment which uses the same frequency, may cause interference. This interference is not an indication of a defect in the product or its operation. The product is safe to use.
- Do not use medical equipment near the microwave oven, as the interference could affect the medical equipment's operation.
- When there is interference, it may be reduced or eliminated by taking the following measures:
  - Clean the door and the sealing surfaces of the oven.
  - Reorient the receiving antenna of the radio, TV, Bluetooth, or other equipment.
  - Relocate the microwave oven in relation to the radio, TV, Bluetooth, or other equipment.
  - Move the microwave oven away from the receiver.
  - Plug the microwave oven into a different outlet so that the microwave oven and receiver are on different branch circuits

## **FEDERAL COMMUNICATIONS COMMISSION RADIO FREQUENCY INTERFERENCE STATEMENT (U.S.A. ONLY)**

- This equipment generates and uses ISM frequency energy and if not installed and used properly, that is in strict accordance with the manufacturer's instructions, may cause interference to radio and television reception. It has been type tested and found to comply with limits for ISM Equipment pursuant to part 18 FCC Rules, which are designed to provide reasonable protection against such interference in a residential installation. However, there is no guarantee that interference will not occur in a particular installation. If this equipment does cause interference to radio or television reception, which can be determined by turning the equipment off and on, the user is encouraged to try to correct the interference by one or more of the following:
  - Reorient or relocate the receiving antenna of the radio or television.
  - Increase the separation between the equipment and receiver.
  - Connect the equipment into an outlet on a circuit different from that to which the receiver is connected.
  - Consult the dealer or an experienced radio/TV technician for help.
- The manufacturer is not responsible for any radio or TV interference caused by unauthorized modification to this equipment. It is the responsibility of the user to correct such interference.

**SAVE THESE INSTRUCTIONS**

# INSTALLATION

## Product Overview

The appearance or components of the appliance may differ from model to model.

### Front View

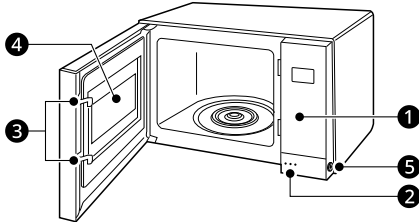

- ① Control Panel
- ② Door Open Button
- ③ Safety Door Lock System
- ④ Window
- ⑤ Safety Lock Button

### Accessories

Accessories will vary depending on the model purchased.

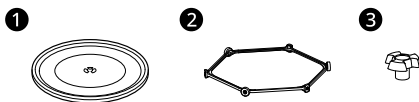

- ① Glass Tray
- ② Rotating Ring
- ③ Shaft

### ⚠ WARNING

- Do not operate the oven when it is empty or without the glass tray. It is best to leave a glass of water in the oven when not in use. The water will safely absorb all microwave energy, if the oven is accidentally started.

### ⚠ CAUTION

- To avoid risk of personal injury or property damage, do not use stoneware, metal cookware, or metal rimmed cookware in the oven.

### NOTE

- This microwave oven is designed for household use only. It is not recommended for commercial use.
- Do not cook food for too long. The microwave oven can be damaged.
- A beep sounds each time you press a key. A melody signals the end of a timer or a cooking cycle.

## Specifications

### MSER0990\* Model

- **Power Supply:** 120 V AC, 60 Hz
- **Rated Power Consumption:** 1040 W
- **Microwave Output:** Max. 1000 W<sup>†</sup>
- **Frequency:** 2450 MHz
- **Rated Current:** 8.7 A
- **Dimensions (W x H x D):** 18 3/4" x 10 11/16" x 14" (47.6 x 27.2 x 35.6 cm)
- **Oven Cavity Dimensions (W x H x D):** 12 11/16" x 9" x 13 3/16" (32.2 x 22.8 x 33.5 cm)
- **Capacity of Oven Cavity:** 0.9 cu.ft. (0.02 m<sup>3</sup>)

<sup>†</sup> IEC 60705 RATING STANDARD. Specifications are subject to change without prior notice.

## Installation Requirements

### Installation Location

Place the microwave oven on a flat surface. Free airflow around the oven is important. Allow at least 4 inches of clearance around the top, sides, and back of the oven for proper ventilation.

- Do not place oven above a gas or electric range.

### Electrical Requirements

The oven is designed to operate on a Standard 120 V/60 Hz household outlet. Be sure the circuit is at least 15 A or 20 A and the microwave oven is the only appliance on the circuit. It is not designed for 50 Hz or any circuit other than a 120 V/60 Hz circuit. No other electrical appliances or lighting circuits should be on this line. If in doubt, consult a licensed electrician.

## Voltage Warning

The voltage used at the wall socket must be the same as specified on the oven name plate located on the back or on the side of the control panel of the oven. Using a higher voltage is dangerous and may result in a fire or other type of accident causing oven damage. Low voltage will cause slow cooking. If the microwave oven does not perform normally in spite of proper voltage, unplug and reconnect the power cord.

## Do Not Block Air Vents

All air vents should be kept clear during cooking. If air vents are covered during oven operation the oven may overheat. To prevent damage to the oven, a sensitive safety device detects overheating and automatically turns the oven off. The oven cannot be used until it has cooled sufficiently.

## Grounding Instructions

This appliance must be grounded. In the event of an electrical short circuit, grounding reduces the risk of electric shock by providing an escape wire for the electric current. This appliance is equipped with a cord having a grounding wire with a grounding plug. The plug must be plugged into an outlet that is properly installed and grounded.

- Consult a qualified electrician or service person if the grounding instructions are not completely understood, or if doubt exists as to whether the appliance is properly grounded.
  - Use of an extension cord is not recommended. If the power supply cord is too short, have a qualified electrician or service person install an outlet near the appliance.
  - If it is necessary to use an extension cord, use only a 3-wire extension cord that has a 3-blade grounding plug, and a 3-slot socket that will accept the plug on the appliance. The marked rating of the extension cord must be equal to or greater than the electrical rating of the appliance.
- Ensure proper ground exists before use.

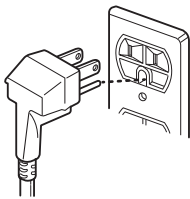

- Keep the electrical power cord dry and do not pinch or crush it in any way.

## ⚠ WARNING

- Improper use of grounding can result in a risk of electric shock.

## NOTE

- A short power supply cord is provided to reduce the risks resulting from becoming entangled in or tripping over a longer cord.
- Longer cord sets or extension cords are available and may be used if care is exercised in their use.
- If a long cord or extension cord is used, (1) the marked electrical rating of the cord set or extension cord must be at least as great as the electrical rating of the appliance, (2) the extension cord must be a grounding-type 3-wire cord, and (3) the longer cord should not be draped over a counter or table where children could pull on it, or located where it could present a trip hazard.

## Safety Lock Guide

For safety, this microwave requires a 2-step process to open the door. This safety door lock feature reduces the risks to young children by reducing the likelihood of them handling hot food and beverage items.

- Hot contents can cause severe burns. Do not allow children to use the microwave.
- All persons should use caution when removing hot items from the microwave oven.

When the Safety Lock is enabled, you must complete the 2-step process each time you open the door.

If there are no young children in your household, or disabilities make it difficult for adults to operate the 2-step door latch, refer to the instructions below to disable the safety lock feature and convert the door to a 1-step push button latch.

## Opening Door with Safety Lock Enabled

Side Button	Front Button



- 1 Use one finger to locate and press the safety lock button on the right side of the door.
- 2 While pressing the lock button, use your thumb to press the door latch release button on the front of the door.

### Disabling the Safety Lock

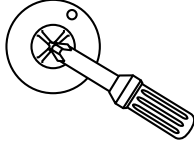
Safety Lock On (default)	Safety Lock Off
<p style="text-align: center;">Lock    Unlock</p> 	<p style="text-align: center;">Lock    Unlock</p> 

- 1 Locate the lock button on the side of the control panel.
- 2 Using a Phillips screwdriver, gently press the button in.
- 3 Rotate the screwdriver clockwise to the "**Unlock**" position. Do not over-tighten.

#### NOTE

- After it's rotated, the button will stay in the pressed-in "**Unlock**" position. To return it to the factory default position, use a Phillips screwdriver to rotate the lock button counterclockwise to the "**Lock**" position. The lock button will spring back up.
- Push in fully before turning to disengage.

# OPERATION

## Control Panel

The actual control panel may differ from model to model.

### Control Panel Features

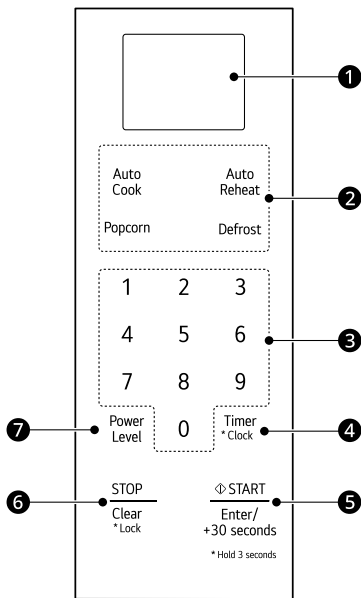

### 6 STOP/Clear/Lock

- Press **STOP/Clear** to stop the oven or clear all entries.
- Press and hold **STOP/Clear** for 3 seconds to lock the control panel.

### 7 Power Level

Press **Power Level** to set a cooking power.

### 1 Display

Shows the time of day, cooking time settings, and selected cooking functions.

### 2 Auto Cook Mode

Press the buttons to select preprogrammed cook and defrost settings for popular food items.

### 3 Number Keys

Press the number keys to set cooking time, power level, quantity, or weight.

### 4 Timer/Clock

- Press **Timer/Clock** to use your microwave oven as a kitchen timer.
- Press and hold **Timer/Clock** for 3 seconds to set the time of day.

### 5 START/Enter

- Press **START/Enter** to start the oven or enter amounts.
- Press **START/Enter** to cook at 100% cook power for 30 seconds.
- Press **START/Enter** during cooking to increase cook time by 30 seconds. (Add up to 99 minutes and 59 seconds)

## Before Use

### Setting the Clock

When the oven is plugged in for the first time or when power resumes after a power interruption, the clock defaults to the 12-hour clock mode and **12H** appears in the display. You can set the time of day or switch to the 24-hour clock mode.

- 1** Press **START/Enter** to confirm the **12H** clock display.
  - To switch between the 12-hour and 24-hour clock modes, press **Timer/Clock**.
- 2** Press the number keys to set the desired hour and minutes, and press **START/Enter**.

#### NOTE

- To reset the clock, unplug and reconnect the power cord. Or press and hold **Timer/Clock** until **12H** appears in the display (approximately 3 seconds).
- To keep the time of day from appearing in the display, press **STOP/Clear** after plugging in the oven.
- When the oven is not in use, the display turns off to save energy, unless the time of day is set to show in the display.

### Child Lock

Use this safety feature to lock the control panel before cleaning the oven or to prevent children from unsupervised use of the oven.

#### Setting Child Lock to ON

- 1** Press **STOP/Clear**.
- 2** Press and hold **STOP/Clear** until **Loc** appears in the display (approximately 3 seconds).

#### Canceling Child Lock

Press and hold **STOP/Clear** until **Loc** disappears in the display (approximately 3 seconds).

#### NOTE

- If set, the time of day reappears in the display after 1 second.

- If the oven is locked, **Loc** appears in the display when any key is pressed.
- Unlock the oven to resume normal use.

### Kitchen Timer

The Timer function serves as an extra kitchen timer. It chimes when the set time runs out. It does not start or stop cooking.

#### Setting Timer for 3 Minutes

- 1** Press **Timer/Clock**.
- 2** Press the number keys to set the time (**3**, **0**, and **0**), and press **START/Enter**.
  - The oven starts immediately and the time counts down in the display.

#### Canceling the Timer

Press **Timer/Clock**.

#### NOTE

- When the time is over a melody sounds and **End** displays. Press **STOP/Clear**.

### Weight Conversion

Most food weights are given in pounds and ounces. If using pounds, food weights must be entered into auto defrost in pounds and tenths of pounds (decimals). Use the following chart to help you convert food weights to decimals.

- |                             |                     |
|-----------------------------|---------------------|
| • 1.6 oz. = 0.1 lb          | • 9.6 oz. = 0.6 lb  |
| • 3.2 oz. = 0.2 lb          | • 11.2 oz. = 0.7 lb |
| • 4.8 oz. = 0.3 lb          | • 12.8 oz. = 0.8 lb |
| • 6.4 oz. = 0.4 lb          | • 14.4 oz. = 0.9 lb |
| • 8.0 oz. = 0.5 lb (1/2 lb) | • 16.0 oz. = 1.0 lb |

### Microwave Power Levels

This microwave oven is equipped with 10 power levels to give you maximum flexibility and control over cooking.

- When operating at 100 - 80 % power levels for prolonged periods, the output power will be

## 12 OPERATION

reduced gradually to help prevent the unit from electrically overheating.

Power Level	Use
<b>P-HI</b> (100 %)	<ul style="list-style-type: none"><li>• Boiling water.</li><li>• Browning ground beef.</li><li>• Making candy.</li><li>• Cooking whole poultry, poultry pieces, fish &amp; vegetables.</li><li>• Cooking tender cuts of meat.</li></ul>
<b>P-90</b> (90%)	<ul style="list-style-type: none"><li>• Reheating rice, pasta &amp; vegetables.</li></ul>
<b>P-80</b> (80%)	<ul style="list-style-type: none"><li>• Reheating prepared foods quickly.</li><li>• Reheating sandwiches.</li></ul>
<b>P-70</b>	<ul style="list-style-type: none"><li>• Cooking egg, milk and cheese dishes.</li><li>• Cooking cakes and breads.</li><li>• Melting chocolate.</li></ul>
<b>P-60</b>	<ul style="list-style-type: none"><li>• Cooking veal.</li><li>• Cooking whole fish.</li><li>• Cooking puddings and custard.</li></ul>
<b>P-50</b>	<ul style="list-style-type: none"><li>• Cooking ham, whole poultry and lamb.</li><li>• Cooking rib roast and sirloin tip.</li></ul>
<b>P-40</b>	<ul style="list-style-type: none"><li>• Thawing meat, poultry and seafood.</li></ul>
<b>P-30</b>	<ul style="list-style-type: none"><li>• Cooking less tender cuts of meat.</li></ul>
<b>P-20</b>	<ul style="list-style-type: none"><li>• Taking chill out of fruit.</li><li>• Softening butter.</li></ul>
<b>P-10</b>	<ul style="list-style-type: none"><li>• Keeping casseroles and main dishes warm.</li><li>• Softening butter and cream cheese.</li></ul>
<b>P-00</b>	<ul style="list-style-type: none"><li>• Standing time.</li></ul>

## Quick Start and Stop

### Using Quick Start

The Quick Start feature allows you to set 30-second intervals of High power cooking with each press of the **Start/Enter** button.

### Cooking for 2 Minutes on High Power

- 1 Press **STOP/Clear**.

- 2 Press **START/Enter** four times.

- The oven starts immediately and the time counts down in the display.
- Press **START/Enter** repeatedly to extend the cook time by 30 seconds every time the button is pressed.

### Interrupting Cooking

- To stop the oven during a cycle, open the door.
- To restart cooking, close the door and press **START/Enter**.
- To stop cooking and clear the remaining cook time, open the door and press **STOP/Clear**.

## Manual Cooking

### Using Manual Cooking

When not using the auto cooking functions, the cooking time and power level are set manually.

### Cooking for 5 Minutes, 30 Seconds at 80% Power

- 1 Press **STOP/Clear**.
- 2 Press the number keys to set the cook time (**5:30**), and press **Power Level**.
- 3 Press the number **8** key to select power level 8, and press **START/Enter**.
  - When cooking is complete, a chime sounds and **End** appears in the display window. **End** remains in the display and the chime repeats every minute until the door is opened, or any button is pressed.

### NOTE

- If a power level is not selected, the oven defaults to 100% power.

## Cooking Mode

Cook your favorite foods without having to select cooking times and power levels.

## Auto Cook Mode

This feature is only available on some models. Auto Cook has preprogrammed settings to automatically cook certain foods. Select the desired food item, and enter the amount. The oven automatically cooks the item.

- 1 Press **STOP/Clear**. Press **Auto Cook**.
- 2 Use the number keys or press **Auto Cook** to enter the desired menu code from the **Auto Cook Menu**, and press **START/Enter**.
- 3 Press the number keys to set the weight, and press **START/Enter**.

## Auto Cook Menu

Refer to the information below to set the desired code and weight.

### 1 Bacon (2 - 4 slices)

- Place bacon slices on a microwave bacon rack. Or use a dinner plate lined with paper towels.

### 2 Fresh Vegetable (1 - 4 cups)

- Place in a microwaveable bowl or casserole. Add water and cover with vented plastic wrap.
  - **1-2 cups**: add 2 tbsp water.
  - **3-4 cups**: add 4 tbsp water.
- Standing time: 3 minutes

### 3 Frozen Entree (10 - 40 oz.)

- Remove from outer display package. Slit cover. If not in microwave-safe container, place on a microwaveable plate and cover with vented plastic wrap.
- Standing time: 3 minutes

### 4 Frozen Vegetable (1 - 4 cups)

- Place in a microwaveable bowl or casserole. Add water and cover with vented plastic wrap.
  - **1-2 cups**: add 2 tbsp water.
  - **3-4 cups**: add 4 tbsp water.
- Standing time: 3 minutes

## 5 Oatmeal (1 - 2 servings)

- Combine water or milk, salt and oats in large microwave-safe bowl. Cover with vented plastic wrap.
  - **1 serving**: 0.5 cup (40 g) oats, 1 cup (230 g) water or milk, dash of salt.
  - **2 servings**: 1 cup (80 g) oats, 1.5 cup (345 g) water or milk, 1/8 tsp salt.
- Standing time: 3 minutes

## 6 Potato (1 - 4 ea)

- Pierce skin with a fork and place on paper towel. Do not cover.
- Standing time: 5 minutes

## 7 Rice (0.5 - 2 cups, 96 g - 384g)

- Use a large, deep microwave-safe bowl (3 qt./3 L).
- Combine 1 part rice to 2 parts water. Cover with vented plastic wrap.
- Standing time: 5 - 10 minutes.

## Auto Reheat Mode

This feature reheats single servings of previously cooked foods or a plate of leftovers.

- 1 Press **STOP/Clear**. Press **Auto Reheat**.
- 2 Use the number keys or press **Auto Reheat** to enter the desired menu code from the **Auto Reheat Menu**, and press **START/Enter**.
- 3 Press the number keys to set the weight, and press **START/Enter**.

### NOTE

- Do not use recycled paper products in the microwave oven. They sometimes contain impurities that cause arcing and sparking.

## Auto Reheat Menu

Refer to the information below to set the desired code and weight.

### 1 Beverage (1 - 2 cups, 240 ml per cup)

- Use a mug or microwave-safe cup. Do not cover.

## 14 OPERATION

---

- Stir after reheating. (Be careful! The beverage will be very hot. Sometimes liquids heated in cylindrical containers will splash out unexpectedly when the cup is moved.)

### 2 Casserole (10 - 20 oz)

- Place food in a bowl or casserole or on a plate. Cover with vented plastic wrap.
- Standing time: 3 minutes

### 3 Dinner Plate (1 serving)

- Place food in a bowl or casserole or on a plate. Cover with vented plastic wrap.
- Standing time: 3 minutes

### 4 Pie (10 - 20 oz)

- Cut leftover pie into pieces. Place food on a microwave-safe dish.

### 5 Pizza (1 - 3 slices)

- Place on paper towel on a microwave safe plate.
- This is a reheat function for leftover pizza. Do not use to cook pizza.

## Popcorn Mode

Prepare microwave popcorn simply and easily, one bag at a time.

- Popcorn only uses HI (100%) power.
- The popping time counts down in the display.
- When the cook time ends, a melody sounds and **End** appears in the display. The oven turns off automatically.
- Place one bag only (50 - 100g) of prepackaged microwave popcorn on a microwave-safe / oven-safe dish on the turntable. The package should be at room temperature.

**1** Press **STOP/Clear**.

**2** Press **Popcorn** and press **START/Enter**.

---

### CAUTION

- Never use a brown paper bag for popping corn or attempt to pop leftover kernels.
- Do not pop popcorn, except in a microwave-safe container or commercial packages designed for microwave ovens.
- Never try to pop popcorn in a paper bag that is not microwave-approved.

- Overcooking may result in the popcorn being burnt and smoking badly.
  - Do not repop unpopped kernels in the microwave.
  - Do not reuse popcorn bags. Overcooking can result in an oven fire.
  - Listen while corn pops. Stop oven when popping slows to 2-3 seconds between pops.
  - Do not leave microwave unattended while popping corn.
  - Follow directions on bag.
  - When popping prepackaged popcorn, place the bag carefully in the oven so it does not touch the walls as it rotates. Fold the ends of the bag up and toward the center of the bag.
  - If popcorn bag size is not known, follow manufacturer's instructions and do not use this feature.
  - Do not use Popcorn button in combination with any other feature buttons.
  - Do not attempt to reheat or cook any unpopped kernels.
  - Prepare only one bag at a time.
  - Do not use popcorn popping devices in microwave oven with this feature.
- 

## Popcorn Menu

Refer to the information below to set the desired code and weight.

### Pop Popcorn (3.5 oz.)

- Pop only one package at a time. For best results, use a fresh bag of popcorn. Place a bag of prepackaged microwave popcorn on the center of the glass tray.

## Defrost Mode

The oven has 4 preset defrost cycles. The Defrost Menu shows the suggested defrost cycle for various foods. This defrost function conveniently chimes during the cycle to remind you to check, turn over, separate, or rearrange the food.

**1** Press **STOP/Clear**. Press **Defrost**.

**2** Use the number keys or press **Defrost** to enter the desired menu code from the **Defrost Menu**, and press **START/Enter**.

- 3** Press the number keys to set the weight, and press **START/Enter**.
- At the chime, open the oven door and turn the food over. Remove any food that has thawed. Return the items which are still frozen to the oven and press **START/Enter** to complete the defrost cycle.

## NOTE

- The countdown appears in the display after **START/Enter** is pressed. The oven chimes once during the defrost cycle.
- When using this defrost function, the weight to be entered is the net weight in pounds and tenths of pounds (the weight of the food minus the container).

## Defrost Menu

Refer to the information below to set the desired code and weight.

### dEF1 Meat (0.1 - 6.0 lbs)

- Beef: Ground beef, round steak, stew cubes, tenderloin steak, pot roast, rib roast, rump roast, chuck roast, hamburger patties
- Lamb: Chops, rolled roast
- Pork: Chops, hot dogs, spareribs, country-style ribs, rolled roast, sausage
- Veal: Cutlets (1 lb., ½ inch thick)
- Turn food over at beep.
- Standing time: 5-15 minutes

### dEF2 Poultry (0.1 - 6.0 lbs)

- Poultry: Whole, cut-up, breast (boneless)
- Cornish Hens: Whole
- Turkey: Breast
- Rinse chicken with tap water before cooking and let stand for 60 minutes after cooking for better results.
- Turn food over at beep.
- Standing time: 60 minutes

### dEF3 Fish (0.1 - 4.0 lbs)

- Fish: Fillets, whole steaks
- Shellfish: Crab meat, lobster tails, shrimp, scallops
- Turn food over at beep.
- Standing time: 5-10 minutes

### dEF4 Bread (0.1 - 2.0 lbs)

- Sliced bread, buns, baguettes, etc.
- Separate slices and place between paper towels or on flat plate. Turn food over at beep.
- Standing time: 1-2 minutes

## Cookware Guide

### Microwave-Safe Cookware

Use microwavable cookware.

#### • Ovenproof Glass

- Ovenproof glassware that is treated for high intensity heat so it is heat-resistant is microwave-safe.
- Use utility dishes, loaf dishes, pie plates, cake plates, liquid measuring cups, casseroles and bowls without metal rims.
- Do not use delicate glassware, such as tumblers or wine glasses, as these might shatter when heated.

#### • China

- Use bowls, cups, serving plates, pottery, stoneware, ceramic, and platters without metal rims or handles. Many containers made of these materials are microwave-safe, but test them before use.

#### • Plastic

- **Plastic Storage Containers:** Use plastic dishes, cups, semi-rigid freezer containers and plastic bags only for short cooking times. Do not use them when cooking food for long periods or at high power levels, as the hot food will eventually warp or melt the plastic.
- **Plastic wrap (as a cover):** Lay the plastic wrap loosely over the dish and press it to the sides. Vent plastic wrap by turning back one edge slightly to allow excess steam to escape. The dish should be deep enough so that the plastic wrap will not touch the food. As the food heats it may melt the plastic wrap wherever the wrap touches the food.
- **Plastic Cooking Bags:** Provided they are specially made for cooking, cooking bags are microwave safe. Remember to make a slit in the bag so that steam can escape. Never use ordinary plastic bags for cooking in the microwave oven, as they will melt and rupture.
- **Plastic Microwave Cookware:** A variety of shapes and sizes of microwave cookware are available. You may be able to use items you already have on hand rather than investing in new kitchen equipment.

### • Paper

- Use paper towels, waxed paper, paper napkins, and paper plates with no metal rims or design. Look for the manufacturer's label for use in the microwave oven.
- Paper plates and containers are convenient and safe to use in the microwave oven, provided that the cooking time is short and the foods to be cooked are low in fat and moisture. Paper towels are also very useful for wrapping foods and for lining baking trays in which greasy foods such as bacon are cooked.
- Avoid colored paper products as the color may run. Do not use recycled paper products in the microwave oven. They may contain impurities which could cause arcing or fires when used in the microwave.

### • Tableware

- Many containers made of pottery, stoneware and ceramic are also microwave-safe. If in doubt consult the manufacturer's literature or perform the microwave test.
- Do not put plates with painted decoration in the oven, as the paint may contain metal and cause arcing.

## Microwave-Unsafe Cookware

### • Metal Containers/Metal Decoration

- Never use metal or metal-rimmed cookware in the microwave oven.
- Microwaves cannot penetrate metal. They will bounce off any metal object in the oven and cause arcing, an alarming phenomenon that resembles lightning.
- Metal shields the food from microwave energy and produces uneven cooking. Also avoid metal skewers, thermometers, foil trays, metal-rimmed or metal-banded dinnerware, casserole dishes, etc. The metal rim interferes with normal cooking and may damage the oven.

### • Aluminum Foil

- Avoid large sheets of aluminum foil because they hinder cooking and may cause harmful arcing.
- Use small pieces of foil to shield poultry legs and wings.
- Keep ALL aluminum foil at least 1 inch from the side walls and door of the oven.

### • Wood

- Wood bowls and boards will dry out and may split or crack when you use them in the microwave oven.
- Baskets react in the same way.

### • Tightly Covered Cookware

- Be sure to leave openings for steam to escape from covered containers.
- Pierce plastic pouches of vegetables or other food items before cooking.
- Tightly closed pouches could explode.

### • Brown Paper

- Avoid using brown paper bags.
- They absorb too much heat and could burn.

### • Flawed or Chipped Cookware

- Any container that is cracked, flawed, or chipped may break in the oven.

### • Metal Twist Ties

- Remove metal twist ties from plastic or paper bags.
- They become hot and could cause a fire.

## Testing Cookware before Use

Most heat resistant and non-metallic cookware is safe for use in your oven. However, some cookware may contain materials that are not suitable for microwave use. Follow the steps below to find out if cookware can be used in the microwave.

- 1 Place the container in question and a glass measuring cup filled with water next to each other inside the oven.
- 2 Heat the container and glass measuring cup for 1 minute at HIGH power.
  - If the water heats up but the container remains cool to the touch, the container is microwave-safe.
  - If the temperature of the water does not change but the container becomes warm, it is not safe for use in the microwave oven.

---

### CAUTION

- Some items with high lead or iron content are not suitable for microwave cooking.
- Cookware should be checked to ensure that it is suitable for use in the microwave.



- Always be careful when taking cookware out of the oven. Some dishes absorb heat from the cooked food and may be hot.

## Cooking Guide

### Cooking Tips

Carefully monitor the food in the microwave oven while it is cooking. Directions given in recipes to elevate, stir, etc., are the minimum steps recommended. If food is overcooked (dry), undercooked, or unevenly cooked, make adjustments before or during cooking to correct the problem.

- **Overcooked or Dry Food**
  - **Sprinkling:** Sprinkle low-moisture foods such as roasts and vegetables with water before cooking, or cover them to retain moisture.
  - **Density:** Light, porous food such as cakes and breads cook more quickly than heavy, dense foods such as roasts and casseroles.
  - **Shielding:** Cover the corners of square dishes with small strips of aluminum foil to prevent overcooking. Don't use too much foil, and secure the foil to the dish. Foil can cause arcing if it gets too close to the oven walls during cooking.
  - **Bones and Fat:** Bones conduct heat, and fat cooks more quickly than meat. Take care with bony or fatty cuts of meat.
- **Undercooked Food**
  - **Covering:** Cover food with a microwave-safe lid, parchment paper (not waxed paper), or plastic wrap to trap heat and steam and cook food more quickly.
  - **Standing Time:** Let food stand for several minutes after being removed from the oven to allow it to finish cooking and help flavors blend and develop.
  - **Quantity:** The more food you place in the oven, the longer the required cooking time.
  - **Temperature:** Ice-cold ingredients take much longer to cook than room temperature ingredients.
- **Unevenly Cooked Food**
  - **Stirring:** Stir food from the outside toward the center during cooking, as food at the outside of the dish heats more quickly.
  - **Arranging:** Turn food over several times during cooking. The upper portion of thick foods cooks more quickly than the lower portion.
- **Shaping:** Place the thickest portions of foods like meat, poultry or fish toward the outside of the cookware to help them cook more evenly. If possible, shape foods into thin rounds or rings.
- **Foods with Skin, Shell or Membrane**
  - **Skin or Membrane:** Pierce the outsides of foods like potatoes, sausages, or egg whites or yolks before cooking.
  - **Shell:** Pierce or remove the shells from eggs, clams, oysters, or other shelled foods before cooking.
- **Defrosting Tips**
  - Remove fish, shellfish, meat, and poultry from its original wrapping paper or plastic package. Otherwise, the wrap close to the foods will hold steam and heat, which can cause the outer surface of the foods to be cooked.
  - Remove any metal twist ties.
  - Always slit or pierce plastic pouches or packaging.
  - Open containers such as cartons before they are placed in the oven.
  - If food is foil wrapped, remove the foil and place the food in a suitable container.
  - The length of defrosting time varies depending on the shape of the food and on how solidly the food is frozen.
  - As food begins to defrost, separate the food into pieces so that they can defrost more easily.
  - Turn over food during defrosting or standing time. Separate into pieces and remove food as required.
  - Let food stand after defrosting. Food should still be somewhat icy in the center when removed from the oven.
  - When using Defrost, the weight to be entered is the net weight in pounds and tenths of pounds (the weight of the food minus the container).
  - Slit the skins of frozen foods such as sausage.
  - Bend plastic pouches of food to ensure even defrosting.
  - Place food in a shallow container or in a microwave roasting dish to catch the drippings.
  - Always underestimate defrosting time. Food should still be somewhat icy in the center when removed from the oven. If defrosted

## 18 OPERATION

---

food is still frozen solid in the center, return it to the microwave oven for more defrosting.

- Depending on the shape of the food, some areas may defrost more quickly than others.
- The shape of the package affects how quickly food will defrost. Shallow packages will defrost more quickly than a deep block.
- For best results, shape ground meat into the form of a doughnut before freezing. When defrosting, scrape off thawed meat when the beep sounds and continue defrosting.
- Use small pieces of aluminum foil to shield parts of food such as chicken wings, leg tips, fish tails, or areas that start to get warm. Make sure the foil does not touch the sides, top, or bottom of the oven. The foil can damage the oven lining.

### Precautions



---

#### WARNING

- Do not use your microwave oven to cook eggs in the shell. Pressure can build up inside the shell, causing it to burst.
  - Never operate the oven when it is empty. Food or water should always be in the oven during operation to absorb the microwave energy.
- 
- Place the front surface of the door three inches or more from the edge of a countertop to avoid accidental tipping of the microwave oven during normal use.
  - To program the oven, press the center of each button firmly. When a button is pressed correctly, a beep sounds and the oven is activated. Do not press several buttons at once.
  - Do not strike the control panel with silverware, utensils, etc. It may be damaged or broken.
  - Always be careful when taking cookware out of the oven. Some dishes absorb heat from the cooked food and may be hot. See the Cookware Guide section for more information.
  - To avoid breakage, allow cookware to cool before rinsing or submerging in water. Always allow the turntable to cool before removing it from the oven.
  - Do not use the oven to dry newspapers or clothes. They may catch fire.
  - Use thermometers that have been approved for microwave oven cooking.
  - The turntable must always be in place when you operate the oven.

# SMART FUNCTIONS

## LG ThinQ Application

This feature is only available on models with the  or  logo.

The **LG ThinQ** application allows you to communicate with the appliance using a smartphone.

### LG ThinQ Application Features

Communicate with the appliance from a smartphone using the convenient smart features.

### Smart Diagnosis™

This function provides useful information for diagnosing and solving issues with the appliance based on the pattern of use.



#### NOTE

- This information is current at the time of publication. The application is subject to change for product improvement purposes without notice to users.

### Installing the LG ThinQ Application

Search for the **LG ThinQ** application from the Google Play Store or Apple App Store on a smartphone. Follow instructions to download and install the application.

## Smart Diagnosis™ Feature

This feature is only available on models with the  or  logo.

Use this feature to help you diagnose and solve problems with your appliance.

#### NOTE

- For reasons not attributable to LGE's negligence, the service may not operate due to external factors such as, but not limited to, Wi-Fi unavailability, Wi-Fi disconnection, local app store policy, or app unavailability.
- The feature may be subject to change without prior notice and may have a different form depending on where you are located.

## Using Audible Diagnosis to Diagnose Issues

Follow the instructions below to use the audible diagnosis method.

- Launch the **LG ThinQ** application and select the **Smart Diagnosis™** feature in the menu. Follow the instructions for audible diagnosis provided in the **LG ThinQ** application.

- 1 Hold the mouthpiece of your phone over the **Smart Diagnosis™** icon. Do not touch any other buttons.

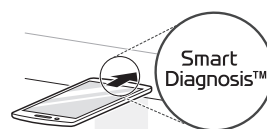

- 2 Press and hold the **STOP/Clear** button for 8 seconds until **5** appears in the display.
- 3 After you hear three beeps, release the **STOP/Clear** button.
- 4 Keep the phone in place until the tone transmission has finished. The display will count down the time. Once the countdown is over and the tones have stopped, the diagnosis will be displayed in the application.

#### NOTE

- For best results, do not move the phone while the tones are being transmitted.

# MAINTENANCE

## Cleaning

### Cleaning the Interior

- 1 Use a damp cloth to clean the surfaces of the door and wipe out crumbs between the door and the frame.
- 2 Remove greasy spatters with a soapy cloth and then rinse and dry.
  - Wipe spatters immediately with a wet paper towel, especially after cooking chicken or bacon.
  - If steam accumulates inside or outside of the oven door, wipe the panels with a soft cloth.
  - For stubborn soil, boil a cup of water in the oven for 2 to 3 minutes. Steam will soften the soil. To get rid of odors inside the oven, boil a cup of water with some lemon juice or vinegar in it.
  - If some induction cleaners containing abrasives are used, the appearance of the product may be damaged.

### Cleaning the Exterior

- 1 Clean the outside of the oven with soap and water.
- 2 Rinse with clean water and dry with a soft cloth or paper towel.
  - To prevent damage to the internal working parts of the oven, do not allow water to seep into the ventilation openings.
  - The door and door seals should be kept clean. Use warm, soapy water to clean. Rinse off soap residue and dry thoroughly.
  - Frequently wipe metal parts with a damp cloth.

### Cleaning the Control Panel

- 1 Open the door to prevent the oven from accidentally starting.

- 2 Wipe with a damp cloth followed immediately by a dry cloth.

- 3 Press **STOP** after cleaning.

### Cleaning the Accessories

Wash the glass tray and rotating ring in mild, sudsy water. For heavily soiled areas, use a mild cleanser and scouring sponge. Dry completely before use.

- The glass tray and rotating ring are dishwasher safe.

---

#### NOTE

- Abrasive cleansers, steel wool pads, gritty wash cloths, some paper towels, and other abrasive surfaces can damage the control panel and the interior and exterior oven surfaces.
-

# TROUBLESHOOTING

## FAQs

### Frequently Asked Questions

<b>Q</b>	<b>What's wrong when the oven light will not glow?</b>
<b>A</b>	There may be several reasons why the oven light will not glow. Either the light bulb has blown or the electric circuit has failed.
<b>Q</b>	<b>Does microwave energy pass through the viewing screen in the door?</b>
<b>A</b>	No. The holes, or ports, are made to allow light to pass; they do not let microwave energy through.
<b>Q</b>	<b>Why does the beep tone sound when a button on the control panel is touched?</b>
<b>A</b>	The beep tone sounds to assure that the setting is being properly entered.
<b>Q</b>	<b>Will the microwave function be damaged if it operates empty?</b>
<b>A</b>	Yes. Never run it empty.
<b>Q</b>	<b>Why do eggs sometimes pop?</b>
<b>A</b>	When baking, frying, or poaching eggs, the yolk may pop due to steam build up inside the yolk membrane. To prevent this, simply pierce the yolk before cooking. Never microwave eggs in the shell.
<b>Q</b>	<b>Why is standing time recommended after microwave cooking is over?</b>
<b>A</b>	After microwave cooking is finished, food keeps on cooking during standing time. This standing time finishes cooking evenly throughout the food. the amount of standing time depends on the density of the food.
<b>Q</b>	<b>Why doesn't my oven always cook as fast as the cooking guide says?</b>
<b>A</b>	<ul style="list-style-type: none"> <li>• Check your cooking guide again to make sure you have followed directions correctly, and to see what might cause variations in cooking time.</li> <li>• Cooking guide times and heat settings are suggestions, chosen to help prevent overcooking, the most common problem in getting used to this oven.</li> <li>• Variations in the size, shape, weight and dimensions of the food require longer cooking time.</li> <li>• Use your own judgment along with the cooking guide suggestions to test food conditions, just as you would do with a conventional cooker.</li> </ul>
<b>Q</b>	<b>Why does the word 'cool' or remaining cooking time appear in the display with fan noise after microwave cooking is over?</b>
<b>A</b>	After cooking is complete, the fan may operate to cool the oven. The display will show Cool. If you open the door or press once <b>STOP</b> before the cooking time is complete, the remaining cooking time will show on the display. This is not a malfunction.

## Before Calling for Service

### Operation

Problem	Possible Cause & Solution
<b>Microwave oven does not start</b>	<p><b>Power cord is unplugged, door is open, or cooking time has not been set.</b></p> <ul style="list-style-type: none"> <li>• Plug in power cord.</li> <li>• Close oven door.</li> <li>• Set cooking time.</li> </ul>
<b>Arcing or Sparking</b>	<p><b>Cookware is not microwave safe, or the oven is being operated while it is empty.</b></p> <ul style="list-style-type: none"> <li>• Use microwave-safe utensils. When in doubt, test utensils before use.</li> <li>• Do not operate oven while it is empty.</li> </ul>
<b>Incorrect Time of Day</b>	<p><b>Power is interruption.</b></p> <ul style="list-style-type: none"> <li>• Reset the time. See Setting the Clock section to reset time of day.</li> </ul>
<b>Unevenly Cooked Foods</b>	<p><b>Cookware is not microwave safe, or cook settings were wrong.</b></p> <ul style="list-style-type: none"> <li>• Test cookware to make sure it is microwave safe.</li> <li>• Do not cook without the glass tray.</li> <li>• Turn or stir food while cooking.</li> <li>• Defrost food completely before cooking.</li> <li>• Use correct cook time and power level.</li> </ul>
<b>Overcooked Foods</b>	<p><b>Cooking settings and methods are wrong.</b></p> <ul style="list-style-type: none"> <li>• Change cook time or power level.</li> </ul>
<b>Undercooked Foods</b>	<p><b>Cookware is not microwave safe, or cook settings were wrong.</b></p> <ul style="list-style-type: none"> <li>• Test that cookware is microwave safe.</li> <li>• Defrost food completely before cooking.</li> <li>• Change cook time or power level.</li> <li>• Make sure that ventilation ports are not blocked.</li> </ul>
<b>Improper Defrosting</b>	<p><b>Cookware is not microwave safe, or cook settings were wrong.</b></p> <ul style="list-style-type: none"> <li>• Test that cookware is microwave safe.</li> <li>• Change defrost time or weight.</li> <li>• Turn or stir food during defrost cycle.</li> </ul>

# LIMITED WARRANTY

## USA

### TERMS AND CONDITIONS

**ARBITRATION NOTICE: THIS LIMITED WARRANTY CONTAINS AN ARBITRATION PROVISION THAT REQUIRES YOU AND LG ELECTRONICS ("LG") TO RESOLVE DISPUTES BY BINDING ARBITRATION INSTEAD OF IN COURT, UNLESS YOU CHOOSE TO OPT OUT. IN ARBITRATION, CLASS ACTIONS AND JURY TRIALS ARE NOT PERMITTED. PLEASE SEE THE SECTION TITLED "PROCEDURE FOR RESOLVING DISPUTES" BELOW.**

Should your LG Microwave Oven ("Product") fail due to a defect in materials or workmanship under normal and proper use, during the warranty period set forth below, LG will, at its option, repair or replace the Product. This limited warranty is valid only to the original retail purchaser of the Product ("You") and applies only when purchased lawfully and used within the United States including U.S. Territories.

WARRANTY PERIOD	
Microwave Oven	Magnetron
One (1) year from the date of original retail purchase	Ten (10) years from the date of original retail purchase
Parts and Labor (internal/functional parts only excluding magnetron)	Parts only (You are responsible for any applicable labor cost)

- Replacement Products and parts are warranted for the remaining portion of the original warranty period or ninety (90) days, whichever is greater.
- Replacement Products and parts may be new, reconditioned, refurbished, or otherwise factory remanufactured.
- Replaced Product or part(s) will be the property of LG.
- Proof of original retail purchase specifying the Product model and date of purchase is required to obtain warranty service under this limited warranty.

EXCEPT TO THE EXTENT PROHIBITED BY APPLICABLE LAW, ANY IMPLIED WARRANTY OF MERCHANTABILITY OR FITNESS FOR A PARTICULAR PURPOSE ON THE PRODUCT IS LIMITED IN DURATION TO THE DURATION OF THE ABOVE LIMITED WARRANTY. UNDER NO CIRCUMSTANCES SHALL LG OR ITS U.S. DISTRIBUTORS/DEALERS BE LIABLE FOR ANY INDIRECT, INCIDENTAL, CONSEQUENTIAL, SPECIAL, OR PUNITIVE DAMAGES, INCLUDING, WITHOUT LIMITATION, LOST GOODWILL, LOST REVENUES OR PROFITS, WORK STOPPAGE, IMPAIRMENT OF OTHER GOODS, COST OF REMOVAL AND REINSTALLATION OF THE PRODUCT, LOSS OF USE, OR ANY OTHER DAMAGES WHETHER BASED IN CONTRACT, TORT, OR OTHERWISE. LG'S TOTAL LIABILITY, IF ANY, SHALL NOT EXCEED THE PURCHASE PRICE PAID BY YOU FOR THE PRODUCT.

**SOME STATES DO NOT ALLOW THE EXCLUSION OR LIMITATION OF INCIDENTAL OR CONSEQUENTIAL DAMAGES OR LIMITATIONS ON HOW LONG AN IMPLIED WARRANTY LASTS, SO THE ABOVE EXCLUSIONS OR LIMITATIONS MAY NOT APPLY TO YOU. THIS LIMITED WARRANTY GIVES YOU SPECIFIC LEGAL RIGHTS AND YOU MAY ALSO HAVE OTHER RIGHTS THAT VARY FROM STATE TO STATE.**

### THIS LIMITED WARRANTY DOES NOT COVER:

- Service trips to deliver, pick up, or install, educate how to operate, correct wiring, or correct unauthorized repairs.
- Damage or failure of the Product to perform during power failures and interrupted or inadequate electrical service.

## 24 LIMITED WARRANTY

---

- Damage or failure of the Product caused by leaky or broken water pipes, frozen water pipes, restricted drain lines, inadequate or interrupted water supply or inadequate supply of air.
- Damage or failure of the Product resulting from operating the Product in a corrosive atmosphere or contrary to the Product owner's manual.
- Damage or failure of the Product caused by accidents, pests and vermin, lightning, wind, fire, floods, acts of nature, or any other causes beyond the control of LG.
- Damage or failure of the Product caused by unauthorized modification or alteration, or if the Product is used for other than the intended purpose, or any water leakage where the Product was not properly installed.
- Damage or failure of the Product caused by incorrect electrical current, voltage, or plumbing codes.
- Damage or failure of the Product caused by transportation, storage, and/or handling, including scratches, dents, chips, and/or other damage to the finish of the Product, unless such damage is reported within one (1) week of delivery.
- Damage or failure of the Product resulting from misuse, abuse, improper installation, repair, or maintenance. Improper repair includes the use of parts not authorized by LG. Improper installation or maintenance includes installation or maintenance contrary to the Product owner's manual.
- Damage or failure of the Product caused by the use of parts, components, accessories, consumable cleaning products, or any other products or services that were not authorized by LG.
- Damage or missing items to any display or open box Product.
- Refurbished Product or any Product sold "As Is", "Where Is", "With all Faults", or similar disclaimer.
- Products with original serial numbers that have been removed, altered, or cannot be readily determined.
- Increases in utility costs and additional utility expenses.
- Any noises associated with normal operation.
- Products used for other than normal and proper household use (e.g., commercial or industrial use) or contrary to the Product owner's manual.
- Costs associated with removal and reinstallation of the Product for repairs, or the removal and reinstallation of the Product if it is installed in an inaccessible location or not installed in accordance with the Product Owner's manual.
- Accessories, removable components, or consumable parts (e.g. Shelves, door bins, drawers, water/air filters, racks, light bulbs, batteries, etc., as applicable), except for internal/functional parts covered under this limited warranty.

**The cost of repair or replacement under these excluded circumstances shall be borne by You.**

TO OBTAIN WARRANTY SERVICE AND ADDITIONAL INFORMATION

Call [1-800-243-0000](tel:1-800-243-0000) and select the appropriate option from the menu.

Or visit our website at <http://www.lg.com>

Or by mail: LG Electronics Customer Service P.O. Box 240007 Huntsville, AL 35813 ATTN: CIC

### PROCEDURE FOR RESOLVING DISPUTES:

**ALL DISPUTES BETWEEN YOU AND LG ARISING OUT OF OR RELATING IN ANY WAY TO THIS LIMITED WARRANTY OR THE PRODUCT SHALL BE RESOLVED EXCLUSIVELY THROUGH BINDING ARBITRATION, AND NOT IN A COURT OF GENERAL JURISDICTION. BINDING ARBITRATION MEANS THAT YOU AND LG ARE EACH WAIVING THE RIGHT TO A JURY TRIAL AND TO BRING OR PARTICIPATE IN A CLASS ACTION.**

**Definitions.** For the purposes of this section, references to "LG" mean LG Electronics U.S.A., Inc., its parents, subsidiaries and affiliates, and each of their officers, directors, employees, agents, beneficiaries, predecessors in interest, successors, assigns and suppliers; references to "dispute" or "claim" shall include any dispute, claim or controversy of any kind whatsoever (whether based in contract, tort, statute, regulation, ordinance, fraud, misrepresentation or any other legal or equitable theory) arising out of or relating in any way to the sale, condition or performance of the product or this Limited Warranty.

**Notice of Dispute.** In the event you intend to commence an arbitration proceeding, you must first notify LG in writing at least 30 days in advance of initiating the arbitration by sending a letter to LG at LG



Electronics, USA, Inc. Attn: Legal Department- Arbitration 111 Sylvan Ave, Englewood Cliffs, NJ 07632. You and LG agree to engage in good faith discussions in an attempt to amicably resolve your claim. The notice must provide your name, address, and telephone number; identify the product that is the subject of the claim; and describe the nature of the claim and the relief being sought. If you and LG are unable to resolve the dispute within 30 days, either party may proceed to file a claim for arbitration.

**Agreement to Binding Arbitration and Class Action Waiver.** Upon failure to resolve the dispute during the 30 day period after sending written notice to LG, you and LG agree to resolve any claims between us only by binding arbitration on an individual basis, unless you opt out as provided below. Any dispute between you and LG shall not be combined or consolidated with a dispute involving any other person's or entity's product or claim. More specifically, without limitation of the foregoing, any dispute between you and LG shall not under any circumstances proceed as part of a class or representative action. Instead of arbitration, either party may bring an individual action in small claims court, but that small claims court action may not be brought on a class or representative basis.

**Arbitration Rules and Procedures.** To begin arbitration of a claim, either you or LG must make a written demand for arbitration. The arbitration will be administered by the American Arbitration Association ("AAA") and will be conducted before a single arbitrator under the AAA's Consumer Arbitration Rules that are in effect at the time the arbitration is initiated (referred to as the "AAA Rules") and under the procedures set forth in this section. The AAA Rules are available online at [www.adr.org/consumer](http://www.adr.org/consumer). Send a copy of your written demand for arbitration, as well as a copy of this provision, to the AAA in the manner described in the AAA Rules. You must also send a copy of your written demand to LG at LG Electronics, USA, Inc. Attn: Legal Department- Arbitration 111 Sylvan Avenue, Englewood Cliffs, NJ 07632. If there is a conflict between the AAA Rules and the rules set forth in this section, the rules set forth in this section will govern. This arbitration provision is governed by the Federal Arbitration Act. Judgment may be entered on the arbitrator's award in any court of competent jurisdiction. All issues are for the arbitrator to decide, except that issues relating to the scope and enforceability of the arbitration provision and to the arbitrability of the dispute are for the court to decide. The arbitrator is bound by the terms of this provision.

**Governing Law.** The law of the state of your residence shall govern this Limited Warranty and any disputes between us except to the extent that such law is preempted by or inconsistent with applicable federal law.

**Fees/Costs.** You do not need to pay any fee to begin an arbitration. Upon receipt of your written demand for arbitration, LG will promptly pay all arbitration filing fees to the AAA unless you seek more than \$25,000 in damages, in which case the payment of these fees will be governed by the AAA Rules. Except as otherwise provided for herein, LG will pay all AAA filing, administration and arbitrator fees for any arbitration initiated in accordance with the AAA Rules and this arbitration provision. If you prevail in the arbitration, LG will pay your attorneys' fees and expenses as long as they are reasonable, by considering factors including, but not limited to, the purchase amount and claim amount. Notwithstanding the foregoing, if applicable law allows for an award of reasonable attorneys' fees and expenses, an arbitrator can award them to the same extent that a court would. If the arbitrator finds either the substance of your claim or the relief sought in the demand is frivolous or brought for an improper purpose (as measured by the standards set forth in Federal Rule of Civil Procedure 11(b)), then the payment of all arbitration fees will be governed by the AAA Rules. In such a situation, you agree to reimburse LG for all monies previously disbursed by it that are otherwise your obligation to pay under the AAA Rules. Except as otherwise provided for, LG waives any rights it may have to seek attorneys' fees and expenses from you if LG prevails in the arbitration.

**Hearings and Location.** If your claim is for \$25,000 or less, you may choose to have the arbitration conducted solely on the basis of (1) documents submitted to the arbitrator, (2) through a telephonic hearing, or (3) by an in-person hearing as established by the AAA Rules. If your claim exceeds \$25,000, the right to a hearing will be determined by the AAA Rules. Any in-person arbitration hearings will be held at a location within the federal judicial district in which you reside unless we both agree to another location or we agree to a telephonic arbitration.

**Opt Out.** You may opt out of this dispute resolution procedure. If you opt out, neither you nor LG can require the other to participate in an arbitration proceeding. To opt out, you must send notice to LG no later than 30 calendar days from the date of the first consumer purchaser's purchase of the product by either: (i) sending an e-mail to [optout@lge.com](mailto:optout@lge.com), with the subject line: "Arbitration Opt Out" or (ii) calling [1-800-980-2973](tel:1-800-980-2973). You must include in the opt out e-mail or provide by telephone: (a) your name and address; (b) the date on which the product was purchased; (c) the product model name or model number; and (d)

## 26 LIMITED WARRANTY

---

the serial number (the serial number can be found (i) on the product; or (ii) online by accessing <https://www.lg.com/us/support/repair-service/schedule-repair-continued> and clicking on "Find My Model & Serial Number").

You may only opt out of the dispute resolution procedure in the manner described above (that is, by e-mail or telephone); no other form of notice will be effective to opt out of this dispute resolution procedure.

Opting out of this dispute resolution procedure will not affect the coverage of the Limited Warranty in any way, and you will continue to enjoy the full benefits of the Limited Warranty. If you keep this product and do not opt out, then you accept all terms and conditions of the arbitration provision described above.





**LG Customer Information Center**

For inquiries or comments, visit **www.lg.com** or call:

**1-800-243-0000** U.S.A.

**1-888-542-2623** CANADA

Register your product Online!

**www.lg.com**

**Centro de Información al Cliente LG**

Para consultas o comentarios, visite **www.lg.com** o llame por teléfono:

**1-800-243-0000** EE.UU.

**1-888-542-2623** CANADÁ

¡Registre su producto en línea!

**www.lg.com**

**Centre de Service à la Clientèle de LG**

Pour des questions ou des commentaires, visitez **www.lg.com/ca\_fr** ou appelez :

**1-800-243-0000** ÉTATS-UNIS

**1-888-542-2623** CANADA

Enregistrez votre produit en ligne!

**www.lg.com/ca\_fr**