

dacor[®]

User Manual

Modernist Built-In Microwave Combi Oven

DOC30M977D



To Our Valued Customer:

Congratulations on your purchase of the very latest in Dacor® products! Our unique combination of features, style, and performance make us a great addition to your home. To familiarize yourself with the controls, functions and full potential of your new Dacor combi oven, read this manual thoroughly, starting at the **Before you begin** section.

Dacor appliances are designed and manufactured with quality and pride, while working within the framework of our company values. Should you ever have an issue with your combi oven, first check the **Troubleshooting** section for guidance. It gives suggestions and remedies that may pre-empt a call for service.

Valuable customer input helps us continually improve our products and services, so feel free to contact our Customer Assurance Team for assistance with all your product-support needs.

Dacor Customer Assurance Team

14425 Clark Avenue
City of Industry, CA 91745

Telephone: (800) 793-0093

Fax: (626) 403-3130

Hours of Operation: Mon – Fri, 5:00 A.M. to 5:00 P.M. Pacific Time

Website: www.dacor.com/customer-care/contact-us

Thanks for choosing Dacor for your home. We are a company built by families for families, and we are dedicated to serving yours. We are confident that your new Dacor combi oven will deliver a top-level performance and enjoyment for decades to come.

Sincerely,

The Dacor Customer Assurance Team

Regulatory Notice

Precautions to avoid exposure to excessive microwave energy

- A. Do not place anything between the chassis face and door, or let soil/cleaner residue collect on the seal.
- B. Do not operate the microwave if it is damaged. It is critical that the door close properly and that there is no damage to the:
 - 1. Door (bent),
 - 2. Hinges and latches (broken or loose),
 - 3. Door seals and sealing surface.
- C. The microwave should only be adjusted/repaired by qualified service personnel.

1. FCC Notice

CAUTION

FCC CAUTION: Modifications not expressly approved by the party responsible for compliance could void the user's authority to operate the equipment. This device complies with Part 15 of FCC Rules. Operation is subject to following these conditions:

- 1. This device may not cause harmful interference, and
- 2. This device must accept any interference received including interference that causes undesired operation.

For products sold in the US and Canadian markets, only channels 1–11 are available. You cannot select any other channels.

Regulatory Notice

FCC STATEMENT:

This equipment was tested and found compliant within the limits for a Class B digital device, pursuant to Part 15 of FCC Rules. These limits are designed to provide reasonable protection against harmful interference in a residential installation. This equipment generates, uses, and can radiate radio frequency energy, and, if not installed and used as instructed, may interfere with radio communications. However, there is no guarantee that interference will not occur in a given installation. If this equipment does interfere with radio or television reception, which can be determined by turning the equipment off and on, the user should try to correct the interference via one or more of these measures:

- Reorienting or relocating the receiving antenna
- Increasing the distance between the equipment and receiver
- Connecting the equipment to an outlet that is on a different circuit than the radio/TV
- Consulting the dealer or an experienced radio/TV technician.

FCC RADIATION EXPOSURE STATEMENT:

This equipment complies with FCC radiation exposure limits set forth for an uncontrolled environment. This equipment should be installed and operated with at least 8 in. (20 cm) between the radiator and your body. This device and its antenna(s) must not be co-located or operated together with any other antenna or transmitter.

2. IC Notice

The term "IC" before the radio certification number means Industry Canada technical specifications were met. Operation is subject to these conditions: 1) This device may not cause interference, and 2) This device must accept any interference, including that which may cause undesired operation of the device. This Class B digital apparatus complies with Canadian ICES-003.

For products sold in the US and Canada, only channels 1–11 can be selected.

IC RADIATION EXPOSURE STATEMENT:

This equipment complies with IC RSS-102 radiation exposure limits set forth for an uncontrolled environment. This equipment should be installed and operated with at least 8 in. (20 cm) between the radiator and your body. This device and its antenna(s) must not be co-located or operated together with any other antenna or transmitter.

Contents

| | |
|-------------------------------------|-----------|
| Important safety information | 7 |
| <hr/> | |
| Introducing your new oven | 15 |
| Overview | 15 |
| What's included with your oven | 16 |
| <hr/> | |
| Before you begin | 17 |
| Energy saving tips | 17 |
| Optitray (For microwave oven) | 17 |
| Water reservoir | 18 |
| <hr/> | |
| Basic operations | 19 |
| Control panel | 19 |
| Microwave | 19 |
| Display (Oven) | 20 |
| Control lockout | 21 |
| Kitchen timer | 22 |
| <hr/> | |
| Microwave oven (Upper Oven) | 25 |
| Setting the power level | 25 |
| Timed cooking | 25 |
| Microwave | 27 |
| Convection Sear | 28 |
| Broil | 29 |
| Speed Conv.Sear Speed | 30 |
| Broil | 31 |
| Sense Cook™ | 32 |
| Conv.Sear AutoCook | 35 |
| Healthy Fry | 38 |
| Defrost | 39 |
| Healthy Choice | 40 |
| Auto Cook | 43 |
| Soften / Melt | 51 |

| | |
|------------------------------------------------|-----------|
| Oven (Lower Oven) | 53 |
| Timed cooking | 53 |
| Delay start | 54 |
| Using the temp probe | 56 |
| Oven functions | 58 |
| Using the special function feature | 63 |
| Using the iQ control feature (Lower oven only) | 67 |
| Using the oven racks | 68 |
| Using the gliding rack | 69 |
| Using the clean feature | 71 |
| Settings | 79 |
| Using the Sabbath feature | 82 |
| | |
| Maintaining your appliance | 84 |
| Care and cleaning of the oven | 84 |
| Removing the oven door (Lower oven only) | 87 |
| Replacing the oven door (Lower oven only) | 88 |
| Changing the oven light (Lower oven only) | 89 |
| | |
| Troubleshooting | 90 |
| Control display | 90 |
| For the microwave oven | 90 |
| For the lower oven | 93 |
| Information codes | 95 |
| | |
| Warranty and Service | 96 |
| Getting Help | 96 |
| Warranty | 96 |
| | |
| Appendix | 98 |
| Open-source announcement | 98 |

Important safety information

To avoid fire, electric shock, and personal injury, read this guide thoroughly before using the oven.

Contact your service agent or the manufacturer about issues you cannot resolve.

What you need to know about safety instructions

The warnings and important safety instructions in this manual do not cover all conditions that may occur. Use common sense and caution in maintaining and operating your oven.

What the icons and signs in this user manual mean:

WARNING









Hazards or unsafe practices that may result in severe personal injury or death.

CAUTION

Hazards or unsafe practices that may result in minor personal injury or property damage.

CAUTION

To reduce the risk of fire, explosion, electric shock, or personal injury when using your oven, follow these basic safety precautions.

| | |
|-------------------------------------------------------------------------------------|--------------------------------------------------------------|
|  | Do NOT attempt. |
|  | Do NOT disassemble. |
|  | Do NOT touch. |
|  | Follow directions explicitly. |
|  | Unplug the power plug from the wall socket. |
|  | Make sure the machine is grounded to prevent electric shock. |
|  | Call a Dacor service center for help. |
|  | Note |

These warning signs are intended to prevent personal injury. Follow them explicitly. After reading this guide, keep it in a convenient place for reference.

State of California Proposition 65 warning (US only)

WARNING :This product contains chemicals known to the State of California to cause cancer and birth defects or other reproductive harm.

WARNING

To reduce risk of electric shock, fire, injury, or exposure to excessive microwave energy:

- Read all safety instructions before using the appliance.
- Read and follow **Precautions to avoid exposure to excessive microwave energy**, pg. 3.
- Install the combi oven according to the provided Installation Instructions.
- Do not heat whole eggs and sealed containers in the microwave.
- The combi oven is not for industrial or laboratory use.
- Do not put corrosive chemicals in the combi oven.
- Closely supervise children around the oven. Keep children away from the door when opening or closing.
- Do not operate the combi if it is damaged or malfunctioning.
- The combi should be repaired/serviced only by qualified service personnel. Contact an authorized service facility for examination/repair/adjustment.
- Do not block any of the combi's openings.
- Do not adjust or repair the door.
- Do not install the combi outdoors or near water (e.g., sink, damp basement, pool).
- When cleaning oven surfaces where the door contacts the chassis, use mild, nonabrasive soap applied to a sponge or soft cloth. Unplug the combi before cleaning.
- To reduce the risk of fire in the oven, do not overcook food.
- Monitor cooking if combustible material (e.g., paper, plastic) is used to facilitate cooking. Remove wire twist-ties from bags before placing the bags in the microwave.
- If there is an oven fire, leave the door closed, turn off the oven, and shut off power at the fuse box or circuit-breaker panel.
- Do not use either oven for storage.
- Do not put oversized foods or metal utensils in the microwave, as they may cause a fire or electric shock.
- Do not clean with metal scouring pads. Pieces can come off the pad and touch electrical parts creating an electric-shock hazard.
- Do not cover the racks or any part of either oven chamber with foil.

Important safety information

- Water, milk, coffee, tea, etc. can be "superheated" (heated beyond the boiling point without bubbling). THIS COULD RESULT IN VERY HOT LIQUIDS SUDDENLY BOILING OVER WHEN THE CONTAINER IS DISTURBED OR A UTENSIL IS PUT IN THE LIQUID. To reduce the risk of injury:
 - Do not overheat liquid.
 - Stir liquid before and halfway through heating.
 - Do not use straight-sided, narrow-necked containers.
 - After heating, leave liquids in the microwave briefly before removing.
 - Use extreme care when putting a utensil in a container of heated liquid.

For your safety

When using electrical appliances, follow basic safety precautions, including:

CAUTION

Possible hot surfaces include oven vents and nearby surfaces, and door crevices.



Proper installation - Be sure the combi is properly installed and grounded by a qualified technician.



User servicing - Do not repair/replace any part of the combi except as instructed in this guide. All other service should be done by a qualified technician. Always disconnect power to the appliance before servicing by removing the fuse or switching off the circuit breaker.

Important safety information

- ☒ • Do not leave children unattended around the combi when it is in use.
- Do not use the combi as a space heater.
- Do not use water on grease fires. Turn off the oven, and smother the flames by closing the door or use a dry-chemical, baking-soda, or foam-type extinguisher.
- Avoid scratching/striking the glass doors and control screen. Do not use the oven if the glass is broken.
- If there is an oven fire during self-cleaning, turn the oven off, and wait for the fire to die. Do not force the door open. Introducing fresh air at self-cleaning temperatures may cause flames to burst from the oven, causing severe burns.
- If you notice oil residue in the oven, self-clean the oven before using it again. Such residue is a fire hazard.
- Wipe up heavy soil on the oven floor with a paper towel or rag before self-cleaning. Self-cleaning with heavy soil on the oven floor requires longer cleaning cycles and produces more smoke.
- ★ • Do not store flammable items in the ovens. Remove all packing material before operating the combi. Keep flammable items away from hot oven surfaces.
- Do not wear loose-fitting or hanging garments while using the combi.
- To avoid steam burns, use only dry potholders. Do not let potholders touch hot heating elements. Do not use a towel or other bulky cloth as a potholder.
- Teach children not to play with the controls or any other part of the oven.
- Do not use high-pressure water or steam-jet cleaners on any part of the combi.
- The combi should not be used by anyone of reduced physical, sensory, or mental capacity, or lack of experience and knowledge, unless supervised by a responsible party.

Electrical safety

- ★ • The combi should be serviced only by qualified personnel. Repairs by unqualified individuals may cause injury or malfunction, and void the warranty. For repairs, contact a Dacor-authorized service center.
- Flush-mounted appliances should be operated only after installation in cabinets that conform to relevant standards to ensure safety compliance.
- If the combi malfunctions or if fractures/cracks/splits appear, switch off the oven, remove power at the circuit breaker or fuse box, and contact a Dacor service center.

Important safety information

WARNING

Turn off the combi before replacing the lamp to avoid possible electric shock.

Child safety

WARNING



- Young children should not use the combi without supervision by a responsible adult.
- Do not let children play with any part of the combi.
- Keep children away when opening or closing the door to avoid possible injury.

During self-cleaning, the surfaces may get hotter than usual. Do not let children near the combi during self-cleaning mode.

WARNING



Oven surfaces may become hot during use. Keep children away during use.

Oven

-  • Heating elements may be hot even if dark in color. Inner oven walls become hot enough to cause severe burns. Outer surfaces can also become hot enough to cause burns. Do not touch or let clothing or other flammable material touch oven surfaces unless you are sure the oven is cool.
- Do not heat sealed food containers. Built-up pressure may burst the container and cause personal injury.
- Do not use the oven to dry paper products.
- Do not use the oven chambers for storage.
- Do not touch or let foil or a meat probe touch the heating element during use.
- Do not clean the oven glass with abrasive cleaners or sharp, metal scrapers. They can scratch the surface and weaken the glass.
-  • Be careful opening the door. Let hot air or steam escape before taking food from or putting food in the oven.
- Do not cover any part of the oven chamber with aluminum foil. Doing so hinders performance and is an electric shock and fire hazard.
- Arrange oven racks when the oven is cool. If a rack must be moved when hot, use potholders. Do not let the potholders touch the oven's heating element.

Important safety information

Cleaning the oven

-  Do not clean the door gasket. The gasket keeps heat from escaping the oven chamber. Do not rub, damage, or move the gasket.
- 
 - Birds are sensitive to the fumes released during an oven self-clean cycle. During self-cleaning, move birds to a well-ventilated room.
 - Before a self-cleaning cycle, remove all accessories and food, then wipe up any residue to prevent possible smoke and fire during the cycle.
 - Do not use commercial oven cleaner or oven liner in/on the oven.
 - If self-cleaning mode malfunctions, turn the oven off, and have it serviced by a qualified technician.

Critical cleaning warnings

CAUTION

- 
 - Do not clean the combi with benzene, alcohol, or other harsh substance. Doing so may discolor or deform the combi, or cause an electric-shock or fire hazard.
 - Clean the combi carefully. Sharp edges may cause personal injury.
 - Do not clean the combi with a steam cleaner. Doing so may cause corrosion.
 - Regularly clean the oven chamber. Food residue can damage the paint and impede oven function.

Important safety information

Critical usage warning



CAUTION

- ★ • If the combi is flooded, contact your Dacor service center. Flooding is an electric-shock or fire hazard.
- If the combi emits a strange noise, burning smell, or smoke, remove power at the circuit breaker immediately, and contact a Dacor service center.
- Do not touch the oven door, heating element, or other hot surfaces during or just after cooking.
- In case of oven fire, leave the door closed, turn the oven off, and shut off power at the fuse box or circuit-breaker panel.
- To avoid product damage, personal injury, or voiding the warranty, do not repair the oven yourself. Contact an authorized Dacor service center for repairs.
- Using the combi when it is contaminated by food and oil residue may cause a malfunction.
- Carefully remove wrapping from freshly cooked food. Steam may billow out abruptly causing severe burns.
- Do not turn the appliance off while an operation is in progress; doing so may result in electric shock or fire.
- Anyone of reduced physical, sensory, or mental ability must be supervised when using the combi.
- Do not let children play with the combi's controls.
- Do not touch the inside of the combi immediately after cooking.
- Do not use or keep flammable substances near the oven.
- Do not put fingers, foreign substances, or metal objects in any oven orifice. If a foreign substance is lost in any of these holes, contact a Dacor service center.
- Do not tamper with the combi doors, or remove the doors or oven shell.
- Do not store or use the combi outdoors.
- Use the combi only for cooking tasks consistent with a household kitchen. Any other usage is a fire hazard.
- Do not heat sealed containers. Make a hole in food items that have shells (e.g., eggs, chestnuts) with a knife before cooking.
- Do not cook with plastic/paper containers; such containers are a fire hazard.
- Do not heat food wrapped in magazines, newspapers, etc.
- Do not strike or apply excessive pressure to the doors or oven chambers.
- Do not hang on the door; the combi may fall and cause serious injury. Do not use the combi if the door is damaged. Contact a Dacor service center.
- Use oven mitts to handle food during or immediately after cooking and when touching hot oven surfaces to avoid burns.

Important safety information

Usage cautions

CAUTION

-  • If the combi exterior is cracked, turn it off to avoid electric shock.
- Remove lids from baby-food jars before heating. Afterward, stir to distribute the heat evenly. Always taste the food for hotness before feeding the baby.
- Stir drinking liquids during and after heating.
- Avoid heating a slippery container with a narrow neck.
- Leave the container in the microwave 30 seconds or more after heating to avoid an abrupt overflow that would cause burns.
- To avoid an electric-shock hazard, do not operate the combi with wet hands.
-  • Do not spray volatile substances directly on the appliance. Doing so may cause respiratory problems, electric shock, and product malfunction.
- Do not put your face or body close to the appliance while cooking or when opening the door just after cooking.
- Keep children away from the combi when it is in use.
- Do not abruptly cool the door, oven chamber, or a dish by pouring water over it during or just after cooking. The combi may be damaged, and the steam or water spray may cause burns.
- Do not turn the combi on when it is empty except for self-cleaning.
- Do not defrost frozen beverages in narrow-necked bottles, which may break.
- Open/close the door carefully to avoid pinching fingers.
- The door has wires at the bottom for connecting LEDs. Be careful not to pull or cut the wires when handling the door.

Introducing your new oven

Overview

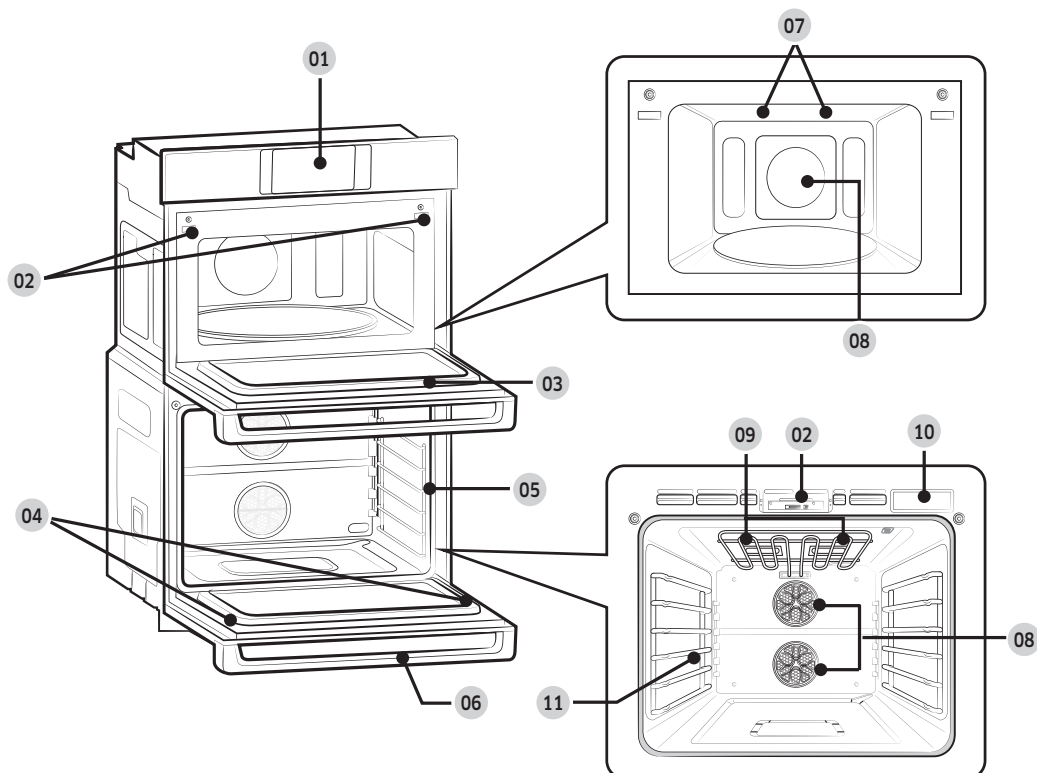

01 Control panel

02 Door latch

03 MWO door

04 Door LED light

05 Oven gasket

06 Oven door

07 LED lamp

08 Convection fan

09 Halogen lamp

10 Water reservoir

11 Rack support

What's included with your oven

This oven ships with different kinds of accessories that help you cook what you want.

Accessories for the oven

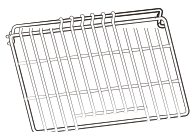

Wire rack (1)

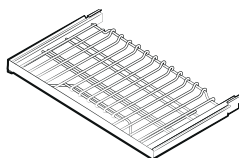

Gliding racks (2)

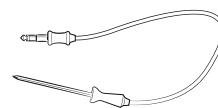

Temp probe (1)

| | |
|---------------|--------------------------------------------------------------------------------------------------------|
| Wire rack | Use these racks in the lower oven when baking and broiling |
| Gliding racks | These extend completely out of the oven for safe and easy handling and lifting of large/heavy cookware |
| Temp probe | Lets you cook meat to an exact internal temperature |

Accessories for the microwave

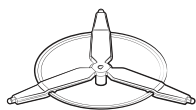

Roller ring



Optitray



Even plate

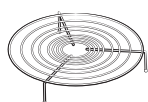

Low rack

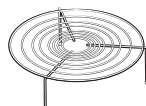

High rack

| | |
|-------------|--------------------------------------------------------------------------------------------------------------------------------------------------------------------------------------------|
| Roller ring | Put in the center of the base. It supports the optitray. |
| Optitray | Put on the roller ring with the center fitting of the coupler. It serves as a cooking base. |
| Racks | Use as appropriate to cook two dishes simultaneously; a smaller dish on the optitray, and the other on the selected rack. For Broil, Convection modes only (not for normal microwave use). |
| Even plate | Put on the optitray; browns food, keeps pastries/pizza crisp. |

NOTE

- Do not use the optitray without the roller ring.
- To purchase other accessories, call Dacor Customer Assurance (1-800-793-0093).

Before you begin

Before using the top and bottom ovens for the first time, remove all the accessories, and then clean the ovens thoroughly. Then, set the lower oven to Bake, and run it at 400 °F for 1 hour. Next, set the microwave (top) oven to Power Convection, and then run it at 400 °F for 1 hour. There will be a distinctive odor. This is normal.

Ventilate your kitchen well during this conditioning period.

Energy saving tips

- Keep the oven door closed except to turn food. Opening the door frequently during cooking lowers the oven temperature and wastes energy.
- If the cook time exceeds 30 minutes, you can turn the oven off 5-10 minutes before cooking ends to save energy. Residual heat completes the cooking process.
- Plan oven use so you do not have to turn the oven off between items.
- When possible, cook multiple items at once.

Optitray (For microwave oven)

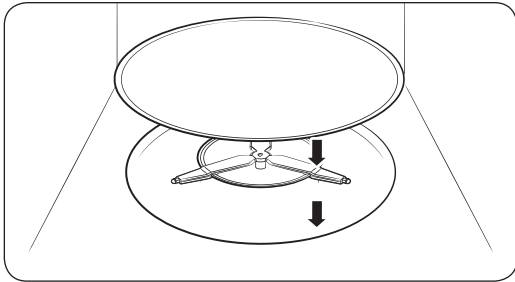

Remove all packing material from the oven chamber. Install the roller ring and optitray. Ensure the optitray rotates freely.

Before you begin

Water reservoir

This feature is for Steam Bake, Steam Roast, and GreenClean™ modes, and for removing water scale that forms on the oven walls after using these three modes. Fill the reservoir before steam cooking or descaling. The reservoir is on the oven's right side above the oven chamber.

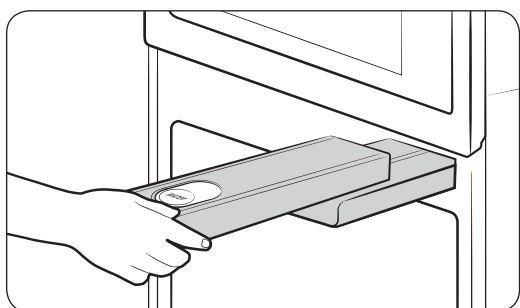
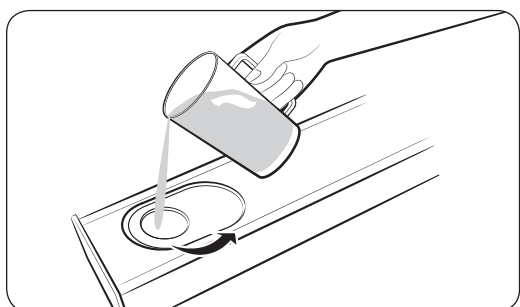
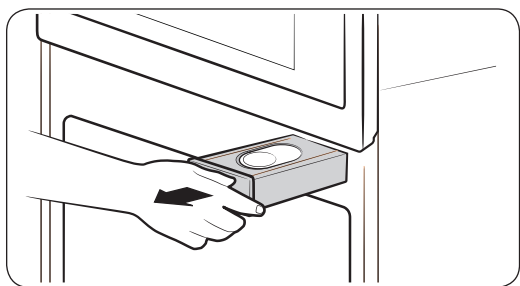

1. Open the oven door, and on the control screen, touch **Open/Close Reservoir**. The reservoir ejects. Pull it from the oven.
2. Open the reservoir cap (or clear plastic top), and fill the reservoir with 22 oz (650 ml) of drinkable water. (Do not exceed the **Max** line.)
3. Close the cap or clear top, and slide the water reservoir into its slot.
4. Push the reservoir to the end of its tray. You will feel a soft click. Touch **Open/Close Reservoir**. The reservoir retracts into place.
5. Close the oven door.

Basic operations

Control panel

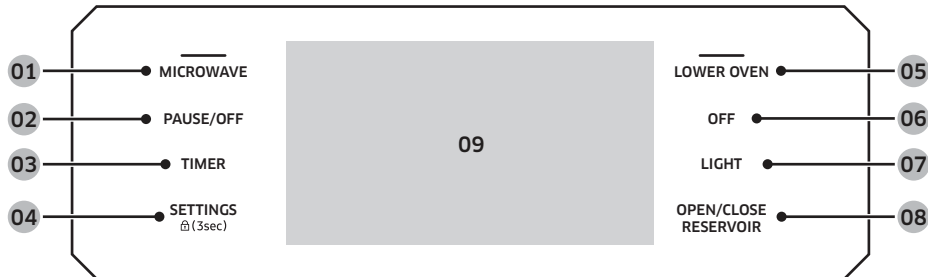

- 01 MICROWAVE:** Touch to display Microwave functions (does not turn the oven on/off).
- 02 PAUSE/OFF:** Touch to pause/cancel cooking in the microwave oven.
- 03 TIMER:** Touch to display the set Timer functions.
- 04 SETTINGS:** Touch to display oven-settings options. (Touch-hold for 3 seconds to disable oven functions.)
- 05 LOWER OVEN:** Touch to display lower-oven functions (does not turn the oven on/off).
- 06 OFF:** Touch to cancel cooking in the lower oven.
- 07 LIGHT:** Touch to turn the lower-oven light on/off.
- 08 OPEN/CLOSE RESERVOIR:** Touch to eject/retract the water reservoir.
- 09 Display:** Swipe to navigate the menus and tap to select a setting.

NOTE

Remove any sort of cook-preparation gloves to use the display.

Microwave

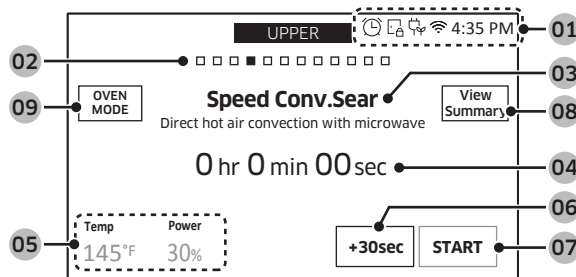

01 Indicator area

- **Timer (⌚):** When the timer is set, the timer indicator is displayed. When more than 2 timers are set, the number of set timers is shown.
- **Door lock (🔒):** Displayed when the oven door is locked.
- **Wi-Fi (📶):** Shows Wi-Fi signal strength in 5 steps.
- **12-hour energy saving (🕒):** Displayed when 12-hour energy saving is turned on.
- **Current time:** The current time is displayed.

- 02 Page Indicator:** Shows location of current mode.
- 03 Mode:** The current or selected menu appears with a mode description.
- 04 Cook Time:** Cook time appears. Tap this area to display the cooking time.
- 05 Information area:**
 - Temp.: The current/selected temperature appears. Tap this area to display the temperature adjustment screen.
 - Power: Microwave power level appears. Tap this area to display the power level adjustment screen.
- 06 +30sec:** Add 30 seconds to cook time before/during cooking.
- 07 START:** Tap to start the oven using the displayed settings.
- 08 View Summary:** Tap this area to display upper-/lower-oven cook modes.
- 09 OVEN MODE:** Tap this area to choose the upper oven mode.

Display (Oven)

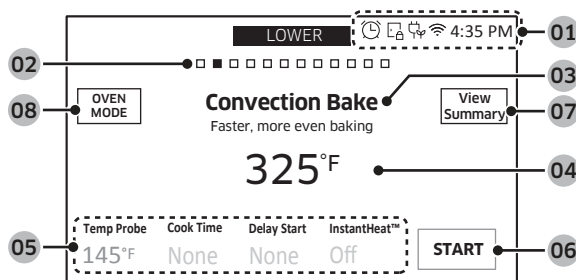

01 Indicator area

- **Timer** (⌚): When the timer is set, the timer indicator is displayed. When more than 2 timers are set, the number of set timers is shown.
- **Door lock** (🔒): Displayed when the oven door is locked.
- **Wi-Fi** (📶): Shows Wi-Fi signal strength in 5 steps.
- **12-hour energy saving** (🔋): Displayed when 12-hour energy saving is turned on.
- **Current time:** The current time is displayed.

02 Page Indicator: Shows location of current mode.

03 Mode: The current or selected menu is displayed with a mode description.

04 Temperature: The current or selected temperature is displayed. When you tap this area, the temperature adjustment screen is displayed.

Basic operations

05 Information area

- **Temp Probe:** The set temperature of the temp probe is displayed. When you tap this area, the Temp Probe screen is displayed.
- **Cook Time:** The cooking time is displayed. When you tap this area, the cooking time screen is displayed.
- **Delay Start:** The delay start time is displayed. When you tap this area, the Delay Start screen is displayed.
- **InstantHeat™:** Indicates if the InstantHeat™ feature is on or off. (Only displayed when you are using the Convection Bake or Convection Roast mode.)
- **Steam:** The steam level is displayed. When you tap this area, the steam level screen is displayed. (Only displayed when you are using the Steam Bake or Steam Roast mode.)

06 START: Tap to start the oven using the displayed settings.

07 View Summary: When you tap this area, cooking modes of upper and lower oven are displayed.

08 OVEN MODE: When you tap this area, you can choose the lower oven mode.

Control lockout

Control Lockout lets you lock the buttons on the touch pad so they cannot be activated accidentally. Control Lock locks only the lower oven door so it cannot be opened. You can only activate Control Lockout when the oven is in standby mode.

How to activate the control lockout feature

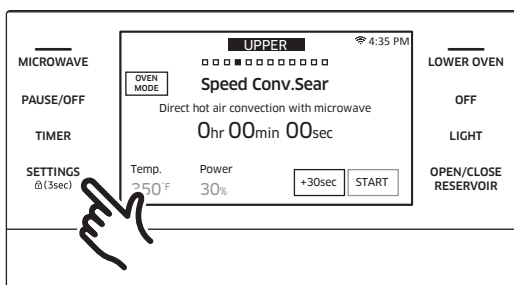

1. Cancel or turn off all functions.
2. Touch **SETTINGS** for 3 seconds.

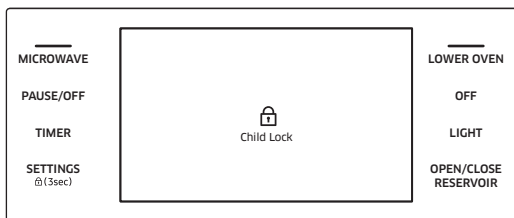

3. The display will change to the control lock screen and the control lock confirmation will appear at the bottom of the screen.

NOTE

- Control Lockout is available only when the oven temperature is under 400 °F.
- All other functions must be cancelled before you activate Control Lockout.

How to unlock the controls

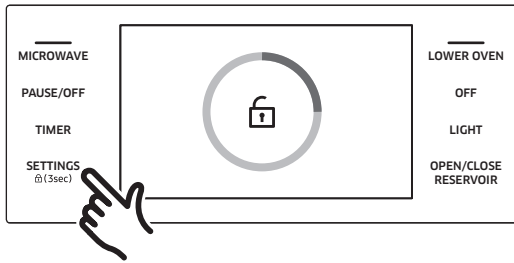

Touch **SETTINGS** for 3 seconds.

The control lock confirmation and the lock icon will disappear from the display.

NOTE

It may take up to 10 seconds for the doors to unlock.

Kitchen timer

The kitchen timer serves as an extra timer that will beep when the set time has elapsed. It does not start or stop cooking functions. You can use the kitchen timer with any of the other oven functions. You can set 10 timers maximum simultaneously. Each timer will count down independently of all the other active timers.

How to set the timer

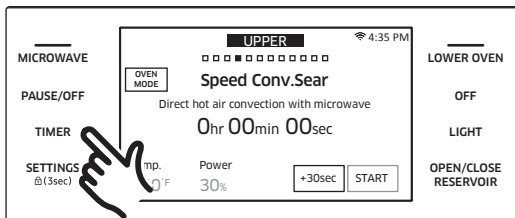

1. Touch **TIMER**.

The display will change to the timer screen.

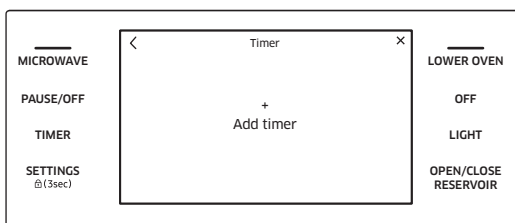

2. Tap + Add timer.

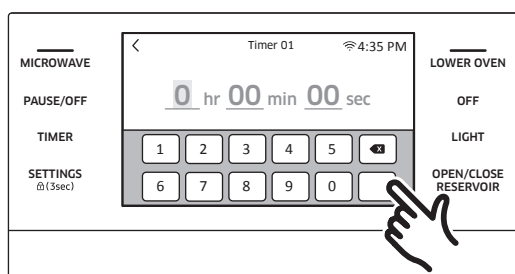

3. Tap the numbers in the numeric pad to set the timer. (You can set the timer for any amount of time from 1 sec to 23 hr 59 min 59 sec).
4. Tap **OK**.

Basic operations

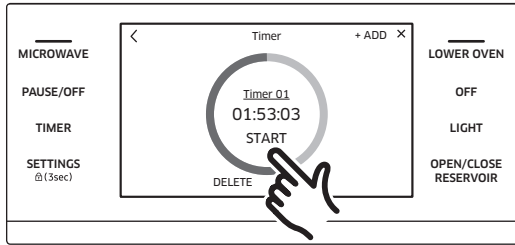

5. Tap START.

When the set time has elapsed, the oven will beep and the display will show the Timer has finished.

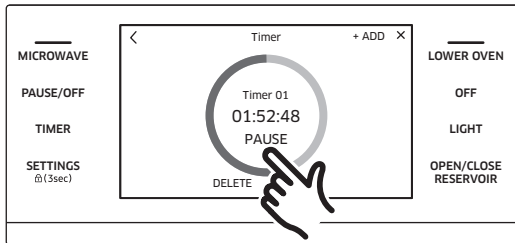

- You can pause, reset, or delete the timer at any time by tapping the screen.

NOTE

After you have performed Steps 1 to 5, you can return to Step 2 and set additional timers. You can also name timers so you can identify them separately. See below.

How to change the timer name

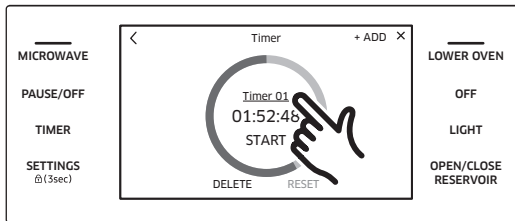

You can change the timer name to identify what you are timing, for example, a chicken defrosting.

- Tap the timer name area.
 - The keyboard appears.
- Enter the new timer name, and then tap **OK**.
 - The display shows the changed timer name.

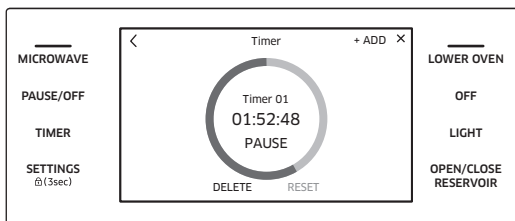
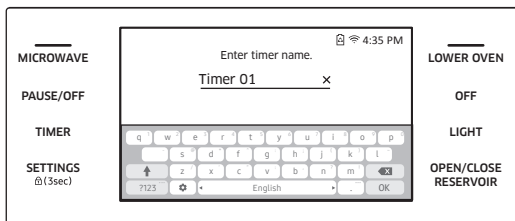

Basic operations

Minimum and maximum settings

Microwave (upper) oven

All the features in this table have min/max time, temperature, and power-level settings.

Tap MICROWAVE to select the cooking mode. Set the temperature or microwave power level via the numeric pad. See **Basic baking and broiling instructions** starting on pg. 61.

| Feature | | Temp./ Power range | Default Temp./ Power | Max. time |
|---------------------------------------------------------------------------------------------------------------------|--------------------------------------------------------------------------|-------------------------------------------------------------------------------------------------------------------------------------------------------------------------------|----------------------|---------------|
| Manual mode | Microwave | 10-100% | 100% | 1 hr. 30 min. |
| | | Microwave energy lets food be cooked/reheated without changing the form or color. | | |
| | Convection Sear | 100-450 °F (40-230 °C) | 350 °F | 2 hr. |
| | | Similar to Convection mode, but heating elements generate stronger heat and air currents inside the oven. Food cooks faster while retaining or improving the taste. | | |
| | Broil | - | - | 1 hr. 30 min. |
| | | For grilling food such as meat. | | |
| | Speed Conv.Sear | 100-450 °F (40-230 °C) 10-70% | 350 °F 30% | 1 Hr. 30 min. |
| Heating elements generate heat, which the fan distributes inside the oven, which is reinforced by microwave energy. | | | | |
| Speed Broil | 10-70% | 30% | 1 Hr. 30 min. | |
| | Heating elements generate heat, which is reinforced by microwave energy. | | | |
| Auto mode | Sense Cook™ | The 16 Sensor Cooking features have pre-programmed cook times. You do not need to set the cook times or power levels. | | |
| | Conv.Sear AutoCook | To accommodate first-time users of the Power Convection mode, the oven offers 20 auto programs. | | |
| | Healthy Fry | You do not need to set the cook time or power level; you can adjust the Healthy fry cook category as shown in this manual (see pg. 47); uses less oil than with an oil fryer. | | |
| | Defrost | The oven offers 4 defrosting programs. | | |
| | Healthy Choice | This menu has pre-set cooking programs for 38 items. You do not need to set the cook times or power levels. | | |
| | Auto Cook | For beginners, the oven offers a 69 auto-cooking programs. | | |
| | Soften/Melt | The oven offers 8 Soften/Melt programs. | | |

Microwave oven (Upper Oven)

Setting the power level

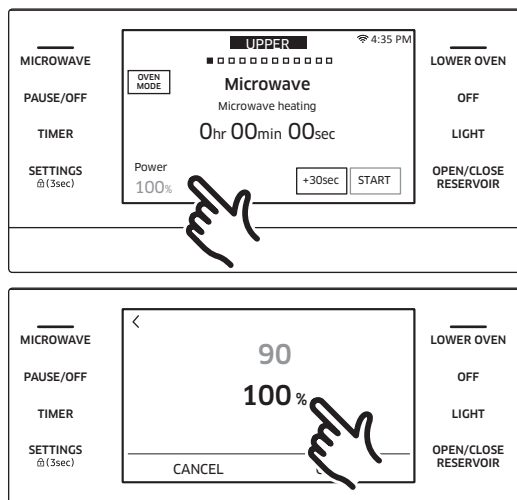

- Tap the **Power Level** area.
- Slide the screen or tap the wheel picker to set the power level. If you tap the wheel picker, the numeric pad will appear.

Timed cooking

In timed cooking mode, the oven turns on immediately and cooks for the length of time you select.

At the end of the cooking time, the oven turns off automatically.

- You can use the timed cooking feature only with another cooking operation. (Microwave, Convection Sear, Broil, Speed Conv.Sear, Speed Broil).

How to set the oven for timed cooking

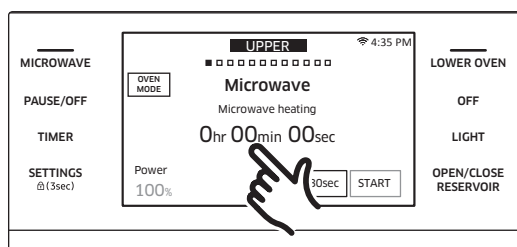

1. Tap **MICROWAVE** to select the cooking operation you want.
2. Tap **Cook Time**. The display will change to the cooking time screen.

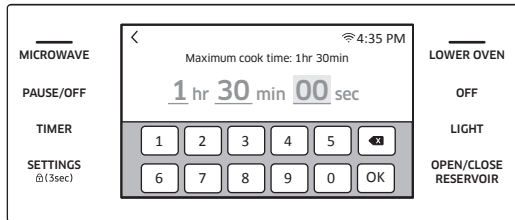

3. Tap numbers in the numeric pad to set the cooking time.

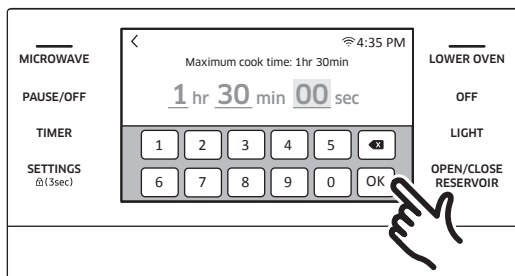

4. Tap **OK**. The cooking time screen closes.

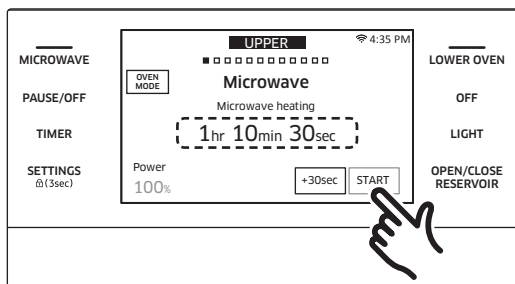

5. The cooking time is displayed in the **Cook Time** area on the screen.

6. Tap **START** to start cooking.

7. If you want to pause cooking, tap **PAUSE**. In **PAUSE**, you can cancel or continue cooking by tapping **OFF** or **CONTINUE**.

NOTE

See pg. 61 for basic baking and broiling instructions.

CAUTION

Use caution with the timed cooking features. You can use these features to cook cured or frozen meats and most fruits and vegetables.

For food that can easily spoil, such as milk, eggs, and thawed or fresh fish, meat, or poultry, chill them in the refrigerator first.

Even when chilled, they should not stand in the oven for more than 1 hour before cooking begins, and should be removed promptly when cooking is completed.

Eating spoiled food can result in sickness from food poisoning.

Microwave oven (Upper Oven)

Microwave

Microwaves are high-frequency electromagnetic waves that can be used to cook or reheat food without changing either the form or color of the food.

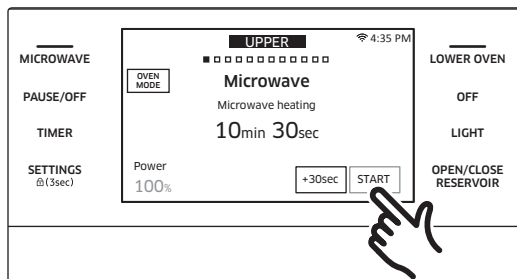
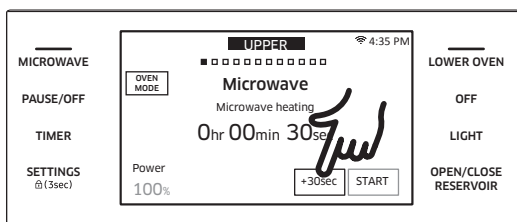
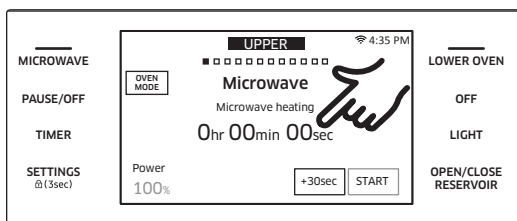
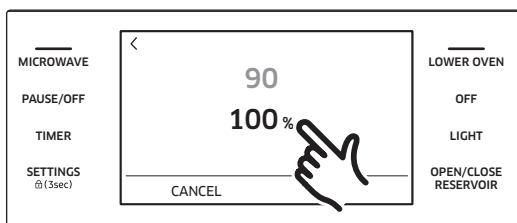
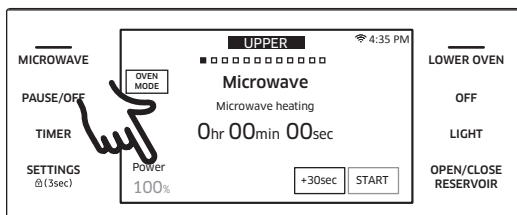

1. Put food in a microwave-safe container, and place the container in the center of the optitray. Close the door.
2. Tap **MICROWAVE** and swipe the screen to select **Microwave**.
3. Tap **Power**, and slide the screen or tap the wheel picker to set the power level. If you tap the wheel picker, the numeric pad will appear.
4. Tap **Cook Time**, and then use the number pad to input a desired cook time. You can also use the **+30sec** button to specify the cooking time.
5. Tap **START** to start cooking.
6. If you want to pause cooking, tap **PAUSE**. In **PAUSE**, you can cancel or continue cooking by tapping **OFF** or **CONTINUE**.

CAUTION

- Use only microwave-safe cookware.
- Use oven mitts when taking out food.

Power level

| | | | |
|------|---------------|-----|--------------|
| 100% | (High) | 50% | (Medium) |
| 90% | (Sauté) | 40% | (Medium low) |
| 80% | (Reheat) | 30% | (Low) |
| 70% | (Medium high) | 20% | (Defrost) |
| 60% | (Simmer) | 10% | (Warm) |

Convection Sear

Heat is evenly distributed inside the oven by the convection fan. Use a microwave rack, or a rack and even plate on the optitray. Use this mode for biscuits, individual scones, rolls, cakes, choux pastries, and soufflés.

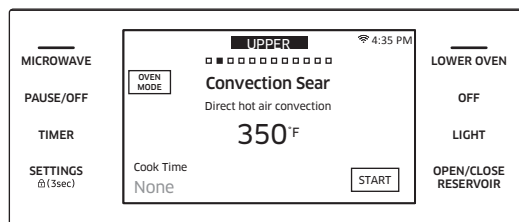

1. Put a rack, or rack and even plate on the optitray.
2. Tap **MICROWAVE**, swipe the screen, and select **Convection Sear**, then tap the temperature area. On the numeric pad, input a temp from 100 °F – 450 °F (default: 350 °F).

NOTE

To preheat, tap **START**.

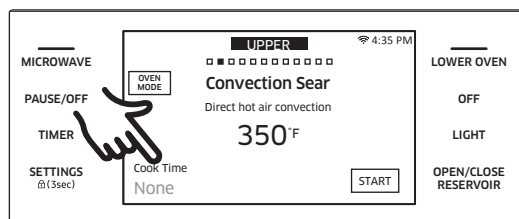

3. Tap **Cook Time**, then use the number pad to specify a cooking time.

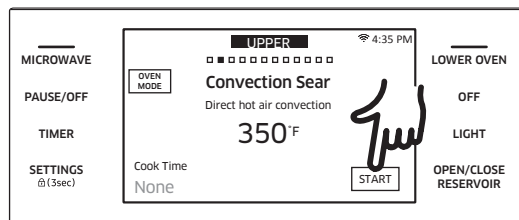

4. Tap **START** to start cooking.
5. If you want to pause cooking, tap **PAUSE**. In **PAUSE**, you can cancel or continue cooking by tapping **OFF** or **CONTINUE**.

Broil

For best performance, make sure all heating elements are in the horizontal position.

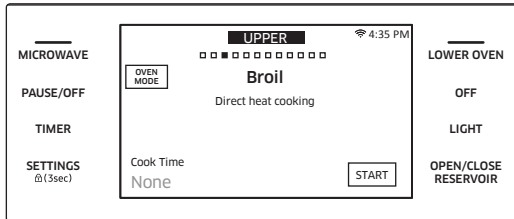

1. Put a rack or the combination of a rack and the even plate on the optitray.
2. Tap **MICROWAVE** and swipe the screen to select **Broil**. If preheating is preferred, simply tap **START**.

NOTE

You cannot set the temperature in **Broil** mode.

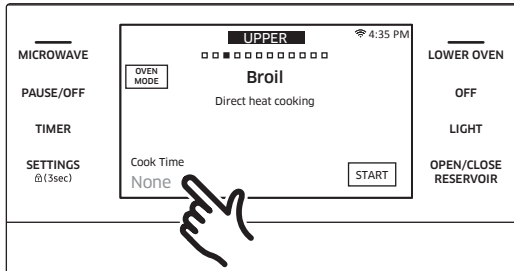

3. Tap **Cook Time**, and then use the number pad to specify a cooking time.

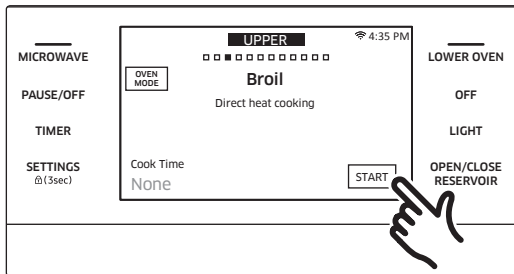

4. Tap **START** to start cooking.
5. If you want to pause cooking, tap **PAUSE**. In **PAUSE**, you can cancel or continue cooking by tapping **OFF** or **CONTINUE**.

CAUTION

- Use only microwave-safe cookware.
- Use oven gloves when taking out food.

Microwave oven (Upper Oven)

Speed Conv. Sear

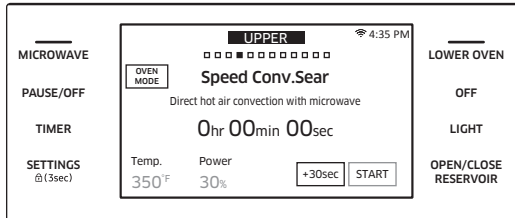

1. Put a rack or the combination of a rack and the even plate on the optitray.
2. Tap **MICROWAVE** and swipe the screen to select **Speed Conv.Sear**, and then tap the temperature area. The numeric pad will appear. You can input a desired temperature from 100 °F to 450 °F (default: 350 °F).

NOTE

To preheat, simply tap **START**.

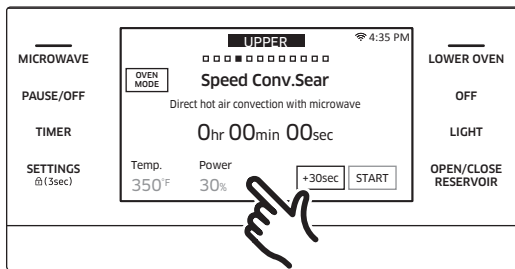

3. Tap **Power Level**, and then slide the screen or tap the wheel picker to specify a power level from 10% to 70%. If you tap the wheel picker, the numeric pad appears.

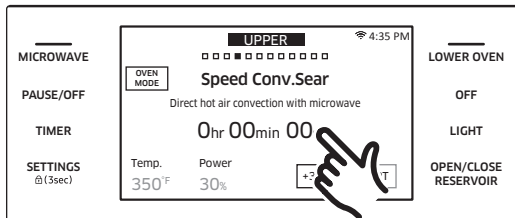

4. Tap **Cook Time**, and then use the number pad to specify a cooking time. You can also use the **+30sec** button to specify the cooking time.

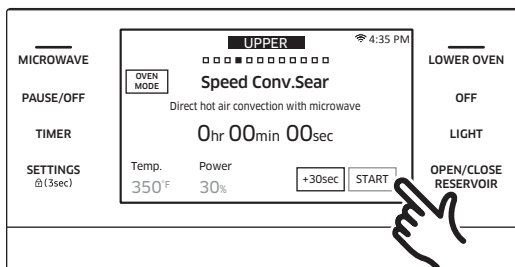

5. Tap **START** to start cooking.
6. If you want to pause cooking, tap **PAUSE**. In **PAUSE**, you can cancel or continue cooking by tapping **OFF** or **CONTINUE**.

CAUTION

Use only microwave-safe cookware, and use oven mitts when handling heated food.

Broil

The heating elements generate heat, which is reinforced by the microwave energy.

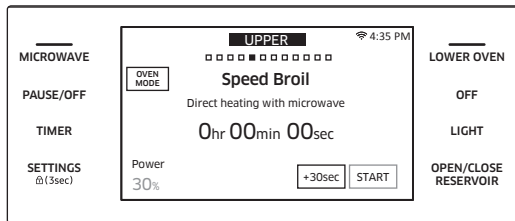

1. Put a rack or the combination of a rack and the even plate on the optitray.
2. Tap **MICROWAVE** and swipe the screen to select **Speed Broil**.

NOTE

You cannot set the temperature in Speed broil mode.

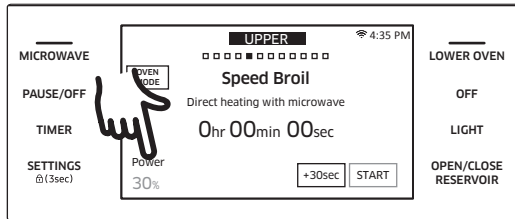

3. Tap **Power Level**, and then slide the screen or tap the wheel picker to specify a power level from 10% to 70%. If you tap the wheel picker, the numeric pad appears.

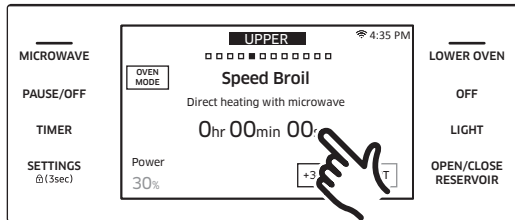

4. Tap **Cook Time**, and then use the number pad to specify a cooking time. You can also use the **+30sec** button to specify the cooking time.

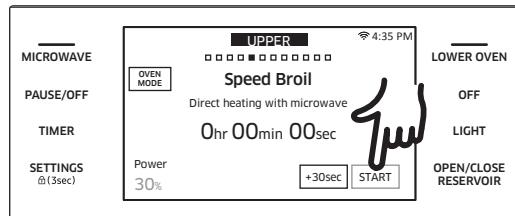
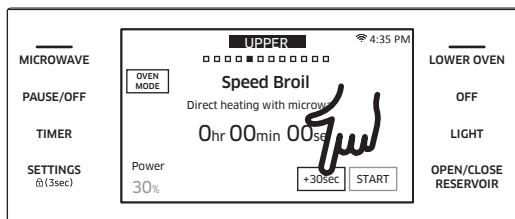

5. Tap **START** to start cooking.
6. If you want to pause cooking, tap **PAUSE**. In **PAUSE**, you can cancel or continue cooking by tapping **OFF** or **CONTINUE**.

CAUTION

Use only microwave-safe cookware, and use oven mitts when handling heated food.

Microwave oven (Upper Oven)

Sense Cook™

The oven offers 16 different Sense Cook™ options, which include pre-programmed cooking times. You do not need to set either the cooking time or the power level. Once you have selected a program and touched **START**, the oven automatically sets the cooking time and starts to cook. The gas-sensing animation effect shows the status of the sensing process.

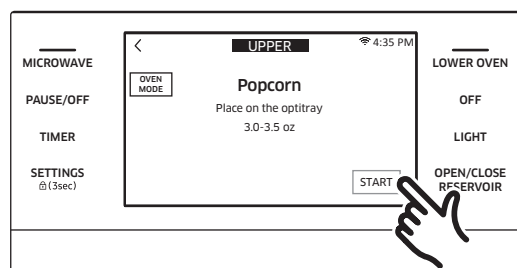
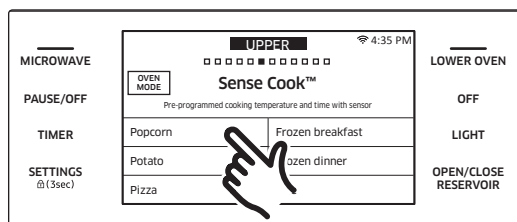
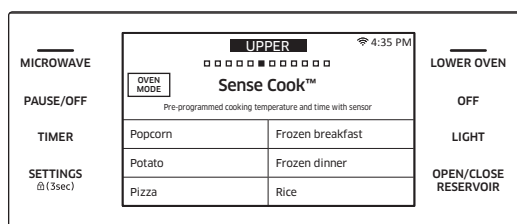

1. Put the food in the center of the optitray and close the door.
2. Tap **MICROWAVE** and swipe the screen to select **Sense Cook™**. The display will show 16 Sense Cook™ options. (You can scroll down through the list.)
3. Tap the **Sense Cook™** option you want.
4. Tap **START** to start cooking.
5. If you want to pause cooking, tap **PAUSE**. In **PAUSE**, you can cancel or continue cooking by tapping **OFF** or **CONTINUE**.

CAUTION

Use only microwave-safe cookware, and use oven mitts when handling heated food.

| Food | Amount | Instructions |
|--------------------|--------------------------------------------------------------------------------------------------------------------------|---------------------------------------------------------------------------------------------------------------------------------------------------------------------------------------------------------------------------|
| Popcorn | 3.0–3.5 oz 1 package | Use one microwave popcorn bag at a time; carefully remove bag from oven and when opening it. |
| Potato | 1–5 ea | Poke each potato several times with a fork; place on optitray in spoke-like fashion; let cooked potatoes stand 3–5 min.; let oven cool 5 min. or more before re-use. |
| Pizza | 1–4 slices | Place 1-4 pizza slices (wide ends out) on a microwave-safe plate; do not overlap or cover slices; let oven cool 5 min. or more before re-use. |
| Beverage | 6–8 oz | Use uncovered measuring cup/mug; after heating, stir well; let oven cool 5 min. or more before re-use. |
| Dinner Plate | Meal for 1 [3-4 oz. meat, poultry, or fish (6 oz. w/bone); ½ C starch (pasta, potatoes, rice, etc.); 3-4 oz. vegetables] | (Precooked, refrigerated foods only) Cover plate with vented (1-in. vent) plastic wrap or waxed paper tucked under plate; if food is not sufficiently warm after using Sensor function, heat again with added time/power. |
| Casserole | 1–4 servings Casserole (refrig'd) | Cover the plate with vented (1-in. vent) plastic wrap; if food is not sufficiently warm after using Sensor function, heat again with added time/power; stir food and serve. |
| Pasta | 1–4 servings Canned spaghetti | |
| Soup | 1–4 servings Soup (refrig'd) | |
| Frozen Breakfast | 4–8 oz | Frozen sandwiches, breakfast entrees, pancakes, waffles, etc.; follow package directions for covering/standing; let oven cool 5 min. or more before re-use. |
| Frozen Dinner | 13–18 oz | Remove wrapping; follow box directions covering/standing; let oven cool 5 min. or more before re-use. |
| Rice | 1–2 cups | In large, microwave-safe glass bowl, add 1½ cup cold water to 1 cup rice; cover with vented (1-in. vent) plastic wrap; rice doubles in size; when done cooking, stir, let stand, then salt or add herbs/butter. |
| Mini Ravioli | 8–14 oz | Spread mini ravioli in microwave-safe glass bowl; cover with vented (1-in. vent) plastic wrap; let stand 2–3 min; stir, serve. |
| Fresh Vegetables | 1–4 servings | Place vegetables in microwave-safe dish, and add 2–4 tbs. water; cover with vented (1-in. vent) plastic wrap, cook, stir, and let stand; let oven cool 5 min. or more before re-use. |
| Fresh Root Veggies | | |
| Frozen Vegetables | 1–4 servings | Place veggies in microwave-safe dish, and add 2–4 tbs. water; cover with vented (1-in. vent) plastic wrap, cook, stir, and let stand 3–5 min.; let oven cool 5 min. or more before re-use. |
| Canned Vegetables | 1–4 servings | Place veggies in microwave-safe dish. Cover with vented (1 inch vent) plastic wrap, cook, stir, let stand. Let the oven cool for at least 5 minutes before using it again. |

Microwave oven (Upper Oven)

Auto-sensor cooking

When food cooks, it emits various gases, by which Auto Sensor determines the proper time and power level, eliminating the need to set these two elements.

If a container is topped with a lid or plastic wrap, Auto Sensor detects the gases emitted when the container is saturated with steam.

NOTE

- If using cling film or plastic wrap, pierce the plastic with a knife/fork in several places.
- Shortly before cooking ends, turn or stir the food for even cooking if needed.
- Before cooking on Auto Sensor, add herbs, spices, or browning sauces; however, salt or sugar should be added after cooking to avoid burn spots.

Utensils & cover

- For best results with Auto Sensor, follow the directions for selecting proper containers/covers in the charts in this manual.
- Use microwave-safe containers covered with their lids or plastic wrap. (When using plastic wrap, turn back one corner so steam can escape.)
- Cover your microwave-safe dish/container with its lid, or use plastic wrap.
- Fill containers at least half full.
- Stir or turn food as needed, near the end of the Sense Cook cycle, after the display time starts to count down.

CAUTION

- You should not use Auto Sensor to cook one thing after another.
- For best results, use Auto Sensor when the room temperature is 45 °F to 90 °F.
- Do not use volatile detergents on the oven; the resulting gas may affect the sensor.

Microwave oven (Upper Oven)

Conv. Sear AutoCook

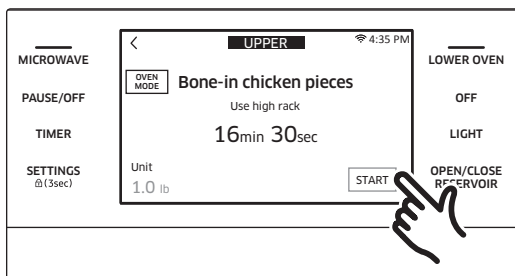
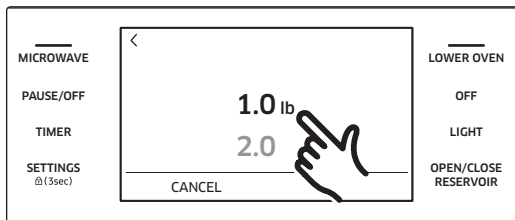
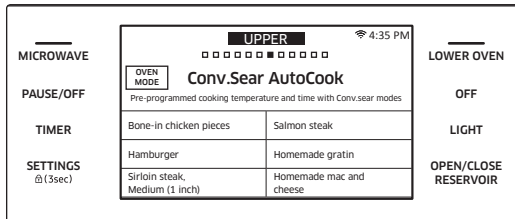

1. Put the food in the center of the optitray and close the door.
2. Tap **MICROWAVE** and swipe the screen to select **Conv.Sear AutoCook**.
3. Tap to select one of 20 different options.
4. Tap the weight area to select the food weight screen.
5. Slide the screen to select the food weight.
6. Tap **START** to start cooking.
7. If you want to pause cooking, tap **PAUSE**. In **PAUSE**, you can cancel or continue cooking by tapping **OFF** or **CONTINUE**.

CAUTION

- Use only microwave-safe cookware.
- Use oven gloves when taking out food.

| Food | Amount | Instructions |
|--------------------------------------|-----------------------------------|---------------------------------------------------------------------------------------------------------------------------------------------------------------------|
| Bone-in chicken pieces | 1.0 lb 2.0 lbs | Brush pieces with oil and seasonings; lay pieces skin side down on high rack; when microwave beeps, turn over bone-in pieces, then press START to continue. |
| Hamburger patties | 2 ea 4 ea (1 ea = 4 oz) | Put patties on "even" plate on high rack; when microwave beeps, turn patties, then press START to continue. |
| Sirloin steak, Medium (1 inch) | 1 inch 1.0 lb | Brush steaks with oil and seasonings, and lay on high rack; when microwave beeps, turn steaks, then press START to continue; let steaks rest 5 min. before slicing. |
| Sirloin steak, Well Done (1 inch) | | |
| Tenderloin steak, Medium (1 inch) | 1 inch 2 ea (1 ea = 1/2 lb) | |
| Tenderloin steak, Well Done (1 inch) | | |
| T-bone steak, Medium (1 inch) | 1 inch 1.5 lbs | |
| T-bone steak, Well Done (1 inch) | | |

Microwave oven (Upper Oven)

| Food | Amount | Instructions |
|-------------------------|---------------------------------|-------------------------------------------------------------------------------------------------------------------------------------------------------------------------------------------------------------------------------------------------------------------------------------------------------------------------------------------------------------------------------------------------------------------------------------------------------------------------------------------------------------------------------------------------------------------------------------------------------------------------------------------|
| Barbecue pork ribs | 1.0 lb 2.0 lbs | Brush ribs with bbq sauce, and lay them on low rack. |
| Boneless pork chops | 2 ea 4 ea (1 ea = 5-6 oz) | Brush chops with oil and seasonings, and lay them on high rack; when microwave beeps, turn chops, then press START to continue. |
| Salmon steak | 2 ea 4 ea (1 ea = 5-6 oz) | Brush salmon fillets with oil and seasonings, lay them on "even" plate, and put plate on high rack. |
| Homemade gratin | 20 oz 40 oz | Ingredients (40 oz): 25 oz potatoes; 4 oz milk; 4 oz cream; 1 egg (beaten); 1 tsp ea. salt, pepper, nutmeg; 5-6 oz grated mozzarella; butter; fresh thyme flakes. (For 20-oz recipe, use half of 40-oz quantities.) Peel and slice potatoes 1/8 in. thick. Spread slices on clean towel, and cover with towel. Rub cooking dish with butter. Put remaining ingredients (except cheese and thyme) in large bowl, and stir well. Layer potato slices slightly overlapped in dish, and pour liquid mix on top. Top with grated cheese, then put dish on low rack. When done, let stand 2-3 min. Sprinkle fresh thyme over top, and serve. |
| Homemade mac and cheese | 12 oz | Put oven dish on low rack and cook. |
| Frozen pizza (6 in.) | 6 inch | Put pizza on high rack. |
| Frozen pizza (12 in.) | 12 inch | Put pizza on low rack. |
| Frozen waffles | 2 ea 4 ea | Put waffles on "even" plate, put plate on low rack. |
| Frozen cheese sticks | 6 ea 12 ea | Put food on "even" plate, then put plate on high rack. |
| Frozen buffalo wings | 12 oz 16 oz | |
| Frozen potato chips | | |
| Frozen chicken nuggets | 8 oz 16 oz | |

Healthy Fry

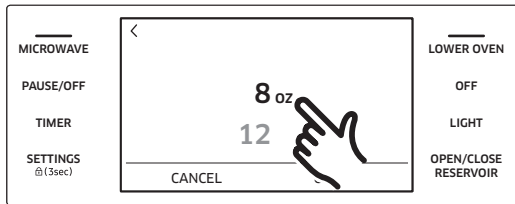
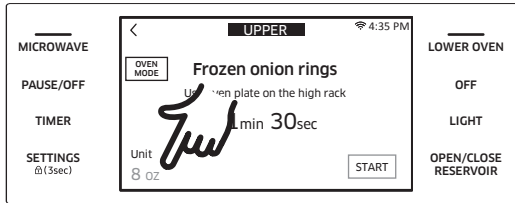
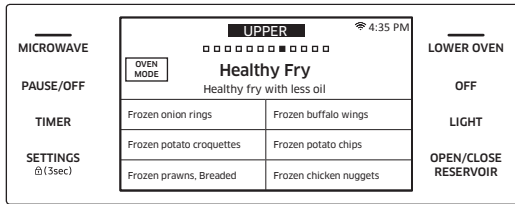

1. Put the food in the center of the optitray, and then close the door.
2. Tap **MICROWAVE** and swipe the screen to select **Healthy Fry**.
3. Tap to select one of 14 different options.
4. Tap the weight area to select the food weight screen.
5. Slide the screen to select the food weight.
6. Tap **OK**.
7. Tap **START** to start cooking.
8. If you want to pause cooking, tap **PAUSE**. In **PAUSE**, you can cancel or continue cooking by tapping **OFF** or **CONTINUE**.

CAUTION

Use only microwave-safe cookware, and wear oven mitts to handle heated food.

| Food | Amount | Instructions |
|--------------------------|--------|--------------------------------------------------------|
| Frozen onion rings | | Put food on "even" plate, then put plate on high rack. |
| Frozen fish cutlets | 8 oz | |
| Frozen prawns, breaded | 12 oz | |
| Frozen mini spring rolls | | |
| Frozen potato wedges | | |
| Frozen buffalo wings | 12 oz | |
| Frozen potato chips | 16 oz | |

Microwave oven (Upper Oven)

| Food | Amount | Instructions |
|--------------------------|----------------|----------------------------------------------------------------------------------------------------------------------------------------------------------------------------------------------------------------------------------|
| Frozen potato croquettes | 8 oz | Put food on "even" plate, then put plate on high rack. |
| Frozen chicken nuggets | 16 oz | |
| Frozen cheese sticks | 6 ea 12 ea | |
| Homemade french fries | 8 oz 12 oz | Peel potatoes and cut into 7/16" x 7/16" (10 x 10 mm) thick sticks; soak in salted, cold water 30-40 min; dry sticks well (to avoid sticking to tray), then brush with 1 tsp (5 g) oil; put sticks on "even" plate on high rack. |
| Drumsticks | 3 ea 6 ea | Rinse drumsticks and put them on "even" plate on high rack; when microwave beeps, turn drumsticks, then press START to continue. |
| Chicken wings | 10 ea 20 ea | Rinse wings, and put them on "even" plate on high rack. |
| Roasted vegetables | 8 oz 12 oz | Cut up vegetables, and brush them with 1 tsp (5 g) oil. Put vegetables on "even" plate on high rack. |

Defrost

There are 4 defrost options. Time and power levels adjust automatically with each option.

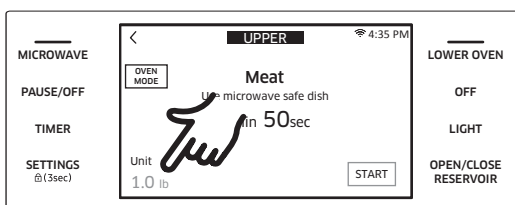
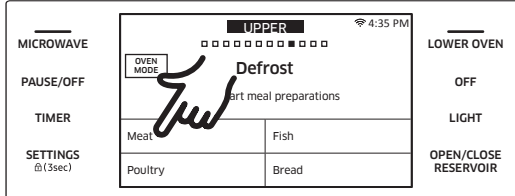
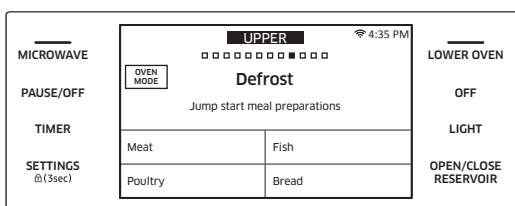

1. Put food in suitable cookware, then put the cookware on the optitray and close the door.
2. Tap **MICROWAVE** and swipe the screen to select **Defrost**. The display will show 4 defrost options.
3. Tap the **Defrost** option you want.
4. Tap the weight area to select the food weight.

Microwave oven (Upper Oven)

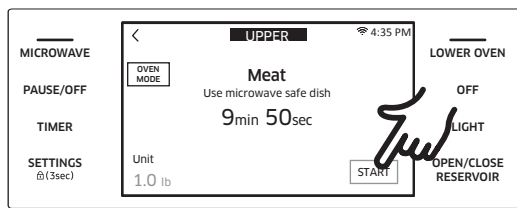
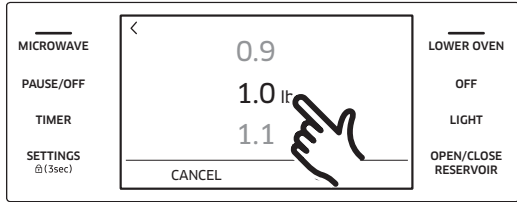

- Slide the screen or tap the number to select the food weight. If you tap the number, the numeric pad appears.
- Tap **OK**.
- Tap **START** to start defrosting.
- If you want to pause defrosting, tap **PAUSE**. In **PAUSE**, you can cancel or continue defrosting by tapping **OFF** or **CONTINUE**.

⚠ CAUTION

Use only microwave-safe cookware, and wear oven mitts when removing food.

| Food | Amount | Instructions |
|---------|-------------|----------------------------------------------------------------------------------------------------------------------------------------------------------------------------------------------------------------------------------------------|
| Meat | 0.1-3.5 lbs | Shield edges with foil; turn meat when oven beeps; use Meat for lamb, pork, steaks, chops, and ground meat (ground meat: place directly on optitray on wax paper; do not use extra tray); let stand, covered with foil, for 5–10 min. |
| Poultry | 0.1-3.5 lbs | Shield leg and wing tips with foil; turn poultry when oven beeps; use this program for whole chicken and chicken parts. |
| Fish | 0.1-3.5 lbs | Shield tail with aluminum foil; turn fish when oven beeps; use this program for whole fish and fillets. |
| Bread | 0.1-2.0 lbs | Put bread on ceramic plate and if possible, turn right when oven beeps; use this program for sandwich bread (sliced or whole), rolls (arrange in circle), and baguettes.. |

Healthy Choice

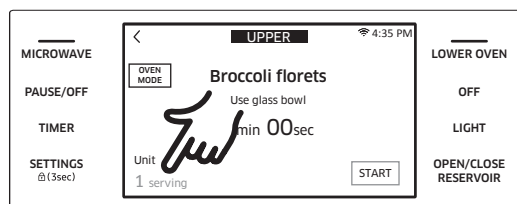
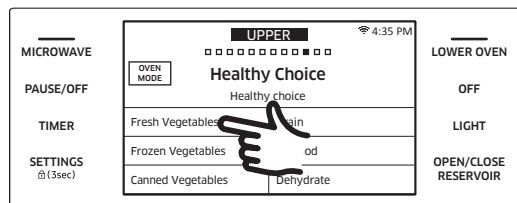

- Put the food in the center of the optitray and close the door.
- Tap **MICROWAVE**.
- Swipe the screen, and tap Healthy Choice. The display shows 6 menus that provide 38 Healthy Choice cook options. (You can scroll down the list.)
- Tap the serving area to display the servings of food screen.

Microwave oven (Upper Oven)

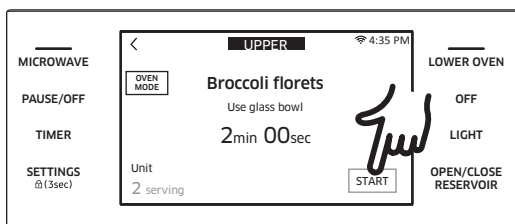
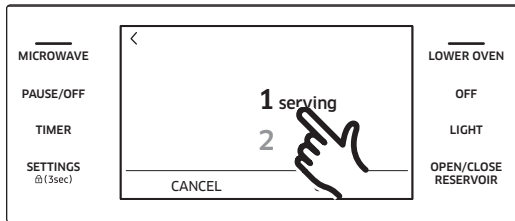

5. Slide the number to select the number of servings.
6. Tap OK.
7. Tap **START** to start cooking.
8. If you want to pause cooking, tap **PAUSE**. In **PAUSE**, you can cancel or continue cooking by tapping **OFF** or **CONTINUE**.

CAUTION

Use only microwave-safe cookware, and wear oven mitts when taking out food.

| Food | Amount | Instructions |
|-------------------------------|-----------------------------------|----------------------------------------------------------------------------------------------------------------------------------------------------|
| Fresh Vegetables | | |
| Broccoli, cauliflower florets | 1 – 4 servings (4 – 5 oz each) | Wash florets, and put in microwave-safe bowl; add 1 tbsp water/serving; cover while cooking; stir after. |
| Carrots | 1 – 4 servings (4 – 5 oz each) | Wash, cut into even slices, and put in microwave-safe bowl; add 1 tbsp water/serving; cover while cooking; stir after. |
| Green beans | 1 – 4 servings (4 – 5 oz each) | Wash beans; put beans in microwave-safe bowl; add 1 tbsp water/serving; cover while cooking; stir after. |
| Spinach | 1 – 4 servings (4 – 5 oz each) | Wash spinach; put spinach in microwave-safe bowl; add 1 tbsp water/serving; cover while cooking; stir after. |
| Zucchini | 1 – 4 servings (4 – 5 oz each) | Wash, slice zucchini, and put in microwave-safe bowl; add 1 tbsp water/serving; cover while cooking; stir after. |
| Eggplant | 1 – 4 servings (4 – 5 oz each) | Wash, slice eggplant, and put in microwave-safe bowl; sprinkle with 1 tbsp lemon juice; add 1 tbsp water/serving; cover while cooking; stir after. |
| Potatoes | 1 – 4 ea | Wash-clean potatoes; poke each several times with fork, and arrange on optitray in spoke-like fashion; after cooking, let potatoes sit 3–5 min. |

| Food | Amount | Instructions |
|------------------------------------------------------------------------|-----------------------------------|-------------------------------------------------------------------------------------------------------------------------------------------------------------------------------------------|
| Frozen Vegetables | | |
| Broccoli florets Carrots, Green beans, Peas, Mixed vegetables | 1 – 4 servings (4 – 5 oz each) | Put vegetables in microwave-safe bowl; add 1 tbsp water/ serving; cover while cooking; stir after. |
| Canned Vegetables | | |
| Carrots, Green beans, Peas, Spinach, Beans | 1 – 4 servings (4 – 5 oz each) | Put vegetables in microwave-safe bowl; cover while cooking; stir after. |
| Grain | | |
| Oatmeal | 1 pack 2 packs | Follow package directions for recommended amount of water; stir well before/after cooking. |
| Brown, white rice | 1 cup 2 cups | In large glass bowl, add 1 cup rice, then 2 cups cold water; cover with plastic wrap, and cut 1-in. vent in plastic; when done, stir, let stand, then salt or add herbs and butter. |
| Bulgur | ½ cup, 1 cup | Follow package directions for recommended amount of water; stir well, cook, then fluff with fork. |
| Quinoa | 1 cup, 2 cups | |
| Whole-wheat macaroni, couscous | 1 cup, 2 cups | Follow package directions for recommended amount of water; carefully remove from microwave; drain hot water. |
| Seafood | | |
| White fish fillet | 1 ea 2 ea | Put fillets (cod, pollack, etc.) on "even" plate; put plate on high rack; let sit 1-2 min. |
| Salmon fillet Tilapia fillet Tuna steak | 2 ea 4 ea (1 ea = 5-6 oz) | Put fillets on "even" plate; brush with oil/seasonings; put plate on high rack. |
| Dehydrated Food | | |
| Apple | 1 ea | Wash and cut in 1/8 – 1/2 in. slices; sprinkle with sugar- cinnamon mixture; put slices on low rack. |
| Pineapple | 1/2 ea | Peel, cut in 1/8 – 1/2 in. slices; put slices on low rack. |
| Banana | 2 ea | |
| Orange | 1 ea | Wash and cut horizontally in 1/8 – 1/2 in. slices; put slices on low rack. |
| Lime | 2 ea | |
| Potato | 1 ea | Wash, cut in 1/8 – 1/2 in. slices; season with salt; put slices on low rack. |
| Sweet Potato | 1 ea | Wash, cut in 1/8 – 1/2 in. slices; sprinkle with sugar; put slices on low rack. |

Microwave oven (Upper Oven)

Auto Cook

This mode offers a total of 69 cooking options on two menus. You do not need to set the cook time or power level, and you can adjust the serving size.

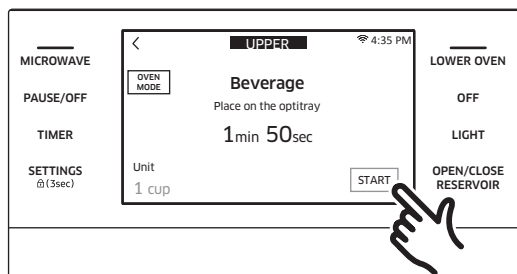
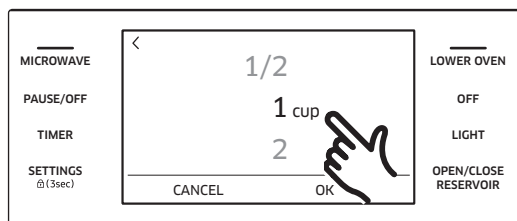
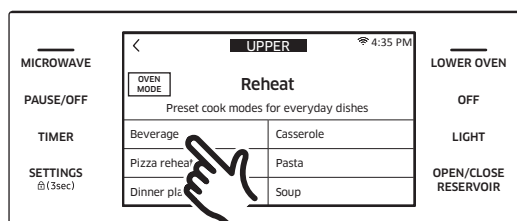
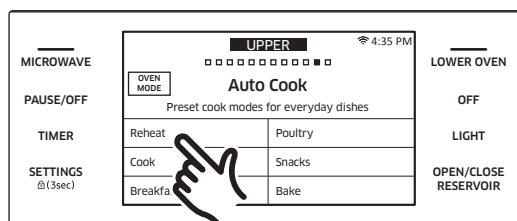

1. Center the food on the optitray, and close the door.
2. Tap MICROWAVE and swipe the screen to select Auto Cook. The display shows Speed Cook and Soften/Melt menus. Choose a menu, and scroll to view the auto cook programs.
3. Tap the desired Auto Cook option.
4. Tap the weight area to select the food weight screen.
5. Slide the screen to select the food weight.
6. Tap OK.
7. Tap START to start cooking.
8. If you want to pause cooking, tap PAUSE. In PAUSE, you can cancel or continue cooking by tapping OFF or CONTINUE.

 **CAUTION**

Use only microwave-safe cookware, and wear oven mitts to handle food/cookware.

| Food | Amount | Instructions |
|--------------------------|-----------------------------------------------|---------------------------------------------------------------------------------------------------------------------------------------------------------------------------------------------------------------------------------------------------------------------------------------------------------------------------------------------------|
| Reheat | | |
| Beverage | 1/2 cup 1 cup 2 cups | Use an uncovered measuring cup/mug; do not cover; put beverage in oven, heat, then stir well. |
| Pizza reheat | 1 slice 2 slices 3 slices 4 slices | Place 1-4 pizza slices crust-out on a microwave-safe plate; do not overlap slices; do not cover. |
| Dinner plate | 1 serving | Use precooked, refrigerated foods only; cover plate with vented (1-in. vent) plastic wrap or waxed paper tucked under plate. Sample meal: <ul style="list-style-type: none"> • 3-4 oz meat, poultry, or fish (up to 6 oz with bone) • 1/2 cup starch (potatoes, pasta, rice, etc.) • 1/2 cup vegetables (3-4 oz) |
| Casserole | 1 serving | Pour into deep ceramic plate/bowl; cover with vented (1-in. vent) plastic wrap; heat, stir well, serve. |
| Pasta | 2 servings | |
| Soup | 3 servings 4 servings | |
| Cook | | |
| Frozen dinner | 8-10 oz 11-14 oz 15-18 oz | Remove package from wrapping; follow package cooking directions; after cooking, let stand 1–3 min. |
| Frozen breakfast | 4-6 oz 7-8 oz | |
| Mashed potatoes, Instant | 2 servings 4 servings (1 svq = 1/2 cup) | Follow package directions to cook; stir well before serving. |
| Bacon, Uncooked | 2 ea | Layer 2 paper towels on microwave-safe plate; arrange the bacon on top without overlap; cover with another paper towel; remove the paper towel immediately after cooking. |
| Bacon, Pre-cooked | 4 ea 6 ea | |

| Food | Amount | Instructions |
|-------------------------------------|-----------------------------------|------------------------------------------------------------------------------------------------------------------------------------------------------------|
| Breakfast | | |
| Frozen french toast | 2 ea 4 ea | Place the french toast on the high rack. |
| French toast sticks | 6 ea 12 ea | Arrange food on even plate; put plate on low rack. |
| Sausage links, Frozen | 4 ea | |
| Sausage links, Fresh | 8 ea | |
| Frozen sandwich | | |
| Frozen waffles | 2 ea 4 ea | |
| Frozen bagels | | |
| Sausage patties, Frozen | 2 ea | Arrange food on even plate; put plate on high rack. |
| Sausage patties, Fresh | 4 ea | |
| Beef | | |
| Hamburger | 2 ea 4 ea (1 ea = 4 oz) | Place patties on "even" plate on high rack; when microwave beeps, turn hamburgers, and press START to continue. |
| Sirloin steak, Medium (1 inch) | 1.0 lb | Brush steaks with oil, season, then put on high rack; when microwave beeps, turn steak, and press START to continue; let steak rest 5 min. before slicing. |
| Sirloin steak, Well done (1 in.) | | |
| Tenderloin steak, Medium (1 in.) | 1 inch 2 ea (1 ea = 1/2 lb) | |
| Tenderloin steak, Well done (1 in.) | | |
| T-Bone steak, Medium (1 in.) | 1 inch | |
| T-Bone steak, Well done (1 in.) | 1.5 lbs | |

Microwave oven (Upper Oven)

| Food | Amount | Instructions |
|------------------------|-------------------------------------------|-----------------------------------------------------------------------------------------------------------------------------------------------------------------------------------------------------------------------------------------------|
| Beef | | |
| Meat loaf | 2.5 lbs | 1½ lbs ground beef, 1 egg, 1 onion (chopped), 1 C milk, 1 C dried bread crumbs, s/p to taste In large bowl, combine beef, egg, onion, milk, crumbs; season with s/p; put in lightly greased 5 x 9 in. microwave-safe loaf pan on low rack. |
| Roast beef | 2.0 lbs 3.0 lbs | Brush beef with oil, season, and put on low rack; when microwave beeps, turn roast, and restart microwave. |
| Pork | | |
| Barbecue pork ribs | 1.0 lb 2.0 lbs | Brush ribs with barbecue sauce, and put on low rack. |
| Boneless pork chops | 2ea 4ea (1 ea = 5-6 oz) | Brush chops with oil, season, and put on high rack; when microwave beeps, turn chops, and press START to continue. |
| Poultry | | |
| Bone-in chicken pieces | 1.0 lb 2.0 lbs | Brush chicken with oil, season, and put skin-side down on high rack; when microwave beeps, turn chicken, and press START to continue. |
| Whole chicken | 4.0 lbs 5.0 lbs | Brush chicken with oil, add spices, and center chicken breast-side down on low rack; when microwave beeps, turn chicken with tongs, and press START to continue; after cooking, let rest 2-3 min. |
| Chicken breast | 0.75 lb 1.5 lbs | Put poultry on high rack; after cooking, let rest 1-2 min. |
| Turkey breast | | |
| Snacks | | |
| Popcorn | 1.5 oz 3.0 oz 3.5 oz (1 package) | Use one popcorn bag at a time; carefully remove and open heated bag. |
| Hot dog | 2 ea 4 ea | Put hot dogs on "even" plate, poke 3 times with fork, and put on low rack; when microwave beeps, add buns, and press START to continue. |
| Nachos | 1 serving | Arrange 4-5 oz tortilla chips uniformly on microwave-safe plate, and put on high rack; sprinkle evenly with cheese 1/2 cup grated cheese. |

| Food | Amount | Instructions |
|-------------------------|----------------|------------------------------------------------------------------------------------------------------------------------------------------------------------------------------------------------------------------------------------------------------------------------------------------------------------------------------------------------------------------------------------------------------------------------------------------------------------------------------------------------------------------------------------------------------------------------------------------------------------------------------------------|
| Snacks | | |
| Baked potato | 2 ea 4 ea | Poke potatoes 3 times with fork; put potatoes on low rack; after cooking, let potatoes 3–5 min. |
| Frozen garlic bread | 6 ea | Put bread on "even" plate on low rack; when microwave beeps, turn bread, and press START to continue; after cooking, let rest 1–2 min. |
| Homemade gratin | 20 oz 40 oz | 40-oz: 25 oz potatoes; 4 oz milk; 4 oz cream; 1 whole egg (beaten); 1 tsp ea.: salt, pepper, nutmeg; 6 oz grated mozzarella cheese; butter; thyme. (For 20-oz recipe, halve the above quantities.) Prep: Peel and cut potatoes in 1/8-in. slices; spread slices on clean towel, and cover with towel; rub cooking dish with butter; put remaining ingredients (except grated cheese) in large bowl, and stir well; layer slices slightly overlapped in dish, and pour wet mix over top; sprinkle grated evenly cheese over top; put dish on low rack; after cooking, let rest 2–3 min; sprinkle sparingly with fresh thyme leaves. |
| Homemade lasagna | 40 oz | 3/4 lb ground beef, 2 tbsp olive oil, 8 oz tomato sauce, 4 oz beef stock, 8 lasagna sheets, 1 onion (chopped), oregano, and basil to taste, 8 oz grated mozzarella cheese Prep: Heat oil in skillet; cook ground beef and chopped onion ~10 min until browned; combine with tomato sauce and beef stock, then add dried herbs; bring to boil, then simmer 30 min.; cook lasagna noodles per package directions; layer noodles, then sauce, then cheese, and repeat; sprinkle remaining cheese evenly on top; put oven dish on low rack; after cooking, let rest 2–3 min. |
| Frozen soft pretzels | 2 ea 4 ea | Place the pretzels on the even plate, then place the plate on the low rack. |
| Frozen churros | 2 ea 4 ea | Place churros on "even" plate on high rack. |
| Homemade mac and cheese | 12 oz | Put oven dish on low rack. |
| Quesadilla | 1 ea 2 ea | Follow package directions; put quesadilla on "even" plate on low rack. |

| Food | Amount | Instructions |
|--------------------------|-------------------------|-------------------------------------------------------------------------------------------------------------------------------------------------------------------------------------------------------------------------------------------------------------------------------------------------------------------------------------------------------------------------------------------------------------------------------------------------------------------------------------------------------------------------------------------------------------------------|
| Toast Hawaii | 4 ea | Toast bread slices, then put toast with topping on high rack; after cooking, let rest 2–3 min. |
| Frozen lasagna | 1 serving 2 servings | Put frozen lasagna on low rack; let rest 2–3 min. |
| Potato bites | 5 ea 10 ea | Arrange food on "even" plate on high rack. |
| Egg rolls | 10 ea 20 ea | |
| Bake | | |
| Box cake mix | 1 pack | Pour batter in 8-in. round cake pan; put pan on low rack. |
| Brownie mix | 1 pack | Pour batter in 8 x 8-in. pan; put pan on low rack. |
| Cookie dough, Frozen | 8 ea | Put 8 cookies on "even" plate on low rack. |
| Cookie dough, Chilled | | |
| Biscuits | 8 ea | <p>2 1/2 cups a-p flour, 1 tbsp baking powder, 1 tbsp sugar, 1 tsp salt, 5 tbsp unsalted butter (cold), 1 C buttermilk</p> <p>Prep:</p> <ol style="list-style-type: none"> 1. Combine all ingredients except buttermilk in food processor, and pulse ingredients together; pour into large bowl, and mix in buttermilk. 2. On lightly floured surface, hand press dough to 1/2-in thickness; press and fold dough 4 times into rectangle. 3. Cut dough into 8 round pieces; place on "even" plate 1 inch apart; put plate on low rack. |
| Cinnamon rolls | 1 ea | <p>Dough: 1/4-oz packet yeast, 1/2 C warm water, 1/2 C milk, 1/4 C granulated sugar, 4 tbsp butter (melted), 1 tsp salt, 2 eggs, 4 C a-p flour</p> <p>Filling: 4 tbsp butter (softened), 1/2 C brown sugar, 2 tbsp cinnamon, 1/2 C raisins, 3/4 C chopped pecans (optional)</p> <p>Icing: 8 oz cream cheese (softened), 4 tbsp butter (softened), 1 tsp vanilla extract, 3/4 C powdered sugar</p> |

Microwave oven (Upper Oven)

| Food | Amount | Instructions |
|------------------------|--------|-------------------------------------------------------------------------------------------------------------------------------------------------------------------------------------------------------------------------------------------------------------------------------------------------------------------------------------------------------------------------------------------------------------------------------------------------------------------------------------------------------------------------------------------------------------------------------------------------------------------------------------------------------------------------------------------------------------------------------------------------------------------------------------------------------------------------------------------------------------------------------------------------------------------------------------------------------------------------------------------------------------------------------------------------------------------------------------------------------------------------------------------------------------------------------------------------------------------------------------------------------------------------------------------------------------------------------------------------------------------------------------------------------------------------------------------------------------------------------------------------------------------------------------------|
| Cinnamon rolls | 1 ea | <p>Dough: 1/4-oz packet yeast, 1/2 C warm water, 1/2 C milk, 1/4 C granulated sugar, 4 T butter (melted), 1 t salt, 2 eggs, 4 C a-p flour</p> <p>Filling: 4 tbsp butter (softened), 1/2 C brown sugar, 2 tbsp cinnamon, 1/2 C raisins, 3/4 C chopped pecans (optional)</p> <p>Icing: 8 oz cream cheese (softened), 4 tbsp butter (softened), 1 tsp vanilla extract, 3/4 C powdered sugar</p> <p>Prep:</p> <p>Dough</p> <ol style="list-style-type: none"> 1. In small bowl, dissolve yeast in warm water, set aside; in large bowl, mix milk, melted butter, eggs, sugar, salt, then add dissolved yeast and flour, and mix until dough forms. 2. Place dough on lightly floured surface, knead 5 min., then put in greased bowl, cover, and let rise 1 hr. <p>Filling</p> <ol style="list-style-type: none"> 1. On lightly floured surface; roll dough to 9 x 13 inches. 2. In small bowl, mix cinnamon and sugar; spread softened butter over dough, then sprinkle even layer of cinnamon-sugar, then even layer of raisins and pecans. 3. From long side, roll dough into log; pinch-seal dough, and cut in 1-in. slices. 4. Put slices in greased 9 x 13 in. baking pan; let rise 1 hr. 5. Put pan on low rack; press START. <p>Icing</p> <ol style="list-style-type: none"> 1. In large bowl, blend cream cheese, butter, and vanilla until fluffy; add sugar, and blend until smooth. 2. Spread over semi-cooled cinnamon rolls. |
| Chocolate chip cookies | 8 ea | <p>16 cookies:</p> <p>1 1/4 C a-p flour, 1/2 tsp baking soda, 1/4 tsp salt, 1/2 C butter (softened), 1 tsp vanilla extract, 1/4 C ea. granulated and brown sugar, 1 egg, 1 C semi-sweet morsels</p> <ol style="list-style-type: none"> 1. In large bowl combine flour, baking soda, and salt; in another large mixing bowl, beat butter, vanilla, both sugars until creamy; mix in eggs; blend in flour mix fully, then mix in chocolate morsels. 2. Scoop about 2 tbsp dough each, and put on "even" plate 2 in. apart; put plate on low rack. |
| Oatmeal raisin cookies | 8 ea | <p>3/4 C a-p flour; 1/2 tsp each: baking soda, baking powder, ground cinnamon; 1/4 tsp salt, 1/2 C butter (softened); 1 tsp vanilla extract; 1/4 C each: granulated sugar, brown sugar; 1 egg, 1 1/2 C oats, 1/2 C raisins</p> <ol style="list-style-type: none"> 1. In large bowl, mix flour, baking soda, baking powder, cinnamon, and salt; in another large bowl, beat butter, vanilla, and both sugars, then mix in eggs; add flour mix, combining until dough forms, then mix in oats, raisins. 2. Scoop about 2 tbsp dough each, and put on "even" plate 2 in. apart; put plate on low rack. |

| Food | Amount | Instructions |
|-----------------------------------|--------|----------------------------------------------------------------------------------------------------------------------------------------------------------------------------------------------------------------------------------------------------------------------------------------------------------------------------------------------------------------------------------------------------------------------------------------------------------------------------------------------------------------------------------------------------|
| Cupcakes | 6 ea | Put batter in 6-cup pan on low rack. |
| Marble cake | 1 ea | Put batter in round cake pan on low rack; after baking, let rest 5-10 min. |
| Cheese cake | 1 ea | 15 graham crackers (crushed); 1/2 C butter, 14 oz cream cheese (softened), 2 eggs, 1 C sugar, 1 tsp vanilla extract 1. Melt butter in pan; add crushed crackers, and stir to coat crackers; spread evenly in 8-in. tin, and press down firmly. 2. Mix cream cheese, eggs, sugar, and vanilla until smooth; pour over base, and even out with spatula. 3. Place tin on low rack, bake, let cool, chill 5 hours, serve. |
| Pound cake | 1 ea | Ingredients: 1 1/3 sticks butter (softened), 2/3 C sugar, 3 eggs, 2 C a-p flour, 3/4 tsp baking powder, 2/3 C milk, 1 1/3 tsp vanilla extract 1. In large bowl mix butter and sugar; add eggs, and mix until smooth; mix in remaining ingredients. 2. Pour batter into greased cake pan; put pan on low rack. |
| Pizza | | |
| Frozen (6") | 6 in. | Place pizza on high rack. |
| Frozen (12"), frozen rising crust | 12 in. | Place pizza on low rack. |
| Homemade | 12 in. | Dough: 10 oz strong white bread flour; 1/4 oz dried yeast; 1 tbsp ea: olive oil, sugar, salt; 7 oz warm water Topping: 4 tbsp pizza sauce; meat, vegetables as desired; 5 oz grated mozzarella cheese 1. In large bowl, mix flour, yeast, oil, salt, warm water to a moist dough; knead in mixer or by hand 5-10 min.; cover and proof with 'Pizza dough' auto cook menu. 2. Roll out into crusty plate; spread sauce on dough; add toppings; sprinkle cheese evenly on top; put pizza on low rack; cook; let rest 2-3 min. |
| Dough Proof/Yogurt | | |
| Pizza/bread dough | 1 ea | Put dough in suitable bowl, and cover with plastic wrap. |
| Yogurt - Small cups | 5 ea | Put 1 oz natural yogurt each in 5 ceramic cups or glass jars; add 1/2 C long-life milk (room-temp, 3.5 % fat) to each cup; cover with plastic wrap, and arrange in circle on optitray; when finished, chill 6 hr; for initial use, you should use dried yogurt bacteria ferment. |
| Yogurt - Large bowl | 16 oz | Mix 5 oz natural yogurt with 2-3 cups long-life milk (room-temp, 3.5 % fat); pour into large glass bowl, cover with plastic wrap, and set on optitray; when finished, chill 6 hr; for initial use, you should use dried yogurt bacteria ferment. |

Soften / Melt

The oven offers 8 different Soften/Melt options. You do not need to set either the cooking time or the power level. You can adjust the size of serving.

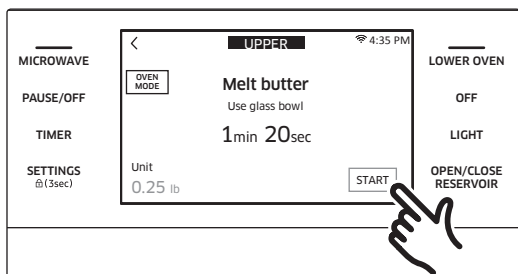
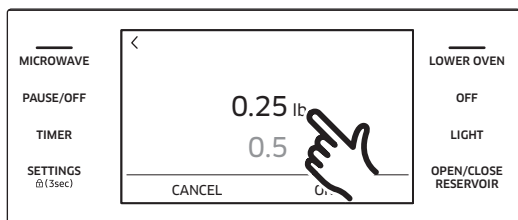
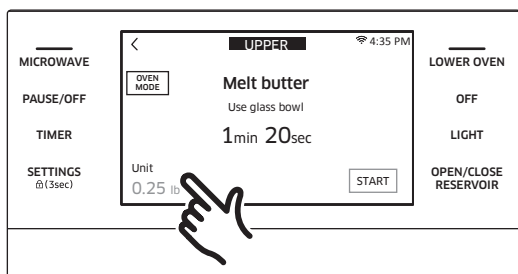
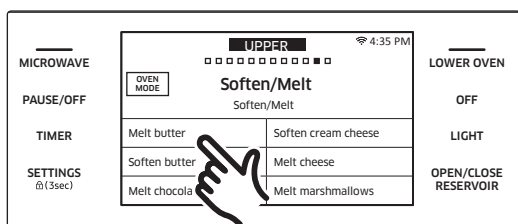
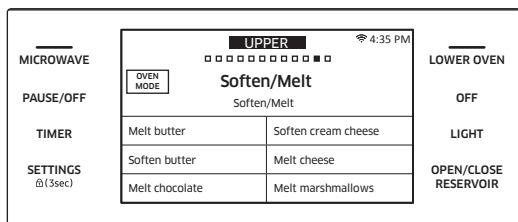

1. Put the food in the center of the optitray, and close the door.
2. Touch **MICROWAVE**, and swipe the screen to select **Sense Cook**. The display shows 8 **Soften/Melt** options.
3. Scroll-tap the desired option.

4. Tap the weight area to select the food weight screen.

5. Slide the screen to select the weight.
6. Tap **OK**.

7. Tap **START** to start cooking.

If you want to pause cooking, tap **PAUSE**. With cooking paused, tap either **OFF** to quit or **CONTINUE** to resume cooking.

Microwave oven (Upper Oven)

| Food | Amount | Instructions |
|---------------------|-----------------------------------------|--------------------------------------------------------------------------------------------------------------------------------------------------------------------------------|
| Soften/Melt | | |
| Melt butter | 0.25 lb (1 stick) 0.5 lb (2 sticks) | Unwrap, cut butter into pieces, and put in microwave-safe bowl; cover with wax paper, melt, stir well. |
| Soften butter | 0.25 lb (1 stick) 0.5 lb (2 sticks) | Unwrap butter, and put on microwave-safe dish. |
| Melt chocolate | 1 cup chips | Put chocolate chips in microwave-safe bowl; when microwave beeps, stir well, and press START to resume. (Unless stirred, chocolate chips keep their shape even after heating.) |
| Soften ice cream | 1 serving: 1 pint 2 servings: 1.5 qt | Remove lid; put carton in center of microwave. |
| Soften cream cheese | 4 oz 8 oz | Remove metallic wrapper; put cream cheese on microwave-safe dish. |
| Melt cheese | 4 oz 8 oz | Put cheese in microwave-safe bowl; cover with wax paper, melt, stir well. |
| Melt marshmallows | 5 oz 10 oz | Put in large microwave-safe , melt, stir well. |
| Melt caramel | 4 oz 8 oz | |

Oven (Lower Oven)

Timed cooking

In this mode, the oven turns on immediately and cooks for the length of time you select, then turns off automatically when done.

Timed cooking can only be used with another cooking operation (Bake, Convection Bake, Convection Roast, Broil, Pure Convection Sear, Convection Broil, Steam Bake, Steam Roast, Dual Four Part Pure Convection, Proof, Stone Bake Mode, Dehydrate).

How to set the oven for timed cooking

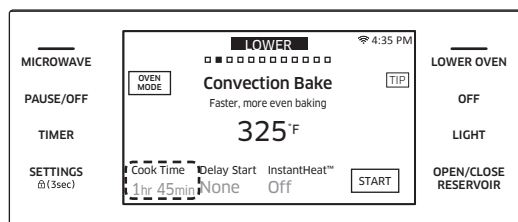
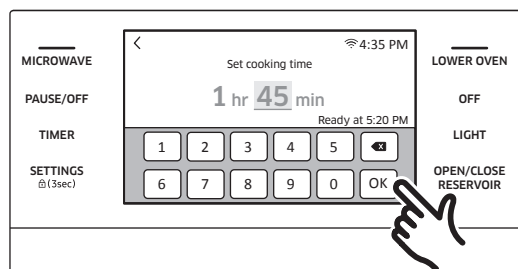

1. Tap **LOWER OVEN** and swipe the screen, and select a cooking operation.
2. Tap **Cook Time**. The display changes to the cooking time screen.
3. Tap numbers on the numeric pad to set the cook time (from 1 min to 9 hrs, 59 min).
4. Tap **OK**. The cooking time screen closes. The cooking time appears in the Cook Time area of the screen.
5. Tap **START** to start cooking. (To cancel at any time, set the Cook Time to 0 min.)

NOTE

See basic baking and broiling instructions in this manual.

Oven (Lower Oven)

CAUTION

Timed cooking and Delay Start are good for cooking cured or frozen meats and most fruits and vegetables.

Foods that spoil easily (e.g., milk, eggs, thawed/fresh fish, meat, or poultry) should be chilled in the refrigerator first. Even when chilled, however, they should not sit in the oven more than 1 hour before cooking, and should be removed promptly when done. Eating spoiled food can result in sickness from food poisoning.

Delay start

For this mode, the oven timer turns the oven on at a preset time. To have the oven turn off automatically after a set time has elapsed, set the Timed Cooking function.

- You can use Delay Start only with another cooking operation (Bake, Convection Bake, Convection Roast, Pure Convection Sear, Steam Bake, Steam Roast, Dual Four Part Pure Convection, Proof, Stone Bake Mode, Dehydrate, Self clean, GreenClean™).
- You can set the oven for a delayed start before setting other cooking operations.
- The clock must be set to the current time.

How to set the oven for delay timed cooking

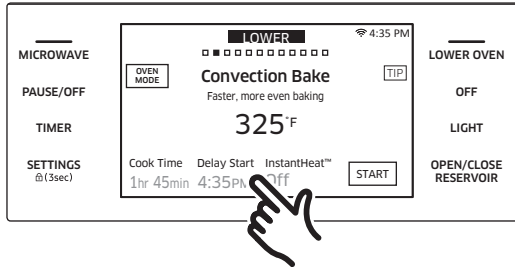

1. (With the food in the oven) Tap **LOWER OVEN**, swipe the screen, and select a cooking operation.
2. Set the cook time if you want the oven to turn off automatically when the food is done. (See **Timed cooking**, previous procedure).
3. Tap **Delay Start**. The current time appears as the first entry.
4. Tap numbers on the numeric pad to set the oven start time.

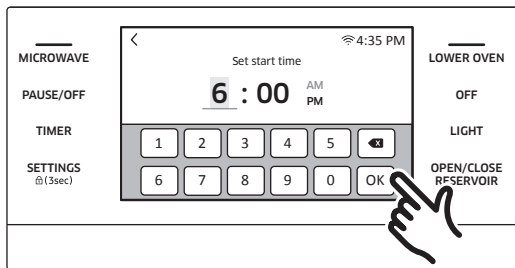

5. Tap **OK**. The Delay Start screen closes. The start time, and, if set, the cook time, appears onscreen.
6. Tap **START** to start cooking.

NOTE

See basic baking and broiling instructions in this manual.

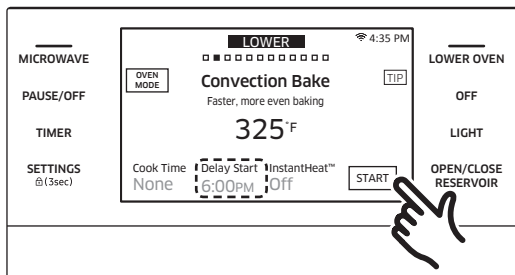

Oven (Lower Oven)

Using the temp probe

For many foods, especially roasts (e.g., beef, pork, lamb) and poultry (chicken, turkey, etc), measuring internal temperature is the best way to determine doneness. The temp probe lets you cook meat to the exact desired internal temperature. This function can be used with Bake, Convection Bake, or Convection Roast. The food's internal temperature appears on the oven display from 100 °F upward.

How to use the temp probe

1. Push the Temp probe fully into the center of the meat, not touching bone, fat, or gristle.

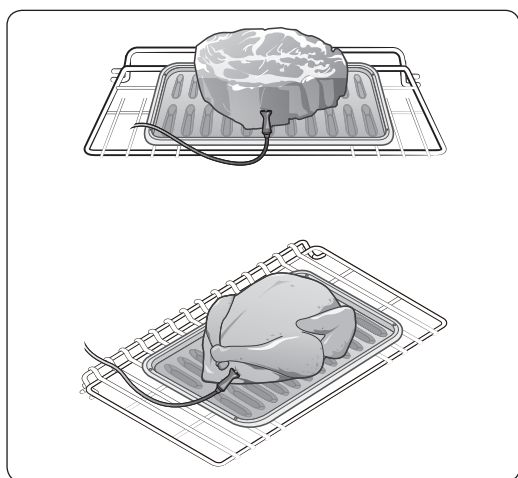

- Insert the probe fully into the meat as shown without touching bone, fat, or gristle.
- If not fully inserted, the Temp Probe will sense the oven temperature, not the meat temperature.
- For bone-in meat, center the probe in the lowest, thickest part of the piece.
- For whole poultry (turkey, large chickens, etc.), insert the probe in the thickest part of the inner thigh, parallel to the leg.
- If you activate **Keep Warm** to keep the meat warm after using **Temp Probe**, the meat's internal temperature will exceed the desired temperature.

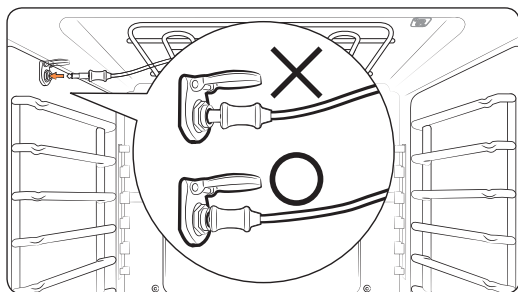

2. Insert the temp probe plug fully into the socket on the oven's top side wall .
3. Tap **LOWER OVEN**, and swipe the screen to select a cook mode (Bake, Convection Bake, Convection Roast, Pure Conv.Sear, or 4 Part Pure Convection).
4. Tap **Temp Probe** , then use the number pad to set the desired internal temperature.

| | |
|------------------------|------------------|
| Available temperatures | 100 °F to 200 °F |
|------------------------|------------------|

5. If you want to use the Cook time or Delay start, set each function, and tap **START**.
6. When the desired internal temperature is reached, the temp sensor shuts off, and an alarm sounds.

 **CAUTION**

To protect the Temp probe tip, it should not protrude through the surface of the meat but should be in or near the center.

- Do not store the probe in the oven or leave it in the oven after cooking; always remove the probe after use to avoid damaging it later.
- To avoid breaking the probe's tip, defrost your food completely.
- Do not use tongs to insert/remove the probe. Tongs can damage the probe.
- Use the Temp probe for Temp Probe function cooking only.

 **NOTE**

- If you remove the probe while the Temp Probe function is active or insert the probe during normal baking/cooking, cooking will stop after 1 minute.
- If you use the probe to cook frozen food, the probe may not be detected by the oven, thus, the probe icon will not appear onscreen.)

Temp probe table

| Type of Food | | Internal temperature |
|--------------|-----------|----------------------|
| Beef / Lamb | Rare | 140 °F |
| | Medium | 160 °F |
| | Well done | 170 °F |
| Pork | | 170 °F |
| Poultry | | 180-185 °F |

 **NOTE**

If you cover the meat with aluminum foil and allow it to stand for 10 minutes after cooking, the Internal temperature will rise 5-10 degrees.

Removing the temp probe

Remove the temp probe plug from the socket.

 **CAUTION**

After cooking, the Temp probe is hot enough to cause burns. Let it cool sufficiently before attempting to remove it.

Oven functions

Cooking mode

Tap LOWER OVEN and swipe to select the cooking mode. See Basic baking and broiling instructions starting, **pg. 61**.

| Mode | Temperature range | Lower | Temp probe | InstantHeat™ |
|--------------------------------|-----------------------------------|-------|------------|--------------|
| Bake | 175 °F (80 °C) - 550 °F (285 °C) | ✓ | ✓ | - |
| Convection Bake | 175 °F (80 °C) - 550 °F (285 °C) | ✓ | ✓ | ✓ |
| Convection Roast | 175 °F (80 °C) - 550 °F (285 °C) | ✓ | ✓ | ✓ |
| Broil | LO / HI | ✓ | - | - |
| Pure Conv. Sear | 175 °F (80 °C) - 475 °F (245 °C) | ✓ | ✓ | - |
| Convection Broil | 175 °F (80 °C) - 550 °F (285 °C) | ✓ | - | - |
| Steam Bake | 230 °F (110 °C) - 550 °F (285 °C) | ✓ | ✓ | - |
| Steam Roast | 230 °F (110 °C) - 550 °F (285 °C) | ✓ | ✓ | - |
| Dual Four Part Pure Convection | 175 °F (80 °C) - 550 °F (285 °C) | ✓ | ✓ | - |

| Mode | Description |
|------------------|----------------------------------------------------------------------------------------------------------------------------------------------------------------------------------------------------------------------------------------------------------------------------------------------------------------------------------------------------------------------------------------------------------------------------------------------------------------------|
| Bake | <ul style="list-style-type: none"> • For cooking cakes, cookies, casseroles; always preheat the oven. • Baking temperatures and times vary with ingredients. and the size and shape of the pan. • Dark or nonstick coatings may cook faster with more browning. <p> NOTE The convection fan normally cycles on/off during baking.</p> |
| Convection Bake | <ul style="list-style-type: none"> • A fan circulates heat evenly and continually within the oven. • Improved heat distribution allows even cooking and excellent results, even while using multiple racks. • Breads and pastries brown more evenly. |
| Convection Roast | <ul style="list-style-type: none"> • For cooking large, tender cuts of meat, uncovered; the fan circulates heated air evenly over and around food. • Meat/poultry brown all over as if rotisserie-cooked. • Heated air traps juices quickly for moistness/tenderness while creating a golden-brown exterior. |

Oven (Lower Oven)

| Mode | Description |
|--------------------------------|----------------------------------------------------------------------------------------------------------------------------------------------------------------------------------------------------------------------------------------------------------------------------------------------------------------------------------------------------------------------------------------------------|
| Broil | <ul style="list-style-type: none"> • For cooking tender cuts of meat directly, under the broil element. • The high heat cooks quickly and creates a rich, brown exterior. • Best for meat, fish, and poultry up to 1 inch thick. • Always preheat the oven for 5 minutes. • See Broiling recommendation guide (pg. 60). |
| Pure Conv. Sear | <p>Uses the convection element and fan; meat is cooked 75 °F (42 °C) higher than the set temperature for the first 15 min.; the resulting browning process sears the exterior to trap natural juices; best for game hens, chickens, stuffed/un-stuffed turkeys, turkey breasts, pork tenderloin, and pork loin.</p> |
| Convection Broil | <ul style="list-style-type: none"> • Similar to Broil but has the benefit of fan-circulated air; the broil element cycles on/off to maintain oven temperature, while the fan circulates the hot air. • For thicker cuts of meat, fish, and poultry; gently browns the exterior, trapping the juices. • Always preheat the broil element for 5 minutes. |
| Steam Bake | <p>Excellent for breads, pastries, and desserts; increases moisture content and improves texture and flavor. See Steam cook recommendation guide (pg. 60).</p> |
| Steam Roast | <ul style="list-style-type: none"> • Excellent for roasted meats or poultry; maintains a crispy surface while trapping juices for a moist, tender result. • See Steam cook recommendation guide (pg. 60). |
| Dual Four Part Pure Convection | <p>Uses the convection element and fan; uniform air circulation lets you optimize oven space; use for single-rack baking, multi-rack baking, roasting, and preparing whole meals; many foods (e.g., pizza, cake, cookies, biscuits, muffins, rolls, frozen convenience foods) can be prepared on 2 or 3 racks at once; also good for whole roasted duck, lamb shoulder, and short leg of lamb.</p> |

Oven (Lower Oven)

Broiling recommendation guide

Size, weight, thickness, starting temperature, and doneness preference affect broiling times. This guide is based on meats at refrigerator temperature. Always use a broiler pan and its grill when broiling, and preheat the oven for 5 minutes.

| Food | Doneness | Size | Thickness | Level | Rack position | Cooking time (min.) | |
|----------------|-----------|-----------|-----------|-------|---------------|---------------------|-------------|
| | | | | | | 1st side | 2nd side |
| Hamburgers | Medium | 9 patties | 3/4" | Hi | 6 | 3:00 | 2:00 |
| | Medium | 9 patties | 1" | Hi | 6 | 3:20 | 2:20 |
| Beef steaks | Rare | - | 1" | Hi | 5 | 5:00 | 4:00 |
| | Medium | - | 1-1 1/2" | Hi | 5 | 6:00-6:30 | 4:30-4:00 |
| | Well done | - | 1-1 1/2" | Lo | 4 | 7:00-8:00 | 4:00-5:00 |
| Chicken pieces | Well done | 4.5 lbs | 1/2-3/4" | Lo | 3 | 16:00-18:00 | 13:00-15:00 |
| | Well done | 2 lbs | 1/2-3/4" | Lo | 3 or 4 | 15:00-16:00 | 10:00-12:00 |
| Pork chops | Well done | 1 lbs | 1" | Lo | 3 | 8:00-10:00 | 6:00-8:00 |
| Fish fillets | Well done | - | 1/4-1/2" | Lo | 3 or 4 | 7:00-8:00 | 4:00-5:00 |

Steam cook recommendation guide

| Steam mode | Level | Foods |
|-------------|-------|-----------------------------------------------|
| Steam bake | High | Rye breads, Desserts (Flan caramel) |
| | Med | Croissants, Pies, Reheats (Pizza, Casseroles) |
| | Low | Pastries |
| Steam Roast | High | - |
| | Med | Meats, Poultry |
| | Low | Turkey, Large meats |

Basic baking and broiling instructions

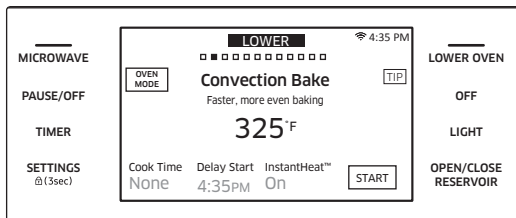
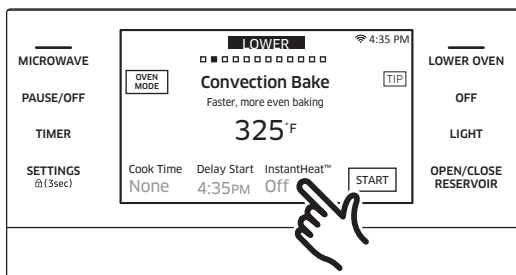
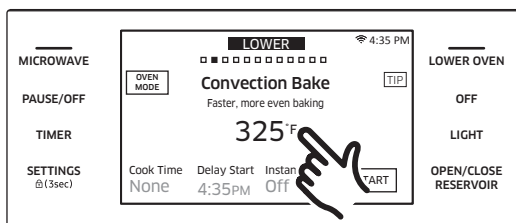
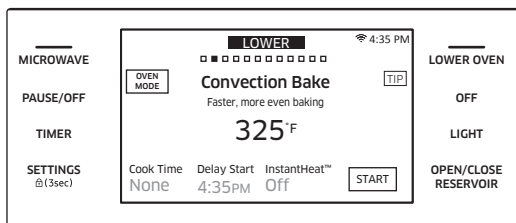

1. Tap **LOWER OVEN** and swipe the screen to select the desired cooking mode.
2. Set the temperature you want. (See the **Cooking mode** on page 89.)
 - Broil mode can be set only Hi or Low.
 - Keep Warm and Bread Proof temperatures are fixed and cannot be changed.
3. Follow the steps below to use the Instant Heat™ feature, Steam Bake, or Steam Roast. If you are not using these features, skip these steps and go to Step 5 on the next page.
 - Instant Heat™
 - a. If you select Convection Bake or Convection Roast, the display will show the **Instant Heat™** information. (The default is OFF).
 - b. Tap the Instant Heat™ area. The Instant Heat™ feature is activated and the display will show ON.

NOTE

- For best performance, we recommend cooking on a single rack.

| Type | Rack Positions |
|----------|----------------|
| Baking | 3 or 4 |
| Roasting | 1 or 2 |

- Place food in the oven before you start cooking when using the InstantHeat™ feature.
- For best performance, preheat the oven when baking rising bakery products such as angel food cakes, bundt cakes, or puff pastries.

Oven (Lower Oven)



- Steam Bake, Steam Roast
Important: Fill the water reservoir before starting steam cooking. (See **Water reservoir**, pg. 18).
 - a. If you selected Steam Bake or Steam Roast, the display shows the steam level information. (default: Medium).
 - b. Tap the Steam area to adjust the steam level. The steam level adjustment screen appears. Set the steam level to Low, Medium, or High.
 - c. Tap **OK**. The steam level adjustment screen closes and the steam level information is displayed.
- 4. If you want to use the **Cook Time**, or **Delay Start** function, set each function now. See pages 53 and 55 respectively, for instructions.
- 5. Tap **START** to begin cooking.
- 6. Tap **OFF** when cooking is done or if you want to cancel cooking.

How to adjust the temperature while cooking

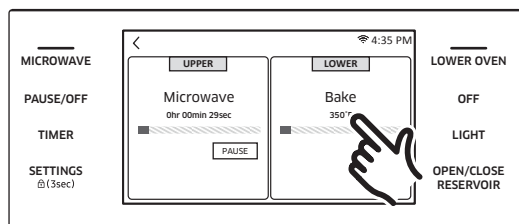

To adjust the temperature in the lower oven

- Tap **LOWER** area on the screen, tap the temperature area, enter the new temperature using the numeric keypad, and then tap **OK**.



To adjust the temperature in the upper microwave oven

- Tap **MICROWAVE** on the screen, tap the temperature area, enter the new temperature using the numeric keypad, and then tap **OK**.

- ★ Put food in the oven after preheating. Preheating is very important for good results when baking cakes, cookies, pastry, and breads. When the oven reaches the set temperature, the oven beeps 6 times.
- The convection oven fan shuts off when the oven door is opened.
- DO NOT leave the door open for long periods of time while using convection cooking or you may shorten the life of the convection heating element.

NOTE

- If the door is left open over 2 min. when the oven is on, the oven shuts off automatically.
- When done cooking, the cooling fan runs until the oven cools down.
- Drain residual water after steam cooking. Do not interrupt the draining cycle.
- After a steam cycle, empty the reservoir of residual water.
- Oven-chamber thermometer readings may differ from the oven temp setting.
- The convection fan cycles on/off while the oven is cooking.
- Keep the oven door closed while broiling.

Using the special function feature

Special function provides 4 different specialized cooking options.

| Mode | Temperature range | Lower |
|-----------------|----------------------------------|-------|
| Keep Warm | **None | ✓ |
| Proof | 95 °F (35 °C) / 105 °F (40 °C) | ✓ |
| Stone Bake Mode | 175 °F (80 °C) - 550 °F (285 °C) | ✓ |
| Dehydrate | 105 °F (40 °C) - 225 °F (105 °C) | ✓ |

** A factory-set, non-adjustable temperature is applied for best performance.

Oven (Lower Oven)

| Mode | Description |
|-----------------|-------------------------------------------------------------------------------------------------------------------------------------------------------------------------------------------------------------------------------------------------------------------------------------------------------------------------------------------------------------------------------------------------------------------------|
| Keep Warm | <ul style="list-style-type: none"> Keeps cooked food warm for serving up to 3 hr after cooking is done. Use this mode by itself or set it to activate after timed or delay-timed cooking. You should not use this mode to reheat cold food. |
| Proof | <ul style="list-style-type: none"> Provides optimal temp (100 °F / 110 °F) for bread proofing. For the best results, always start Proof with a cool oven. |
| Stone Bake Mode | <ul style="list-style-type: none"> Bake on a baking or pizza stone (not included) for pizza and bread. Always preheat with a stone for the best results. |
| Dehydrate | <ul style="list-style-type: none"> Removes moisture from food via heat circulation. Keep dehydrated food in a cool, dry place. For fruit, add lemon or pineapple juice, or sprinkle sugar to preserve sweetness. This table provides Dehydrate settings: Vegetables and fruit on rack level 3 or 4 at 105 –150 °F Meat on rack level 3 or 4 at 145 – 225 °F |

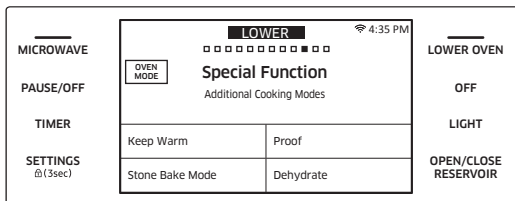

1. Tap **LOWER OVEN**, and swipe the screen to **Special Function**. Specific cooking options appear.

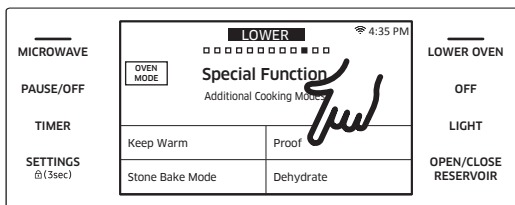

2. Tap an option.

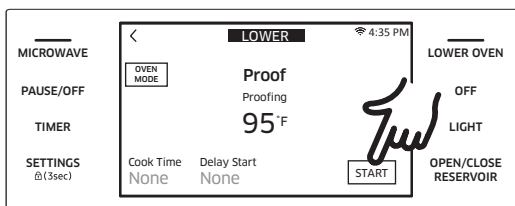

3. Set a temperature, and tap **START**.

NOTE

Keep Warm mode temperatures are not adjustable.

CAUTION

- If the oven temperature is above 125 °F, Proof mode will not function properly.
- Do not use Proof to warm food. (Proof temp is not hot enough to keep food warm.)
- Put dough in a heat-safe bowl (rack level 3 or 4), and cover with a cloth or plastic wrap.
- To avoid lowering the temp and prolonging proofing, leave the oven door closed.

NOTE

- Preheating is unnecessary for all Special Function options but Stone Bake mode.
- An beep alerts you if the temperature setting is out of the set range.

Oven (Lower Oven)

Rack position chart for special cooking options

| Mode | Rack position |
|-----------------|---------------|
| Keep Warm | 5 |
| Proof | 3 |
| Stone Bake Mode | 1 or 2 |
| Dehydrate | 3 or 4 |

Using Chef mode

For inexperienced cooks, the oven offers 15 gourmet auto-cook options. Use this feature to save time or shorten your learning curve.

The cook time and temperature are automatically adjusted to the selected recipe. You can download detailed recipes for each option from the Dacor website.

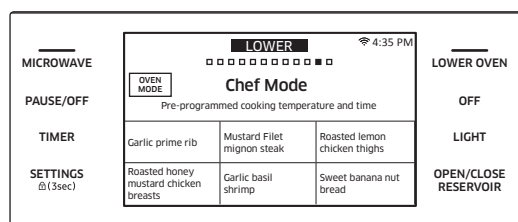

1. Tap **LOWER OVEN**, and swipe the screen to Chef Mode. The display shows 15 auto-cook options. (Scroll to select an option.)

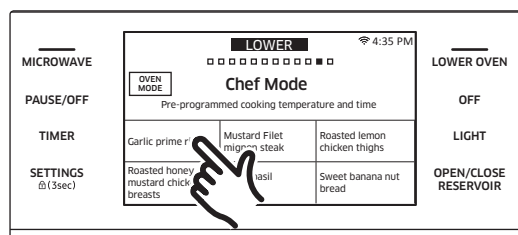

2. Tap a Chef Mode option.

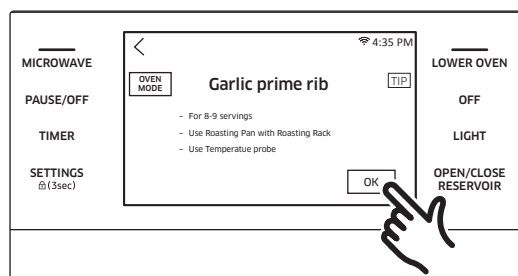

3. Follow the on-screen instructions.



4. Tap **START** to start cooking.

Cooking tips in chef mode

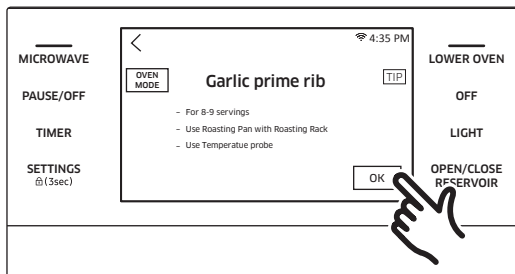

1. Tap **OK**.

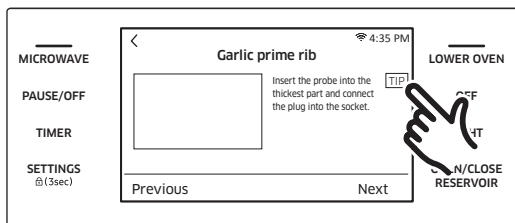

2. Tap **TIP**.

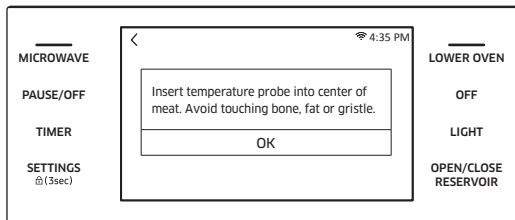

3. The display will show the cooking tip. You can view the tip before or during cooking.

Oven (Lower Oven)

Using the iQ control feature (Lower oven only)

To use the iQ Control feature, download the Dacor iQ Kitchen app to a mobile device. Functions that can be operated by the Dacor iQ Kitchen app may not work smoothly if communication conditions are poor or the oven is in a place with a weak Wi-Fi signal. See this table for the main functions that can be operated from the app:

| | |
|-------------------------------------|------------------------------------------------------------------------------------------|
| When iQ Control on the oven is off. | Monitoring (Microwave, Lower Oven, Probe), Lower Oven off |
| When iQ Control on the oven is on. | Monitoring (Microwave, Lower Oven, Probe), Lower Oven start, Lower Oven off, Error check |

How to connect the oven

1. Download and open the Dacor iQ Kitchen app on your smart device.
2. Follow the app's on-screen instructions to connect your oven.
3. Once the process is complete, the connected icon (📶) on your oven appears; the app confirms the connection.
4. If the icon does not appear, follow the app's directions to reconnect.

To start the oven remotely

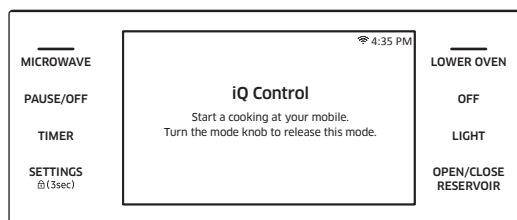

Tap **SETTINGS** > **iQ Control**, and then tap **ON** or **LOWER OVEN**. The oven can now be started and controlled remotely by a connected mobile device.

When iQ Control is on you can:

- Remotely change oven settings (mode, time, temperature) with your mobile device.
- Remotely start/turn off the oven.
- Once cooking starts, you can change the cooking time and temperature remotely.

NOTE

Self Clean mode cannot be started remotely.

- Opening the oven door deactivates iQ Control and keeps you from turning the oven on or controlling it remotely.
- If iQ Control is inactive, you can still monitor oven status and turn the oven off.
- When oven cooking is finished or cancelled, iQ Control will be deactivated.

Oven (Lower Oven)

Using the oven racks

Lower oven rack positions

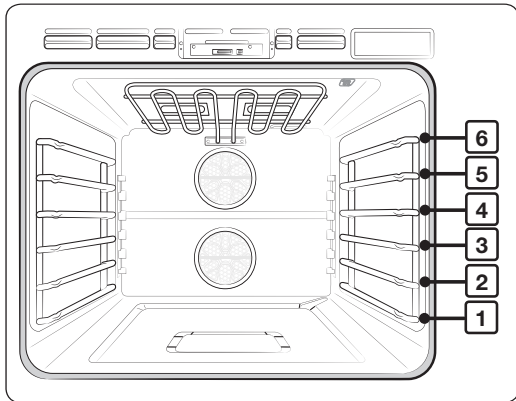

Recommended rack positions for cooking

| Type of Food | Rack Positions |
|---------------------------------------------------|----------------|
| Broiling hamburgers | 6 |
| Broiling meats or small cuts of poultry, fish | 3-5 |
| Bundt cakes, pound cakes, frozen pies, casseroles | 4 or 3 |
| Angel food cakes, small roasts | 2 |
| Turkeys, large roasts, hams, fresh pizza | 1 |

- This table is for reference only.

Rack and pan placement

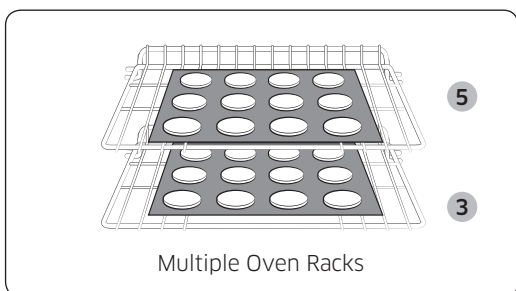
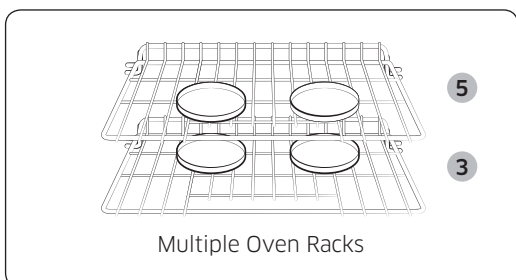
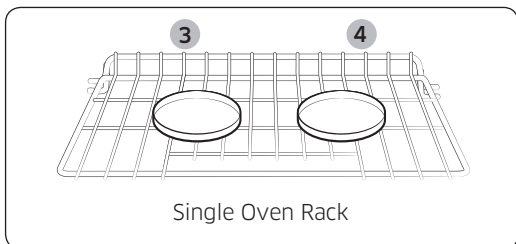

Centering baking pans in the oven as much as possible improves results. If baking with multiple pans, arrange the pans with 1" to 1 1/2" of space all around.

When baking on one oven rack, place the oven rack at level 3 or 4. (See left.)

For multi-rack baking of cake or cookies, place the racks at levels 3 and 5.

| Type of Baking | Rack Positions |
|-------------------|----------------|
| Cakes and cookies | 3 and 5 |

Oven (Lower Oven)

Before using the racks

Each rack has stops that must be placed correctly on the supports. These stops keep the rack from coming completely out.

Removing the racks

1. Pull the rack straight out until it stops.
2. Lift up the front of the rack, and then pull it out.

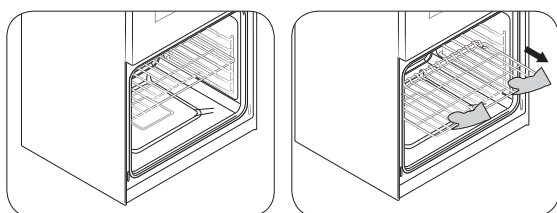

Replacing the racks

1. Place the end of the rack on the support.
2. Tilt the front end up and push the rack in.

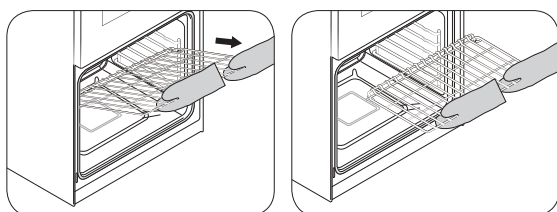

⚠ CAUTION

- Do not cover any rack or oven surface with foil. Doing so hampers heat circulation, resulting in poor baking, and possibly oven damage.
- Arrange the racks when the oven is cool.

Using the gliding rack

The fully extendable gliding rack makes food preparation easier, especially in handling large, heavy dishes. Gliding tracks let the rack extend well out of the oven.

Installing the gliding rack

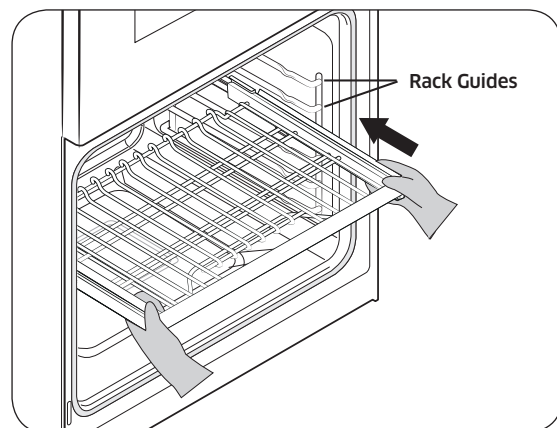

- With the gliding rack rails retracted and the oven off, carefully insert the rack between the guides, and slide it fully into the oven chamber.

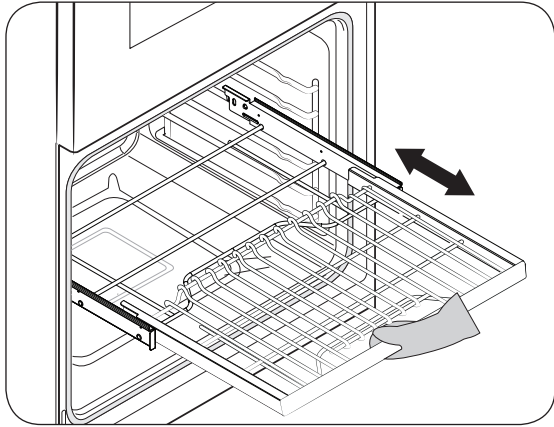

- When sliding the gliding rack in/out, use the rack's front handle. If you grasp by the frame, you will pull the rack out of the oven. Use oven mitts to handle the gliding rack while cooking.

Removing the gliding rack

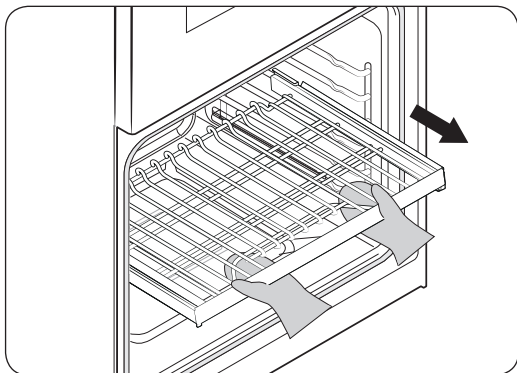

- With the oven off and cool, open the door, and grasp the rack and frame, and pull both forward to remove.

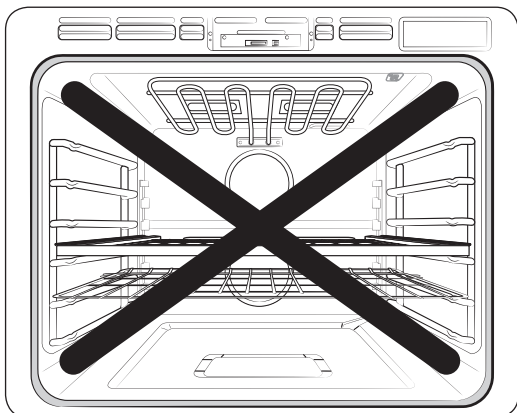

CAUTION

Do not install the Gliding rack on the next level above a wire rack. It will not engage properly and may fall.

NOTE

You can install the Gliding rack on any level except the lowest (Level 1).

Oven (Lower Oven)

Using the clean feature

The Clean feature has four selections: Self-Clean, GreenClean™, Descal, and Draining.

Self clean

This self-cleaning oven uses high temperatures (well above cooking temperatures) to burn off or reduce cooking residue to a fine ash you can wipe away with a damp cloth.

⚠ CAUTION

- During self-cleaning, the outside of the oven becomes hot enough to burn skin. Do not let children near the oven during self-cleaning.
- Some birds are extremely sensitive to the fumes emitted during self-cleaning. Move birds to another, well-ventilated room.
- The oven door locks during self-cleaning. Do not force the door open.
- Use care when opening the oven door after self-cleaning. Stand to one side when opening the door to let hot air or steam escape safely.

Before a self-cleaning cycle

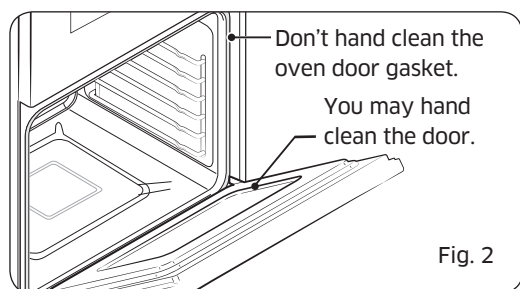
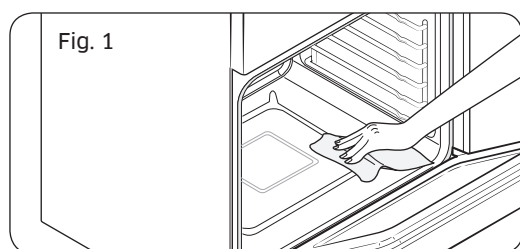

- You should open a window or use a fan or hood to ventilate the kitchen during self-cleaning.
- Remove all accessories from the oven chamber.
- Wipe residue from the oven floor (Fig. 1).
- The silver-colored oven racks can be self-cleaned, but they will lose their luster and become hard to slide.
- Clean the front frame of the oven and outside the door gasket with hot water, soap-filled steel-wool pads, or mild cleansers. Rinse and dry.
- Do not clean the door gasket. Its material cannot withstand abrasion. The gasket must remain intact to function properly. If it becomes worn or frayed, have it replaced. (Fig. 2)
- Make sure the oven light cover is in place and the oven light is off.

How to run a self-cleaning cycle

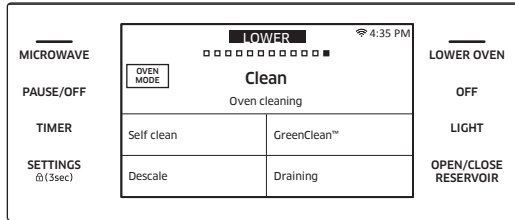

1. Tap **LOWER OVEN** and swipe the screen to **Clean**. The display will show 4 cleaning selections.

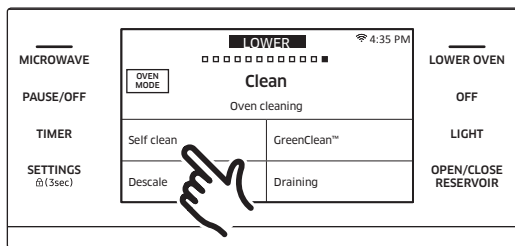

2. Tap **Self Clean**.

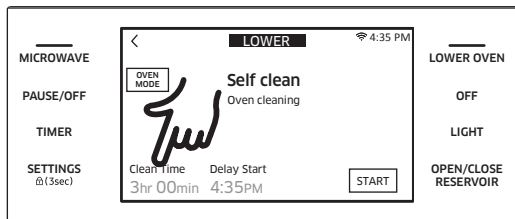

3. Tap **Clean Time**.

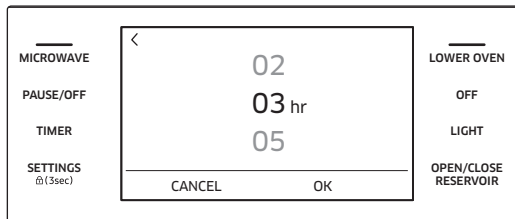

4. Slide the screen to set the clean time. You can choose 2 hours, 3 hours, or 5 hours. (The default is 3h).
5. Tap **OK**.

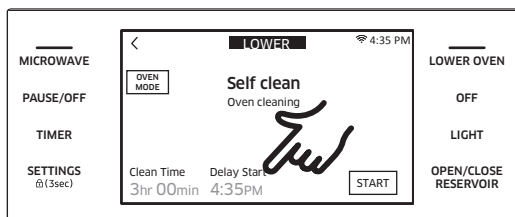

6. If you do not want to use the Delay Start feature, go to Step 8. Otherwise, tap **Delay Start**, and then go to Step 7.

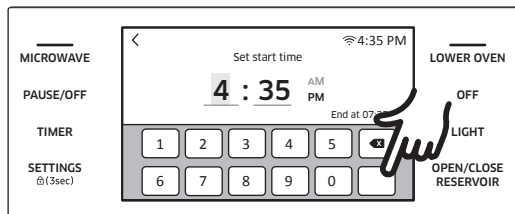

7. Set the time you want self-cleaning to start, and then tap **OK**.

Oven (Lower Oven)

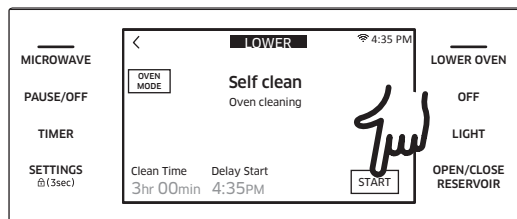

8. Tap **START** to begin self-cleaning. The door locks automatically. Important: Only the lower oven door locks during self cleaning.

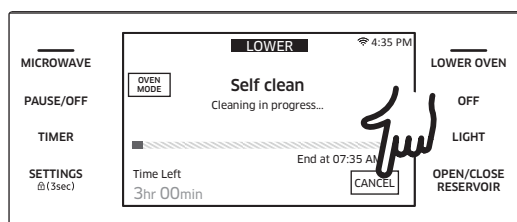

9. Tap **CANCEL** to pause or end a self-cleaning cycle.

NOTE

- Self-cleaning cannot begin if the control lockout feature is active or the oven is too hot.
- The oven doors lock automatically. The display counts down the cleaning time. You cannot open the oven doors until the temperature drops to a safe temperature.
- The self-clean feature can be used in only one oven at a time. While one oven is in self-cleaning mode, the other oven will not operate.

After a self-cleaning cycle

- Wipe up any ash with a damp cloth after the oven cools. (Remove any white spots with a soap-filled, steel-wool pad and rinse well with a vinegar-water mixture.)
- If the oven is not clean after one cycle, repeat the cycle.
- You cannot set the oven for cooking until the door unlocks.

GreenClean™

This function saves time and energy by removing residue that you can wipe away with a damp cloth.

CAUTION

- The oven door locks during Green cleaning. Do not force the door open or you may damage the locking system. Open the oven door carefully after Green cleaning. Stand to one side when opening the door so hot air or steam escape safely.

Oven (Lower Oven)

Before a green cleaning cycle

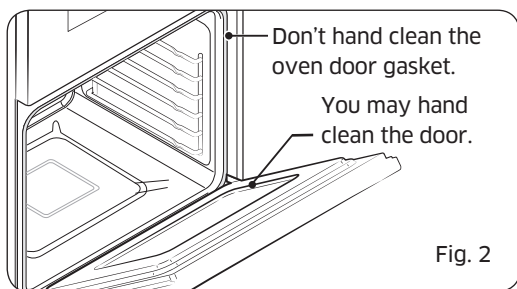
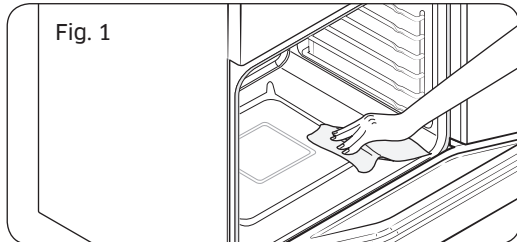

- Open a window, or use a fan or hood to ventilate the kitchen during self-cleaning.
- Remove all accessories from the oven chamber.
- Wipe residue from the oven floor (Fig. 1).
- The silver-colored oven racks can be self-cleaned, but they will lose their luster and become hard to slide.
- Hand-clean the front frame of the oven and outside the door gasket. Clean these areas with hot water, soap-filled steel-wool pads, or mild cleansers. Rinse with clean water, and dry.

- Do not clean the door gasket (Fig. 2). Its material is easily damaged. The gasket must remain intact to function properly. If it becomes worn or frayed, have it replaced.
- Make sure the oven light cover is in place and the oven light is off.
- Green cleaning can be used in only the lower oven. The microwave does not operate during Green cleaning.
- Rub detergent into heavy soil before Green cleaning.
- You cannot start Green cleaning if Control Lockout is active or if the oven is too hot.

How to run a green-cleaning cycle

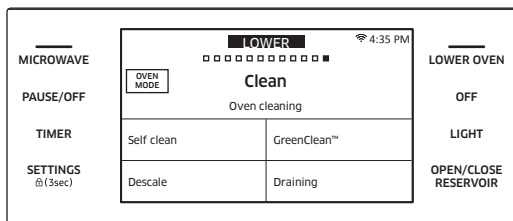

1. Tap **LOWER OVEN** and swipe the screen to **Clean**. The display will show 4 cleaning selections.

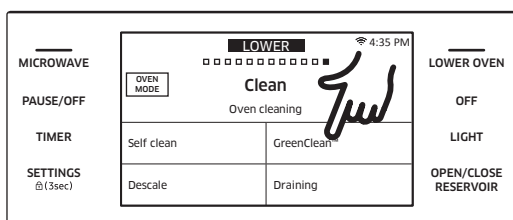

2. Tap **GreenClean™**.

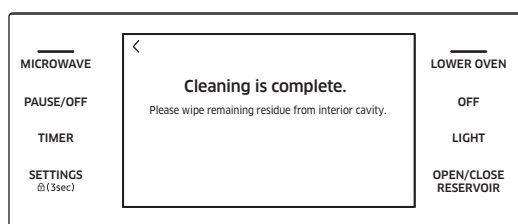
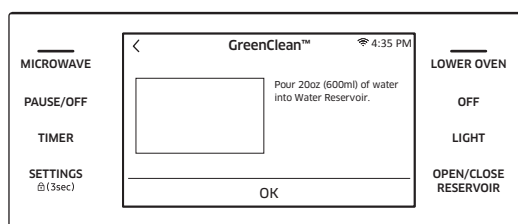
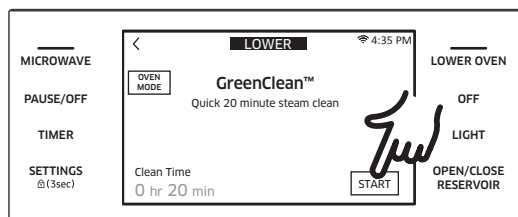

3. Tap **START** to begin Green cleaning.

4. Follow the on-screen instructions. Green cleaning will start automatically.

NOTE

Lower oven door is locked during Green cleaning.

5. When Green cleaning is done, clean the oven chamber. Considerable water will be pooled on the oven floor. Remove the water with a sponge or soft dry cloth.

NOTE

For Green cleaning, exactly 10 oz (300 ml) of water produces the best results.

After a green cleaning cycle

- Open the door carefully after Green cleaning. The water in the oven is hot.
- Wipe the oven chamber and below the door seal, and dry with a soft cloth.
- Wipe the oven chamber with a soapy sponge, or soft brush or scrubber. Remove tough residue with a nylon scourer. Remove lime deposits with a vinegar-soaked cloth.
- If the oven remains dirty, repeat the procedure when the oven cools.
- After cleaning, leave the door ajar so the interior enamel surface can dry thoroughly.
- You cannot set the oven to cook until the oven door unlocks.

Oven (Lower Oven)

Descal

If you use Steam Bake or Steam Roast frequently, you should descale regularly to remove minerals that may affect the taste or quality of food cooked. Use only descaling agents designed for steam ovens or coffee machines.

NOTE

After 12 accumulated hours of steam baking/roasting, the Descal indicator appears. You can enable these two functions for two more hours without descaling. When those two hours are up, Steam Bake or Steam Roast are disabled until you run a descaling cycle.

How to run a descale cycle

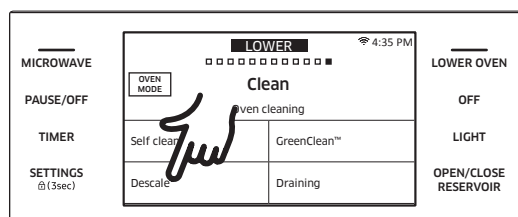

1. Tap **LOWER OVEN** and swipe the screen to **Clean**. The display will show 4 cleaning selections.
2. Tap **Descal**.

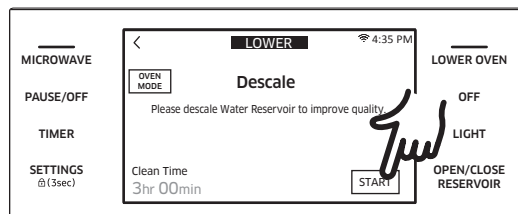

3. Tap **START**.

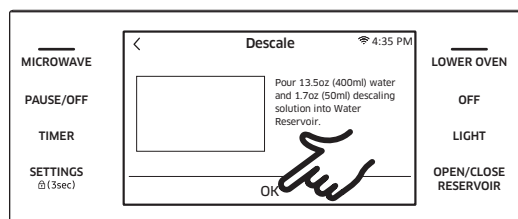

4. Follow the on-screen instructions. It takes 3 hours to complete the cycle.
 - Empty and clean the water reservoir, and then fill it with 1.7 oz (50 ml) of descaling agent and 13.5 oz (400 ml) of drinkable water.

Oven (Lower Oven)

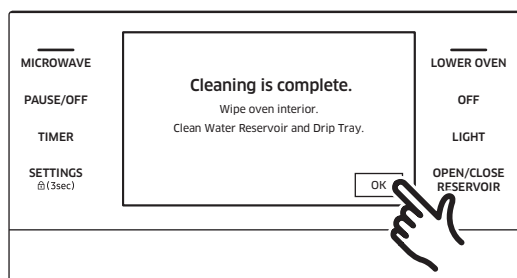
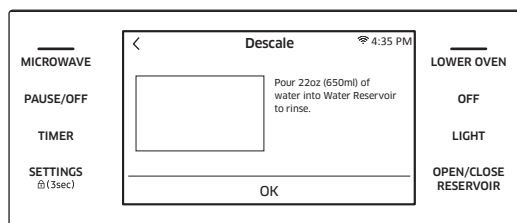
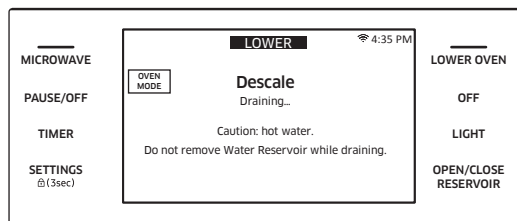

5. When descaling is complete, the oven drains water automatically.
6. Use oven mitts to remove and empty the water reservoir, and then refill it with 22 oz (650 ml) of drinkable water for rinsing.
7. Follow the on-screen instructions, and then tap **OK** to start rinsing.
8. When rinsing is complete, use oven mitts to empty and clean the water reservoir.

WARNING

Use only descaling agents that are specific to steam ovens or coffee machines.

CAUTION

- Running descaling disables Steam Bake and Steam Roast. Do not cancel a descaling cycle. If stopped, it must be restarted and completed within three hours to re-enable Steam Bake and Steam Roast.
- To avoid accidents, keep children away from the oven.
- For the correct ratio of water to descaling agent, follow the agent manufacturer's instructions. If the ratio of water to descaling agent differs from the instructions here (8:1), use the descaling agent ratio.

NOTE

Though the oven automatically starts descaling in 5 seconds without confirmation, you should confirm your selection to prevent descaling from starting by mistake.

Draining

When a steam function is complete, you must drain the remaining water to prevent the water from affecting other cooking modes.

To drain the water, follow these steps:

How to drain the oven

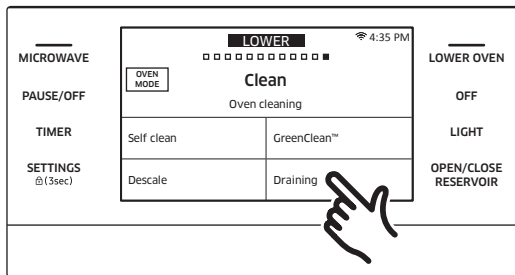

1. Tap **LOWER OVEN** and swipe the screen to Clean. The display will show 4 cleaning selections.
2. Tap **Draining**.

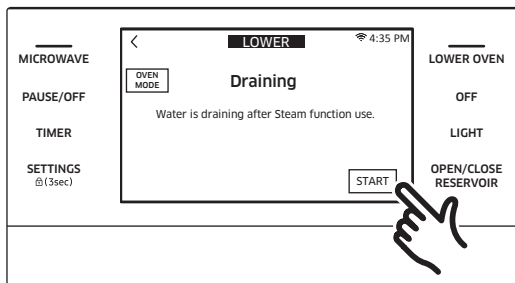

3. Tap **START**. The oven drains water from the steam generator to the water reservoir.

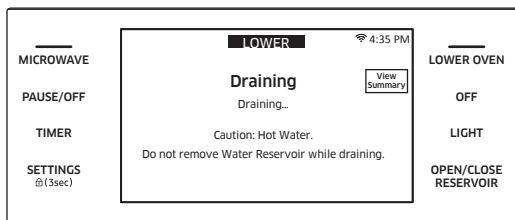

4. When draining is complete, use oven mitts to remove and empty the water reservoir.



NOTE

Once the oven starts draining, wait until the draining cycle is complete.

Oven (Lower Oven)

Settings

In Settings, you can change the default settings to your preference or diagnose problems with the network connection.

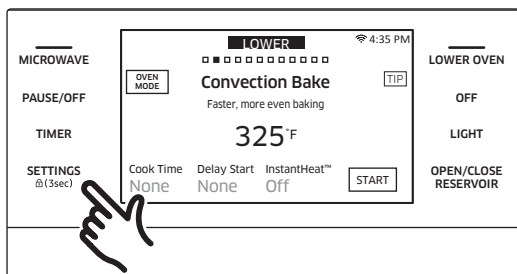

Touch **SETTINGS**. The display will show the Setting item.

Wi-Fi

To enable a Wi-Fi connection

1. Touch **SETTINGS** and then tap **Connections > Wi-Fi > ON**.
2. Tap **Wi-Fi**, and then tap a Wi-Fi network in the list that appears.
3. You will be prompted to provide a password for a secure network. Enter the password.

To manually input an IP

1. Touch **SETTINGS** and then tap **Wi-Fi > ON**.
2. Tap **Wi-Fi**, and then tap **Add Network**.
3. Enter an IP manually, and then tap **CONNECT** to apply your settings.

NOTE

- To disable a Wi-Fi connection, Touch **SETTINGS** and then tap **Wi-Fi > OFF**.
- For details about the Wi-Fi connection and using the Dacor iQ Kitchen app, see the Dacor iQ Kitchen app user manual.

iQ control

To start the oven remotely.

- Tap **SETTINGS > Connections > iQ Control**, and then tap **ON** of the **LOWER** oven. (See **Using the iQ control feature**, pg. 67.)

Easy connection

Easy connection enables you to easily configure the network settings including the authentication procedure.

Remote Management

The call center will access your product remotely to check internal when you have some problems.

Display

1. **Brightness** (changes the brightness of the display screen)
Tap **SETTINGS** > **Display** > **Brightness**. (Use the bar to adjust screen brightness.)
2. **Screen saver** (if screen saver is off, Clock theme and Timeout menu are disabled)
Tap **SETTINGS** > **Display** > **Screen saver** > **OFF**.
3. **Clock theme**
Tap **SETTINGS** > **Display** > **Clock theme**. (Slide the current setting to select a theme.)
4. **Timeout**
Tap **SETTINGS** > **Display** > **Timeout**. (Tap the current setting to select a time; you can select a time from 5 minutes to 60 minutes.)

Date & Time

To enable automatic date/time:

1. Turn on the Wi-Fi connection.
2. Tap **SETTINGS** > **Date & Time**.
3. Tap **ON** in the right screen. The date and time are set automatically.

To manually input date/time:

1. Tap **SETTINGS** > **Date & Time**.
2. Tap **OFF** in the right screen. Time zone, set date, and set time activate.
You can set the time zone, date, and time.

To change the time format:

1. Tap **SETTINGS** > **Date & Time**.
2. Tap the current setting to select a time format (12- or 24-hr clock).

Language

Choose a display language.

1. Touch **SETTINGS** and then tap **Language**. Tap the current setting to select a desired language.
2. You can select English, Spanish, or French.

Volume

Adjust the volume level for beeps and melodies.

- Touch **SETTINGS** and scroll until **Volume** menu. Use the bar to adjust the volume.

Oven (Lower Oven)

Temp

1. Temp unit:
Program the temperature display in Fahrenheit (default) or Celsius.
 - Tap **SETTINGS** > **Temp** > **Temp unit**. Tap the current setting to select the temp unit.
2. Temp adjust:
Oven temp is factory-calibrated. When first using the oven, follow recipe times and temps. If the oven seems to cook too hot or cool, you can recalibrate the cooking temps. First, test a recipe with a temp that is higher or lower than recommended. The results should help you decide the degree of adjustment. The temp can be adjusted ± 35 °F (± 19 °C).
 - Tap **SETTINGS** > **Temp** > **Temperature Adjust**. Tap the current setting to raise/ lower the temp.

NOTE

- This adjustment will not affect broiling or self-cleaning temperatures. The adjustment will be retained in memory after a power failure.

12-hour energy Saving

If you accidentally leave the oven on, this feature will automatically turn off the oven after 12 hours during baking functions or after 3 hours during a broil function.

1. Touch **SETTINGS** and then tap **12-hour energy Saving** > **ON**.
2. The 12-hour energy saving icon will appear in the indicator area.

Help

Help provides useful tips and explanations on a specific item that you select.

- Troubleshooting
Tap a checkpoint directly on the screen, and try the suggestions.
- Guide for first use
Provides simple instructions on the basic use of the oven.

About device

You can see information about the oven and do a software update.

To update the software:

1. Tap **SETTINGS** > **About device** > **SW update** > **Update**.
2. Tap **INSTALL**. The software is updated; the system restarts automatically.

Sabbath

You can set Sabbath mode. (See **Using the Sabbath feature**, next page.)

Demo mode

This is for retail-display purposes only. (The heating element does not operate.)

Oven (Lower Oven)

Using the Sabbath feature

(For use on the Jewish Sabbath & Holidays)



For further assistance, guidelines for proper usage, and a complete list of models with the Sabbath feature, visit the web at <http://www.star-k.org>.

This feature is for baking use only. Oven temperature may be set higher or lower after the Sabbath feature is set. (Oven-temperature adjustment should be used only during Jewish holidays.) The display will not change, and tones will not sound. Once the oven is set for baking with the Sabbath feature active, the oven remains on continuously until the Sabbath feature is canceled. The Sabbath feature overrides the factory-preset, 12-hr energy-saving feature. If the oven light is needed during the Sabbath, tap **LIGHT** before activating the Sabbath feature. The oven light will stay on until the Sabbath feature is canceled. If the oven light is not needed, turn it off before activating the Sabbath feature.

How to use the Sabbath feature

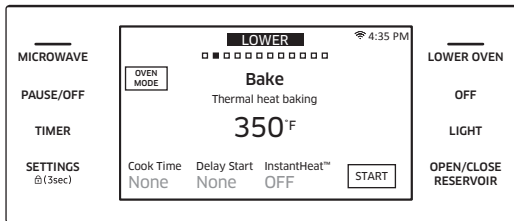

1. Tap **LOWER OVEN** and swipe the screen to Bake mode.

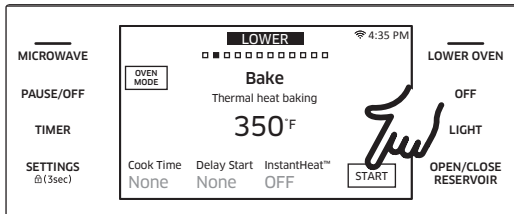

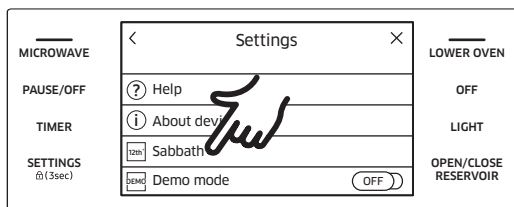

2. Set the temperature and cook time you want.
3. Tap **START**.

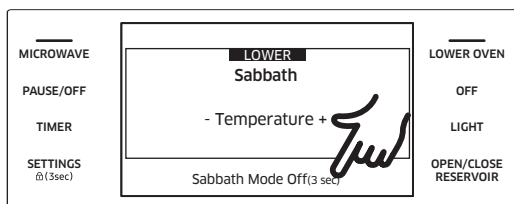

4. Tap **SETTINGS** > **Sabbath**. The oven will not beep or display any further changes. You may change the oven temp once baking starts.



5. Turn the oven off any time by tapping **OFF**. (Sabbath mode remains on.)
6. To turn Sabbath mode off, tap-hold **Sabbath Mode Off** for 3 seconds. (The oven also turns off.)

-  Do not attempt to activate any other program feature except Bake while the Sabbath feature is active.
- 
 - You can change the oven temperature, but the display will not change and tones will not sound when a change occurs. After you change the temperature while the unit is in Sabbath mode, there is a 15 second delay before the unit recognizes the change.
 - You can set the **Cook Time** function before activating the Sabbath feature.
 - Should you experience a power failure or interruption, the oven will shut off. When power is returned, the oven will not turn back on automatically. **Sabbath** will be displayed in the oven control display, but the oven will not operate. Food may be safely removed from the oven while it is still in the Sabbath mode, however the oven cannot be turned back on until after the Sabbath Holidays. After the Sabbath observance, turn off the Sabbath mode.
 - Tap and hold **Sabbath Mode Off** for 3 seconds.
-  Do not open the oven door or change the oven temperature for about 30 minutes after you have started Sabbath mode to allow the oven to reach the set temperature. Note that for best performance, the oven fan operates only when the oven temperature is rising.

Maintaining your appliance

Care and cleaning of the oven

Cleaning painted parts and decorative trim

- For general cleaning, use a cloth with hot, soapy water.
- For more difficult residue and built-up grease, apply a liquid detergent directly onto the area and leave for 30 to 60 minutes. Wipe with a damp cloth and dry. Do not use abrasive cleaners on any oven surfaces. They can be scratched.

Cleaning stainless-steel surfaces

1. Shake a bottle of stainless-steel appliance cleaner/polish.
2. Place a small amount of the cleaner/polish on a damp cloth or damp paper towel.
3. Clean a small area, rubbing with the grain of the stainless steel if applicable.
4. Dry and buff with a clean, dry paper towel or soft cloth.
5. Repeat as necessary.

NOTE

- **Do not use a steel-wool pad. It will scratch the surface.**
- If a mineral-oil-based, stainless-steel-appliance cleaner was used to clean the combi, wash the surface with liquid dish soap and water before using the cleaner again.

Oven racks

- If the racks go through a self-cleaning cycle, they will discolor somewhat and become dull. When the racks have cooled, rub their sides with wax paper or a cloth dabbed with a bit of cooking oil to help them glide more easily on their tracks.
- Gliding racks may be scrubbed with an abrasive cleaner or steel wool. Do not let water or cleaner enter the slides on the sides of rack.

NOTE

- Do not clean the racks in a dishwasher.
- If the rack becomes hard to remove or install, lightly wipe the guides with cooking oil. Do not wipe oil on the slides. (If the rack is still difficult to slide, it may need to be lubricated with graphite.)

NOTE

To order graphite lubricant, call Dacor Customer Assurance: 800-793-0093, or go to <http://www.dacor.com/Customer-Care/Service-Parts>, and search Part No. DG81-01629A.

Maintaining your appliance

To lubricate the slides of the gliding rack

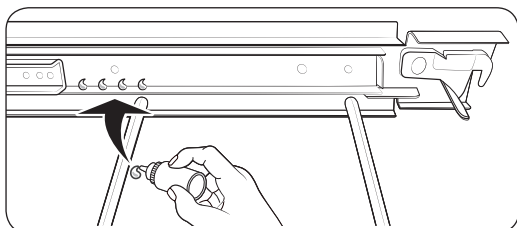
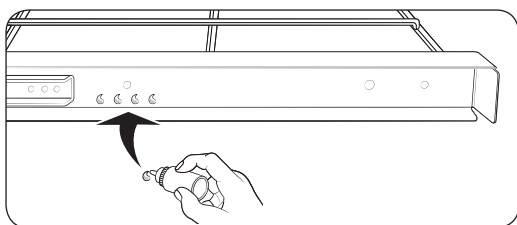
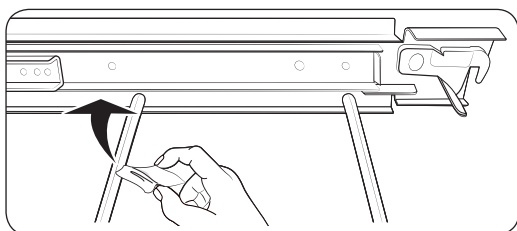
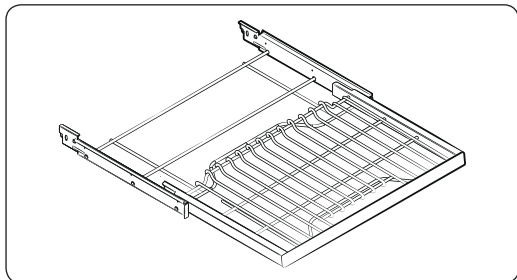

1. Remove the rack from the oven. See **Using the gliding rack > Removing the gliding rack**, pg. 70.
2. Fully extend the rack on a table or countertop. Newspaper may be placed underneath the rack for easy cleanup.
3. If there is debris in the slide tracks, wipe it away using a paper towel. (Any graphite lubricant wiped away must be replaced - See steps 4 through 7.)
4. Shake the graphite lubricant before opening it. Starting with the left (front and back) slide mechanism of the rack, place four (4) small drops of lubricant on the two (2) bottom tracks of the slide close to the bearing carriers.

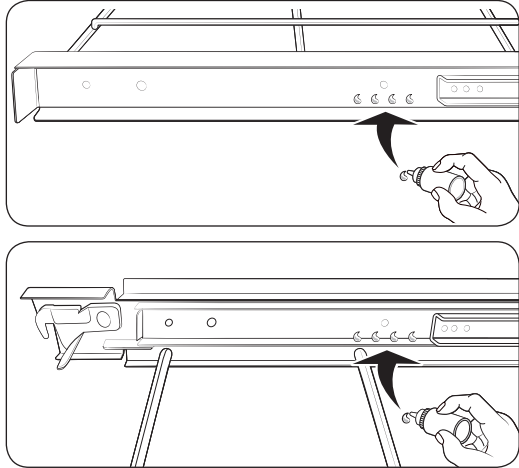

5. Repeat for the right (front and back) slide mechanism of the rack.
6. Open and close the rack several times to distribute the lubricant.
7. Replace the cap on the lubricant and shake it again. Turn the rack over and repeat steps 3, 4, 5, and 6.
8. Close the rack, turn the rack right-side up, and slide it into the oven. (See **Installing the gliding rack**, pg. 69.)

NOTE

Do not spray the gliding rack with cooking spray or other lubricant sprays.

Oven door

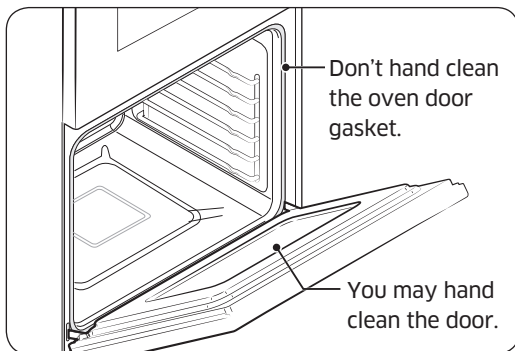

- Use soap and water to thoroughly clean the top, sides, and front of the oven door. Rinse well. You may use a glass cleaner on the outside glass of the oven door. **DO NOT immerse the door in water. DO NOT spray or allow water or the glass cleaner to enter the door vents.** DO NOT use oven cleaners, cleaning powders, or any harsh abrasive cleaning materials on the outside of the oven door.
- **DO NOT clean the oven-door gasket.** The oven-door gasket is made of a woven material which is essential for a good seal. Care should be taken not to rub, damage, or remove this gasket.

Maintaining your appliance

Removing the oven door (Lower oven only)

CAUTION

Follow these instructions carefully to avoid personal injury and property damage. For safety reasons, you cannot remove the door of the upper oven.

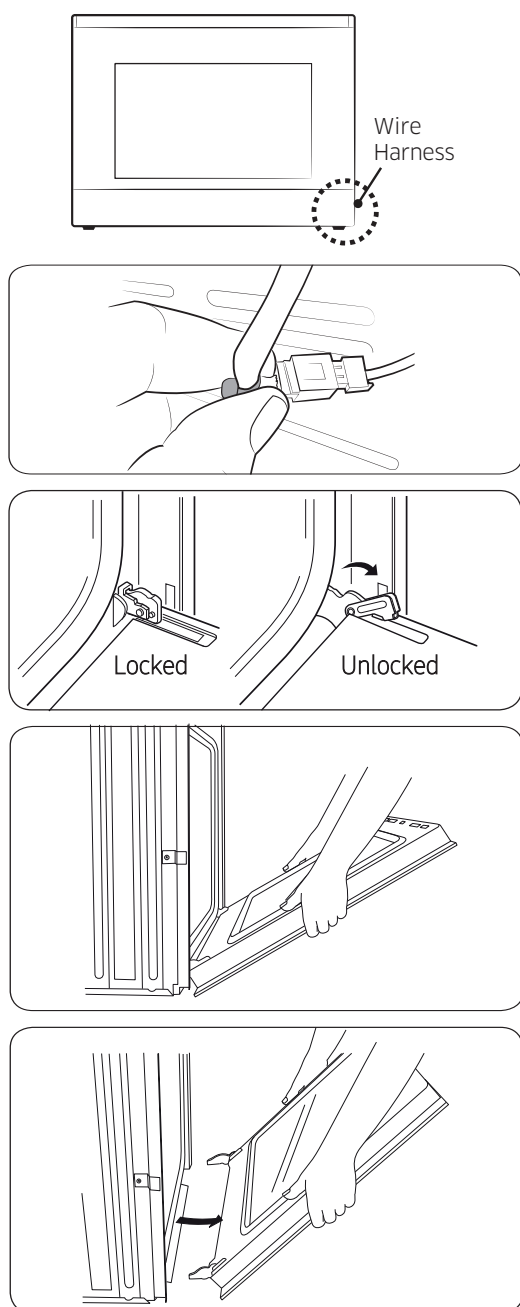

1. Prepare a flat, blanket-covered surface to set the door on. (You can also use the corner posts from your packing material.)
2. Disconnect the LED's wire harness from the door's bottom-right corner.
3. Open the oven door.
4. In both corners of the door, flip the hinge locks outward to unlock them. The hinge locks must be flipped fully out (see the graphic at left) so you can remove the door properly.
5. Partially close the door to engage the door latch locks. The door will stop at this point.
6. Using two hands, grasp the sides of the oven door. Lift and pull the oven door toward you and remove. You may need to gently shift the door from side to side as you pull.
7. Set the oven door aside on the prepared covered work surface with the oven door resting on its handle.

Maintaining your appliance

Replacing the oven door (Lower oven only)

Follow these instructions carefully to avoid personal injury and property damage. For safety reasons, you cannot remove the door of the upper oven.

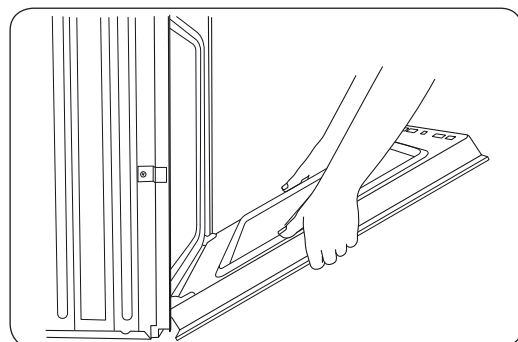
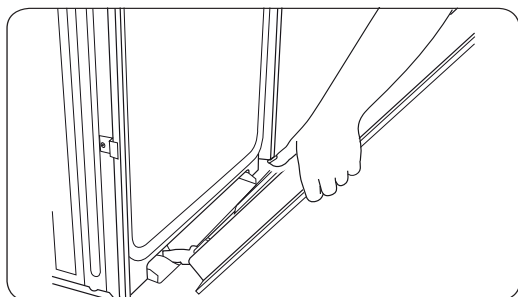
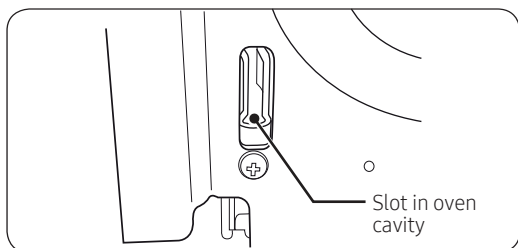

1. Using two hands, grasp the side edges of the door at the midpoint. Face the oven cavity.
2. Locate the slots on each side of the oven cavity for the door hinge locks.
3. Hold the door at a 45° angle, and then align the door hinges with the slots in the lower front of the oven cavity. Slowly insert the door, making sure you maintain the 45° angle. You will know the door is engaged in the slot when you feel a slight drop.
4. Fully open the oven door. (If the door does not open 90°, repeat Steps 1 – 3.)
5. Flip the hinge locks in the bottom corners of the oven door toward the oven chamber to lock the hinges. See Step 3 (Locked/Unlocked) in the **Removing the oven door** procedure.
6. Close the oven door. (If the door is properly installed, there is an even gap between it and control panel; if the gap is fatter on one side, the hinge on that side is improperly installed.)
7. Reconnect the LED's wire harness.

CAUTION

After replacing the door, make sure to reconnect the wires. Push them inward to arrange them as they were before you removed the door. Wires that are not connected or arranged correctly can be caught in the door or damaged by heat.

Maintaining your appliance

Changing the oven light (Lower oven only)

The oven light is a standard 40-watt-appliance halogen bulb. It comes on when the oven door is open. When the oven door is closed, touch **LIGHT** to turn the light on or off. It will not work during a self-cleaning or Green cleaning cycle.

CAUTION

Before changing your oven light, disconnect the electrical power to the oven at the main fuse or circuit breaker panel. Make sure the oven and the halogen bulb are cool.

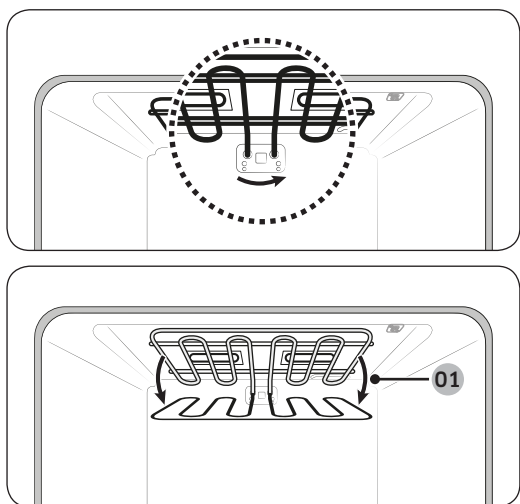

1. To change the halogen bulb, you must tilt the broil heater down. To do this, turn the circular nut on the support counterclockwise while holding the broil heater. The broil heater should loosen and tilt down.
Important: The broil heater is not a removable part. Do not force the broil heater down. Do not let it drop down.
2. Remove the glass cover.
3. Remove the halogen bulb cover.
4. Replace the halogen bulb.
5. When done, replace the glass cover, and then follow Step 1 above in the reverse order to return the broiler to its correct position.

Troubleshooting

If the oven malfunctions or has performance issues, review the tables in this section. If you cannot resolve the issue yourself, call Dacor Customer Assurance, (800) 793-0093.

Control display

| Problem | Possible cause | Solution |
|-----------------------------------------|-------------------------------------------------------------------------------------------------------------------------|-----------------------------------------------------------------------------------------------------------------------|
| The display goes blank. | Blown fuse or tripped circuit breaker. | Replace the fuse or reset the circuit breaker. |
| Touch-controls do not respond to touch. | <ul style="list-style-type: none"> • Touch model: Moisture on control panel • Lock function set | <ul style="list-style-type: none"> • Remove the moisture; try again. • Release lock function. |

For the microwave oven

| Symptom | Cause | Action |
|---------------------------------------------------|-------------------------------------------------------------------------------|-----------------------------------------------------------------------------------------------------------------------------------------------|
| General | | |
| Touch-controls do not respond to touch. | Touch models: Moisture on control panel. | Wipe moisture from exterior. |
| | Child lock activated. | Deactivate Child lock. |
| The oven does not work. | Power not supplied. | Verify there is power and oven is plugged in; check for blown fuse /tripped circuit breaker. |
| | Door is open. | Close door, and retry. |
| | Door-open safety mechanisms covered in foreign matter. | Remove foreign matter, and retry. |
| Oven stops during operation | User opened door to turn food. | Turn food; tap Start to resume operation. |
| Power turns off during operation. | Oven has been on for extended period. | After cooking for an extended period, let oven cool. |
| | Cooling fan not working. | Listen for sound of cooling fan. |
| | No food in oven. | Put food in the oven. |
| | Insufficient ventilation space for oven. | For intake/exhaust vents on front/rear of oven, keep gaps specified in installation instructions. |
| | Several power plugs used in same outlet. | Designate one socket for oven. |
| Popping sound during operation; oven not working. | Cooking sealed food or using a container with a lid may cause popping sounds. | Remove lids so containers do not burst. |
| Oven exterior too hot during operation. | Insufficient ventilation space for oven. | For intake/exhaust vents on front/rear of oven, keep gaps specified in installation instructions. |
| Door not opening properly. | Food residue stuck between door and oven chassis. | Clean area, then open door. |
| Heating (incl. Warm function) does not work. | Oven may not work, too much food being cooked, or improper cookware used. | Put 1 C water in microwave-safe bowl; run oven 1 min. to verify that water heats; use less food; restart function. Use flat-bottom container. |
| Thaw function not working. | Too much food being thawed. | Reduce amount of food, and retry function. |

Troubleshooting

| Symptom | Cause | Action |
|----------------------------------------------------------------|-------------------------------------------------------------------------------|------------------------------------------------------------------------------------------------------------|
| The interior light dim or non-functioning. | Door left open for long time. | Interior light may automatically turn off during Eco function operation; close/reopen door, or tap CANCEL. |
| | Interior light covered by residue. | Clean oven chamber, and recheck. |
| Beeping sound during cooking | If Auto Cook is active, beep means it is time to turn food during thawing. | After turning food, press the START button again to restart operation. |
| Oven not level. | Oven installed on uneven surface. | Verify surface below oven is even and stable. |
| Sparks during cooking. | Metal containers are used during oven/thawing functions. | Do not use metal containers. |
| When power is connected, oven instantly starts working | Door not closed properly. | Close door and recheck. |
| There is electricity coming from the oven. | The power or outlet not properly grounded. | Ensure power and outlet are properly grounded. |
| Water drips. Steam leaves via a door crack. Water in the oven. | There may be water/steam depending on type of food. This is normal. | Let oven cool, then wipe with dry towel. |
| Brightness in oven varies | Brightness varies depending on power output and selected function. | Power output variations during cooking are not malfunctions. |
| Cooling fan runs after cooking is done. | To ventilate oven, cooling fan keeps running 3 min. after cooking is done. | No action; this is normal. |
| Optitray | | |
| While turning, optitray derails or stops turning. | Missing/improperly installed roller ring. | Install/fix roller ring, then retry. |
| Turntable drags. | Roller ring improperly set, food too heavy, or container contacts oven walls. | Remove some food. Use smaller container. |
| Turntable rattles as it turns. | Food/residue on bottom of oven. | Remove residue. |
| Broiling | | |
| Smoke comes out during operation. | During initial operation, smoke may come from heating elements. | This is normal. After you run the oven 2-3 times, it should stop. |
| | Food is on heating elements. | Let oven cool; remove food from heating elements. |
| | Food too close to grill. | Put food a suitable distance from grill. |
| | Food improperly prepared/arranged. | Prepare and arrange food properly. |

Troubleshooting

| Symptom | Cause | Action |
|----------------------------------------------|---------------------------------------------------------------------|-------------------------------------------------------------------------------------------|
| Convection | | |
| Oven does not heat. | Door is open. | Close door; retry. |
| Smoke comes out during preheating. | During initial operation, smoke may come from the heating elements. | This is normal. After you run the oven 2-3 times, it should stop. |
| | Food is on the heating elements. | Let oven cool; remove food from heating elements. |
| Smell of burning or plastic when using oven. | Plastic or non-heat-resistant cookware used. | Use glass cookware suitable for high temps. |
| Bad smell from inside oven. | Food residue or plastic has melted and stuck to interior. | Run Steam Bake for 1 hr, and wipe with dry cloth. Put in lemon slice to help remove odor. |
| Oven not cooking properly. | Oven door frequently opened when cooking. | For best results, cook with the door closed. |
| | Oven controls incorrectly set. | Reset oven controls and try again. |
| | Broil heater or other accessories incorrectly inserted. | Correctly insert the accessories. |
| | Wrong size/type of cookware used. | Use suitable cookware with flat bottoms. |

For the lower oven

| Problem | Possible cause | Solution |
|----------------------------------|----------------------------------------------------------------|------------------------------------------------------------------------------|
| Oven will not turn on. | The oven is not completely plugged into the electrical outlet. | Ensure electrical plug is inserted in live, properly grounded outlet. |
| | Blown fuse/tripped circuit breaker. | Replace fuse or reset circuit breaker. |
| | Oven controls improperly set. | See Basic operations , starting on pg.19. |
| | The oven is too hot. | Allow the oven to cool. |
| | Incomplete service wiring. | Call for service. |
| | Power outage. | Check to see if house lights turn on. Call local electric company if needed. |
| Oven light will not turn on. | The light is loose or defective. | Tighten/replace lamp; call for service if door light will not turn on. |
| | Broken light switch. | Call for service. |
| Excessive smoke during broiling. | Oven controls improperly set. | See Basic operations , starting on pg.19. |
| | Meat placed too close to element. | Reposition rack; preheat broil element for searing. |
| | Meat was not properly prepared. | Trim excess fat from meat. |
| | Grease buildup on oven surfaces. | Regular cleaning is needed when broiling frequently. |

For the lower oven

| Problem | Possible cause | Solution |
|------------------------------------------------------------------------|----------------------------------------------------------------------------------------|-------------------------------------------------------------------------------------------------------------------------------------------|
| Food not baking/roasting properly. | The oven controls not set correctly. | See Basic operations , starting on pg.19. |
| | Oven rack not properly installed. | See Using the oven racks , pg. 68 |
| | Oven thermistor needs adjusting. | See Settings > Temp , pg. 81. |
| Food not broiling properly | Serving size may be inappropriate. | See Broiling recommendation guide for serving sizes, pg. 60, and retry. |
| | The rack is improperly positioned. | See Broiling recommendation guide , pg. 60. |
| | Cookware is unsuitable for broiling. | Use suitable cookware. |
| | In some areas, the voltage may be low. | Preheat broiler 10 min.; see Broiling recommendation guide , pg. 60. |
| Oven temp too hot/too cold. | The oven thermistor needs to be adjusted. | See Settings > Temp , pg. 81. |
| - Dripping water - Steam from door seam - Water remains in oven. | Water/steam may appear depending on food being cooked. This is normal. | Let oven cool; wipe with dry towel. |
| Boiling water heard during steam cooking | Water is being heated by steam heater. | This is normal function. |
| The oven will not self-clean. | The oven temperature is too high to start a self-clean operation. | Allow the oven to cool and then reset the controls. |
| | The oven controls have been set incorrectly. | See Self clean , pg. 71. |
| | Self-cleaning cycle cannot start if Oven control lockout is active. | Deactivate Oven control lockout , pg. 33). |
| Excessive smoking during a self-cleaning cycle. | Excessive soiling in the oven. | Press OFF . Open windows to vent smoke. Wait until self-cleaning cycle is canceled. Wipe up soil, and restart self-cleaning cycle. |
| Oven door stays shut after self-cleaning. | Oven is too hot. | Let oven cool. |
| The oven is not clean after a self-cleaning cycle. | Oven controls not set correctly. | See Self clean , pg. 71. |
| | Oven was heavily soiled. | Wipe up heavy spills; start self-cleaning cycle. Heavily soiled ovens may need another or a longer cycle. |
| Steam comes out of vent. | Convection mode is being used. | This is normal. |
| | More food means more steam emitted. | |
| Burning/oily odor from vent. | This is normal for a new oven and will disappear in time. | To hasten process, set a self-cleaning cycle for at least 3 hrs. See Self clean , pg. 71. |
| Strong odor. | Odor from insulation around inside of oven is normal for first few times oven is used. | Operate oven empty on bake setting at 400 °F for 1 hr. |
| Fan noise. | Convection fan turns itself on/off. | This is normal. |
| Oven racks not sliding easily. | The shiny, silver-colored racks were cleaned in a self-cleaning cycle. | Apply dab of veg. oil to paper towel, then wipe edges of oven racks. |
| Oven door locked. | Tripped circuit breaker or power outage when oven door was locked. | Activate Control Lockout, then unlock the control. See Oven Control Lockout , pg. 21. |

Information codes

OVEN

| Displayed code | Possible cause | Solution |
|----------------|---------------------------------------------------------------------|-------------------------------------------------------------------------------------------------------------------------------------------------------------------------------------------------------------|
| C-d0 | Occurs if control key is short for 1 min. | Clean screen; ensure no water is on/around it. Turn off oven and retry. If problem persists, contact a Dacor service center. |
| C-d1 | Occurs if door lock is mispositioned. | Press OFF, and then restart the oven. If the problem persists, disconnect all power to the oven for at least 30 seconds and then reconnect the power. If this does not solve the problem, call for service. |
| C-F0 | Occurs if communication between Main and Sub PBA is interrupted. | |
| C-F2 | Occurs if communication between Main and Touch is interrupted. | |
| C-10 | The cooking sensor is open when the microwave is operating. | |
| | The cooking sensor is short when the microwave is operating. | |
| C-20 | The oven sensor is open when the oven is operating. | |
| | The oven sensor is short when the oven is operating. | |
| C-21 | This code occurs if the internal temperature rises abnormally high. | |
| C-23 | The temp probe sensor is short when the oven is operating. | |
| C-30 | The PCB sensor is open when the oven is operating. | |
| | The PCB sensor is short when the oven is operating. | |
| C-31 | This code occurs if the PCB temperature rises abnormally high. | Call for service. |
| C-70 | The steam sensor is open when the oven is operating. | Press OFF, and then restart the oven. If the problem persists, disconnect all power to the oven for at least 30 seconds and then reconnect the power. If does not solve the problem, call for service. |
| | The steam sensor is short when the oven is operating. | |
| C-72 | There are drain system-related problems. | |
| C-A2 | The cooling motor is operating abnormally. | Call for service. |

Warranty and Service

Getting Help

Before you request service:

Review **Troubleshooting (pg. 90)**, and familiarize yourself with the warranty terms and conditions of your product. If your issue remains unresolved, direct your warranty and non-warranty questions to Dacor Customer Assurance:

Phone: (800) 793-0093 x2813 (US, Canada)

Hours of Operation: Mon – Fri, 5:00 am – 5:00 pm Pacific Time

Website: www.dacor.com/customer-care/contact-us

Warranty

What Is Covered

CERTIFICATE OF WARRANTIES: DACOR RANGETOPS

WITHIN THE 50 STATES OF THE U.S.A., THE DISTRICT OF COLUMBIA, AND CANADA*:

FULL 2-YEAR WARRANTY

This warranty applies only to the Dacor Modernist appliance sold to the original purchaser, from the date of the original retail purchase, or the closing date for new construction, whichever period is longer. The warranty is valid on Modernist products purchased new from a Dacor Authorized Dealer or other Dacor-authorized seller. If, within 2 years of the original purchase date, your Dacor Modernist appliance malfunctions due to material or manufacturing defect, Dacor will restore the appliance to its proper function at no cost to you.

All cosmetic damage (scratches on stainless steel, paint/porcelain blemishes, etc.) to the product or included accessories must be reported to Dacor within 60 days of the original purchase date to qualify for warranty coverage.

*Warranty is null and void if non-ETL- or non-CUL-approved appliance is transported from the USA.

LIMITATIONS OF COVERAGE

Service will be provided by a Dacor designated service company during regular business hours. Please note service providers are independent entities and are not agents of Dacor. Dealer display and model home display products with a production date greater than 5 years, products sold “As Is,” and products installed for non-residential use, which include but are not limited to religious organizations, fire stations, bed & breakfast, and spas carry a one year parts warranty only. All delivery, installation, labor costs, and other service fees are the responsibility of the purchaser.

Warranty will be null and void on product that has altered, defaced, or missing serial numbers and tags. The owner must provide proof of purchase or closing statement for new construction upon request. All Dacor products must be accessible for service.

Warranty and Service

LIMITATIONS OF COVERAGE

Warranty is voided if non-ETL or non-CUL approved product is transported from the U.S.A. OUTSIDE THE FIFTY STATES OF THE U.S.A, THE DISTRICT OF COLUMBIA, AND CANADA:

LIMITED FIRST YEAR WARRANTY

If your Dacor product malfunctions within 1 year of the original purchase date due to defective material/construction, Dacor will furnish a new replacement part, F.O.B. factory. The purchaser shall pay all delivery, installation, labor costs, and other service fees.

What Is Not Covered

- There may be slight color variations due to differences in painted parts, kitchen lighting, product placement, etc; this warranty does not apply to color variation.
- Service calls to educate the customer on proper use and care of the product.
- Service fees for travel to islands and remote areas, which include but are not limited to, ferries, toll roads or other travel expenses.
- Consequential or incidental damage, including but not limited to food or medicine loss, time away from work or restaurant meals.
- Failure of the product when used for commercial, business, rental or any application other than for residential consumer use.
- Failure of the product caused by improper product installation.
- Consumable parts (filters, light bulbs, etc.).
- Replacement of house fuses, fuse boxes or resetting of circuit breakers.
- Damage to the product caused by accident, fire, flood, power interruption, power surges or other acts of God.
- Liability or responsibility for damage to surrounding property including cabinetry, floors, ceilings and other structures or objects around the product.
- Breakage, discoloration, or damage to glass, metal surfaces, plastic components, trim, paint or other cosmetic finish caused by improper usage, care, abuse or neglect.

Out of Warranty

Contact us about any service issue beyond the standard warranty period. Dacor reviews all such cases to provide the best possible solution under the circumstances.

THE REMEDIES PROVIDED IN THE ABOVE EXPRESS WARRANTIES ARE THE SOLE AND EXCLUSIVE REMEDIES; THUS, NO OTHER SUCH WARRANTIES ARE MADE. OUTSIDE THE 50 UNITED STATES, DISTRICT OF COLUMBIA, AND CANADA, ALL IMPLIED WARRANTIES, (INCL. BUT NOT LIMITED TO: ANY IMPLIED WARRANTY OF MERCHANTABILITY OR FITNESS FOR A PARTICULAR USE OR PURPOSE) ARE LIMITED IN DURATION TO 1 YEAR FROM THE ORIGINAL PURCHASE DATE. IN NO EVENT SHALL DACOR BE LIABLE FOR INCIDENTAL EXPENSE OR CONSEQUENTIAL DAMAGES. SHOULD DACOR PREVAIL IN ANY LAWSUIT, DACOR SHALL BE ENTITLED TO REIMBURSEMENT OF ALL COSTS AND EXPENSES, INCLUDING ATTORNEY'S FEES, FROM THE DACOR CUSTOMER. NO WARRANTIES, EXPRESS OR IMPLIED, ARE MADE TO ANY BUYER FOR RESALE.

Some states do not allow limitations on how long an implied warranty lasts, or do not allow the exclusion or limitation of inconsequential damages; thus, the above limitations or exclusions may not apply to you. This warranty gives you specific legal rights, and you may also have other rights that vary from state to state.

Appendix

Open source announcement

The software included in this product contains open source software. You may obtain the complete corresponding source code for a period of three years after the last shipment of this product by sending an email to <mailto:oss.request@samsung.com>.

It is also possible to obtain the complete corresponding source code in a physical medium such as a CD-ROM; a minimal charge will be required.

The following URL <http://opensource.samsung.com/opensource/SimpleConnectTP/seq/0> leads to the download page of the source code made available and open source license information as related to this product. This offer is valid to anyone in receipt of this information.



Notes



Please visit www.Dacor.com to activate your warranty online.

WARRANTY INFORMATION



IMPORTANT:

Your warranty will not begin until you activate it online or return this form to Dacor. If you have purchased more than one Dacor product, please return all forms in one envelope, or activate the warranty for each product online.

Please rest assured that under no conditions will Dacor sell your name or any of the information on this form for mailing list purposes. We are very grateful that you have chosen Dacor products for your home and we do not consider the sale of such information to be a proper way of expressing our gratitude!

Owner's Name:

Street: _____
Last (Please Print or Type) First Middle

City: _____ State: _____ Zip: _____

Purchase Date: _____ Email: _____ Telephone: _____

Dealer: _____

City: _____ State: _____ Zip: _____

Your willingness to take a few seconds to fill in the section below will be sincerely appreciated. Thank you.

1. How were you first exposed to Dacor products? (Please check one only.)

- A. T.V. Cooking Show
- B. Magazine
- C. Appliance Dealer Showroom
- D. Kitchen Dealer Showroom
- E. Home Show
- F. Builder
- G. Architect/Designer
- H. Another Dacor Owner
- I. Model Home
- J. Other _____

2. Where did you buy your Dacor appliances?

- A. Appliance Dealer
- B. Kitchen Dealer
- C. Builder Supplier
- D. Builder
- E. Other _____

3. For what purpose was the product purchased?

- A. Replacement **only**
- B. Part of a Remodel
- C. New Home
- D. Other _____

4. What is your household income?

- A. Under \$75,000
- B. \$75,000 - \$100,000
- C. \$100,000 - \$150,000
- D. \$150,000 - \$200,000
- E. \$200,000 - \$250,000
- F. Over \$250,000

5. What are the brands of appliances that you have in your kitchen?

- A. Cooktop _____
- B. Oven _____
- C. Dishwasher _____
- D. Refrigerator _____

6. Would you buy or recommend another Dacor product?

- Yes
- No

Comments: _____

Thank you very much for your assistance. The information you have provided will be extremely valuable in helping us plan for the future and giving you the support you deserve.

Place Serial Number Label Here

Website: www.Dacor.com

Phone: 1+800+793-0093

cut here

cut here

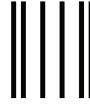

NO POSTAGE
NECESSARY
IF MAILED
IN THE
UNITED STATES

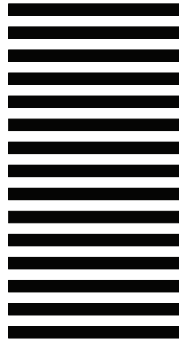

BUSINESS REPLY MAIL
FIRST-CLASS MAIL PERMIT NO 1600 CITY OF INDUSTRY CA

POSTAGE WILL BE PAID BY ADDRESSEE

DACOR
ATTN: WARRANTY PROCESSING DEPT
PO BOX 90070
CITY OF INDUSTRY, CA 91715-9907



fold here



DE68-04463A-01

