

CHILDREN'S ELECTRONIC TOY CAR

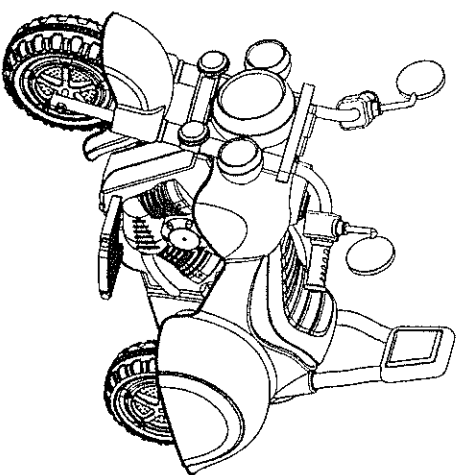

- Suitable for 3-7 years old
- Maximum user weight: 25kg

OWNER'S MANUAL

Read and understand this entire manual before using!

Please keep this manual for future reference as it contains important information.
Before first time use, charge the battery for at least 4-6 hours.



WARNING!

ASSEMBLY SHOULD BE DONE BY ADULT.

Table of Contents

1. About Your New Vehicle
2. Parts List
3. Parts Diagram
4. Assembly Steps
5. Label Decoration
6. How To Operation Your Vehicle
7. Charging The Vehicle
8. Troubleshooting Guide
9. Maintaining Your Vehicle
10. Disposal Of Battery

About Your New Vehicle

Thank you for your purchasing our products, we wants your child to enjoy this product for years to come. Keep these points in mind as you read this guide:









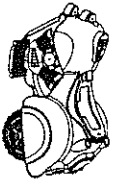
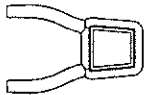
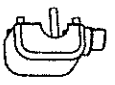
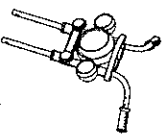

Suitable age:	3~7 Years old	Battery:	6V 4.5AH *1
Load Capacity:	Under 25kg	Size of car:	95*50*63 CM
Speed:	2.5KM/H	Power way:	Charging type
Charger:	Input: depend on local voltage Output: DC 6V500mA	Average battery life:	Approximately 300 times
Charge time:	8-12 Hours	Fuse:	5A

WARNING!

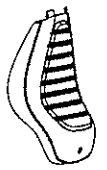
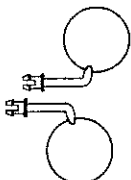

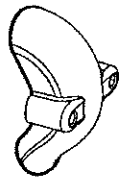



FOR THE SAFETY OF YOUR CHILD, PLEASE READ ALL WARNINGS AND ASSEMBLY/USE INSTRUCTIONS. KEEP THIS GUIDE FOR FUTURE REFERENCE.

- **ADULT ASSEMBLY REQUIRED.** The product contains small parts, which are for adult assembly only. Keep small children away when assembling.
- Always remove protective material and poly bags and dispose before assembly.

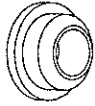
Parts List

PART NO.	PART NAME	PICTURE	Q'ty (pcs)	REMARKS
1	Vehicle body		1	
3	Backrest		1	
5	Mirror base (front)		2	
7	Handlebar		1	
9	Front wheel		1	
11	Bush		2	Placed on the handle bar
13	Ø10 nut		2	Placed on the handle bar
2	Seat		1	Placed on the vehicle body
4	Mirror		2	
6	Mirror base (back)		2	
8	Fender		1	
10	Front axle		1	Placed on the handle bar
12	Ø8 nut		1	Placed on the handle bar
14	M8X140 bolt		1	Placed on the handle bar

Parts List

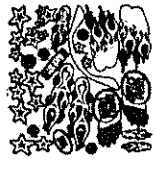
PART NO.	PART NAME	PICTURE	Q'ty (pcs)	REMARKS	PART NO.	PART NAME	PICTURE	Q'ty (pcs)	REMARKS
15	Iron bush		2	Placed on the handle bar	16	Ø3x8 screw		8	Placed in the assembly package
17	M5x12 machine screw		1	Placed on the seat	18	Charger		1	
19	M6x20 machine screw		2	Placed in the assembly package	20	Spanner		2	
21	Sticker		1						

Disposal Of Battery

Disposal Of Battery

- Your sealed lead-acid battery must be recycled or disposed of in an environmentally sound manner.
- Do not dispose of your lead-acid battery in a fire. The battery may explode or leak.
- Do not dispose of a lead-acid battery in your regular, household trash. The incineration, land filling or mixing of sealed lead-acid batteries with household trash is prohibited by law.
- Return an exhausted battery to your local approved lead-acid battery recycle, such as a local seller of automotive batteries.
- Contact your local waste management officials for other information regarding the environmentally sound recycling and disposal of lead-acid batteries.

Our products are suitable for ASTM F963 and CAPSIA.

WARNING

To reduce the risk of injury, adult supervision is required. Never use in roadways, near motor vehicles, on or near steep inclines or steps, swimming pools or other bodies of water, always wear shoes, and never allow more than 1 rider.

091014

Troubleshooting Guide

■ PROBLEM: The vehicle does not run very long.

POSSIBLE CAUSE: Battery may be undercharged.

You may not be charging the battery long enough. After each use, or once a month minimum, charge the battery for 8 to 10 hours. Do not leave the battery on the charger for more than 20 hours.

POSSIBLE CAUSE: Battery is old.

The battery will eventually lose the ability to hold a charge. Depending on the amount of use, and varying conditions, the battery should operate for one to three years. Replace the battery with a new one.

■ PROBLEM: Battery buzzes or gurgles when charging.

This is normal and not a cause for concern. It may also be silent when charging, which is also normal.

■ PROBLEM: Charger feels warm when recharging battery.

This is normal and not a cause for concern.

Maintaining Your Vehicle

- It is parents' responsibility to check main parts of the toy before using. Must regularly examine for potential hazard, such as the battery, charge cable or cord, plug, screws are fastening enclosure of other parts and that in the event of such damage, the toy must not be until that damage had been properly removed.
- Make sure the plastic parts of the vehicle are not cracked or broken.
- Occasionally use a lightweight oil to lubricate moving parts such as wheels.
- Park the vehicle indoors or cover it with a tarp to protect it from wet weather.
- Keep the vehicle away from sources of heat, such as stoves and heaters. Plastic parts may melt.
- Recharge the battery after each use. Only an adult can handle the battery. Recharge the battery at least once a month when the vehicle Raider is not being used.
- Do not wash the vehicle with a hose. Do not wash the vehicle with soap and water. Do not drive the vehicle in rainy or snowy weather. Water will damage the motor, electric system and battery.
- Clean the vehicle with a soft, dry cloth. To restore shine to plastic parts, use a non-wax furniture polish. Do not use car wax. Do not use abrasive cleaners.
- Do not drive the vehicle in loose dirt, sand or fine gravel which could damage moving parts, motors or the electric system.
- When not using, all the electrical source should be turn off. Turn off the power switch and disconnect the battery connection.

Parts Diagram

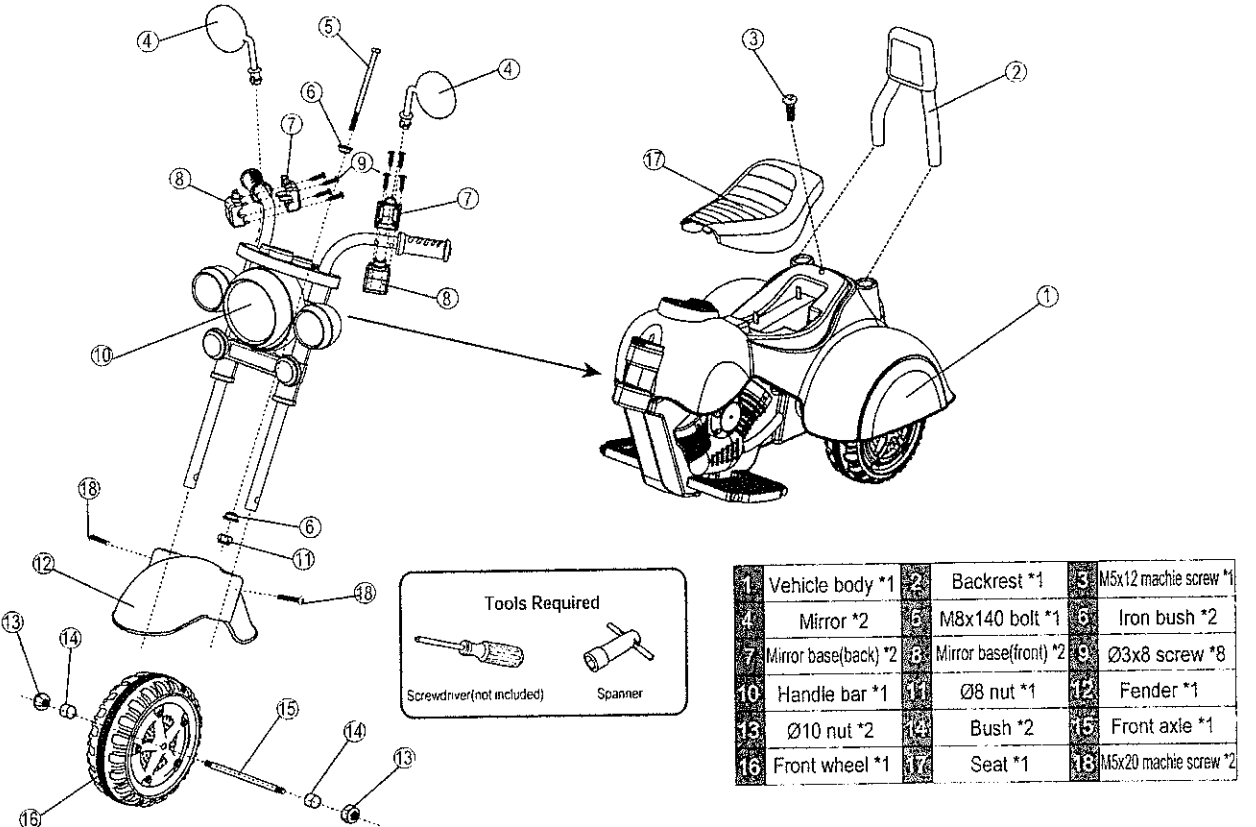

Assembly Steps

- Your new vehicle requires adult assembly. Please set aside at least 40 minutes for assembly. Children can be harmed by small parts, sharp edges and sharp points in the vehicle's unassembled state. Care should be taken in unpacking and assembly of the vehicle. Children should not handle parts, or help in assembly of the vehicle.
- Please identify all parts before assembly and save all packaging material until assembly is complete to ensure that no parts are discarded.
- Assembly tool for need: screwdriver(Not included) and spanner.

1. Battery assembly

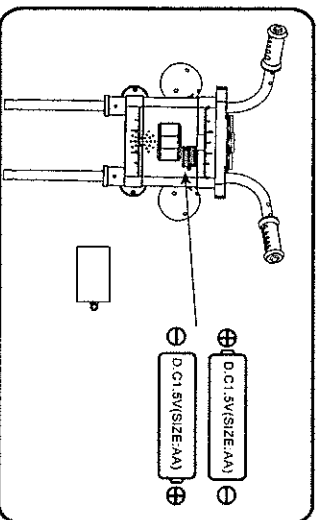

- Use a screwdriver to remove the battery cover, and insert two dry(AA) batteries.
- Replace the battery cover.

NOTE: The product does not include dry(AA) battery.

BATTERY INFORMATION

Batteries may leak fluids that can cause chemical burn injury or ruin your product. To avoid battery leakage:

Do not mix old and new batteries or batteries of different types: alkaline, standard (carbon-zinc) or rechargeable (nickel-cadmium).

Insert batteries as indicated inside the battery compartment.

Remove batteries during long periods of non-use. Always remove exhausted batteries from the product. Dispose of batteries safely. Do not dispose of batteries in a fire. The batteries may explode or leak.

- Never short-circuit the battery terminals.
- Non-rechargeable batteries are not to be recharged.
- Use only batteries of the same or equivalent type as recommended.
- Do not charge non-rechargeable batteries.
- Remove rechargeable batteries from the product before charging.
- If removable rechargeable batteries are used, they are only to be charged under adult supervision.

Troubleshooting Guide

■ PROBLEM: The vehicle does not run

PROBLEM CAUSE: The battery may low on power.

After each use, or once a month minimum, charge the battery for a full 10 hours. Do not leave the battery on the charger for more than 20 hours.

POSSIBLE CAUSE: Thermal fuse has tripped.

The vehicle is equipped with a self-resetting fuse. When the vehicle is overloaded or operated incorrectly, the self-resetting fuse will be cut off for 15-20seconds before becoming operational again. The self-resetting fuse is under the seal (Refer to the picture.)

To avoid the fuse cut off the power, follow these

guidelines:

- DO NOT overload the vehicle. Maximum weight allowed :25kg
- DO NOT tow anything behind the vehicle.
- DO NOT drive up steep slopes.
- DO NOT drive into fixed objects, which may cause the wheels to spin, causing the motor to overheat.
- DO NOT drive in very hot weather, components may overheat.
- DO NOT tamper with the electric system. Doing so may create a short circuit, causing the fuse to trip.

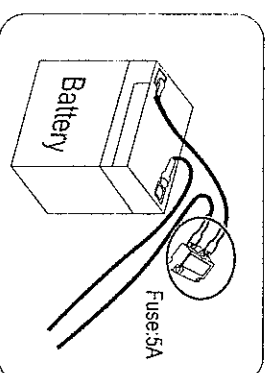

POSSIBLE CAUSE: Wheel nuts are loose.

If the nuts are not tight, the wheels will not engage the forward gears. Tighten the nut with the nut wrench.

POSSIBLE CAUSE: Battery connector or wires are loose.

Make Sure the battery connectors are firmly plugged in to each other.

POSSIBLE CAUSE: Battery is dead.

Have you properly maintained the battery according to the directions? Is the battery old? Your battery may need to be replaced.

POSSIBLE CAUSE: Electric system is damaged.

Water may have corroded the system, or loose dirt, gravel or sand might have jammed the switch.

POSSIBLE CAUSE: Motor is damaged.

The motor needs professional repair.

■ **PROBLEM: The battery will not recharge.**

POSSIBLE CAUSE: Battery connector or adapter connector is loose.

Make sure the battery connector and adapter connector are firmly plugged together.

POSSIBLE CAUSE: Charger is not plugged in.

Make sure the charger is plugged into the wall outlet and the power flow to the outlet is on.

POSSIBLE CAUSE: Charger is not working.

Is the charger warm while charging? If not, the charger may be broken and may need to be replaced.

Charging Your Vehicle

- DO NOT charge the battery if any damage to parts has occurred.
- Do not allow the battery to drain completely. Recharge the battery after each use or once a month if not used regularly.
- Do not charge battery upside down.
- Always secure the battery with the bracket. Battery can fall out and injure a child if vehicle tips over.

- The charging input socket is ABOVE THE FOOT PEDAL.
- The POWER SWITCH must be turned in OFF position when charging.
- Before the first use, you should charge the battery for 4-6 hours. Do not recharge the battery for more than 10 hours to avoid overheating the charger.
- When the vehicle begins to run slowly, recharge the battery.
- After each use or once a month minimum recharge time as 8 to 12 hours, less than 20 hours at most.

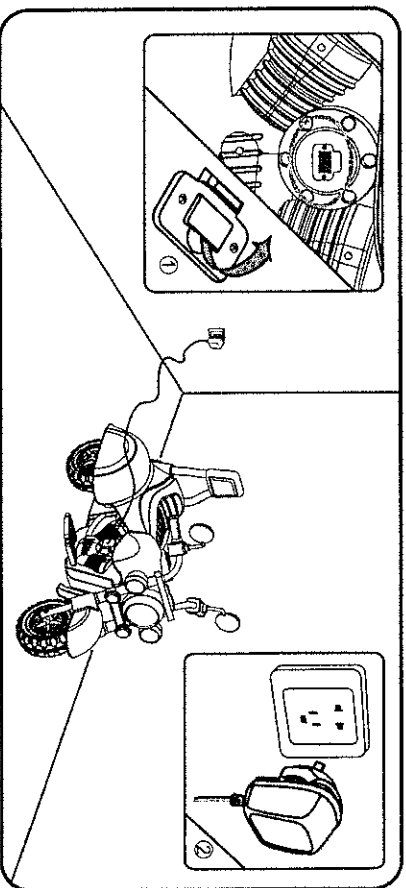

1. Open the cover of the socket (the socket is above the foot pedal.).
2. Plug the charger port into the input socket.
3. Plug the charger into a wall outlet. The battery will begin charging.

Assembly Steps

2. Fender assembly

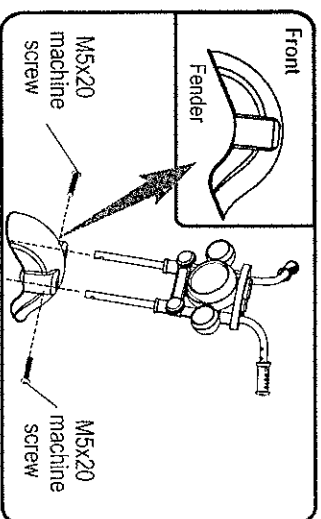

- Remove the front axle, bush, 2xØ10 nut from the handle bar.
- Fit the fender into the handle bar.
- Secure it with a M5x20 machine screw. Repeat for the other side.

3. Front wheel assembly

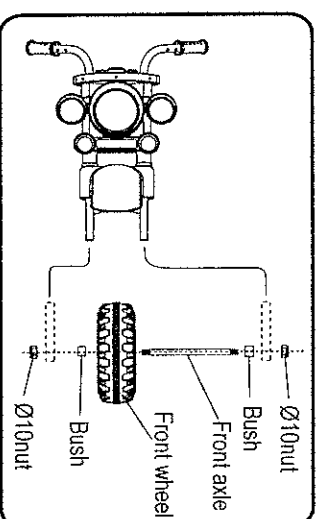

- Insert the front wheel into the handle bar.
- Place a bush on the hole in the middle of the front wheel, repeat for the other side.
- Insert the front axle through the handle bar, bush 2, and front wheel.
- Tighten a Ø10 nut(do not over tighten). Repeat for the other side.

4. Handle bar assembly

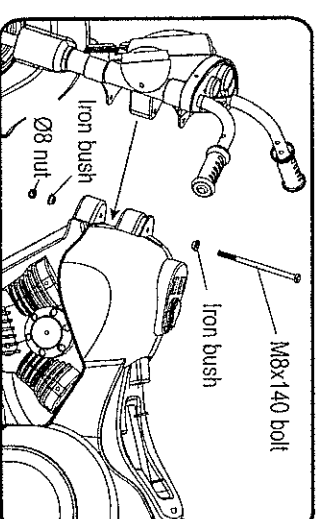

- Remove the M8x140 bolt, iron bush 2, and Ø8 nut from the handle bar.
- Fit the handle bar into the vehicle body.
- Slide a iron bush onto the M8x140 bolt.
- Insert the M8x140 bolt into the hole on vehicle body.
- Slide another iron bush and tighten the Ø8 nut on downside.

Assembly Steps

5. Mirror assembly

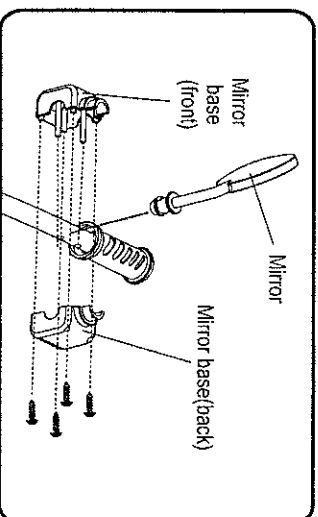

- Insert the mirror base(front) into the holes on handle bar.
- Fit the mirror into the mirror base(front).
- Fit the mirror(back) into the mirror(front).
- Use 4*Ø3x8 screws to secure it.
- Repeat for the other side.

6. Seat remove

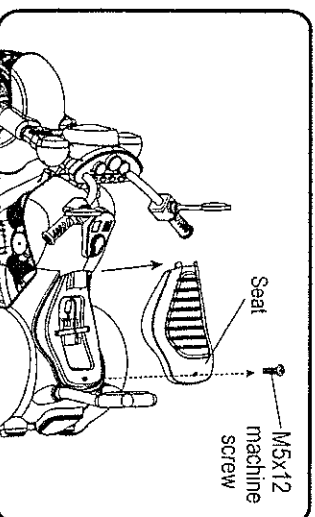

- Use a screwdriver to remove the M5x12 machine screw at the rear of the seat.
- Remove the seat.

7. Connect the power supply

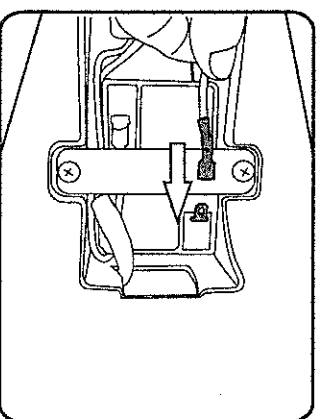

- Plug the connector into the terminal on battery as shown.
- Use a screwdriver to replace the seat.

Charging Your Vehicle

the electric system may cause a shock, fire or explosion or my permanently damage the system.

- Do not allow direct contact between battery terminals. Fire or explosion can occur.
 - Do not allow any type of liquid on the battery or its components.
 - Explosive gasses are created during charging. Do not charge near heat or flammable materials. Charge the battery in a well-ventilated area ONLY.
 - NEVER pick up the battery by the wires or charger. Damage can occur to the battery and may cause a fire. Pick up the battery by the case ONLY.
 - Charge the battery in a dry area ONLY.
 - Battery posts, terminals and related accessories contain lead and lead compounds, chemicals known to the State of California to cause cancer and reproductive harm.
- Wash hands after handling.**
- Do not open the battery. Battery contains lead acid and other materials that are toxic and corrosive.
 - Do not open the charger. Exposed wiring and circuitry inside case may cause electric shock. • Only adults may handle or charge the battery. NEVER allow child to handle or charge the battery. Battery is heavy and contains lead acid (electrolyte).
 - Do not drop the battery. Permanent damage to the battery could occur or cause serious injury.
 - Before charging the battery, check for wear or damage to the battery, charger, its supply cord and the connectors.

How To Operate Your Vehicle

Use Operation!(Ensure the power switch has been turned on)

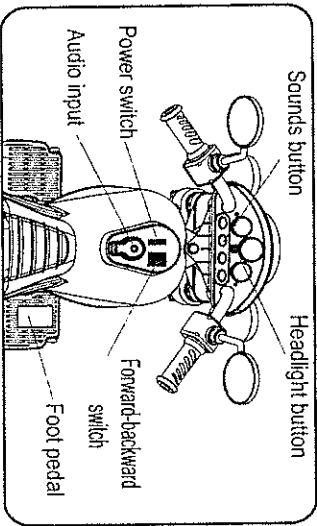

IMPORTANT!
Always stop vehicle when changing the speed or direction to avoid damage to gear box and motor.

FORWARD

1. Press the "Forward-backward switch" on the "Forward" position.
2. Press the "Foot pedal", the vehicle drives forward.

REVERSE

The vehicle will brake automatically, when your child's foot remove from the "Foot pedal".

STOP

1. Press the "Forward-backward switch" on the "Backward" position.

2. Press the "Foot pedal", the vehicle drives backward.

SOUNDS BUTTON

Press the buttons on the handle bar for sound playing.

HEADLIGHT BUTTON

Press the button on the handle bar to turn on the headlight; Press it again to turn the head light off.

Charging Your Vehicle

ONLY AN ADULT CAN CHARGE AND RECHARGE THE BATTERY!

⚠️ WARNING!

• PREVENT FIRE AND ELECTRIC SHOCK:

- Use the only rechargeable battery and charger supplied with your vehicle. NEVER substitute the battery or the charger with another brand. Using another battery or charger may cause a fire or explosion.
- Do not use the battery or charger for any other product. Overheating, fire or explosion could occur.
- NEVER modify the electric circuit system. Tampering with

Assembly Steps

8. Backrest assembly

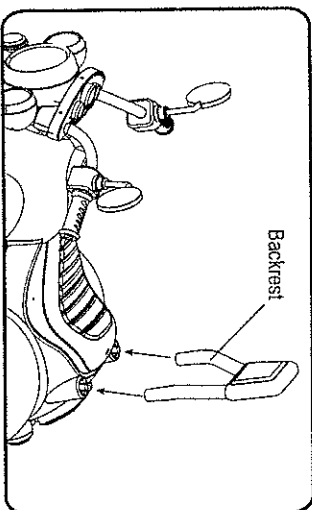

Fit the backrest into the holes on vehicle body. Push until you hear this click into place.

Label Decoration

- Wash your hands before applying the labels.
- Before applying the labels, wipe the surface of the vehicle with a clean, dry cloth to remove any dust or oils.
- Place the labels exactly as shown in the illustrations.



HINT: Some labels shown are applied on both sides of the vehicle.

Label Decoration

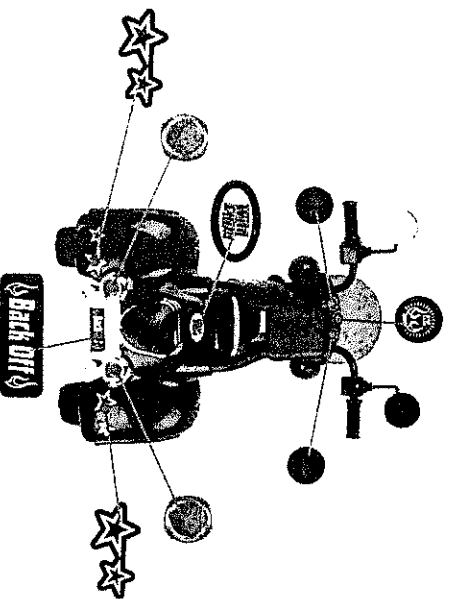

How To Operate Your Vehicle

⚠️ WARNING!

PREVENT INJURIES AND DEATHS:

- **NEVER LEAVE CHILD UNATTENDED. DIRECT ADULT SUPERVISION IS REQUIRED.** Always keep child in view when child is in vehicle.
- Never use in roadways, near cars, on or near steep inclines or steps, swimming pools or other bodies of water.
- Always wear shoes.
- Always sit on the seat.
- Suitable for age 3~7 years old; Maximum user weight is 25kg.

Must confirm before using that following work which is already finished:

- **Important!** Before using the vehicle for the first time, the battery needs to be charged for 4 to 6 hours, no more than 10 hours. Only an adult can charge or recharge the battery.
- Finishing the complete car to assemble according to the steps that the manual described. The plug-in package of storage battery has already been inserted well, the power has already been put through.
- All places to need the screw guarantee the screw has already been locked.

Rules for Safe Riding

READ THESE RULES ALOUD TO YOUR CHILD AND THEIR PLAYMATES AND MAKE SURE THEY UNDERSTAND THEM!

- Always wear a helmet when riding.
- Direct Adult Supervision Required.
- Keep Children within Safe Riding Areas:
- Never use in roadway, near motor vehicles, on lawn space, on or near steep inclines or steps, swimming pools or other bodies of water;
- Use the toy only on flat surfaces, such as inside your house, garden or playground.
- Never use in the dark. A child could encounter unexpected obstacles and have an accident. Operate the vehicle only in the daytime or a well-lit area.
- It is not recommended to drive the vehicle on wet surfaces or on lopes of greater than 15 degrees.
- Do not use this vehicle outdoors when it is raining or snowing.
- Make sure you come to a complete stop before changing directions from forward to back.
- Please follow the correct weight and age limits allowed to drive this vehicle.
- It is prohibited to change the circuit or add other electric parts
- Inspect wires and connections of the vehicle periodically.
- In order to avoid accidents, please ensure the vehicle is safe before riding.
- Do not let any child touch the wheels or be near them when the car is moving.