

SAMSUNG

Product Guide

32 cu. ft. Mega Capacity 3-Door French Door Refrigerator with Dual Auto Ice Maker

RF32CG5100

Available in:

Fingerprint Resistant Stainless Steel

Fingerprint Resistant Matte Black Steel



Table of Contents

Product Overview

| | |
|----------------------|---|
| Product Overview | 4 |
| Carousel Image Order | 5 |

Product Messaging

| | |
|-------------------------|----|
| Features and Benefits | 8 |
| Primary Lifestyle Image | 11 |

Product Specs

| | |
|------------------------------|----|
| Spec Sheet | 13 |
| <i>Will It Fit?</i> Guide | 14 |
| Energy Guide and User Manual | 15 |
| Warranty | 16 |

| | |
|----------------------|-----------|
| Feature Icons | 18 |
|----------------------|-----------|

Product Overview

**RF32CG5100 – 32 cu. ft. Mega Capacity 3-Door French Door
Refrigerator with Dual Auto Ice Maker**

Product Overview

Product Title

32 cu. ft. Mega Capacity 3-Door French Door Refrigerator with Dual Auto Ice Maker in Stainless Steel

32 cu. ft. Mega Capacity 3-Door French Door Refrigerator with Dual Auto Ice Maker in Matte Black Steel

Product Description (Paragraph)

Samsung Mega Capacity 3-Door French Door refrigerator features 32 cu. ft. capacity, Dual Auto Ice Maker and a modern design. Store more groceries, including big and bulky items. The Dual Auto Ice Maker makes two types of ice – cubed, or Ice Bites™ that chill your drink faster.*

Product Description (Bullets)

- 32 cu. ft. 3-Door French Door refrigerator in Stainless Steel or Matte Black Steel features America's largest capacity.**
- Dual Auto Ice Maker makes two types of ice – cubed, or Ice Bites™ that chill your drink faster.*
- A flat-front design with recessed drawer handle blends beautifully into your kitchen.
- 12% more space***

*Compared to cubed ice.

**In its class: full-depth French Door Refrigerator, less than \$4000 MAP

***Compared to 2022 model.

Easy Ads Links

Stainless Steel: <https://dam.gettyimages.com/p/z0c3461/digital-appliances?o=AND&q=RF32CG5100SR>

Matte Black Steel: <https://dam.gettyimages.com/p/z0c3461/digital-appliances?o=AND&q=RF32CG5100MT>

Available Colors



**Fingerprint Resistant
Stainless Steel**

RF32CG5100SR

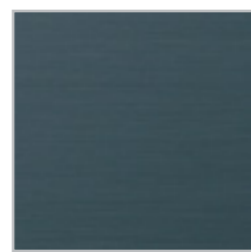

**Fingerprint Resistant
Matte Black Steel**

RF32CG5100MT



RF32CG5100SR Carousel Image Order





RF32CG5100MT Carousel Image Order





Product Messaging



**RF32CG5100 – 32 cu. ft. Mega Capacity 3-Door French Door
Refrigerator with Dual Auto Ice Maker**

Features and Benefits – RF32CG5100

| Overall Product Headline | Feature Name | Long Body Copy | Short Body Copy | Associated Image |
|---|--|--|---|---|
| <p>America's largest capacity refrigerator*</p> <p><small>*In its class: full-depth French Door Refrigerator, less than \$4000 MAP</small></p> | <p>32 cu. ft. Mega Capacity</p> | <p>Store more groceries with more room to stay organized. 32 cu. ft. mega capacity refrigerator gives you more space with easy access to everything you need.</p> | <p>32 cu. ft. mega capacity refrigerator stores more groceries with extra room.</p> |  |
| <p>Ice your way</p> | <p>Dual Auto Ice Maker</p> | <p>Enjoy your favorite beverage with your choice of ice. Choose from cubed ice, or Ice Bites™ which chill your drink faster.*</p> <p><small>*Compared to cubed ice</small></p> | <p>Get ice two ways – cubed or Ice Bites™.</p> |  |
| <p>Modern design</p> | <p>Modern Design</p> | <p>A flat-front fridge design with recessed drawer handle blends beautifully into the kitchen.</p> | <p>Modern fridge design with recessed drawer handle.</p> |  |

Features and Benefits – RF32CG5100 (Continued)

| Overall Product Headline | Feature Name | Long Body Copy | Short Body Copy | Associated Image |
|--|-----------------------------------|--|--|---|
| <p>Monitor and control energy usage</p> | <p>SmartThings Energy®</p> | <p>SmartThings lets you monitor and manage your smart refrigerator's power usage. Get energy saving tips and alerts to help lower your electric bill all from your phone.*</p> <p><small>*Available on Android and iOS devices. A Wi-Fi connection and a Samsung account are required.</small></p> | <p>SmartThings lets you monitor and manage your smart refrigerator's power usage all from your phone.*</p> <p><small>*Available on Android and iOS devices. A Wi-Fi connection and a Samsung account are required.</small></p> |  |
| <p>Store it all, short and tall</p> | <p>Slide-in Shelf</p> | <p>The adjustable slide-in shelves are flexibly designed to fit in just half of the fridge, so you can slide them back to create more room for tall and bulky items.</p> | <p>Adjustable shelves let you store tall items with ease.</p> |  <p data-bbox="2658 1226 2935 1253">Asset also available as .mp4.</p> |
| <p>Even cooling from corner to corner</p> | <p>All-Around Cooling</p> | <p>All-Around Cooling uses evenly spaced vents and monitors temperature continuously to ensure consistent cooling from corner to corner. This keeps the interior temperature the same throughout the fridge, so everything stays fresher, longer.</p> | <p>Cools refrigerator evenly from corner to corner, so food stays fresher, longer.</p> |  |

| Features and Benefits – RF32CG5100 (Continued) | | | | |
|--|-------------------------|--|-------------------------------------|--|
| Overall Product Headline | Feature Name | Long Body Copy | Short Body Copy | Associated Image |
| ADA Compliant | ADA Compliant | Easy-to-reach controls for everyone. | Easy-to-reach controls. |  |
| Digital Inverter Compressor with 10-year warranty | 10-year Warranty | Get a 10 year warranty on parts, and 5 years of coverage for labor, on the Digital Inverter™ Compressor. | 10-year warranty on the compressor. |  |

Primary Lifestyle Image

For use on marketing landing pages, category pages and offsite landing pages.



Stainless Steel (Preferred image for marketing usage.)



Matte Black Steel

Product Specs

**RF32CG5100 – 32 cu. ft. Mega Capacity 3-Door French Door
Refrigerator with Dual Auto Ice Maker**

Spec Sheet

RF32CG5100

32 cu. ft. Mega Capacity 3-Door French Door Refrigerator with Dual Auto Ice Maker



SAMSUNG

Signature Features

Mega 32 cu. ft. Capacity
Store more groceries with more room to stay organized. Mega 32 cu. ft. capacity fits big and bulky items with easy access to everything you need.

Dual Auto Ice Maker
Enjoy your favorite beverage with your choice of ice. Choose from cubed ice or Ice Bites™ that chill your drink faster.*
*Compared to cubed ice.

Modern Design
A flat-front design with low-profile door handles and recessed drawer handle fits seamlessly into your kitchen.

Available Colors

- Fingerprint Resistant Stainless Steel (shown)
- Fingerprint Resistant Matte Black Steel



Mega 32 cu. ft. Capacity



Dual Auto Ice Maker

Design

- Mega Capacity of 32 cu. ft.
- High-Efficiency LED Lighting
- Gallon Door Bin
- Fingerprint Resistant Finish

Technology

- Wi-Fi Enabled
- Power Cool & Power Freeze
- Door Alarm
- Water Filter Indicator

Performance

- Dual Auto Ice Maker with Ice Bites™ and Cubed Ice
- SmartThings Energy*

*Available on Android and iOS devices. A Wi-Fi connection and a Samsung account are required.





Rating



ENERGY STAR® rated:
709 kWh/yr

RF32CG5100

32 cu. ft. Mega Capacity 3-Door French Door Refrigerator with Dual Auto Ice Maker

SAMSUNG

Installation Specifications

1. Measure the height, width and depth of the opening, making sure to include baseboards, molding tile, countertop overhang, etc. Check to be sure there is enough room to open the door (consider walls, islands or other obstacles when measuring).
2. Refer to illustration below to determine dimensions.
3. Allow 2.5" of clearance on hinge side of refrigerator when installing next to a wall where handle may make contact.
4. Allow 1" minimum clearance at rear for proper air circulation and water/electrical connections. Allow a 3/8" minimum clearance at sides and top for ease of installation.
5. Ensure each door and entryway in the home is wide enough for the refrigerator to be moved through easily.

For optimal usage and ability to open refrigerator doors completely, do not install next to a wall.

Please note: The following dimensions and cutout information is for planning purposes only. For complete installation details, consult manual packed with product or download manual online at samsung.com.

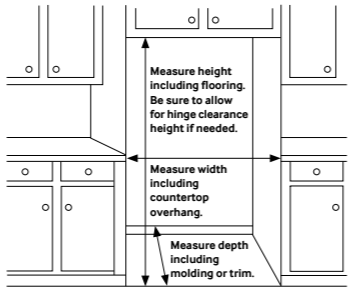

Dimensions

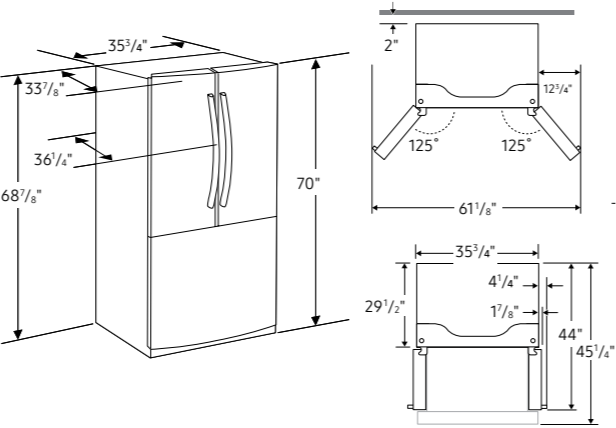

Total Capacity: 31.5 cu. ft.

Refrigerator: 22.3 cu. ft.

- 4 Tempered Glass Spill-Proof Shelves
- Full-Width Drawer
- 2 Clear Drawers
- 8 Door Bins
- Right: 1 Gallon Bin, 3 Regular Bins
- Left: 1 Gallon Bin, 3 Regular Bins
- High-Efficiency LED Lighting

Freezer: 9.2 cu. ft.

- Dual Ice Maker in Freezer (Cubed Ice or Ice Bites™)
- 2 Removable Ice Buckets and 1 Scoop
- 1 Large Opaque Bin with 1 Divider
- High-Efficiency LED Lighting

Accessories

Water Filter: HAF-QIN

Warranty

One (1) Year Parts and Labor on Refrigerator
Five (5) Years Parts and Labor on Sealed Refrigeration System Only*
Ten (10) Years Parts and Five (5) Years Labor on Digital Inverter Compressor

*Compressor, evaporator, condenser, drier and connecting tubing.

Product Dimensions & Weight

Dimensions (WxHxD with hinges, handles and doors):
35 3/4" x 70" x 36 1/4"

Dimensions (WxHxD without hinges and door):
35 3/4" x 68 7/8" x 29 1/2"

Dimensions (WxHxD with hinge and door, no handle):
35 3/4" x 70" x 33 7/8"

Weight: 289 lbs

Shipping Dimensions & Weight (WxHxD)

Dimensions: 37 7/8" x 75 1/8" x 36"

Weight: 299 lbs

| Color | Model # | UPC Code |
|---|--------------|--------------|
| Fingerprint Resistant Stainless Steel | RF32CG5100SR | 887276769301 |
| Fingerprint Resistant Matte Black Steel | RF32CG5100MT | 887276769295 |

Actual color may vary. Design, specifications, and color availability are subject to change without notice. Non-metric weights and measurements are approximate.
©2023 Samsung Electronics America, Inc., 85 Challenger Road, Ridgefield Park, NJ 07660. Tel: 800-SAMSUNG. samsung.com. Samsung is a registered trademark of Samsung Electronics Co., Ltd.

Spec Sheet - front

Spec Sheet - back

Will It Fit? Guide

32 cu. ft. 3-Door French Door Refrigerator MODEL RF32CG5100 DIMENSIONS



Be sure your new fridge will fit

Don't wait until delivery to be sure your new refrigerator will fit – both in your kitchen and through all doorways. This guide includes all pertinent measurements and clearances so you can buy with confidence.

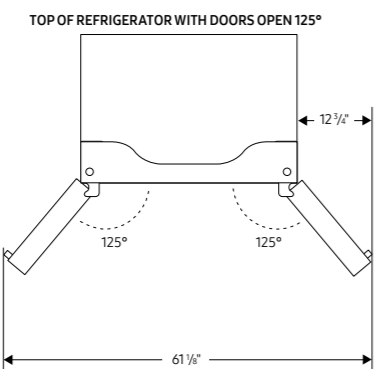
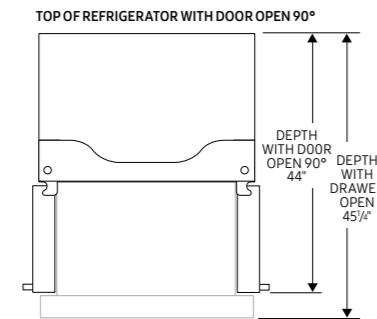
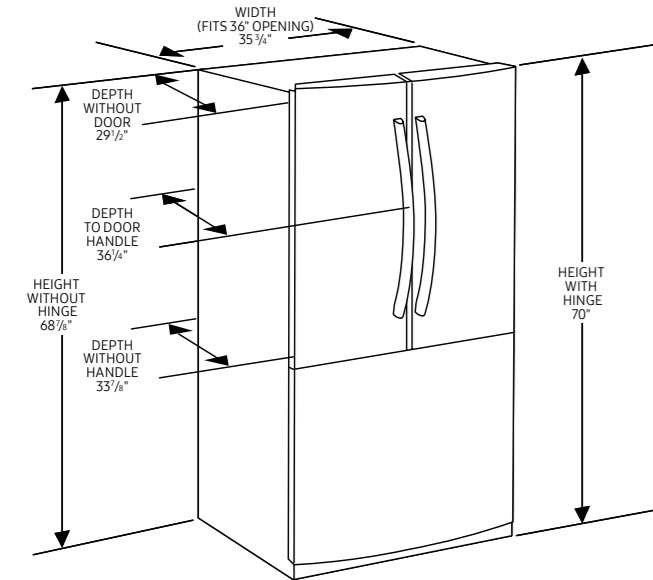

Standard-Depth Refrigerator

Standard-depth refrigerators typically measure 30 to 35 inches in depth, as opposed to counter-depth refrigerators that sit flush with cabinetry.

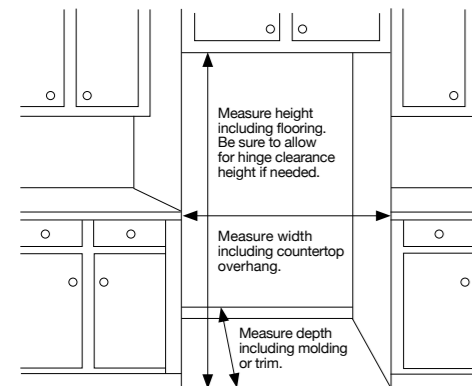

Installation clearances

- ✓ Allow 3 3/4" of clearance when installing along a wall. This will allow for the door to open 90 degrees without the handle contacting the wall.
- ✓ Allow 2" minimum clearance at rear for proper air circulation and water/electrical connections.
- ✓ Allow a 3/8" minimum clearance at sides and top for ease of installation.

For optimal usage and ability to open refrigerator doors completely, do not install next to a wall.

Please note: The above dimensions and cutout information is for planning purposes only. For complete installation details, consult manual packed with product or download manual online at samsung.com.

Walk the delivery route

- ✓ Identify the narrowest opening that the appliance will travel through, from outside the home to the location where it will be installed.
- ✓ Appliance depth or width must be smaller than the width of the narrowest opening.

Energy Guide and User Manual

U.S. Government Federal law prohibits removal of this label before consumer purchase.

ENERGYGUIDE

Refrigerator-Freezer Samsung
 • Automatic Defrost Model RF32CG5100**
 • Bottom-Mounted Freezer Capacity: 31.5 Cubic Feet
 • No Through-the-Door Ice

Compare ONLY to other labels with yellow numbers.
 Labels with yellow numbers are based on the same test procedures.

Estimated Yearly Energy Cost
\$99

| | | | |
|-------------|------------------------------|------|-------|
| Cost Ranges | Models with similar features | \$91 | \$101 |
| | All models | \$84 | \$124 |

709 kWh
 Estimated Yearly Electricity Use

- Your cost will depend on your utility rates and use.
- Both cost ranges based on models of similar size capacity.
- Models with similar features have automatic defrost, bottom mounted freezer, and no through-the-door ice.
- Estimated energy cost based on a national average electricity cost of 14 cents per kWh.

ftc.gov/energy



Energy Guide



Refrigerator

User manual

RF32CG*****/RF27CG*****

Free Standing Appliance

SAMSUNG

User Manual

Warranty

LIMITED WARRANTY (U.S.A.)

SAMSUNG REFRIGERATOR

LIMITED WARRANTY TO ORIGINAL CONSUMER PURCHASER WITH PROOF OF PURCHASE

This SAMSUNG brand product, as supplied and distributed by Samsung Electronics America, Inc. (SAMSUNG) and delivered new, in the original carton to the original consumer purchaser, is warranted by SAMSUNG against manufacturing defects in materials or workmanship for the limited warranty period of:

One (1) year parts and labor

Five (5) years parts and labor on Sealed Refrigeration System Only (Compressor, Evaporator, Condenser, Drier, and Connecting Tubing)

Ten (10) years part and Five (5) years labor on Digital Inverter Compressor Only

This limited warranty is valid only on products purchased and used in the United States that have been installed, operated, and maintained according to the instructions attached to or furnished with the product. To receive warranty service, the purchaser must contact SAMSUNG at the address or phone number provided below for problem determination and service procedures. Warranty service can only be performed by a SAMSUNG authorized service center. The original dated bill of sale must be presented upon request as proof of purchase to SAMSUNG or SAMSUNG's authorized service center to receive warranty service.

SAMSUNG will provide in-home service within the contiguous United States during the warranty period at no charge, subject to availability of SAMSUNG authorized servicers within the customer's geographic area. If in-home service is not available, SAMSUNG may elect, at its option, to provide transportation of the product to and from an authorized service center. If the product is located in an area where service by a SAMSUNG authorized servicer is not available, you may be responsible for a trip charge or required to bring the product to a SAMSUNG authorized service center for service.

To receive in-home service, product must be unobstructed and accessible to the service agent.

During the applicable warranty period, a product will be repaired, replaced, or the purchase price refunded, at the sole option of SAMSUNG. SAMSUNG may use new or reconditioned parts in repairing a product, or replace the product with a new or reconditioned product. Replacement parts and products are warranted for the remaining portion of the original product's warranty or ninety (90) days, whichever is longer. All replaced parts and products are the property of SAMSUNG and you must return them to SAMSUNG.

This limited warranty covers manufacturing defects in materials or workmanship encountered in normal household, noncommercial use of this product and shall not cover the following: damage that occurs in shipment, delivery, installation, and uses for which this product was not intended; damage caused by unauthorized modification or alteration of the product; product where the original factory serial numbers have been

Feature Icons

**RF32CG5100 – 32 cu. ft. Mega Capacity 3-Door French Door
Refrigerator with Dual Auto Ice Maker**

Feature Icons

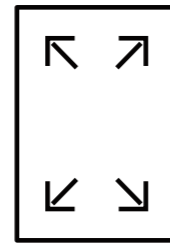

Mega Capacity

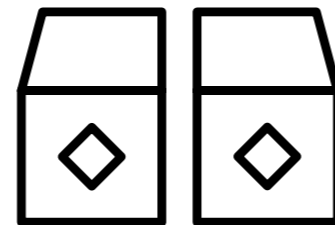

Dual Ice Maker

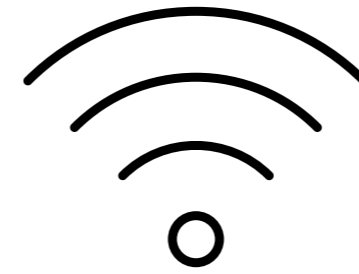

Wi-Fi Connectivity



10-Year
Compressor Warranty*

*10 years of warranty coverage on the compressor.

SAMSUNG