

Shark[®] CarpetXpert[™]

**EX200
EX201
SERIES**

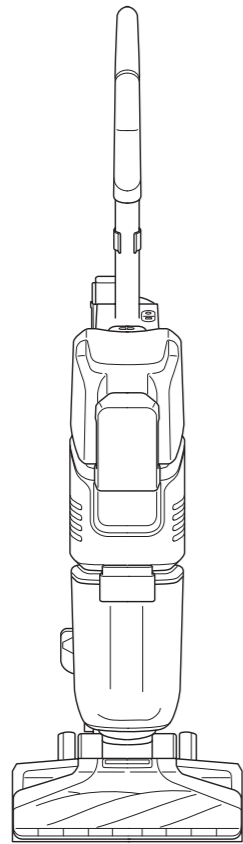

To view **HOW-TO VIDEOS** scan QR Code located on top of CarpetXpert Tank.

IMPORTANT SAFETY INSTRUCTIONS - FOR HOUSEHOLD USE ONLY

SAVE THESE INSTRUCTIONS.

READ CAREFULLY BEFORE USE. READ ALL INSTRUCTIONS BEFORE USING THIS CARPET CLEANER.

⚠ WARNING

To reduce the risk of fire, electric shock, injury, or property damage:

- If the power cord plug does not fit fully into the outlet, contact a qualified electrician. **DO NOT** force into outlet or try to modify to fit.
- To reduce the risk of shock and unintended operation, unplug before servicing.
- This carpet cleaner consists of a motorized nozzle, main body, pole, handle, hose, and hand tools. These components contain electrical connections, electrical wiring, and moving parts that potentially present risk to the user.
- Before each use, carefully inspect all parts for any damage. If a part is damaged, discontinue use.
- Use only identical replacement parts.
- DO NOT** use the carpet cleaner for any purpose other than those described in this Guide.
- DO NOT** immerse or spray water on the body of the carpet cleaner.
- To clean the surface, wipe with a dry cloth.
- Keep the carpet cleaner's cord out of reach of children.
- DO NOT** allow the appliance to be used by children. **DO NOT** allow to be used as a toy. Close supervision is necessary when used near children.
- This appliance can be used by persons with reduced physical, sensory or mental capabilities or lack of experience or knowledge if they have been given supervision or instruction concerning use of the appliance in a safe way and understand the hazards involved. Cleaning and user maintenance shall not be done by children.
- DO NOT** handle plug or carpet cleaner with wet hands.
- DO NOT** use without the dirty water tank, clean solution tank, filter, brushroll, and brushroll cover in place.
- Use only identical replacement parts. Only use Shark[®] branded filters and accessories.
- DO NOT** put any objects into nozzle opening. **DO NOT** use with any opening blocked; keep free of dust, lint, hair, and anything that may reduce airflow.
- DO NOT** use if nozzle airflow is restricted. If the air paths or the motorized floor nozzle become blocked, turn the carpet cleaner off. Remove all obstructions before you turn on the unit again. Keep nozzle and all carpet cleaner openings away from hair, face, fingers, uncovered feet, or loose clothing.
- DO NOT** use if carpet cleaner is not working as it should, or has been dropped, damaged, left outdoors, or dropped into water. Use extra care when cleaning on stairs.
- DO NOT** leave the carpet cleaner unattended while plugged in.
- When using on any surface, always keep the carpet cleaner moving to avoid damaging the surface (e.g., carpet fibers).
- DO NOT** place carpet cleaner on unstable surfaces such as chairs or tables. The surrounding area may be slippery and present a risk of injury.
- DO NOT** use to pick up:
 - Large objects.
 - Hard or sharp objects (glass, nails, screws, or coins).
 - Large quantities of dust (e.g., drywall dust).
 - Smoking or burning objects (hot coals, cigarette butts, or matches).
 - Flammable or combustible materials (lighter fluid, gasoline, or kerosene).
 - Toxic materials (chlorine bleach, ammonia, or drain cleaner).
- DO NOT** use in the following areas:
 - Poorly lit areas.
 - Outdoor areas.
 - Spaces that are enclosed and may contain explosive or toxic fumes or vapors (lighter fluid, gasoline, kerosene, paint, paint thinners, mothproofing substances, or flammable dust).
- Turn off the carpet cleaner before any adjustment, cleaning, maintenance, or troubleshooting.
- During cleaning or routine maintenance, **DO NOT** cut anything

other than hair, fibers, or string wrapped around the brushroll.

- DO NOT** modify or attempt to repair the carpet cleaner yourself. **DO NOT** use the carpet cleaner if it has been modified or damaged.
- Turn off all controls before unplugging.
- To reduce the risk of fire or electric shock due to internal component damage, use only Shark[®] cleaning fluid. See the Cleaning Fluid section of this Instruction Book.
- DO NOT** pull or carry by cord, use cord as a handle, close a door on cord, or pull cord around sharp edges or corners. **DO NOT** run appliance over cord. Keep cord away from heated surfaces.
- DO NOT** unplug by pulling on cord. To unplug, grasp the plug, not the cord.
- Use indoors only.
- DO NOT** use carpet cleaner on hard floors as it may damage your floor. To avoid damage to flooring and to avoid potential slip hazard, after use: (a) move to a hard sealed surface (avoid unsealed, wood and laminate) and (b) place unit on absorbent material like a towel to soak up any liquid.
- DO NOT** fill solution tanks while installed on the appliance. Remove before filling.
- The areas around where you are cleaning may become wet, use care to avoid slipping and falling.
- Use care when removing and reattaching the hand tool to avoid accidental activation of the cleaning solution. Do not spray solution on your skin or in your eyes.
- GROUNDING INSTRUCTIONS:** This appliance must be grounded. If it should malfunction or break down, grounding provides a path of least resistance for electric current to reduce the risk of electric shock. This appliance's cord has an equipment-grounding conductor and a grounding plug. The plug must be inserted into an appropriate outlet that is properly installed and grounded in accordance with all local codes and ordinances.
- WARNING:** Improper connection of the equipment grounding conductor can result in a risk of electric shock. Check with a qualified electrician or service person if you are in doubt as to

whether the outlet is properly grounded. **DO NOT** modify the plug provided with the appliance. If the plug will not fit the outlet, have a proper outlet installed by a qualified electrician.

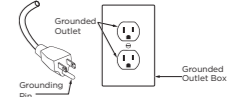

- This appliance is for use on a nominal V circuit and has a grounding attachment plug that looks like the plug illustrated below. Make sure that the appliance is connected to an outlet having the same configuration as the plug. No adaptor should be used with this appliance.
- DO NOT** immerse. To reduce risk of electric shock, use only on carpet moistened by cleaning.
- DO NOT** use vinegar in any tanks.
- DO NOT** run over edges of area rugs.
- Stalling the brush roll may result in premature failure.
- Avoid repeated strokes over the same area, to help prevent damage to Berber carpets.
- Check manufacturer's tag prior to cleaning area rugs for any specific cleaning guidelines. We do not recommend deep cleaning delicate rugs (including wool, cotton, silk, antique, or area rugs that do not have a manufacturer's tag).
- DO NOT** store unit where temperatures reach freezing levels to avoid damaging internal parts.
- FIRST AID** Keep out of reach of children. Causes skin and serious eye irritation. **IF IN EYES**, rinse continuously with water for minutes. Remove contact lenses if present and easy to do so. Continue rinsing. **IF ON SKIN**, wash with soap and water. If skin and eye irritation persists, seek medical attention. Please recycle container. Dispose of contents/container with a licensed waste disposal site in accordance with the requirements of the local waste disposal authority.
- DO NOT** dispose in drains or watercourses in concentrate form.

WHAT'S INCLUDED

What's Included: Shark[®] CarpetXpert, 12 oz. Shark Deep Clean Pro Solution, 16 oz. Shark OXY Multiplier, Hose-Cleaning Tool, Hand Tool(s)

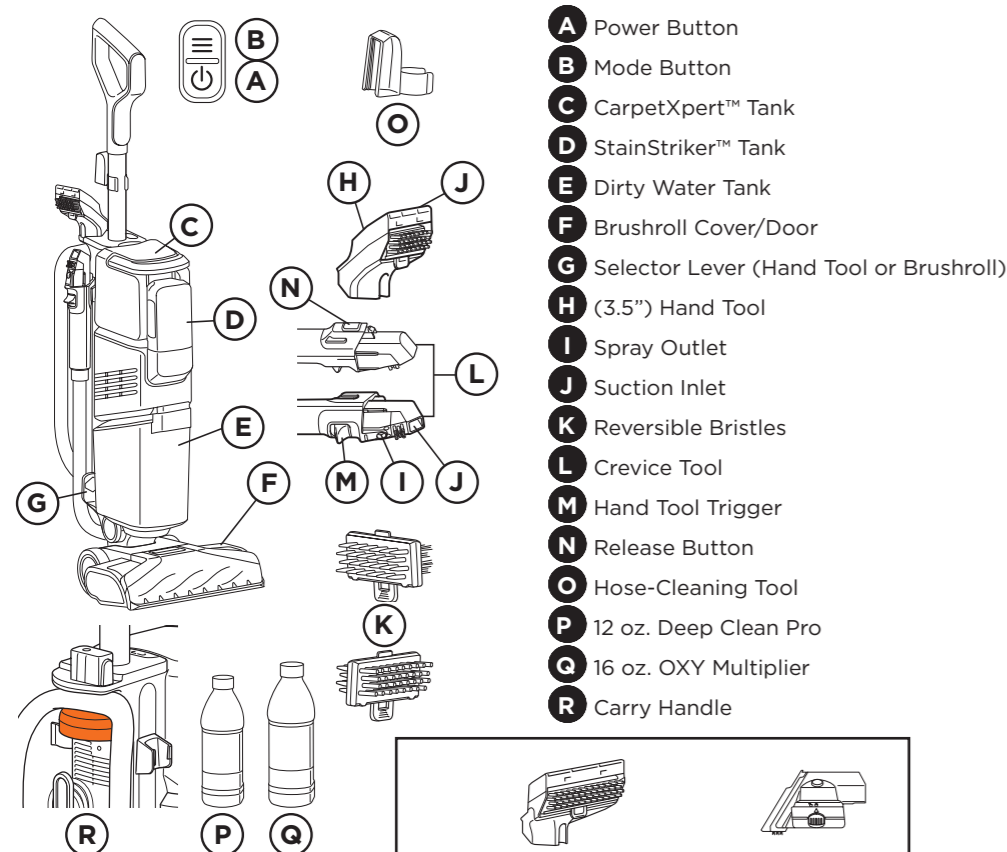

Shark 7" Wide-Path Tool and Shark Pet Tool included with select models, and available for purchase at www.sharkclean.com.

ASSEMBLY

Note: When assembling your CarpetXpert, there may be a little water in or around the water tanks. This is because we test all units before shipping to ensure the highest quality.

- Insert pole into the top of unit until it clicks into place (**fig. 1**). Make sure the pole is properly installed to prevent it from falling out during use.
- Store the hose-cleaning tool by clipping it onto the pole (**fig. 2**).
- Attach 3.5" hand tool to crevice tool, or store it on the tool holder (**fig. 3, 4**).
- Be sure the rubber seal is seated in place under the dirty water tank (**fig. 5**).
- Install the dirty water tank by placing the bottom on the nozzle lip (**fig. 6**) then tilting it forward until it clicks into place.

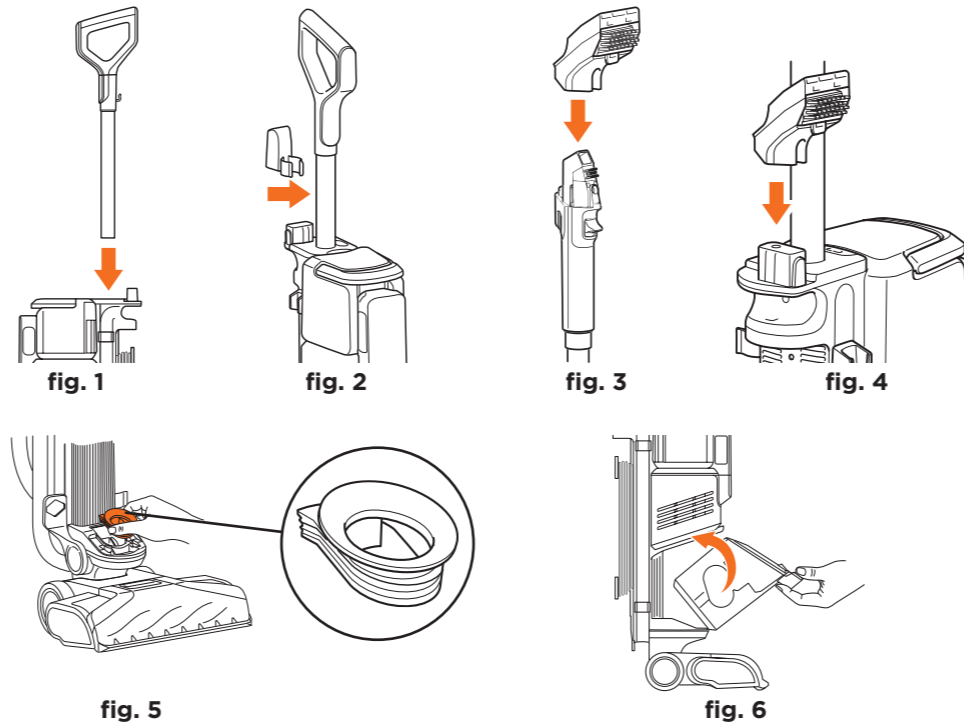

HOSE ASSEMBLY

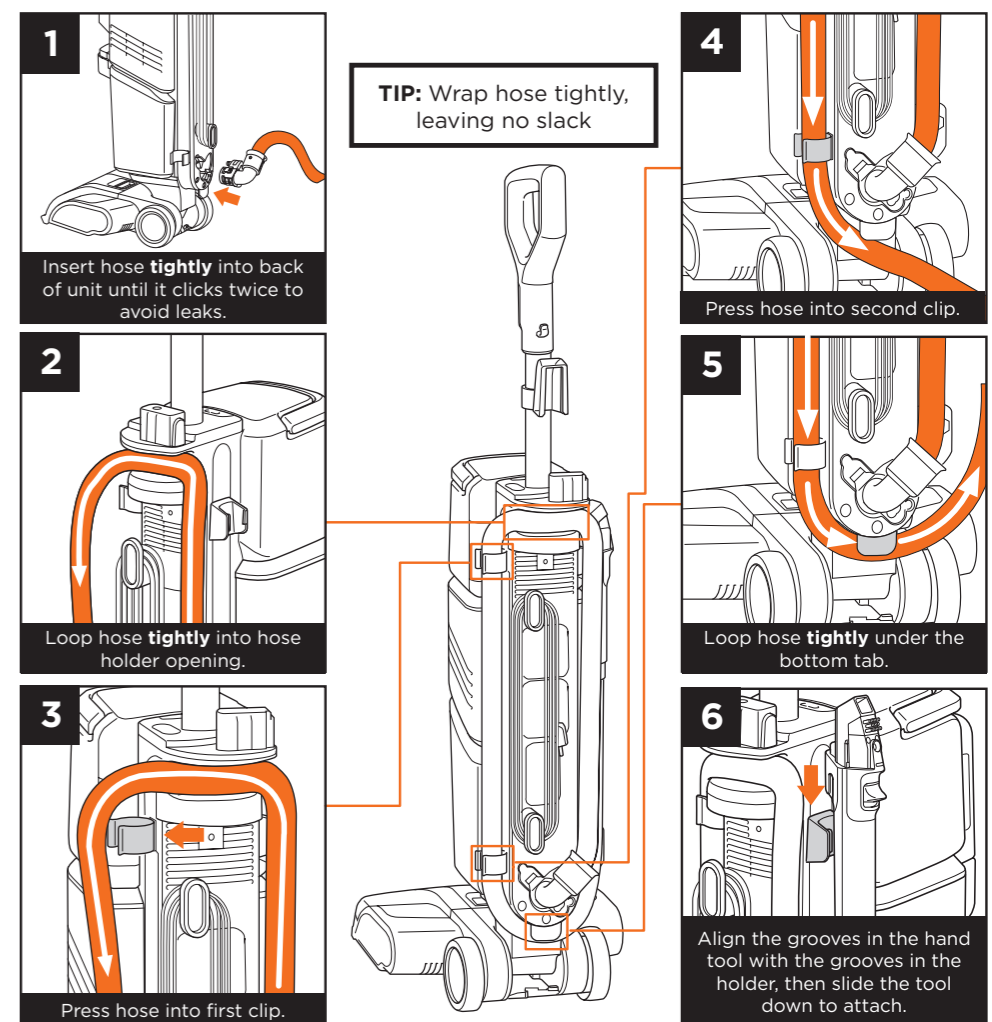

SHARK® SOLUTIONS AND TANKS

The CarpetXpert™ tanks are designed to work with Shark cleaning solutions. To order refills, scan the QR code located on the bottom of the CarpetXpert Tank. Do not use third party or homemade cleaners.

- **Shark Deep Clean Pro** For deep-cleaning carpets with the brushroll.
- **Shark OXY Multiplier**: Dispensed from the StainStriker tank. Combines with Deep Clean Pro from the CarpetXpert Tank to be used at the hand tool for stain cleaning.

Filling the CarpetXpert Tank (top clear tank)

1. Lift the CarpetXpert Tank by the handle to detach it, then remove the cap.
2. Add warm water to the tank up to the WATER fill line. Do not use water hotter than 140°F (60°C).
3. Add Shark Deep Clean Pro up to the CONCENTRATE fill line.
4. Reattach cap, then reinstall the CarpetXpert Tank.



Filling the StainStriker Tank (smaller, blue tank)

1. Lift the StainStriker Tank by its sides to detach it, then remove the cap.
2. Add Shark OXY Multiplier up to the MAX FILL line.
3. Reattach cap, then reinstall the StainStriker tank.

CLEANING WITH CARPETXPRT

DEEP CLEANING with the brushroll:
Uses Deep Clean Pro Formula and water

Important: Vacuum with traditional vacuum cleaner first, especially pet hair. CarpetXpert is not designed for dry vacuuming.

1. Move the selector lever to UP position to use brushroll.
2. Gently step on the base and tilt the handle back.
3. Press power button; unit will enter Deep Clean Mode.
4. Move unit forward; it will automatically dispense water and Deep Clean Pro formula.
5. Move back to dry with suction only (does not dispense fluid on back stroke).
6. Repeat steps 4 and 5 on the same area once.

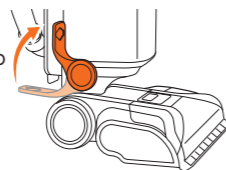

QUICK DRY MODE

Avoid over-cleaning the same spot in Deep Mode to prevent saturated carpets and long dry times. Drying may take a few hours.

Once deep clean is complete, press the Mode button to activate Quick Dry Mode. Repeated passes in Quick Dry Mode will reduce dry time.

Rinsing: Some users may want to rinse their carpet after cleaning. To do this, fill CarpetXpert Tank with only water, and repeat cleaning steps.

STAIN CLEANING with the hand tool:
Uses Deep Clean Pro Formula + OXY Multiplier

1. With the unit in upright position, unwrap hose, and push the selector lever DOWN until it clicks into place.
2. Suction up any wet mess, then spray the stained area (fig. 1). Scrub the stain with the bristles (fig. 2), then tilt the hand tool up (fig. 3) and drag it across the stained area to extract the mess. Repeat if needed. If stain is dry, first break up the stain with the bristles and suction up.

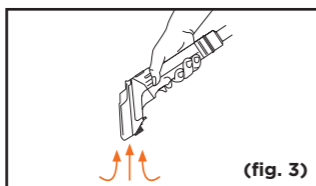
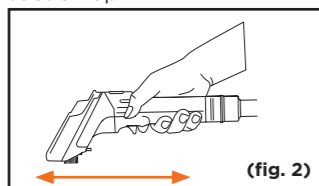
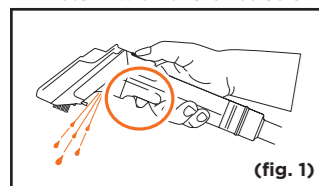
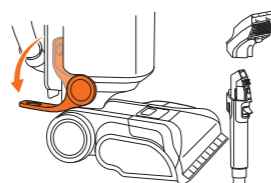

The **3.5" Hand Tool** is for general stain cleaning, while the **Crevice Tool** is intended for tight spaces like corners. The rubber side of the reversible bristles is intended for softer fabrics and only to be used with fluid, not dry. The **7" Hand Tool** (included in some models) is intended for larger areas like sofa cushions or stairs.

The Shark **Pet Tool** is included with select models. The tool extracts wet pet messes, while preventing the mess from reaching the hose and the interior of the unit. Use on wet pet messes only. **DO NOT** use the tool to remove pet hair. To use, first spray the wet mess, then extract it with the Pet Tool. **DO NOT** exceed the **MAX FILL** line on the Pet Tool cup. Keep the tool level, without tipping, to prevent the mess from reaching the hose.

After use, turn off the CarpetXpert power and empty the Pet Tool cup into a toilet. Wash the cup, filter, and the rest of the tool thoroughly with soap and water after every use. To avoid oversaturating, do not overspray.

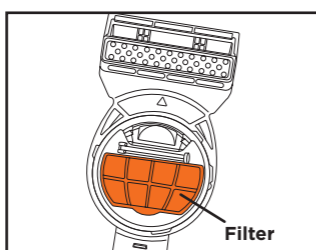
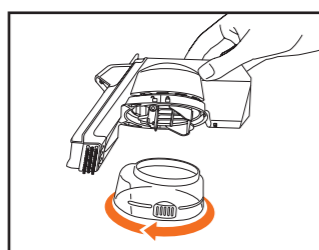
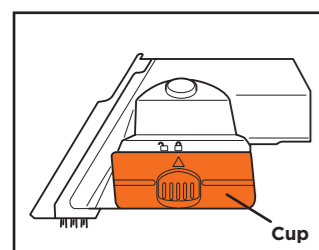

INDICATOR LIGHTS

MODES

Blue (Left): Deep Clean Mode (brushroll at floor nozzle).

Blue (Right): Quick Dry Mode (brushroll at floor nozzle).

Both Green: StainStriker (at hand tool).

NOTIFICATIONS

Red: Brushroll jam. Remove obstruction, then reinstall brushroll.

Flashing Blue: The dirty water tank is full. Empty the tank, then reinstall it.

Flashing Red: Brushroll cover open. Close cover.

Flashing Green: The selector lever is in the wrong position. Move lever UP to clean with brushroll. Move lever DOWN to clean with the hand tool.

MAINTENANCE

Clean unit after every use to avoid odors, bacteria, and mold.

Note: When turning off the power, it may take 2 to 3 seconds for the unit to clear the lines and power down completely.

DIRTY WATER TANK

Note: You will hear a change in motor noise/air flow when the dirty water tank is full.

1. Press the release button and remove the tank.
2. Lift out inner float mechanism. **DO NOT** pour out dirty water until float is removed.
3. Pour dirty water down drain.
4. Remove the filter cover, then lift out the filter. Wash the filter with soap and water, then allow it to air-dry completely before reinstalling.

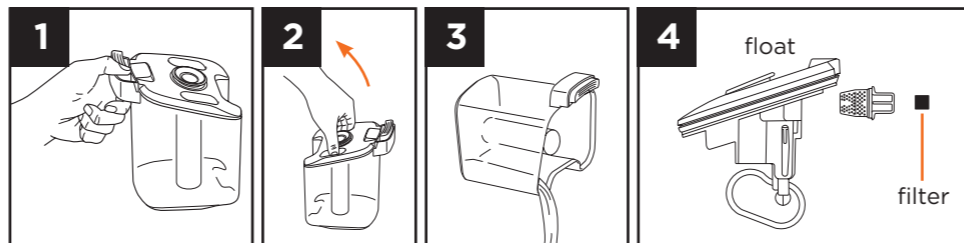

BRUSHROLL

1. Pull latch to remove top brushroll cover.
2. Lift brushroll door to open.
3. Remove the brushroll by pulling up on the side tab. If hair is wrapped, cut it away by running scissors along the groove in the brushroll. Wash brushroll, cover, and doors and allow them to air-dry before reinstalling.
4. To reinstall the top brushroll cover, connect the 2 hooks at the bottom, then push forward until it clicks into place.

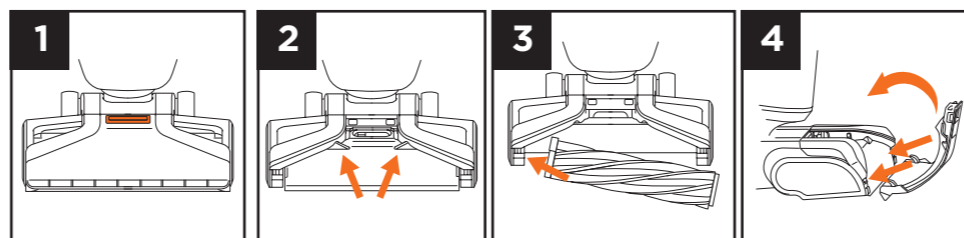

HAND TOOLS

Press the release button to detach tool. Pull tab to remove window and bristle strip. Wash tools with soap and water and allow them to air-dry before reinstalling.

HOSE

Attach the hose-cleaning tool to the end of the crevice tool and turn on power. Point tool to the floor, pull the trigger, and the cleaning solution will be sucked into the hose to clean the interior.

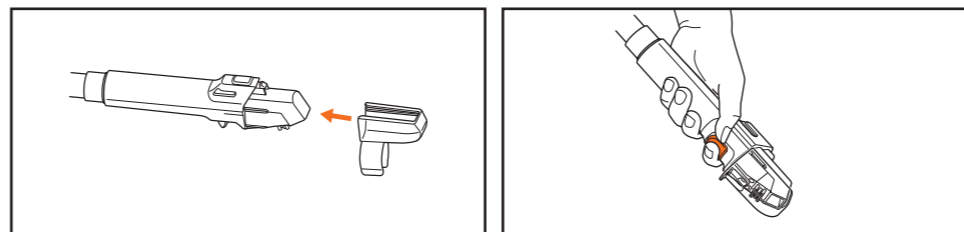

TROUBLESHOOTING

CHECKING FOR DEBRIS

Note: You will hear a change in motor noise/air flow when the dirty water tank is full.

To check airpath for clogs, hair, or debris:

1. Unplug unit.
2. Remove dirty water tank.
3. Remove seal (fig. 7).
4. Detach the hose (fig. 8).
5. Remove the selector lever by pushing it all the way forward (fig. 9), then pulling it out sideways (fig. 10).
6. Remove any debris.
7. Reattach parts.

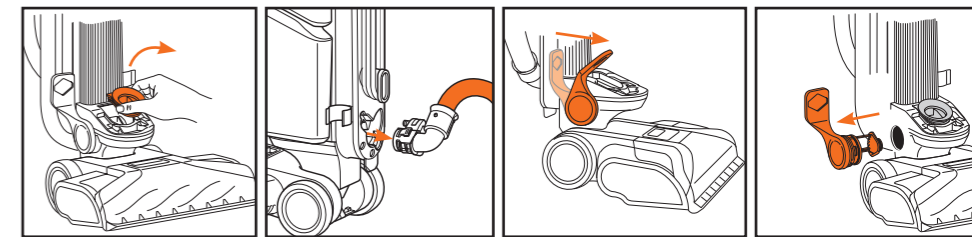

Leaking: Be sure the hose is assembled and connected properly and the caps on the tanks are tightened.

Poor suction: See Checking for Debris section, and be sure hose, dirty water tank, and seal under dirty water tank are all connected properly. Make sure the hose clicks twice when attaching to the body.

Hand tool not spraying: Be sure lever is in down position and tanks are full.

Floor nozzle not dispensing solution: Be sure lever is in the up position and tanks are full.

Oxy Multiplier is not being dispensed: Be sure tanks are attached securely. Note: The StainStriker tank dispenses at a slower rate than the CarpetXpert Tank.

Shark NINJA

FIVE (5) YEAR LIMITED WARRANTY

FIVE (5) YEAR LIMITED WARRANTY

The Five (5) Year Limited Warranty applies to purchases made from authorized retailers of SharkNinja Operating LLC. Warranty coverage applies to the original owner and to the original product only and is not transferable.

SharkNinja warrants that the unit shall be free from defects in material and workmanship for a period of Five (5) year from the date of purchase when it is used under normal household conditions and maintained according to the requirements outlined in the Owner's Guide, subject to the following conditions and exclusions:

What is covered by this warranty?

1. The original unit and/or non-wearable parts deemed defective, in Shark Ninja's sole discretion, will be repaired or replaced up to Five (5) year from the original purchase date.
2. In the event a replacement unit is issued, the warranty coverage ends six (6) months following the receipt date of the replacement unit or the remainder of the existing warranty, whichever is later. SharkNinja reserves the right to replace the unit with one of equal or greater value.

What is not covered by this warranty?

1. Normal wear and tear of wearable parts (such as Shark Cleaner, Pad, etc.), which require regular maintenance and/or replacement to ensure the proper functioning of your unit, are not covered by this warranty. Replacement parts are available for purchase at sharkaccessories.com.
2. Any unit that has been tampered with or used for commercial purposes.
3. Damage caused by misuse, abuse, negligent handling, failure to perform required maintenance, or damage due to mishandling in transit.
4. Consequential and incidental damages.
5. Defects caused by repair persons not authorized by SharkNinja. These defects include damages caused in the process of shipping, altering, or repairing the SharkNinja product (or any of its parts) when the repair is performed by a repair person not authorized by SharkNinja.
6. Products purchased, used, or operated outside North America.

How to get service

If your appliance fails to operate properly while in use under normal household conditions within the warranty period, visit sharkclean.com/support for product care and maintenance self help. Our Customer Service Specialists are also available at **1-800-798-7398** to assist with product support and warranty service options, including the possibility of upgrading to our VIP warranty service options for select product categories. So we may better assist you, please register your product online at registryyourshark.com and have the product on hand when you call. SharkNinja will cover the cost for the customer to send in the unit to us for repair or replacement. A fee of \$25.95 (subject to change) will be charged when SharkNinja ships the repaired or replacement unit.

How to initiate a warranty claim

You must call **1-800-798-7398** to initiate a warranty claim. You will need the receipt as proof of purchase. We also ask that you register your product online at registryyourshark.com and have the product on hand when you call, so we may better assist you. A Customer Service Specialist will provide you with return and packing instruction information.

How state law applies

This warranty gives you specific legal rights, and you also may have other rights that vary from state to state. Some states do not permit the exclusion or limitation of incidental or consequential so the above might not apply to you.

This product may be covered by one or more U.S. patents. See sharkninja.com/patents for more information.

Illustrations may differ from actual product. We are constantly striving to improve our products; therefore the specifications contained herein are subject to change without notice.

© 2023 SharkNinja Operating LLC. SHARK is a registered trademark of Shark Ninja Operating LLC. STAINSTRIKER is a trademark of Shark Ninja Operating LLC.