

ASSEMBLY INSTRUCTIONS

**MODEL : KATE
NIGHT STAND**

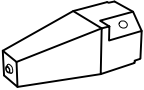

STEP 1 : Pull the top drawer and take out the Bunfoot carton (B). Attach the Bunfoot (B) at the bottom Night Stand (A) used JCBC (1)with Spring Washer (2) Flat Washer (3) and Tighten with Allen Wrench (4).

(Box 1)
BOX OF NIGHT STAND

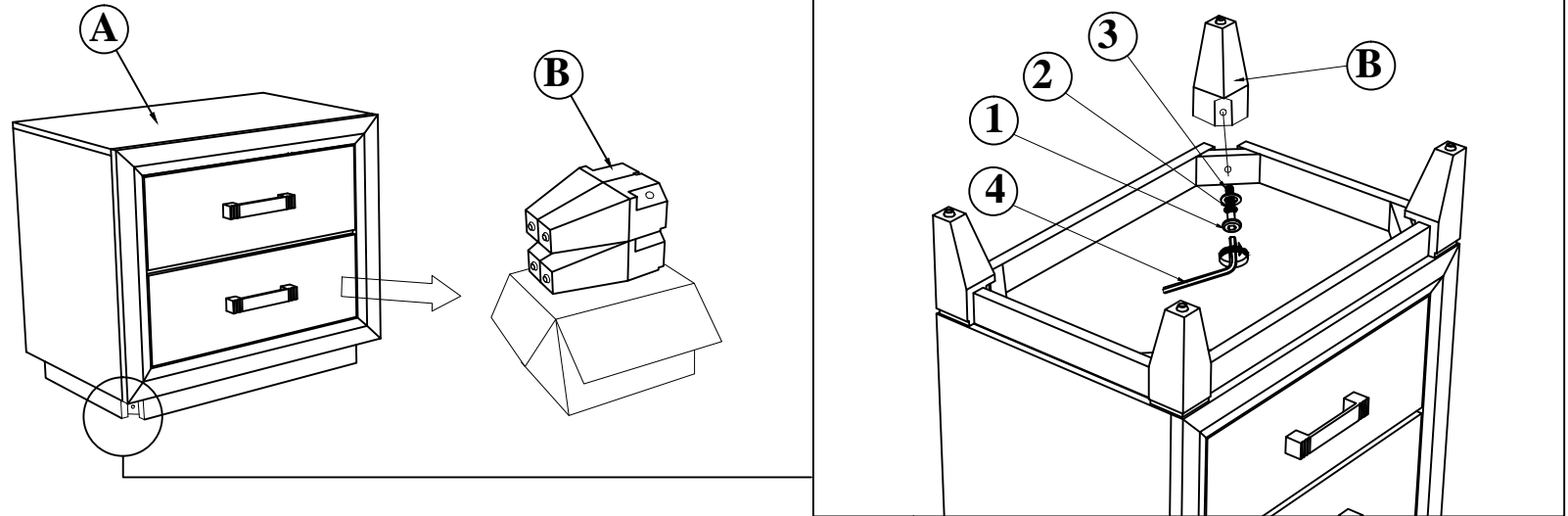
No	ITEM	Qty
A	NIGHT STAND 	1 pc
B	BUN FOOT 	4 pcs

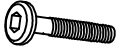

(Box 1)
HARDWARE LIST

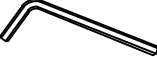
No	ITEM	Qty
1	JCBC M8 x 50mm 	4 pcs
2	SPRING WASHER 5/16" Rbw 	4 pcs
3	Flat Washer 5/16" ID x 22mm OD Blk 	4 pcs
4	ALLEN KEY m5x65mm Blk 	1 pc

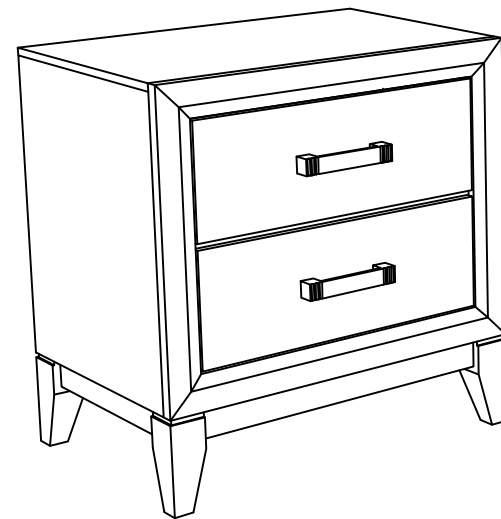

COMPLETED ASSEMBLY

NOTE : MUST TIGHTEN SCREWS **PERIODICALLY** WITH USE SCREW WILL BECOME LOOSE CHECK TIGHTNESS OF ALL SCREW EVERY 6-8 WEEKS.