



# RAZER NAGA V2 PRO

MASTER GUIDE

Designed to dominate in MMO, battle royale, FPS, and more, the multi-genre master returns stronger than ever. With 3 swappable side plates, 19+1 programmable buttons, a Razer HyperScroll Pro Wheel, and Razer HyperSpeed Wireless, the **Razer Naga V2 Pro** packs the power to rise above every genre.

# CONTENTS

1. WHAT'S INSIDE .....	3
2. WHAT'S NEEDED .....	5
3. LET'S GET YOU COVERED .....	5
4. TECHNICAL SPECIFICATIONS.....	6
5. SETTING UP YOUR RAZER NAGA V2 PRO.....	7
6. USING YOUR RAZER NAGA V2 PRO.....	11
7. CONFIGURING YOUR RAZER NAGA V2 PRO VIA RAZER SYNAPSE .....	13
8. SAFETY AND MAINTENANCE .....	35
9. LEGALESE .....	37

---

## 1. WHAT'S INSIDE

- Razer Naga V2 Pro

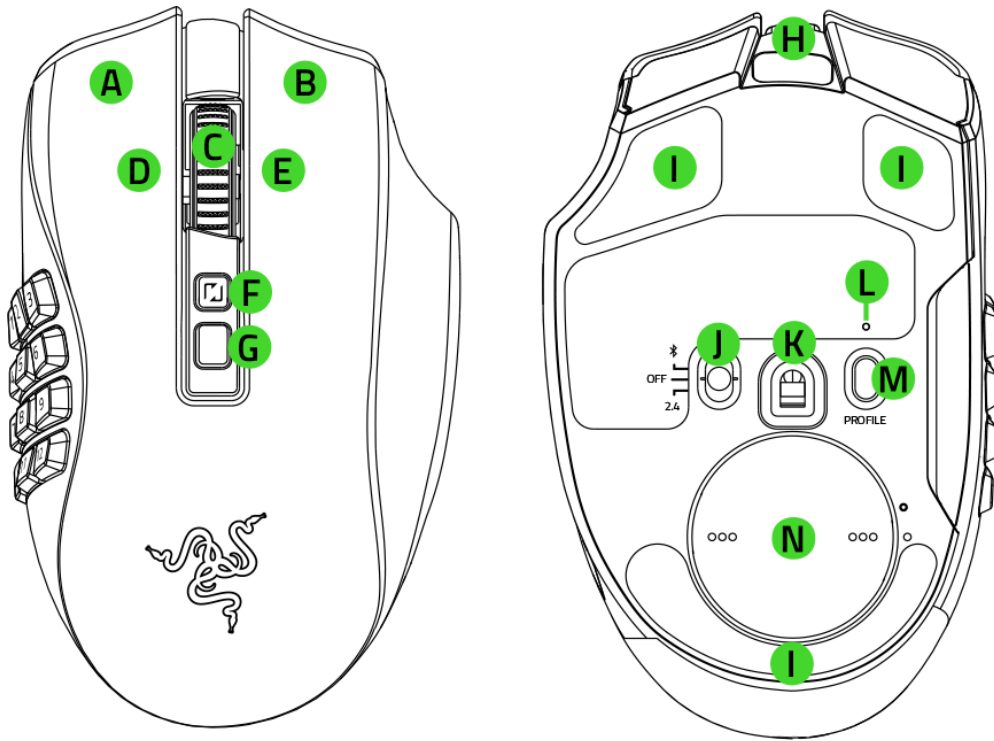

- A.** Left mouse button
- B.** Right mouse button
- C.** Razer™ HyperScroll Pro wheel
- D.** Left tilt-click
- E.** Right tilt-click
- F.** Scroll mode button
- G.** DPI cycle button\*
- H.** USB Type C port
- I.** PTFE mouse feet

- J.** Slider switch
  - Bluetooth mode
  - Power off mode
  - Razer™ HyperSpeed Wireless (2.4 GHz) mode
- K.** Razer Focus Pro 30K Optical Sensor
- L.** Profile indicator
- M.** Profile button
- N.** Cover puck\*\*

*\*The DPI stages are 400, 800, 1600 (default), 3200, and 6400; and can be customized using Razer Synapse.*

*\*\*Interchangeable with the Razer Wireless Charging Puck for wireless charging via Razer Mouse Dock Pro (each sold separately).*

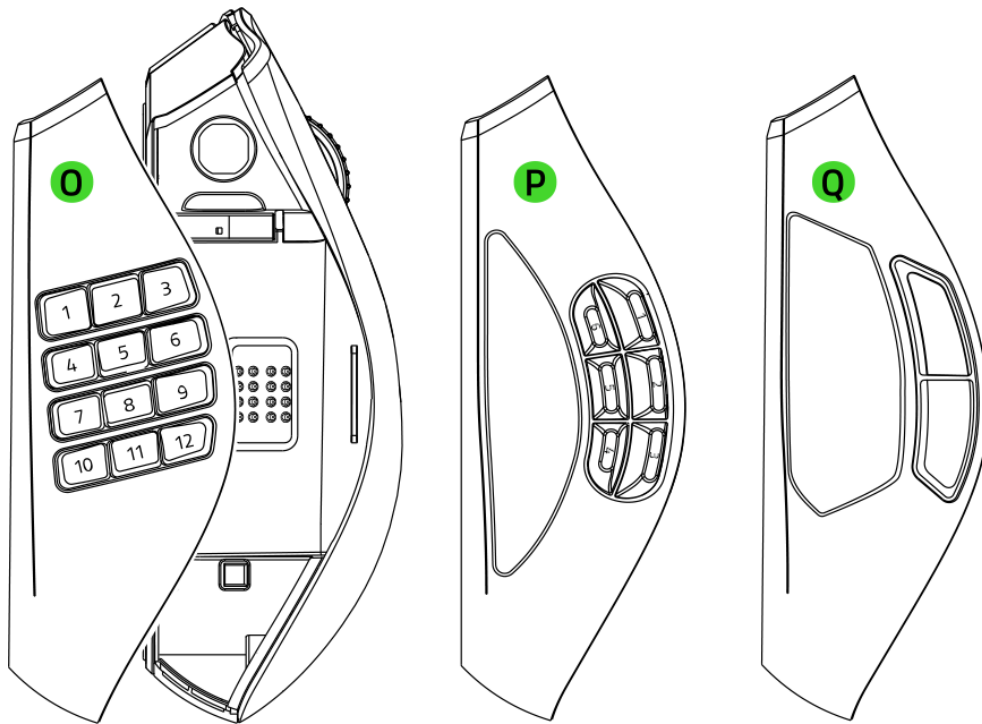

- O. 12-button side plate (recommended for MMOs)
- P. 6-button side plate (recommended for battle royales)
- Q. 2-button side plate (recommended for general use)

- USB Type A to USB Type C Speedflex cable

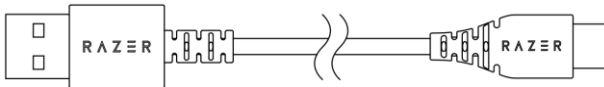

- Razer HyperSpeed Wireless Dongle + USB dongle adapter

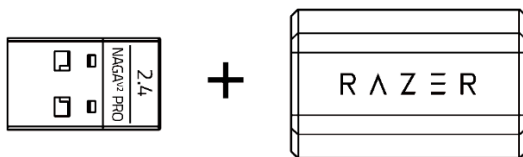

- Important Product Information Guide

---

## 2. WHAT'S NEEDED

### PRODUCT REQUIREMENTS

- USB Type A port or Bluetooth connectivity

### RAZER SYNAPSE REQUIREMENTS

- Windows® 10 64-bit (or higher)
- Internet connection for software installation

---

## 3. LET'S GET YOU COVERED



Register your product and score exclusive benefits

[razerid.razer.com/warranty](https://razerid.razer.com/warranty)

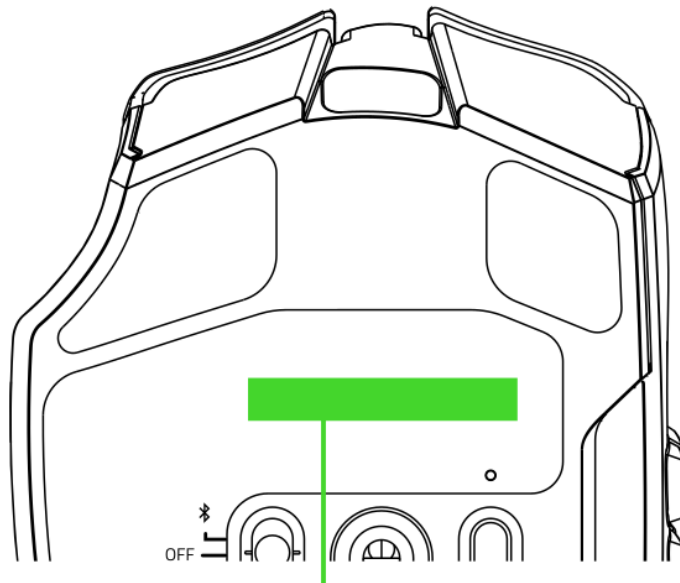

*Your product's serial number  
can be found here.*

---

## 4. TECHNICAL SPECIFICATIONS

- True 30,000 DPI Focus Pro optical sensor with 99.8% resolution accuracy
- Up to 750 inches per second (IPS) / 70 G acceleration
- Advanced Lift-off / Landing distance customization
- 3 modes of connection - HyperSpeed (2.4 GHz), BLE, and wired
- 3 interchangeable side panels with 2, 6, and 12-button configurations
- 100% PTFE mouse feet (0.8 mm thick)
- Ergonomic right-handed design with textured side-grips
- Razer™ Optical Mouse Switches Gen-3 rated for 90 M clicks
- On-The-Fly Sensitivity Adjustment (Default stages: 400/800/1600/3200/6400)
- Advanced on-board memory (4+1 profiles)
- Razer Synapse 3 enabled
- 1.8 m / 6 ft Speedflex cable for charging and wired use
- Razer Mouse Dock Pro and Wireless Charging Puck compatible

---

## 5. SETTING UP YOUR RAZER NAGA V2 PRO

### CHARGING YOUR MOUSE

Plug the charging cable from your PC's USB port into the Razer Naga V2 Pro. For best results, please fully charge the mouse before using it for the first time. A depleted battery will be fully charged in approximately 4 hours.

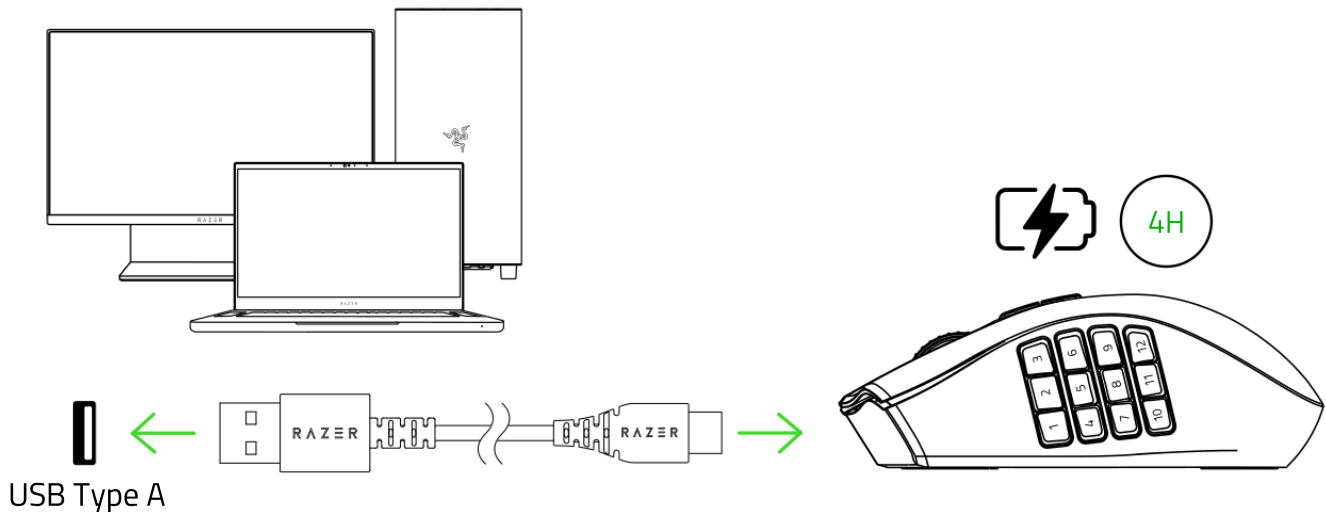

**i** Install Razer Synapse when prompted, or download the installer from [razer.com/synapse](https://razer.com/synapse)

### CONNECTING YOUR MOUSE

#### A. Via wired mode

Connect the mouse to any of your PC's USB ports using the charging cable to use it in wired mode.

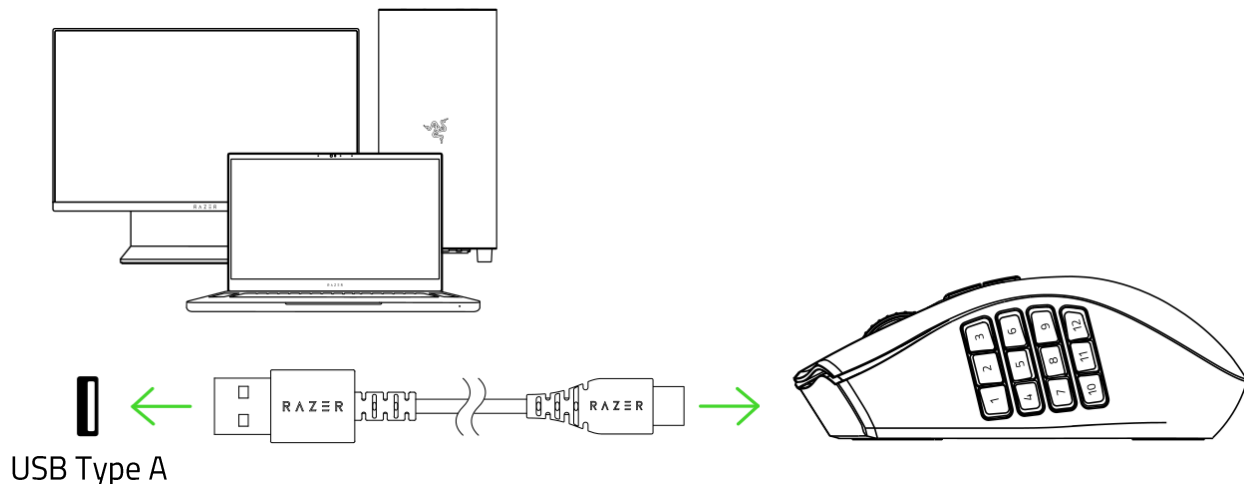



## B. Via Razer™ HyperSpeed Wireless (2.4 GHz) mode

1. Plug the wireless dongle into your PC.

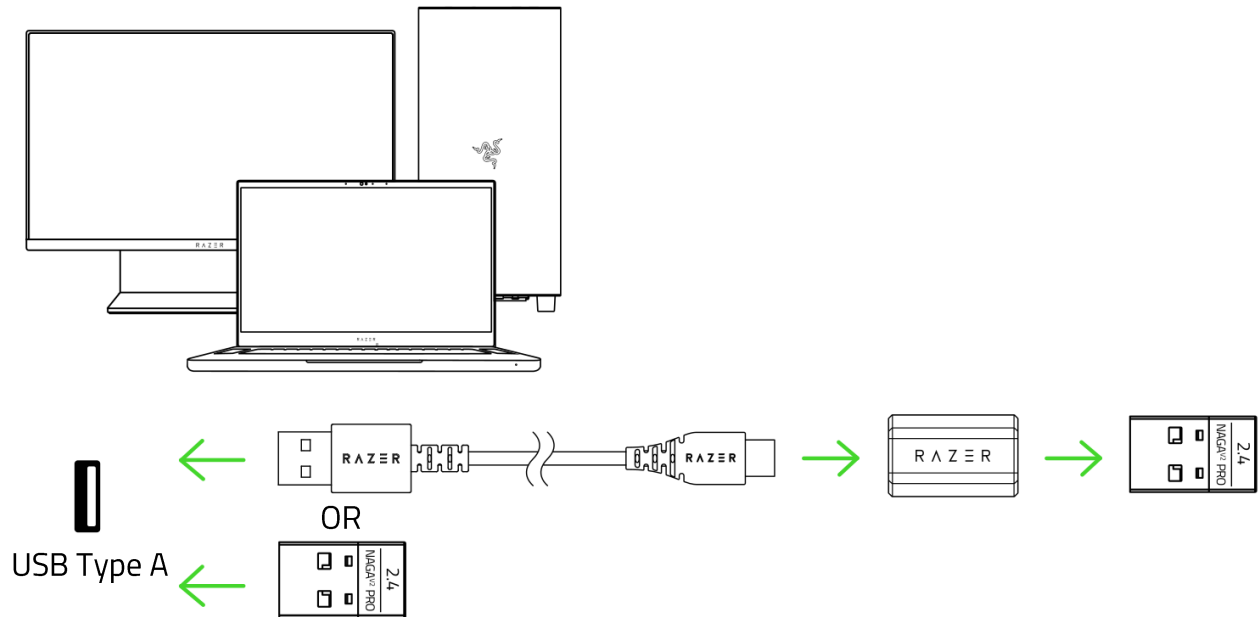

2. Push the slider switch to Razer™ HyperSpeed Wireless (2.4 GHz) mode.

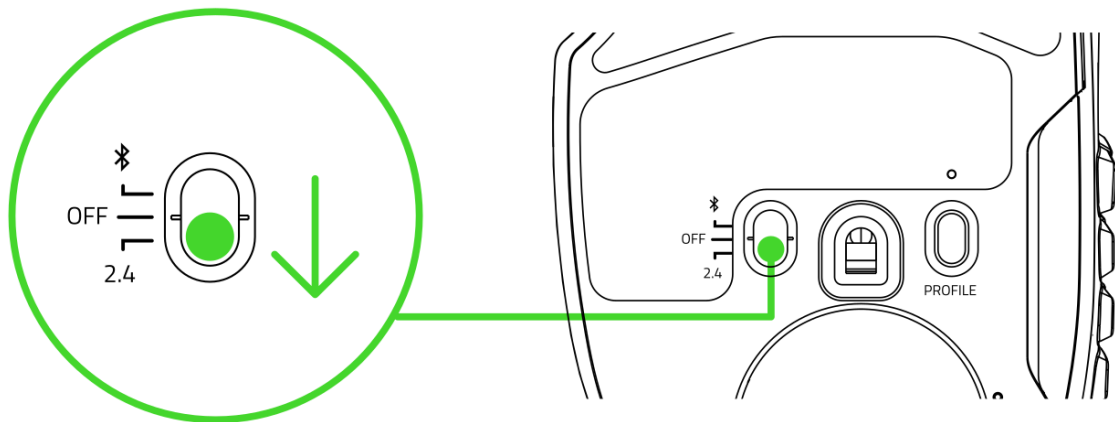

Your Razer Naga V2 Pro is now ready for use in wireless mode.

### C. Via Bluetooth mode

1. Push the slider switch to Bluetooth mode (⌘).

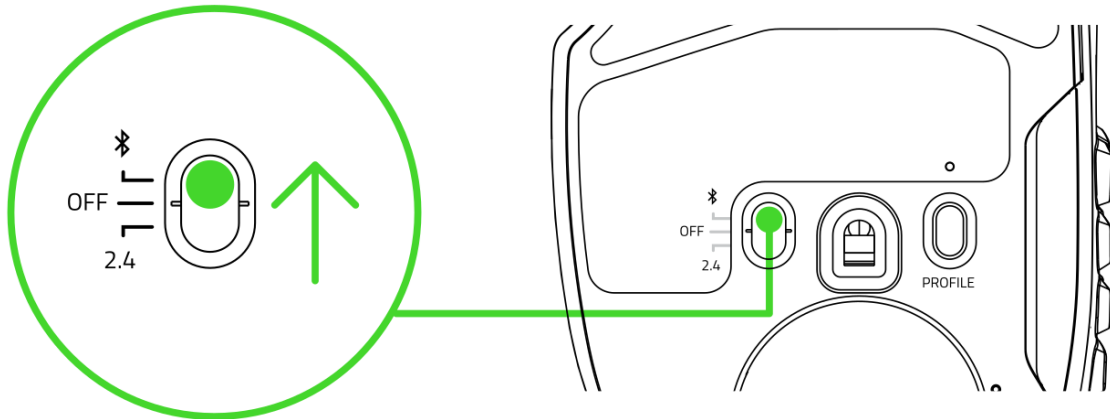

2. Press and hold the scroll wheel, scroll mode, and DPI cycle buttons simultaneously for three seconds to activate pairing mode. The Razer logo will blink twice in repeated intervals to show that the mouse is in pairing mode.

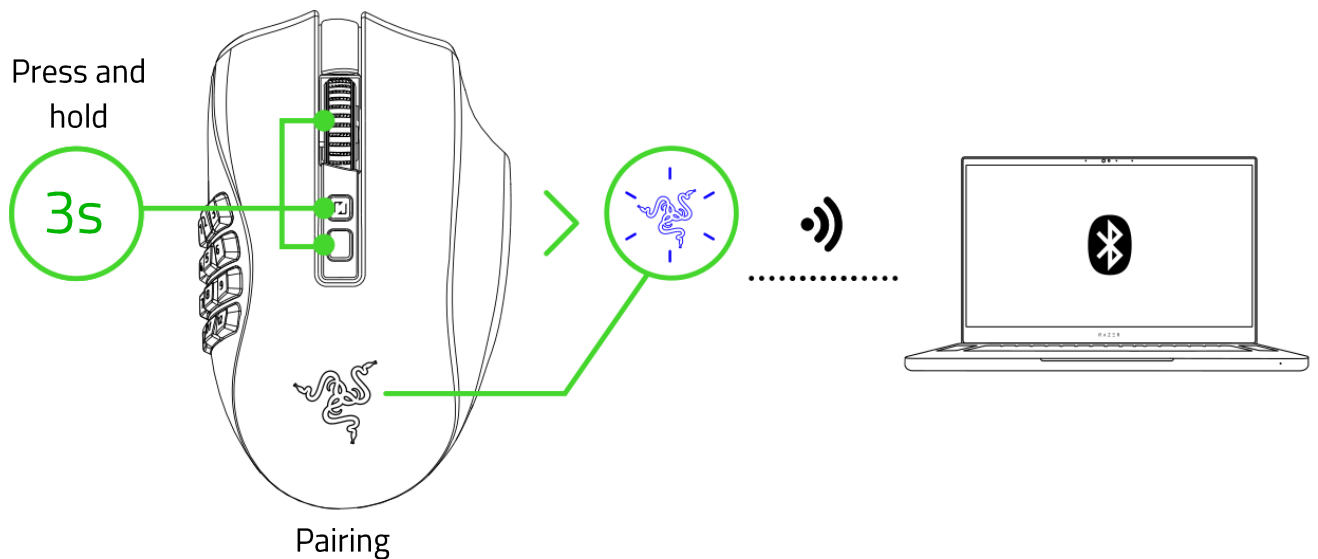

3. Activate Bluetooth on your device and select "**Razer Naga V2 Pro**" from the list of devices found.

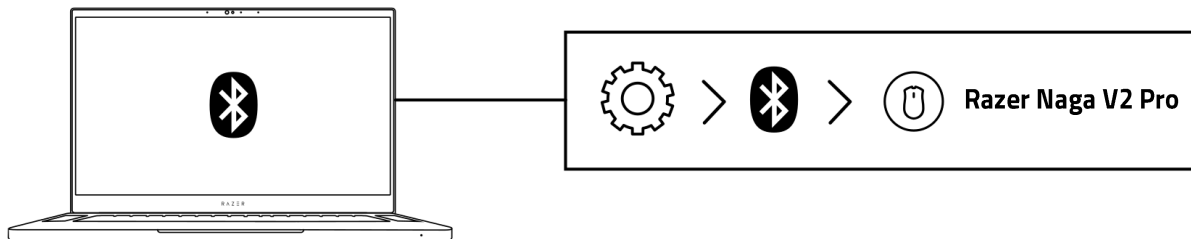

4. Wait until the mouse pairs with your device. The Razer logo will briefly turn static blue when paired.

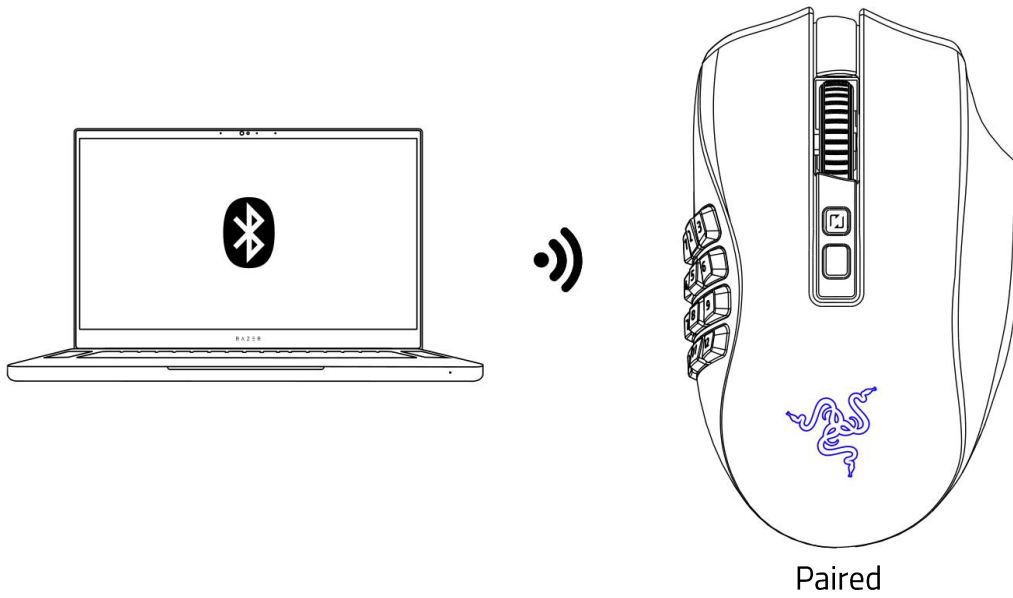

The Razer Naga V2 Pro is now ready for use in Bluetooth mode.

---

## 6. USING YOUR RAZER NAGA V2 PRO

### LOW POWER INDICATOR

The scroll wheel will blink red twice in repeated intervals to indicate that the mouse's battery power is less than 5%. This lighting sequence will repeat until the battery is drained or the mouse is connected to a PC via the charging cable.

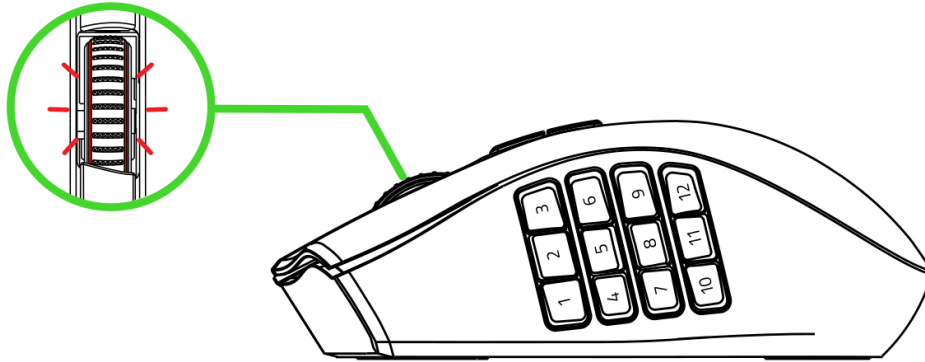

### CHANGING THE SIDE PLATE

Pull from the bottom of the side plate to remove and replace it with the preferred side plate.

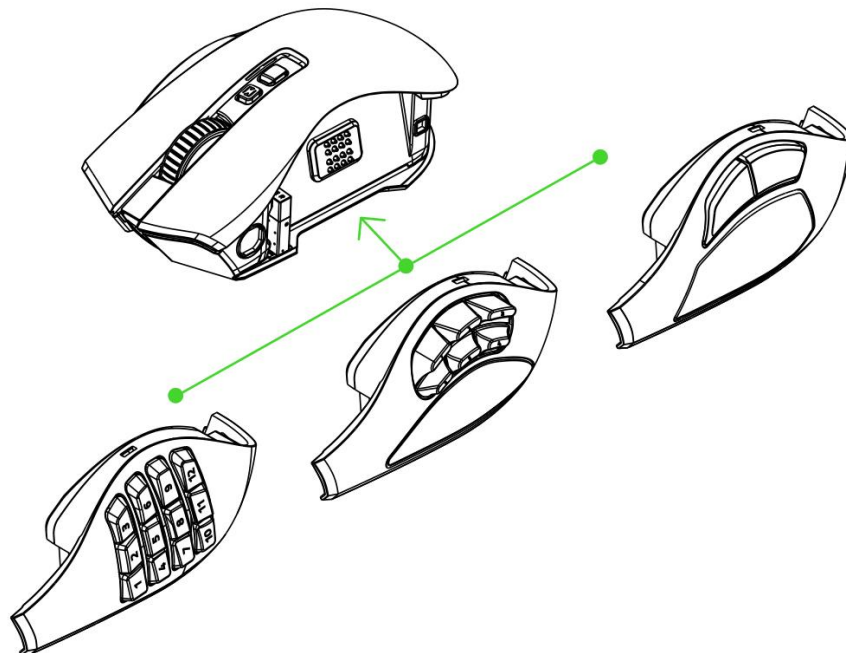

**i** *Unplug the mouse before changing a side plate. These side plates are exclusively designed for the Razer Naga V2 Pro. Don't use side plates designed for other Razer products and vice versa.*

## PERSONALIZING YOUR MOUSE

Your Razer Naga V2 Pro can store up to 5 profiles from the Razer Synapse app, allowing you to use these profiles even on systems without the app installed. Pressing the profile button will cycle through the different profiles, with the profile indicator's color showing which profile is currently selected. [Learn more about Stored profiles](#)

Profile	Designated color
Active Profile	White
Profile 1	Red
Profile 2	Green
Profile 3	Blue
Profile 4	Cyan

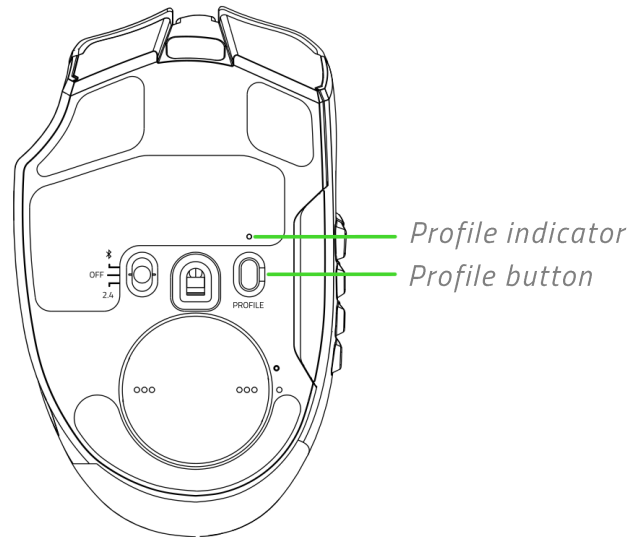

## SWITCHING SCROLL MODES

The scroll mode button allows you to control how you want to scroll through content using the Razer™ HyperScroll Pro Wheel. Press the scroll mode button to cycle through the following scroll wheel stages: Standard (default), Distinct, Ultra-fine, Adaptive, Smooth Scroll, and Custom\*. [Learn more about Scroll Wheel Stages](#)

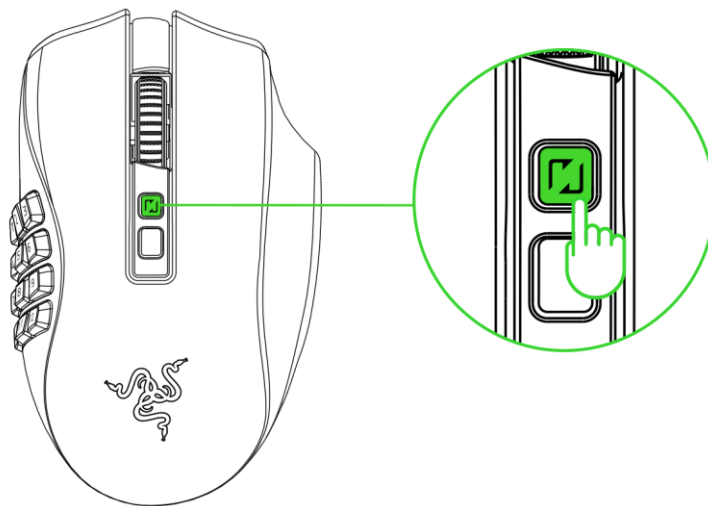

*\*Custom stage is only available when enabled on Razer Synapse. Use the Razer Synapse app to toggle which scroll modes are available, reorder scroll wheel stages, or customize your own.*

---

## 7. CONFIGURING YOUR RAZER NAGA V2 PRO VIA RAZER SYNAPSE

**i** *Internet connection is required for installation, updates, and cloud-based features. Registering for a Razer ID account is recommended but optional. All listed features are subject to change based on the current software version, the connected device(s), and supported apps and software.*

### SYNAPSE TAB

The Synapse tab is your default tab when you first launch Razer Synapse. This tab allows you to navigate the Dashboard subtab.

### Dashboard

The Dashboard subtab is an overview of your Razer Synapse, where you can access all your Razer devices, modules, and online services.

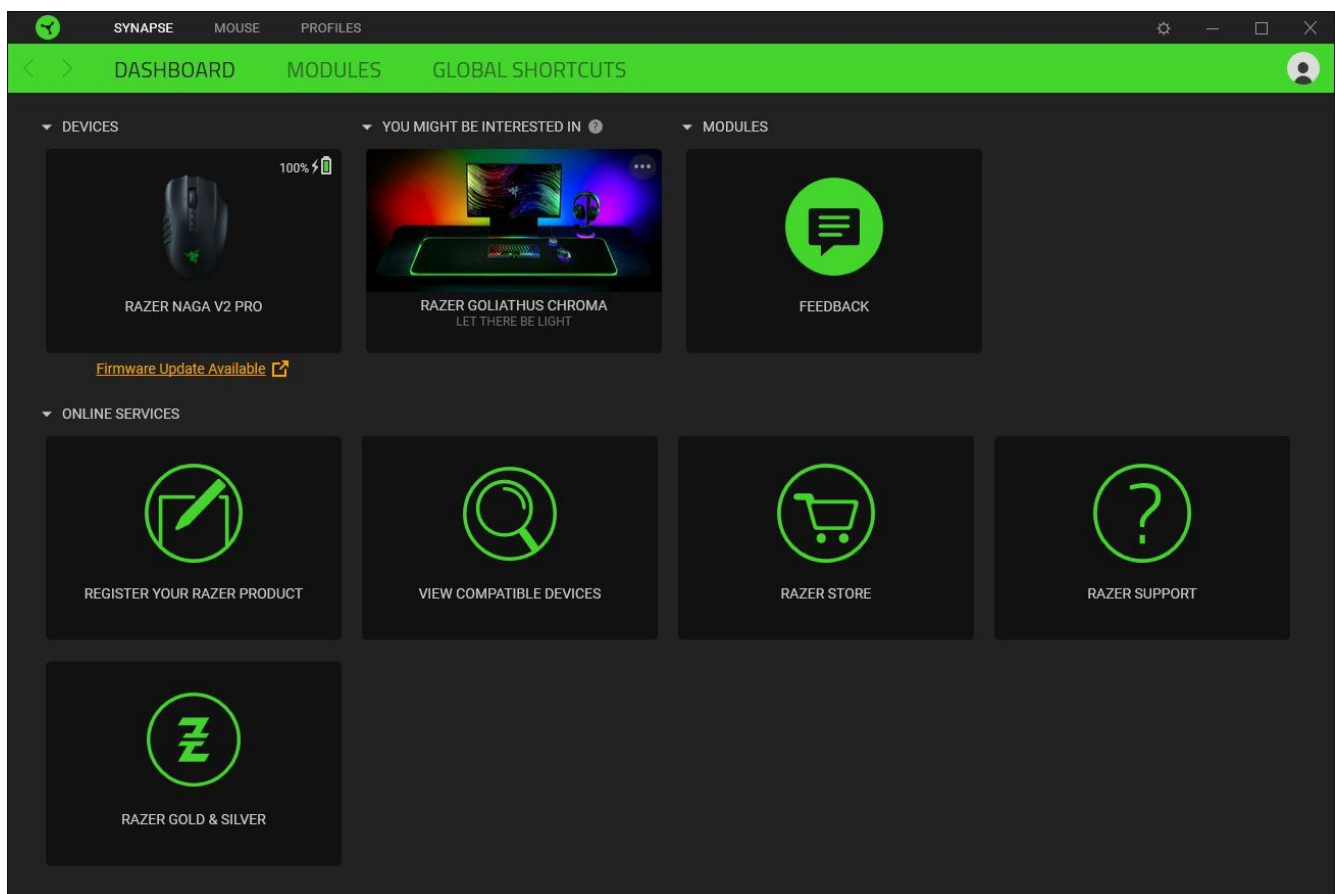

## Modules

The Modules subtab displays all installed and available modules for installation.

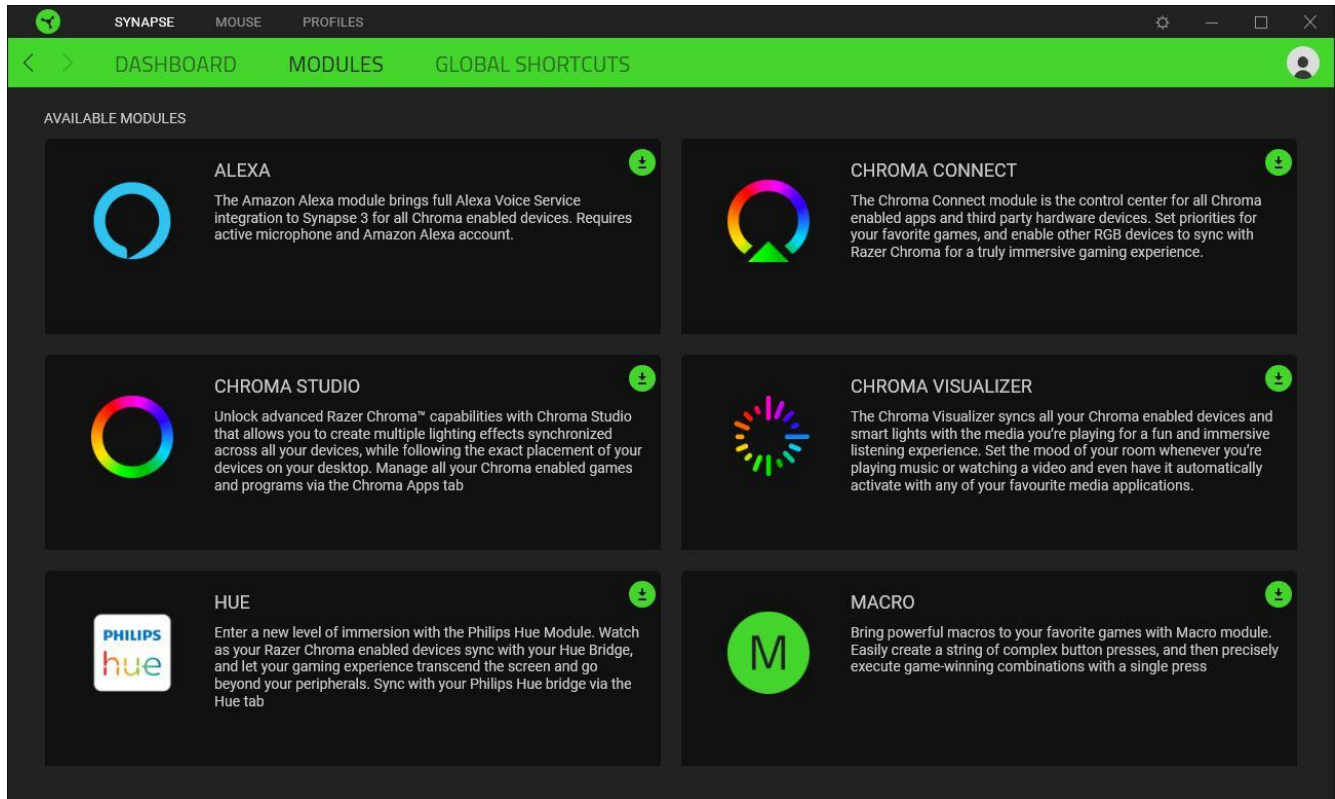

## Global Shortcuts

Bind operations or Razer Synapse functions to custom key combinations from any Razer Synapse-enabled device inputs, which apply across all device profiles. [Learn more about Profiles](#)

**!** *Only Razer Synapse-enabled device inputs will be recognized.*

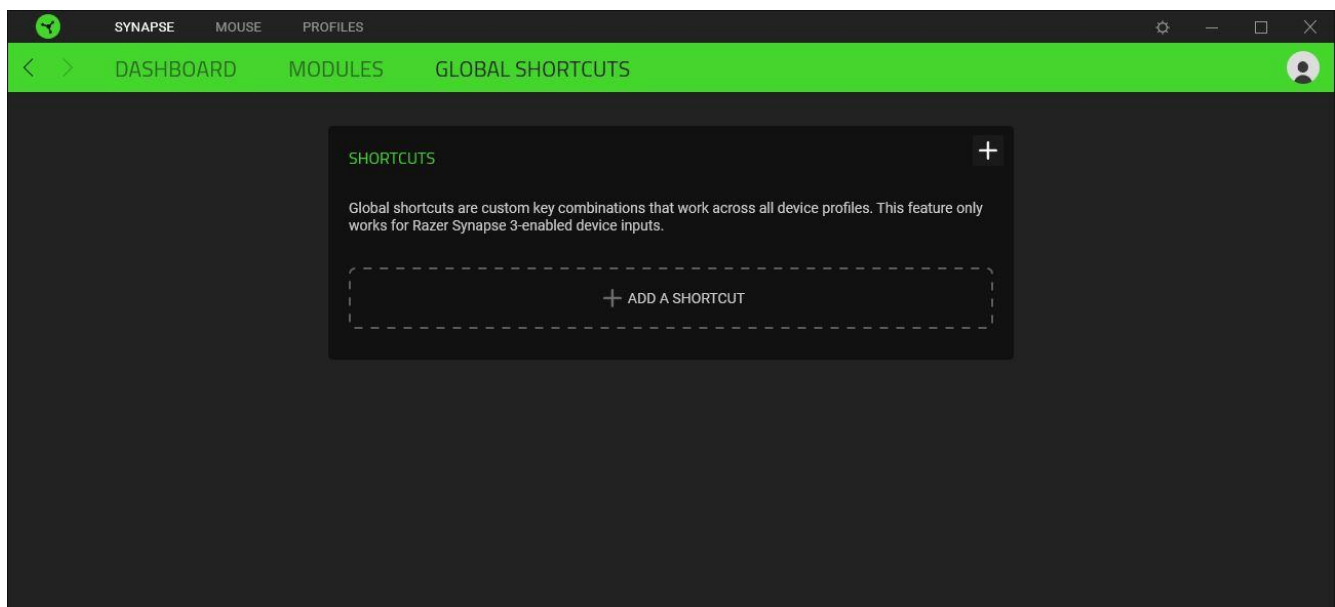

## MOUSE TAB

The Mouse tab is the main tab for your Razer Naga V2 Pro. From here, you can change your device's settings, such as button assignment, DPI sensitivity, scroll wheel stages, and lighting. Changes made under this tab are automatically saved to your system and cloud storage.

### Customize

The Customize subtab is for modifying your mouse's button assignments.

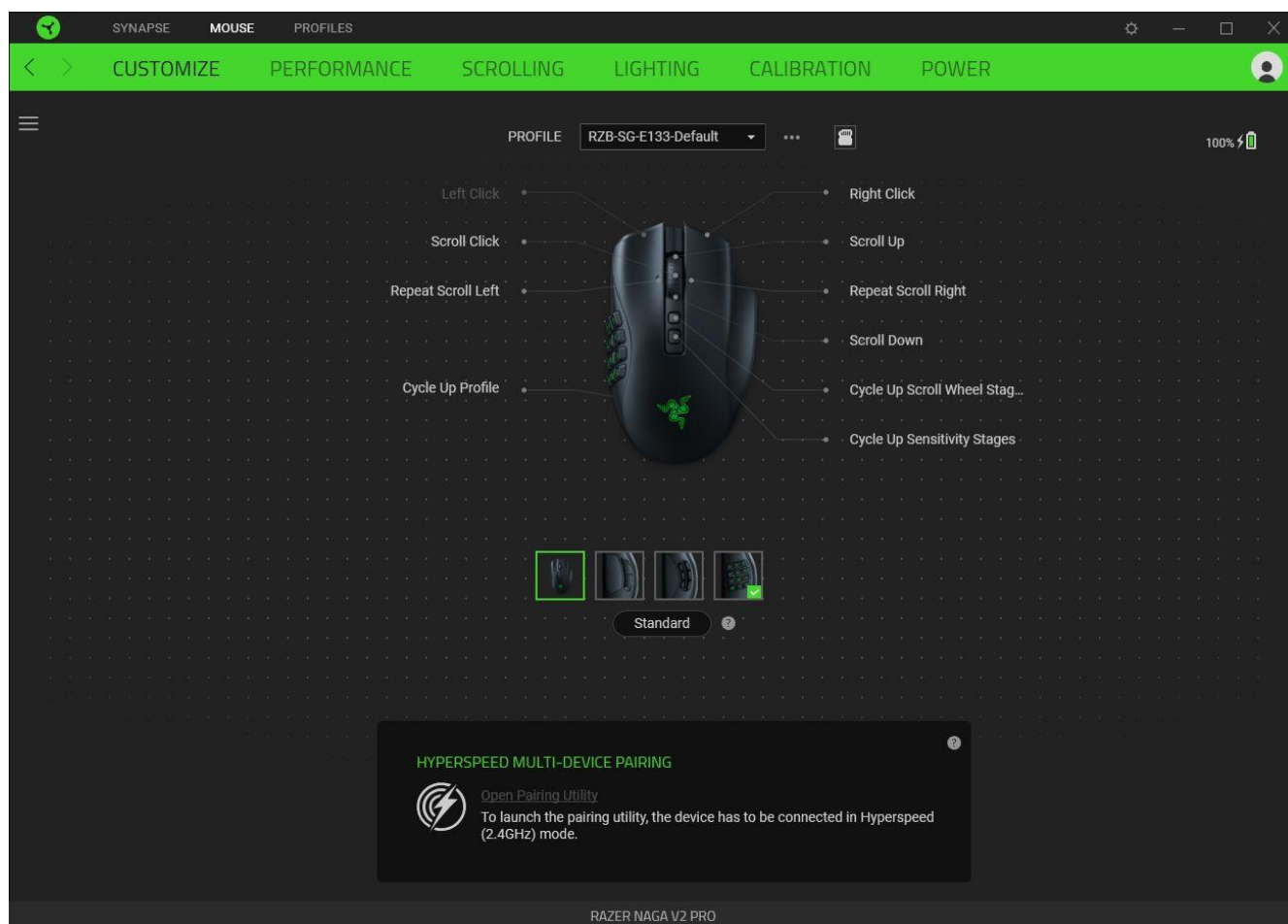

### Profile

Profile is a data storage for keeping all your Razer peripheral's settings. By default, the profile name is based on your system's name. To add, rename, duplicate, or delete a profile, press the Miscellaneous button (●●●).

### Standard / Hypershift

Hypershift mode is a secondary set of button assignments activated when the Hypershift key is held down. By default, the Hypershift key is assigned to the fn key of your Razer Synapse-supported keyboard. However, you can also set any mouse button as a Hypershift key.



## HyperSpeed Multi-Device Pairing

Use this feature to pair an additional HyperSpeed-compatible device with the Razer HyperSpeed Wireless Dongle of your Razer Naga V2 Pro. As its wireless dongle can support a keyboard and mouse simultaneously, you'll be able to remove the usage of separate dongles for each peripheral.

 To use this feature, your Razer Naga V2 Pro must be connected via HyperSpeed (2.4 GHz) Wireless mode. Each peripheral can only connect to one dongle at a time.

## Stored Profiles

Your Razer Naga V2 Pro can store up to 5 profiles from the Razer Synapse app, allowing you to use these profiles even on systems without the app installed. To assign a profile to any available on-board memory slots, click the On-board Profiles button () and drag the profile you want to assign to the preferred memory slot.

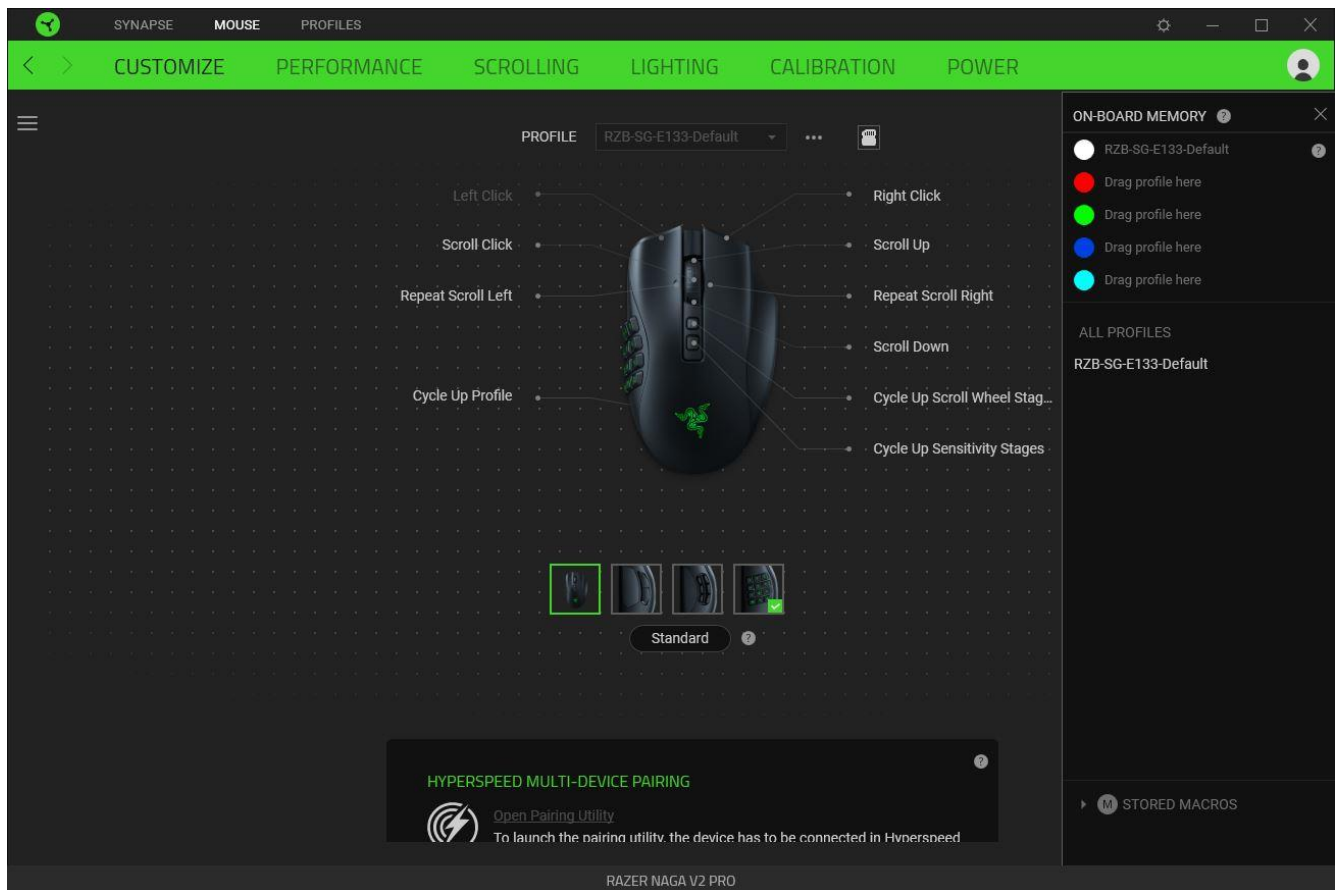

## Sidebar

Clicking the Sidebar button (☰) will reveal all current button assignments for your Razer Naga V2 Pro.

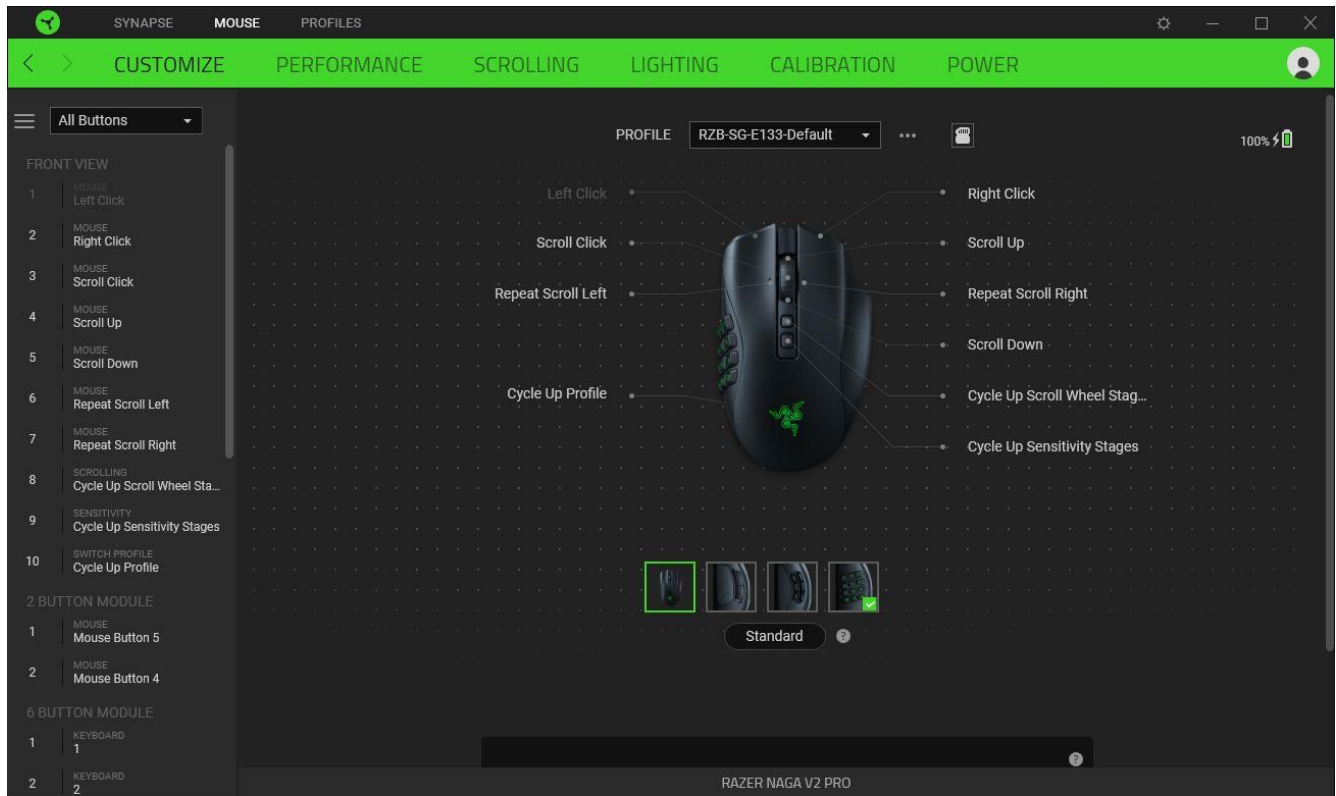

Alternatively, you can skip to a specific button assignment by selecting it on the Customize tab.

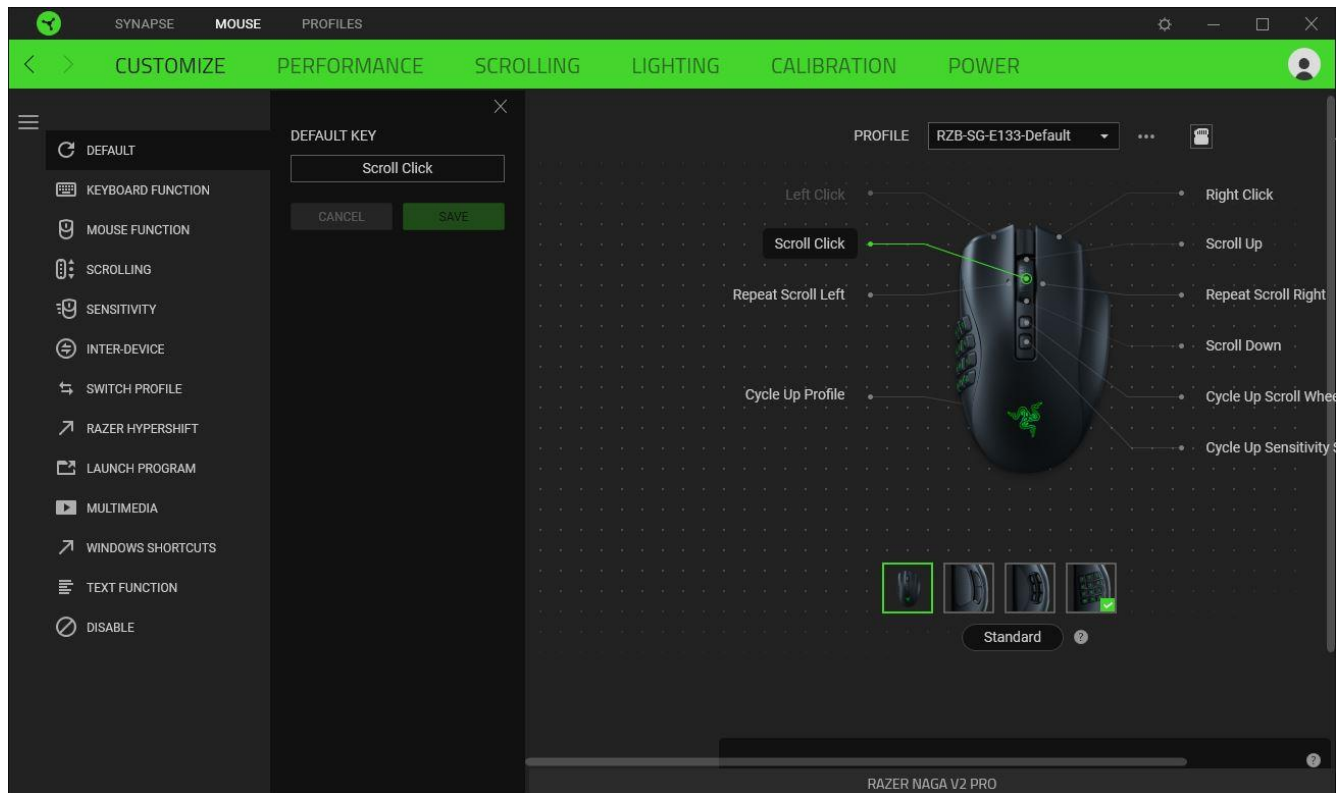

Upon selecting a button assignment, you may then change it to one of the following functions:

### Default

This option enables you to return the mouse button to its original setting.

### Keyboard Function

This option changes the button assignment into a keyboard function. You can also enable Turbo mode, which allows you to emulate a repeated keyboard function while the button is held down.

### Mouse Function

This option substitutes the current button assignment for another mouse function. Listed below are the functions which you can choose from:

- Left Click - Performs a left mouse click using the assigned button.
- Right Click - Performs a right mouse click using the assigned button.
- Scroll Click - Activates the universal scrolling function.
- Double Click - Performs a double left click using the assigned button.
- Mouse Button 4 - Performs a "Backward" command for most internet browsers.
- Mouse Button 5 - Performs a "Forward" command for most internet browsers.
- Scroll Up - Performs a "Scroll Up" command using the assigned button.
- Scroll Down - Performs a "Scroll Down" command using the assigned button.
- Scroll Left - Performs a "Scroll Left" command using the assigned button.
- Scroll Right - Performs a "Scroll Right" command using the assigned button.

You can also choose to enable Turbo mode in some of the mouse functions, which allows you to emulate repeatedly pressing and releasing said function while the button is held down.

### Scrolling

This option allows you to set the button assignment to a cycle up or cycle down scroll wheel stage function. [Learn more about Scroll Wheel Stages](#)

## Sensitivity

This function allows you to manipulate the DPI setting of your Razer Naga V2 Pro with a touch of a button. Listed below are the Sensitivity options and their description:

- Sensitivity Clutch - Changes the sensitivity to a predefined DPI while the designated button is held down. Releasing the button will return it to the previous sensitivity.
- Sensitivity Stage Up - Increases the current sensitivity by one stage.
- Sensitivity Stage Down - Decreases the current sensitivity by one stage.
- On-The-Fly Sensitivity - Pressing the designated button and moving the scroll wheel either up or down will increase or decrease the current DPI.
- Cycle Up Sensitivity Stages - Increases the current sensitivity stage by one. Once it reaches the highest sensitivity stage, it will return to stage 1 when the button is pressed again.
- Cycle Down Sensitivity Stages - Decreases the current sensitivity stage by one. Once it reaches stage 1, it will return to the highest sensitivity stage when the button is pressed again. [Learn more about Sensitivity Stages](#)

## M Macro

A Macro is a prerecorded sequence of keystrokes and button presses that is executed with precise timing. You can conveniently execute a chain of commands by setting the button function to Macro. This function will only be visible when the Macro module is installed.

## Inter-device

Inter-device allows you to change the functionality of other Razer Synapse-enabled devices. Some of these functionalities are device-specific such as using your Razer gaming keyboard to change the Sensitivity Stage of your Razer gaming mouse.

## Switch Profile

Switch Profile lets you quickly change profiles and load a new set of button assignments. An on-screen notification will appear whenever you switch profiles.

## Switch Lighting

Switch Lighting allows you to switch between all advanced lighting effects easily. This function will only be visible when the Chroma Studio module is installed.

## Razer Hypershift

Setting the button to Razer Hypershift will allow you to activate Hypershift mode as long as the button is held down.

## Launch Program

Launch Program lets you open an app or a website using the assigned button. When you select Launch Program, two choices will appear, which require you to search for a specific app you want to open or write the website address you want to visit.

## Multimedia

This option allows you to assign multimedia controls to your Razer device. Listed below are the multimedia controls you can choose from:

- Volume Down - Decreases the audio output.
- Volume Up - Increases the audio output.
- Mute Volume - Mutes the audio.
- Mic Volume Up - Increases the microphone volume.
- Mic Volume Down - Decreases the microphone volume.
- Mute Mic - Mutes the microphone.
- Mute All - Mutes both microphone and audio output.
- Play / Pause - Play, pause, or resume playback of the current media.
- Previous Track - Play the previous media track.
- Next Track - Play the next media track.

## Windows Shortcuts

This option allows you to assign your preferred button to a Windows Operating System shortcut command. For more information, please visit: [support.microsoft.com/kb/126449](https://support.microsoft.com/kb/126449)

## Text Function

Text Function enables you to type a prewritten text with a touch of a button. Write your desired text on the given field, and your text will be typed whenever the assigned button is pressed. This function has full Unicode support, and you can also insert special symbols from character maps.

## Disable

This option renders the assigned button unusable. Use Disable if you do not want to use the selected button or if it interferes with your gaming.

## Performance

The Performance subtab allows you to modify the sensitivity, acceleration, and polling rate.

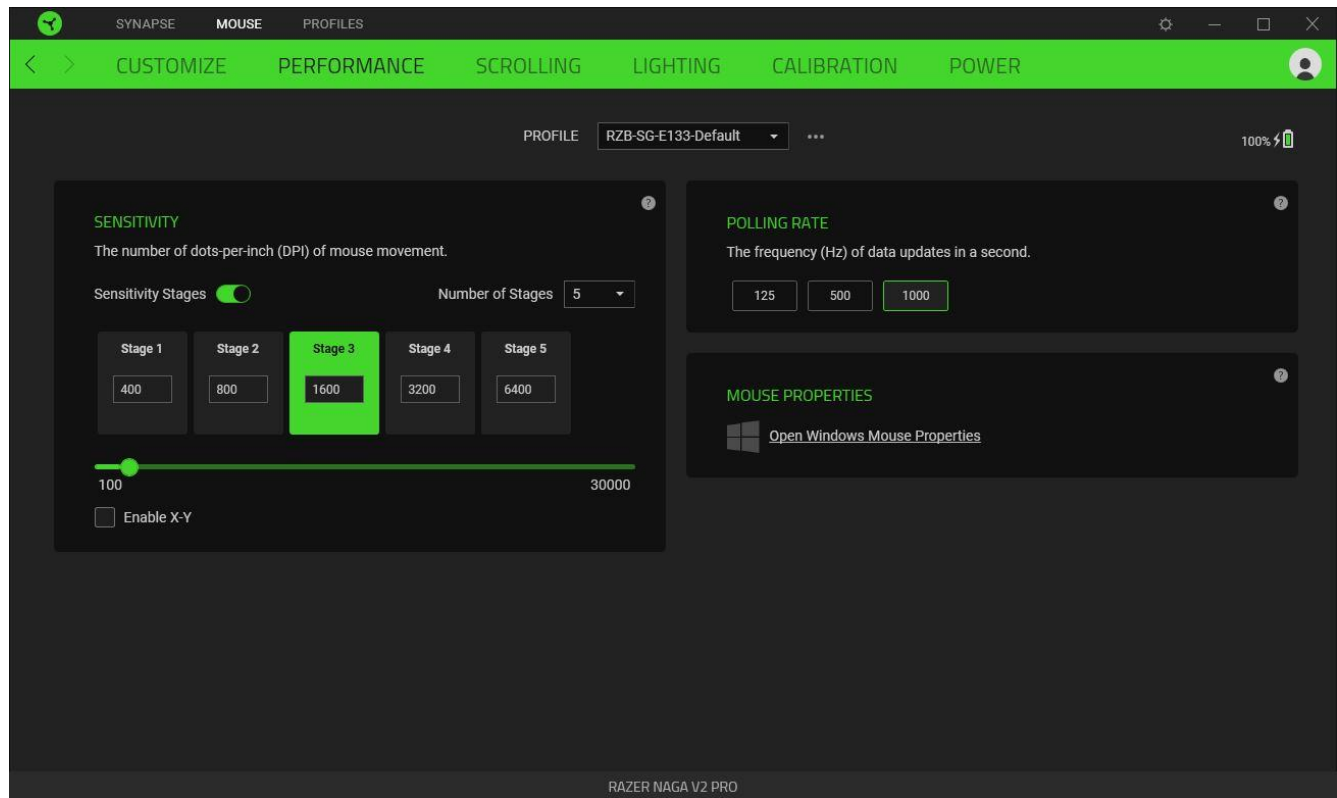

### *Sensitivity*

Sensitivity refers to the distance the cursor will travel based on how far the mouse moves. The higher the DPI, the farther the cursor will travel, given the same mouse movement distance.

### *Sensitivity Stages*

A sensitivity stage is a preset sensitivity value. You can create up to 5 different sensitivity stages, which you can cycle through using the sensitivity stage up/down buttons. You may use the Enable X-Y Sensitivity concurrently with this option.

### *Enable X-Y Sensitivity*

By default, the X-axis (horizontal) and Y-axis (vertical) use the same sensitivity values. However, you may set different sensitivity values for each axis by selecting the Enable X-Y Sensitivity option.

### *Polling Rate*

The higher the polling rate, the more often the computer receives information about the status of your mouse, effectively reducing input latency and improving your mouse pointer's reaction time. You can switch between 125Hz, 500Hz, and 1000Hz by selecting your desired polling rate from the options provided.

### *Mouse Properties*

Allows you to access the Windows Mouse Properties, where you modify operating system settings that can directly affect your Razer Naga V2 Pro.



## Scrolling

Use the Scrolling tab to configure the Razer HyperScroll Pro wheel's advanced features in detail.

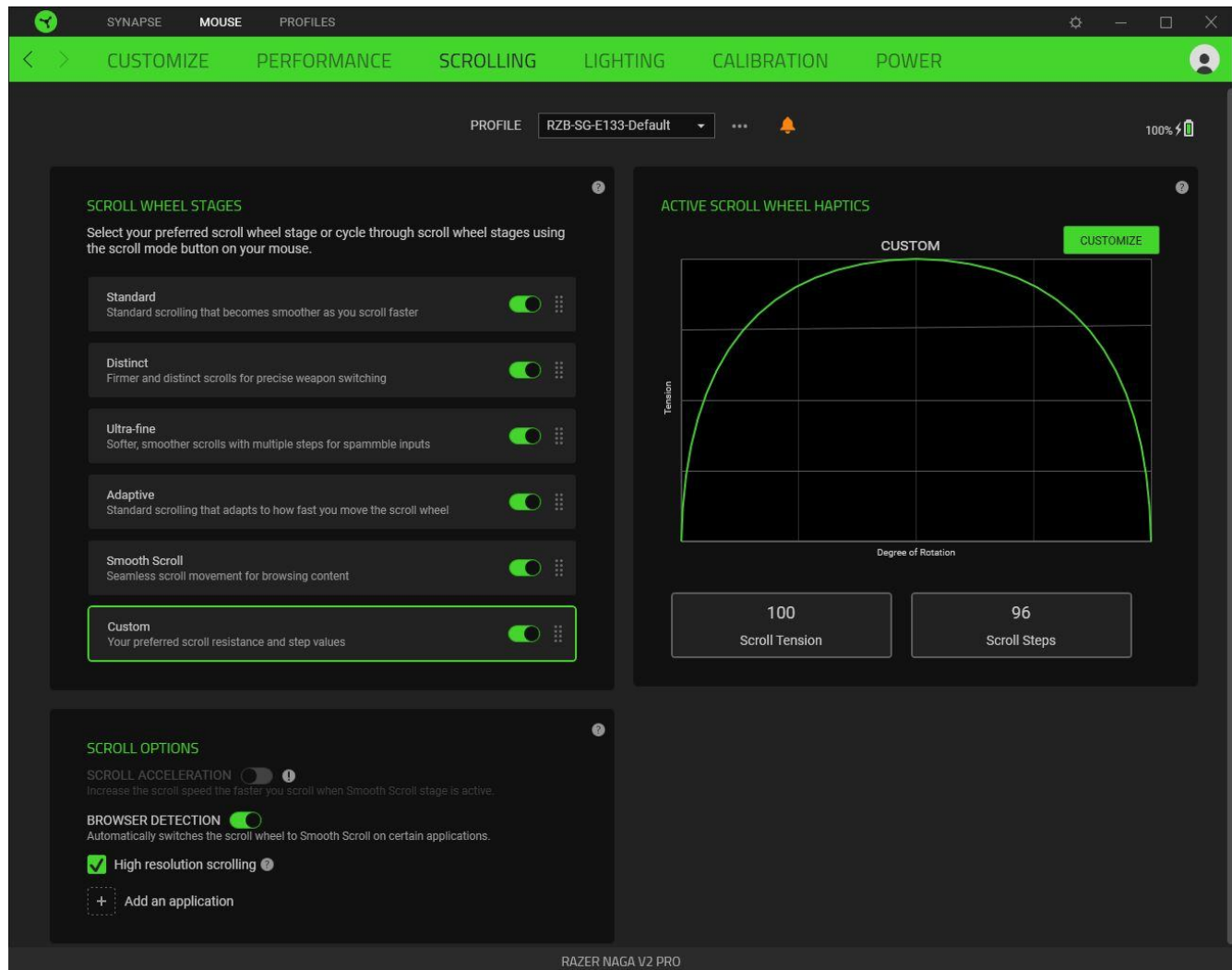

### Scroll wheel stages

Each scroll wheel stage represents a specific scroll mode. Use this section to control which scroll wheel stages are available on the mouse and reorder them to cycle through your preferred scroll modes immediately.

Scroll mode	Description
Standard	Default scroll wheel movement
Distinct	Firmer and distinct scrolls for precise weapon switching
Ultra-fine	Softer, smoother scrolls with multiple steps for spammable inputs

Adaptive	Standard scrolling that adapts to how fast you move the scroll wheel
Smooth Scroll	Seamless scroll movement for browsing content
Custom	Your preferred scroll resistance and step values. This stage is disabled by default

### Creating a Custom stage

To customize your own scroll wheel stage, enable and select the Custom stage and click CUSTOMIZE to input your preferred scroll tension and step.

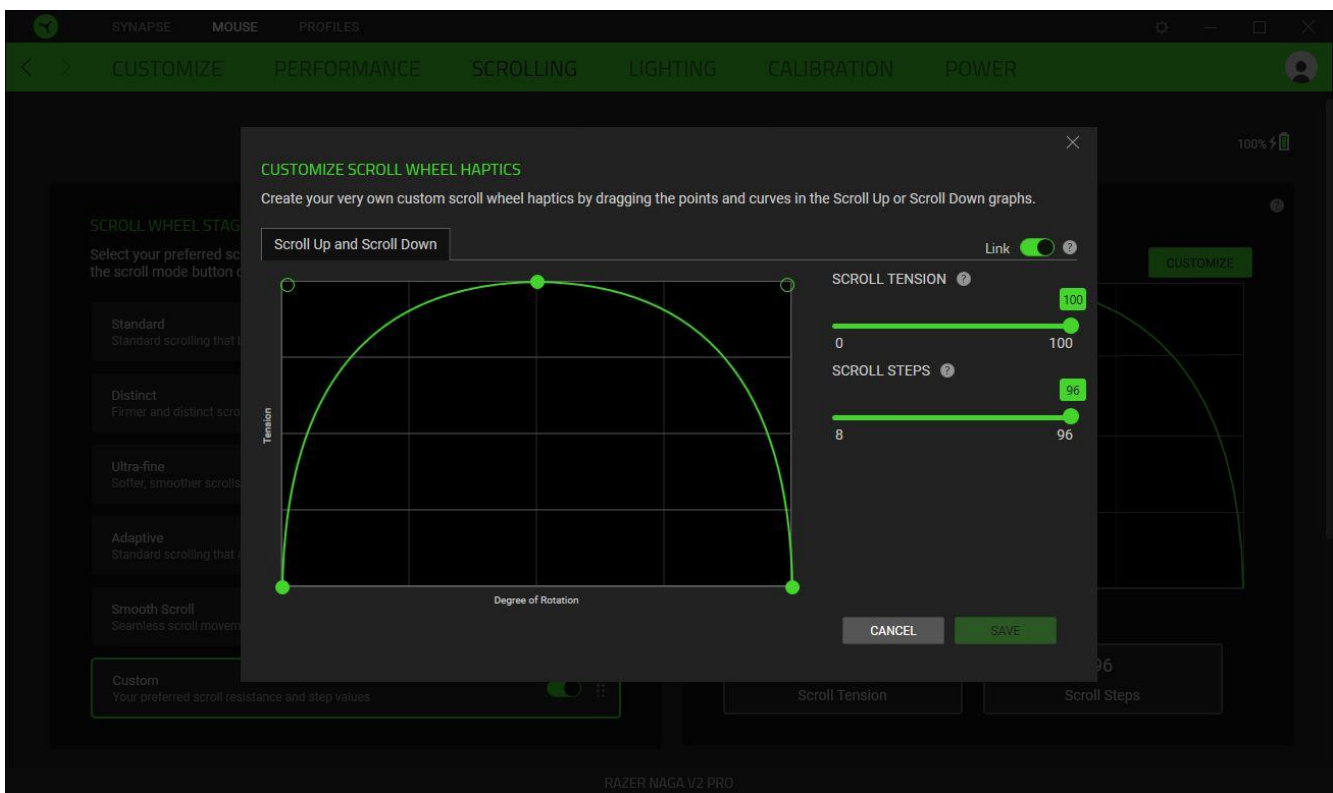

You can modify the scroll up and down haptics by directly tweaking any of the points in the curve or by adjusting the scroll tension and steps slider.

**i** By default, the scroll up and down haptics for the Custom stage use the same scroll tension and steps value. To customize each scroll direction separately, toggle the Link option off.

### Active Scroll Wheel Haptics

The Active Scroll Wheel Haptics section shows how the active stage's resistance increases or decreases as you rotate the scroll wheel.

### *Scroll acceleration*

Available only when Smooth Scroll mode is active, this feature allows Razer Synapse to detect how fast you scroll and virtually amplify the scroll wheel's movement the faster the scroll wheel rotates.

### *Browser detection*

When enabled, the mouse will automatically switch to Smooth Scroll mode when scrolling on certain applications. You can add other applications where Browser detection can take effect using the **Add an application** option.



*When you navigate away from a preset/configured application, the mouse will automatically revert to its previous setting. For an even smoother scrolling experience, it's recommended that you enable the High-resolution scrolling option.*

## Lighting

The Lighting subtab enables you to modify your Razer device's light settings.

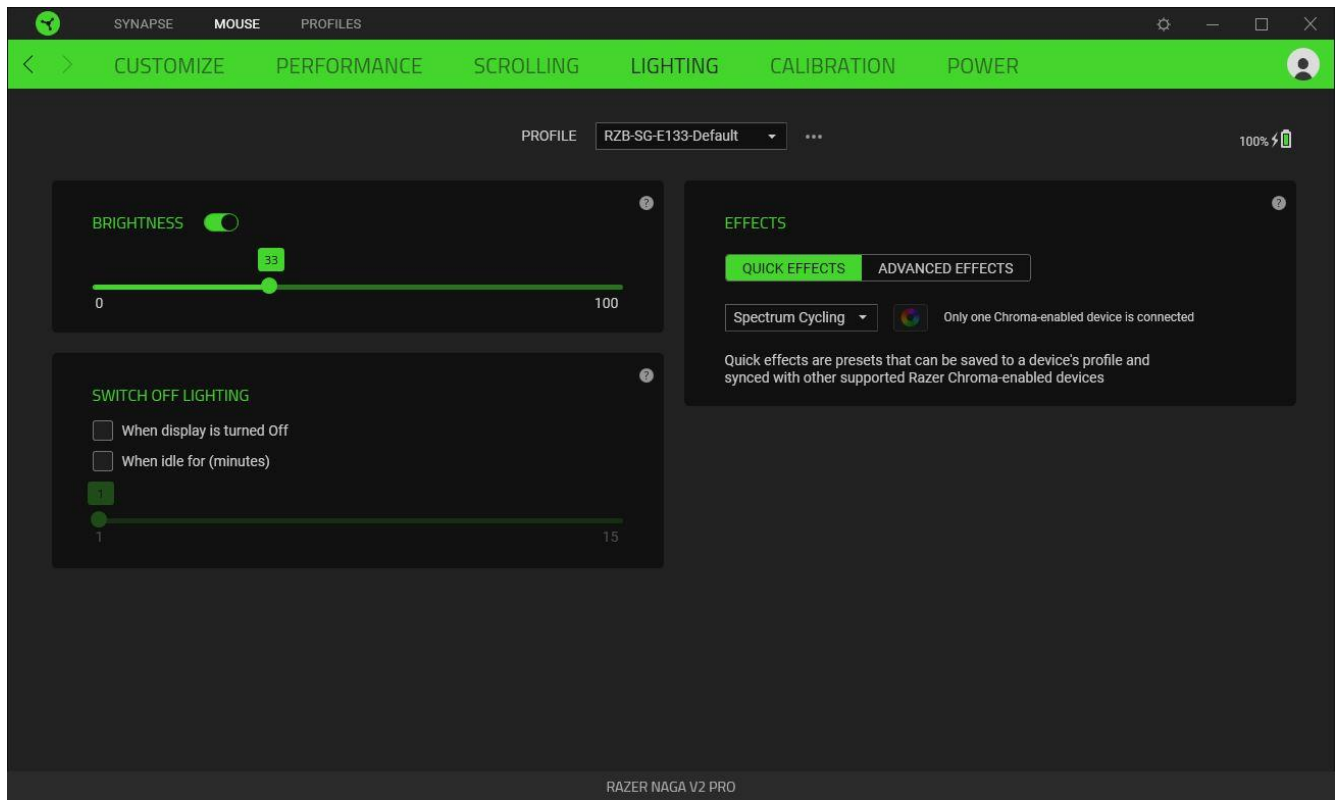

### Brightness

You can turn off your Razer device's lighting by toggling the Brightness option or increase/decrease the luminance using the slider.





### Switch Off Lighting

This power-saving tool allows you to disable your device's lighting in response to your system's display turning off and/or automatically power down when your Razer Naga V2 Pro has been idle for a set time.

### Quick effects

Several quick effects can be selected and applied to your mouse's lighting, as listed here:

	Name	Description	How to set up
	Audio meter	The LEDs will light up according to the audio level with a default spectrum of colors	Select a Color Boost level

	Breathing	The lighting will fade in and out of the selected color(s)	Select up to 2 colors or randomize colors
	Reactive	The LEDs will light up when you click any of the mouse buttons	Select a color and a duration
	Spectrum cycling	The lighting will cycle between 16.8 million colors indefinitely	No further customization required
	Static	The LEDs will remain lit in the selected color	Select a color

If you have other supported Razer Chroma-enabled devices, you can synchronize their quick effects with your Razer device by clicking the Chroma Sync button (  ).

 *Only devices that support the selected lighting effect will synchronize.*

### Advanced Effects

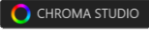
The Advanced Effects option allows you to choose a Chroma Effect you want to use on your Razer Chroma-enabled peripheral. To start making your own Chroma Effect, simply press the Chroma Studio button (  ).

## Calibration

The Calibration subtab allows you to optimize your Razer Precision Sensor to any surface for better tracking.

### Smart Tracking

Smart Tracking lets you set the distance at which the sensor stops tracking when it is lifted from its surface to avoid unwanted cursor movement. By selecting the Enable Asymmetric Cut-Off, you may assign different values to the lift-off and landing distances.

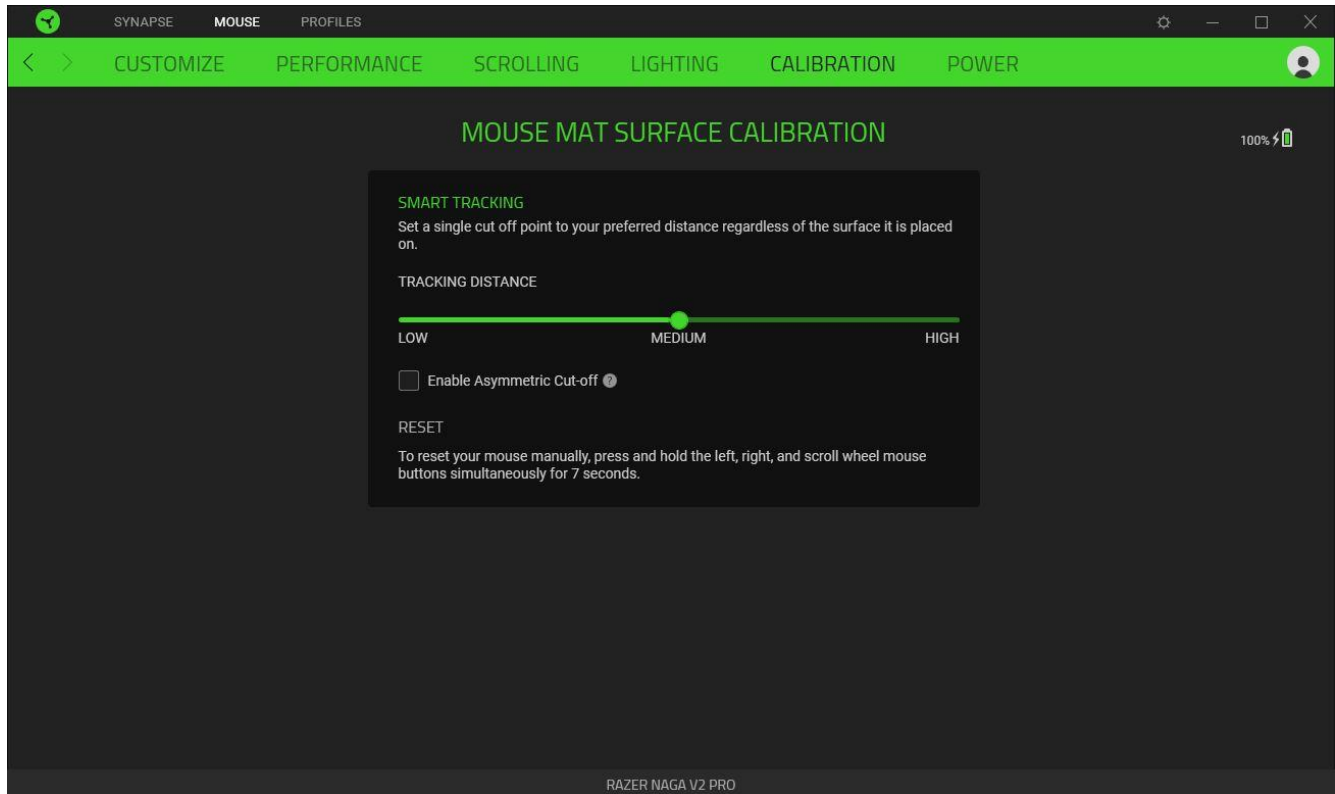

## Power

The Power subtab allows you to set your device to enter sleep mode when idle for a certain amount of time or manage its energy consumption when wireless.

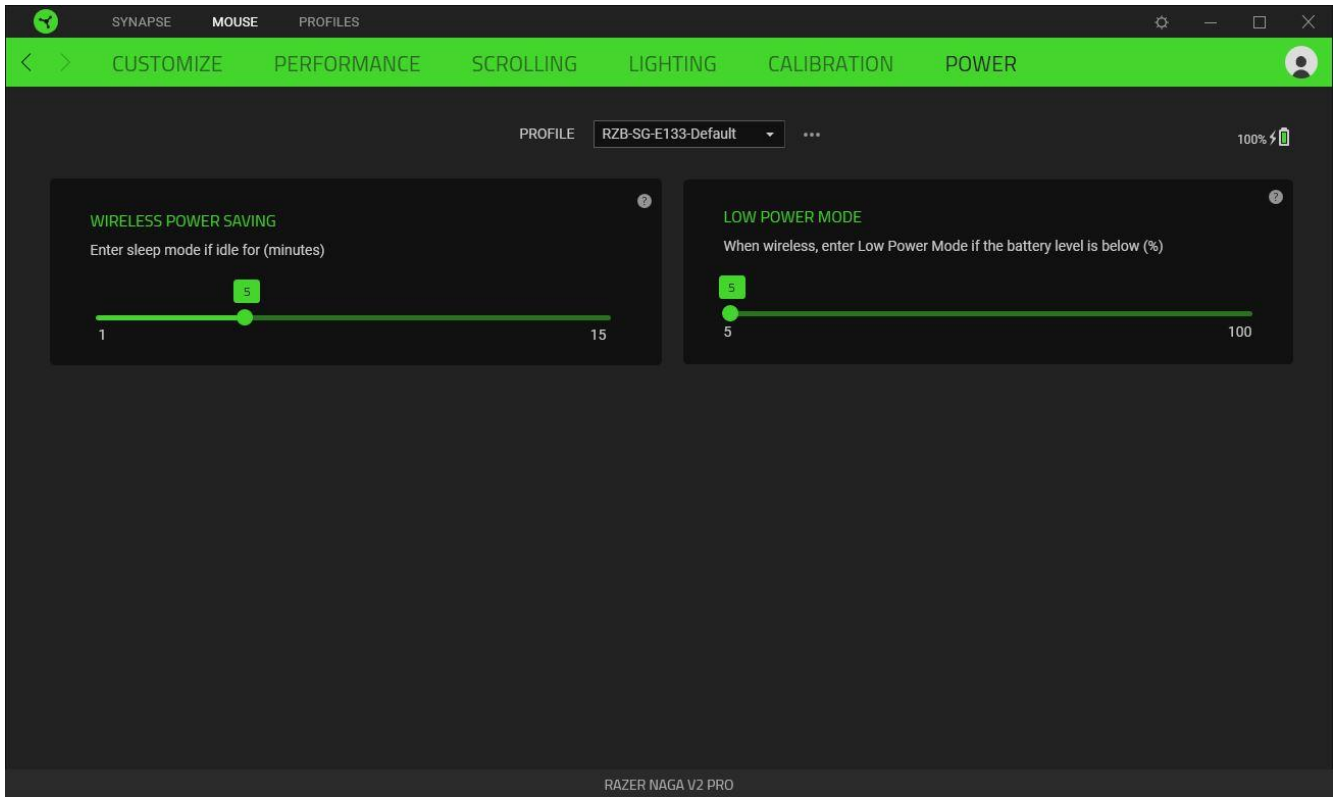





## PROFILES TAB

The Profiles tab is a convenient way to manage all your profiles and link them to your games and applications.

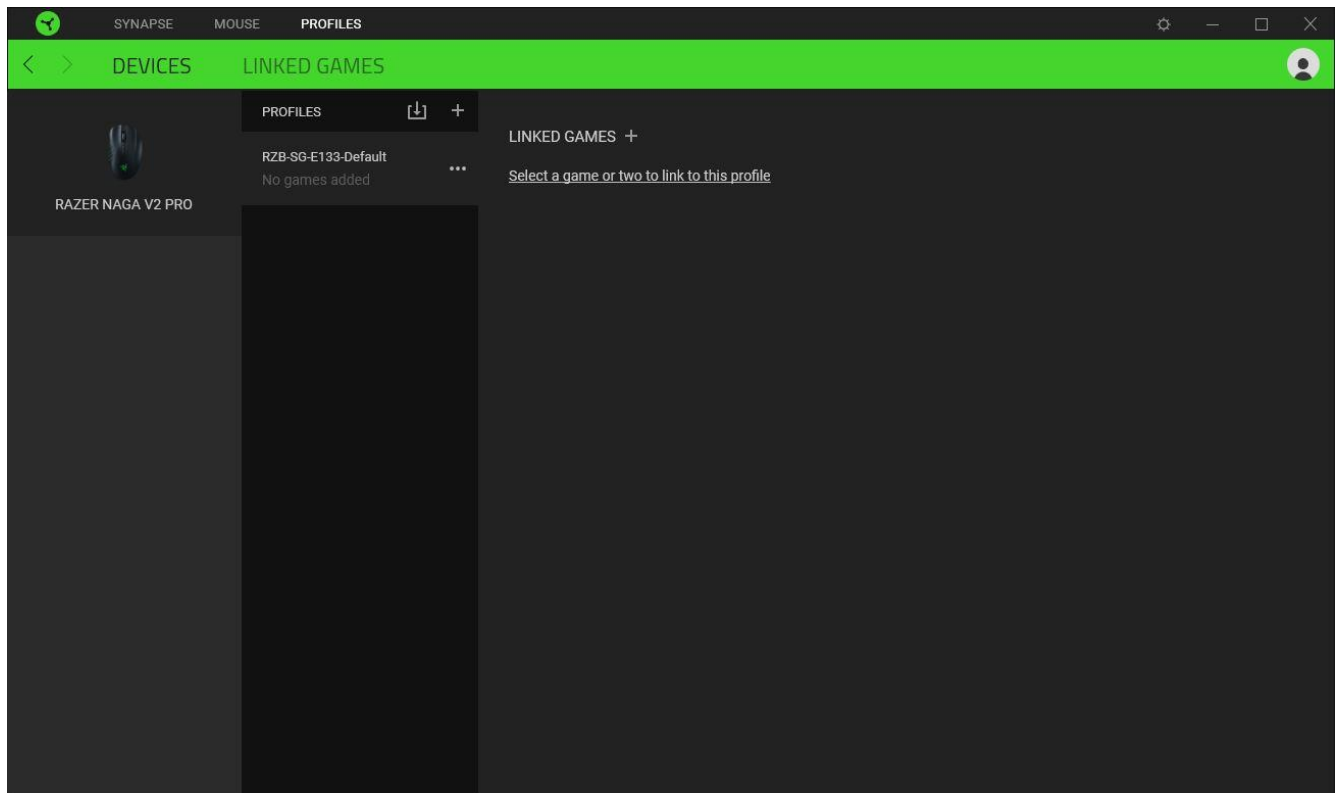
### Devices

View which games are linked to each device's profiles or which Chroma Effect is linked to specific games using the Devices subtab.



You can import Profiles from your computer or the cloud through the import button (  ) or create new profiles within the selected device using the add button (  ). To rename, duplicate, export, or delete a profile, press the Miscellaneous button (  ). Each profile can be set to activate when you run an application using the Linked Games option.



## Linked Games

The Linked Games subtab allows you to add games, view devices linked to games, or search for added games. You can also sort games based on alphabetical order, last played, or most played. Added games will still be listed here, even if they are not linked to a Razer device.

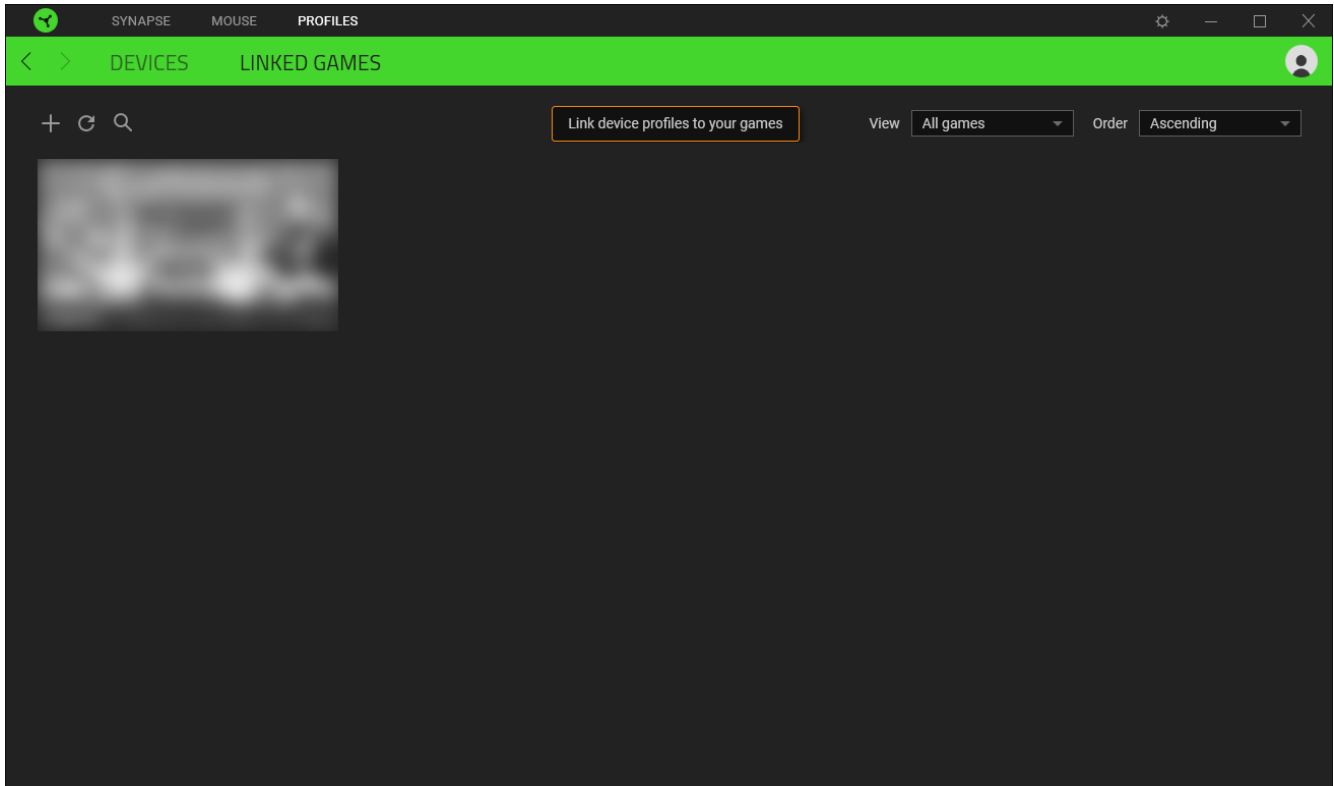

To link games to connected Razer devices or Chroma Effects, simply click on any game from the list, and then click **Select a device and its profile to launch automatically during gameplay** to select the Razer device or Chroma Effect it will link with. Once connected, you may click the Miscellaneous button ( ●●● ) of the corresponding Chroma Effect or device to select a specific Chroma Effect or profile.

## SETTINGS WINDOW

The Settings window, accessible by clicking the (⚙️) button on Razer Synapse, enables you to configure the startup behavior and display language of Razer Synapse, view the master guides of each connected Razer device, or perform a factory reset on any connected Razer device.

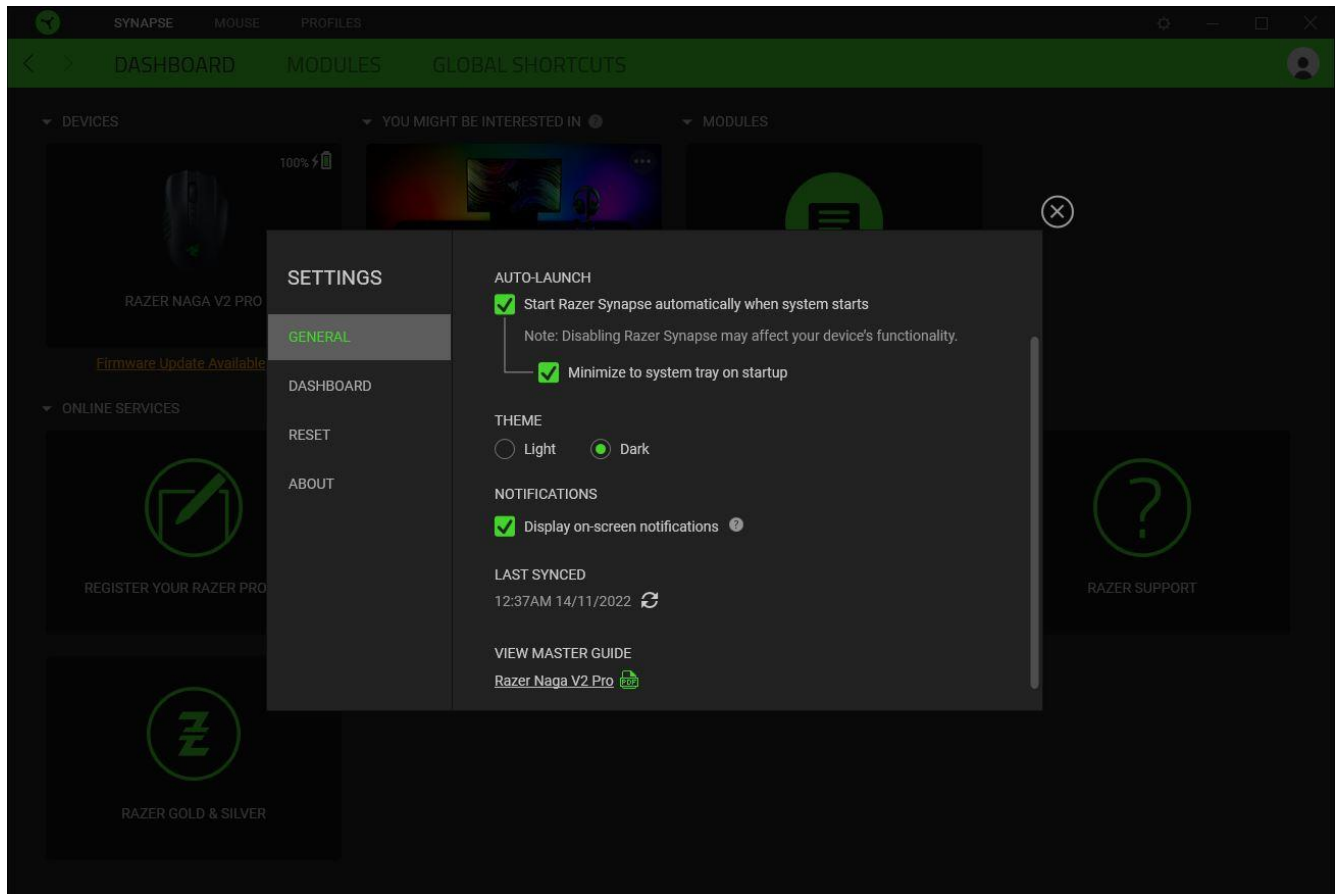

### General tab

The General tab lets you change the software's display language, startup behavior, theme, and on-screen notifications display. You may also manually sync your profiles to the cloud (↻) or view the master guide of all connected Razer devices and installed modules.

### Dashboard tab

Use the Dashboard tab to customize which Razer device recommendations based on your setup, and the games you play will appear on the Dashboard.

### Reset tab

The Reset tab allows you to perform a factory reset on all connected Razer devices with on-board memory and/or reset Razer Synapse tutorials to acquaint yourself again with Razer Synapse's new features on its next launch.



*All profiles stored on the selected device's on-board memory will be erased when you reset a Razer device.*

## **About tab**

The About tab displays brief software information and copyright statement, and provides relevant links for its terms of use. You may also use this tab to check for software updates, or as quick access to Razer's social communities.

---

## 8. SAFETY AND MAINTENANCE

### SAFETY GUIDELINES

To achieve maximum safety while using your Razer Naga V2 Pro, we suggest that you adopt the following guidelines:

Should you have trouble operating the device properly and troubleshooting does not work, unplug the device and contact the Razer hotline or go to [support.razer.com](https://support.razer.com) for support.

Do not take apart the device, and do not attempt to operate it under abnormal current loads. Doing so will void your warranty.

The Razer Naga V2 Pro requires a USB connection that can supply sufficient power to charge the device. The charging process may be affected when connecting to a non-powered USB hub or non-powered USB, mostly found on keyboards and peripherals.

Keep the device away from liquid, humidity, or moisture. Operate the device only within the specific temperature range of 0°C (32°F) to 40°C (104°F). Should the temperature exceed this range, unplug and/or switch off the device to stabilize the temperature to an optimal level.

### COMFORT

Research has shown that long periods of repetitive motion, improper positioning of your computer peripherals, incorrect body position, and poor habits may be associated with physical discomfort and injury to nerves, tendons, and muscles. Below are some guidelines to avoid injury and ensure optimum comfort while using your Razer Naga V2 Pro.

- Position your keyboard and monitor directly in front of you with your mouse next to it. Place your elbows next to your side, not too far away, and your keyboard within easy reach.
- Adjust the height of your chair and table so that the keyboard and mouse are at or below elbow height.
- Keep your feet well supported, posture straight, and your shoulders relaxed.
- During gameplay, relax your wrist and keep it straight. If you do the same tasks with your hands repeatedly, try not to bend, extend or twist your hands for long periods.
- Do not rest your wrists on hard surfaces for long periods. Use a wrist rest to support your wrist while gaming.
- Do not sit in the same position all day. Get up, step away from your desk and do exercises to stretch your arms, shoulders, neck, and legs.

If you experience any physical discomfort while using your mouse, such as pain, numbness, or tingling in your hands, wrists, elbows, shoulders, neck, or back, please consult a qualified medical doctor immediately.

## **MAINTENANCE AND USE**

The Razer Naga V2 Pro requires minimum maintenance to keep it in optimum condition. Once a month, we recommend you unplug the device from the computer and clean it using a soft cloth or cotton swab to prevent dirt buildup. Do not use soap or harsh cleaning agents.

To get the ultimate experience in movement and control, we highly recommend a premium mouse mat from Razer. Some surfaces will cause undue wear on the feet requiring constant care and eventual replacement.

Do note that the sensor of the Razer Naga V2 Pro is 'tuned' or optimized especially for the Razer mouse mats. This means that the sensor has been tested extensively to confirm that the Razer Naga V2 Pro reads and tracks best on Razer mouse mats.

## **BATTERY WARNING**

The Razer Naga V2 Pro contains a Li-ion rechargeable battery. In general, the life expectancy of such batteries is dependent upon usage. If you suspect that the Li-ion rechargeable battery inside the Razer Naga V2 Pro may be drained (has a low charge), try charging it.

**Caution:** Do not open, mutilate, or expose to conducting materials (metal), moisture, liquid, fire, or heat. Doing so may cause batteries to leak or explode, resulting in personal injury. Battery life varies with usage.

---

## 9. LEGALESE

### **COPYRIGHT AND INTELLECTUAL PROPERTY INFORMATION**

©2023 Razer Inc. All rights reserved. Razer, the triple-headed snake logo, Razer logo, "For Gamers. By Gamers.", and "Powered by Razer Chroma" logo are trademarks or registered trademarks of Razer Inc. and/or affiliated companies in the United States or other countries. All other trademarks are the property of their respective owners.

The Bluetooth® word mark and logos are registered trademarks owned by Bluetooth SIG, Inc., and any use of such marks by Razer is under license.

Windows and the Windows logo are trademarks of the Microsoft group of companies.

Razer Inc. ("Razer") may have copyright, trademarks, trade secrets, patents, patent applications, or other intellectual property rights (whether registered or unregistered) concerning the product in this guide. Furnishing of this guide does not give you a license to any such copyright, trademark, patent or other intellectual property right. The Razer Naga V2 Pro (the "Product") may differ from pictures whether on packaging or otherwise. Razer assumes no responsibility for such differences or for any errors that may appear. Information contained herein is subject to change without notice.

### **LIMITED PRODUCT WARRANTY**

For the latest and current terms of the Limited Product Warranty, please visit [razer.com/warranty](https://www.razer.com/warranty).

### **LIMITATION OF LIABILITY**

Razer shall in no event be liable for any lost profits, loss of information or data, special, incidental, indirect, punitive or consequential or incidental damages, arising in any way out of distribution of, sale of, resale of, use of, or inability to use the Product. In no event shall Razer's liability exceed the retail purchase price of the Product.

### **GENERAL**

These terms shall be governed by and construed under the laws of the jurisdiction in which the Product was purchased. If any term herein is held to be invalid or unenforceable, then such term (in so far as it is invalid or unenforceable) shall be given no effect and deemed to be excluded without invalidating any of the remaining terms. Razer reserves the right to amend any term at any time without notice.