



Laundry Combo

User manual

WD53DBA9**H*

SAMSUNG

Contents

Safety information	4
What you need to know about the safety instructions	4
Important safety symbols	4
Important safety precautions	5
CALIFORNIA PROPOSITION 65 WARNING	6
Critical installation warnings	6
Installation cautions	8
Critical usage warnings	8
Usage cautions	10
Critical cleaning warnings	14
Care for preventing freezing	14
Regulatory notice	15
FCC Notice	15
IC Notice	17
Open Source Announcement	18
Installation	19
Unpacking your Laundry Combo	19
What's included	20
Installation requirements	22
Step-by-step installation	25
Before you start	30
Initial setup	30
Run Calibration (recommended)	30
Laundry guidelines	31
Detergent drawer guidelines	33
Operations	39
LCD panel	39
Operating a cycle	42
Cycle overview	43
Cycle chart	46
Settings	51
Special features	57
SmartThings	58

Maintenance	60
Product Care	60
Self Clean+	61
Self Dry	62
Emergency drain	63
Cleaning	65
Recovery from freezing	73
Care for an extended period of non-use	74
Cleaning the exterior	74
Cleaning the interior	74
Troubleshooting	75
Checkpoints	75
Information codes	81
Specifications	83
Fabric care chart	83
Protecting the environment	84
Declaration of conformity	84
Specification sheet	85

Safety information

Congratulations on your new Samsung Laundry Combo. This manual contains important information on the installation, use and care of your appliance. Please take some time to read this manual to take full advantage of your Laundry Combo's many benefits and features.

What you need to know about the safety instructions

Please read this manual thoroughly to ensure that you know how to safely and efficiently operate the extensive features and functions of your new appliance. Please store the manual in a safe location close to the appliance for future reference. Use this appliance only for its intended purpose as described in this instruction manual.

Warnings and Important Safety Instructions in this manual do not cover all possible conditions and situations that may occur. It is your responsibility to use common sense, caution and care when installing, maintaining and operating your Laundry Combo.

Because the following operating instructions cover various models, the characteristics of your Laundry Combo may differ slightly from those described in this manual and not all warning signs may be applicable. If you have any questions or concerns, contact your nearest service center or find help and information online at www.samsung.com.

Important safety symbols

What the icons and signs in this user manual mean:

 **WARNING**

Hazards or unsafe practices that may result in **severe personal injury, death and/or property damage.**

 **CAUTION**

Hazards or unsafe practices that may result in **personal injury and/or property damage.**

 **NOTE**

Indicates that a risk of personal injury or material damage exists.

These warning signs are here to prevent injury to yourself and others.

Please follow them explicitly.

After reading this manual, store it in a safe place for future reference.

Read all instructions before using the appliance.

As with any equipment that uses electricity and moving parts, potential hazards exist. To safely operate this appliance, familiarize yourself with its operation and exercise care when using it.

SAVE THESE INSTRUCTIONS

Important safety precautions

WARNING

To reduce the risk of fire, electric shock, or injury to persons when using your appliance, follow basic precautions, including the following:

1. Read all instructions before using this appliance.
2. DO NOT wash or dry articles that have been previously cleaned in, washed in, soaked in, or spotted with gasoline, dry-cleaning solvents, other flammable or explosive substances as they give off vapors that could ignite or explode.
3. DO NOT use the appliance to dry clothes which have traces of any flammable substance, such as vegetable oil, cooking oil, machine oil, flammable chemicals, paint thinner, etc., or anything containing wax or chemicals, such as mops and cleaning cloths. Flammable substances may cause the fabric to catch fire by itself.
4. DO NOT store or use combustible materials, gasoline or other flammable liquids near the unit. Keep area around the air intake vent on the front of the unit and adjacent surrounding areas free from the accumulation of lint, dust and dirt.
5. Risk of Suffocation and Injury from Entrapment: Do not allow children to play on or in the appliance. Close supervision of children is necessary when the appliance is used near children.
6. Before the appliance is removed from service or discarded, remove the door to the washing or drying compartment.
7. DO NOT reach into the appliance if the tub or agitator is moving.
8. DO NOT install or store this appliance where it will be exposed to the weather.
9. DO NOT tamper with controls.
10. DO NOT repair or replace any part of the appliance or attempt any servicing unless specifically recommended in the user-maintenance instructions or in published user-repair instructions that you understand and have the skills to carry out.
11. DO NOT add gasoline, dry-cleaning solvents, or other flammable or explosive substances to the wash water. These substances give off vapours that could ignite or explode.
12. Under certain conditions, hydrogen gas may be produced in a hot-water system that has not been used for 2 weeks or more. HYDROGEN GAS IS EXPLOSIVE. If the hot-water system has not been used for such a period, before using a washing machine, turn on all hot-water faucets and let the water flow from each for several minutes. This will release any accumulated hydrogen gas. As the gas is flammable, do not smoke or use an open flame during this time.
13. DO NOT use fabric softeners or products to eliminate static unless recommended by the manufacturer of the fabric softener or product.
14. Clean lint screen before or after each load.

SAVE THESE INSTRUCTIONS

Safety information

15. DO NOT use heat to dry articles containing foam rubber or similarly textured rubber-like materials.
16. Keep area around the exhaust opening and adjacent surrounding areas free from the accumulation of lint, dust, and dirt.
17. The interior of the appliance should be cleaned periodically by qualified service personnel.
18. DO NOT place items exposed to cooking oils in your dryer. Items contaminated with cooking oils may contribute to a chemical reaction that could cause a load to catch fire. To reduce the risk of fire due to contaminated loads, the final part of a tumble dryer cycle occurs without heat (cool down period). Avoid stopping a tumble dryer before the end of the drying cycle unless all items are quickly removed and spread out so that the heat is dissipated.
19. This appliance must be grounded. See “Electrical requirements” and “Grounding” in “Installation” section.
20. The control board, inlet valve and motors are intentionally not grounded and may present a risk of electric shock only during servicing.
 - DO NOT contact these parts while the appliance is energized.
21. DO NOT operate this appliance if it is damaged, malfunctioning, partially disassembled, or has missing or broken parts including a damaged cord or plug.
22. Unplug the appliance or turn off the circuit breaker before servicing. Pressing the Power button DOES NOT disconnect power.
23. DO NOT use replacement parts that have not been recommended by the manufacturer (e.g. parts made at home using a 3D printer).

CALIFORNIA PROPOSITION 65 WARNING

WARNING

Cancer and Reproductive Harm - www.P65Warnings.ca.gov.

Critical installation warnings

WARNING

The installation of this appliance must be performed by a qualified technician or service company.

- Failure to do so may result in electric shock, fire, an explosion, problems with the appliance, or injury.

The appliance is heavy, therefore take care when lifting it.

SAVE THESE INSTRUCTIONS



Plug the power cord firmly into a wall socket that meets local electrical specifications. Use the socket for this appliance only, and do not use an extension cord.

- Sharing a wall socket with other appliances using a power strip or extending the power cord may result in electric shock or fire.
- Ensure that the power voltage, frequency, and current are the same as those of the product specifications. Failure to do so may result in electric shock or fire.

Remove all foreign substances such as dust or water from the power plug terminals and contact points using a dry cloth on a regular basis.

- Unplug the power plug and clean it with a dry cloth.
- Failure to do so may result in electric shock or fire.

Plug the power plug into the wall socket so that the cord is running towards the floor.

- If you plug the power plug into the socket in the opposite direction, the electric wires within the cable may be damaged and this may result in electric shock or fire.

Keep all packaging materials out of the reach of children as these may be dangerous.

- If a child places a bag over its head, it may suffocate.

When the appliance, power plug or power cord is damaged, contact your nearest service center.

This appliance must be properly grounded.

Do not ground the appliance to a gas pipe, plastic water pipe, or telephone line.

- This may result in electric shock, fire, an explosion, or problems with the appliance.
- Never plug the power cord into a socket that is not grounded correctly and make sure that it is in accordance with local and national regulations.

Do not install this appliance near a heater or any inflammable material.

Do not install this appliance in a humid, oily or dusty location, or in a location exposed to direct sunlight or water (raindrops).

Do not install this appliance in a location exposed to low temperatures.

- Frost may cause the tubes to burst.

Do not install this appliance in a location where gas may leak.

- This may result in electric shock or fire.

Do not install or keep the product exposed to the outdoor elements.

Do not use an electric transformer.

- This may result in electric shock or fire.

Do not use a damaged power plug, damaged power cord or loose wall socket.

- This may result in electric shock or fire.

Do not pull or excessively bend the power cord.

SAVE THESE INSTRUCTIONS



Safety information

Do not twist or tie the power cord.

Do not hook the power cord over a metal object, place a heavy object on the power cord, insert the power cord between objects, or push the power cord into the space behind the appliance.

- This may result in electric shock or fire.

Do not unplug the appliance by pulling the power cord.

- Unplug the power plug by holding the plug.
- Failure to do so may result in electric shock or fire.

This appliance should be positioned so that the power plug, the water supply taps, and the drain pipes are accessible.

Following the repair by a non-authorized service provider, self-repair or non-professional repair of the product, Samsung is not liable for any damage to the product, any injury or any other product safety issue caused by any attempt to repair the product which does not carefully follow these repair and maintenance instructions. Any damage to the product caused by an attempt to repair the product by any person other than a Samsung certified service provider will not be covered by the warranty.

Installation cautions

CAUTION

Install your appliance on a solid, level floor that can support its weight.

- Failure to do so may result in abnormal vibrations, movement, noise, or problems with the appliance.

Critical usage warnings

WARNING

If the appliance is flooded, turn off the water and power supplies immediately and contact your nearest service center.

- Do not touch the power plug with wet hands.
- Failure to do so may result in electric shock.

If the appliance generates a strange noise, a burning smell, or smoke, unplug the power cord immediately and contact your nearest service center.

- Failure to do so may result in electric shock or fire.

In the event of a gas leak (such as propane gas, LP gas, etc.), ventilate immediately without touching the power plug. Do not touch the appliance or power cord.

- Do not use a ventilating fan.

SAVE THESE INSTRUCTIONS

-
- A spark may result in an explosion or fire.

Remove all door levers before disposing of the appliance.

- If trapped inside the appliance, children may suffocate to death.

Make sure to remove the packaging (sponge, styrofoam) attached to the bottom of the Laundry Combo before using it.

Do not wash items contaminated with gasoline, kerosene, benzene, paint thinner, alcohol or other inflammable or explosive substances.

- This may result in electric shock, fire, or explosion.

Do not open the door by force while operating.

- Water flowing out of the Laundry Combo may result in burns or cause the floor to be slippery. This may result in injury.
- Opening the door by force may result in damage to the appliance or injury.

Do not sit on the appliance or lean against the doors.

- The appliance may fall over causing a serious injury.

Dry the laundry only after it was spun by an appropriate washing machine.

Do not dry laundry contaminated by inflammable materials such as gasoline, kerosene, benzene, thinner, alcohol, etc.

- This may result in electric shock, fire or explosion.

Do not touch the power plug with wet hands.

- This may result in electric shock.

Do not turn the appliance off by unplugging the power cord while an operation is in progress.

- Plugging the power cord into the wall socket again may cause a spark and result in electric shock or fire.

Do not let children climb in or onto the appliance.

- This may result in electric shock, burns or injury.

Do not insert your hand or a metal object under the Laundry Combo while it is operating.

- This may result in injury.

Do not unplug the appliance by pulling the power cord. Always grip the plug firmly and pull it straight out of the outlet.

- Damage to the power cord may cause a short-circuit, fire and/or electric shock.

Do not attempt to repair, disassemble, or modify the appliance yourself.

- Do not use a fuse (such as copper, steel wire, etc.) other than a standard fuse.
- When the appliance needs to be repaired or reinstalled, contact your nearest service center.
- Failure to do so may result in electric shock, fire, problems with the appliance, or injury.

SAVE THESE INSTRUCTIONS

Safety information

If the water supply hose comes loose from the water tap and floods the appliance, unplug the power cord.

- Failure to do so may result in electric shock or fire.

Unplug the power cord when the appliance is not being used for long periods of time or during a thunder or lightning storm.

- Failure to do so may result in electric shock or fire.

If any foreign substance enters into the appliance, unplug the power cord and contact your nearest Samsung Customer Service.

- This may result in electric shock or fire.

Keep your pets away from the appliance to prevent them from chewing any parts of the Laundry Combo, which may result in electric shock, fire, or injury.

Usage cautions

CAUTION

When the Laundry Combo is contaminated by a foreign substance such as detergent, dirt, food waste, etc., unplug the power cord and clean the Laundry Combo using a damp, soft cloth.

- Failure to do so may result in discoloration, deformation, damage, or rust.

The glass parts may break by a strong impact. Take care when using the Laundry Combo.

- If the glass is broken, it may result in injury.

Open the water tap slowly after a long period of non-use, water supply failure, or when reconnecting the water supply hose.

- The air pressure in the water supply hose or the water pipe may damage a part of the appliance or result in a water leak.

If a draining error occurs during an operation, check if there is a draining problem.

- If the Laundry Combo is used when it is flooded because of a draining problem, it may result in electric shock or fire.

Insert the laundry into the Laundry Combo completely so that the laundry does not get caught in the door.

- If laundry gets caught in the door, it may result in damage to the laundry or the appliance, or result in a water leak.

Turn the water supply off when the Laundry Combo is not being used.

- Ensure that the screws on the water supply hose connector are properly tightened.

SAVE THESE INSTRUCTIONS



Ensure that the rubber seal and front door glass are not contaminated by a foreign substance (such as waste, thread, hair, etc.).

- If a foreign substance is caught in the door or the door is not completely closed, it may cause a water leak.

Open the water tap and check if the water supply hose connector is firmly tightened and that there is no water leak before using the appliance.

- If the screws on the water supply hose connector are loose, it may result in a water leak.

The appliance you have purchased is designed for domestic use only.

Using the appliance for business purposes qualifies as an appliance misuse. In this case, the appliance will not be covered by the standard warranty provided by Samsung and no responsibility can be attributed to Samsung for malfunctions or damages resulting from such misuse.

Do not stand on the appliance or place objects (such as laundry, lighted candles, lighted cigarettes, dishes, chemicals, metal objects, etc.) on the appliance.

- This may result in electric shock, fire, problems with the appliance, or injury.

Do not spray volatile material such as insecticide onto the surface of the appliance.

- As well as being harmful to humans, this may result in electric shock, fire or problems with the appliance.

Do not place objects that generate electromagnetic fields near the Laundry Combo.

- This may result in injury due to a malfunction.

Water drained during a high-temperature wash or drying cycle is hot. Do not touch the water.

- This may result in burns or injury.

Draining time may vary depending on the water temperature. If the water temperature is too high, the draining process starts after the water cools down.

Do not wash, spin, or dry water-proof seats, mats, or clothing (*) unless your model has a special cycle for these items.

(*): Woollen bedding, rain covers, fishing vests, ski pants, sleeping bags, diaper covers, sweat suits, and bicycle, motor cycle and car covers, etc.

- Do not wash thick or hard mats even if the washing machine mark is on the care label. This may result in injury or damage to the Laundry Combo, walls, floor, or clothing due to abnormal vibrations.
- Do not wash throw rugs or doormats with rubber backing. The rubber backing may come off and stick to inside the drum, and this may result in malfunction such as a drainage error.

Do not operate the Laundry Combo when the detergent drawer is removed.

- This may result in electric shock or injury due to a water leak.

Do not touch the insides of the drum during or just after drying as it is hot.

- This may result in burns.

SAVE THESE INSTRUCTIONS



Safety information

Do not touch the inside of the glass door and the drum after washing and drying as those parts may become hot and could cause burns.

Do not insert your hand into the detergent drawer.

- This may result in injury as your hand may be caught by the detergent input device.

Remove the liquid detergent guide (applicable models only) when using powdered detergent.

- If not, water may leak through the front of the detergent drawer.

Do not place any objects (such as shoes, food waste, or animals) other than laundry into the Laundry Combo.

- This may result in damage to the Laundry Combo, or injury and death in the case of pets because of the abnormal vibrations.

Do not press the buttons using sharp objects such as pins, knives, fingernails, etc.

- This may result in electric shock or injury.

Do not wash or dry laundry contaminated by oils, creams or lotions usually found in skincare shops or massage clinics.

- This may cause the rubber seal to become deformed and result in a water leak.

Do not leave metal objects such as safety pins or hairpins in the drum for long periods of time.

- This may cause the drum to rust.
- If rust starts appearing on the surface of the drum, apply a (neutral) cleansing agent to the surface and use a sponge to clean it. Never use a metal brush.

Do not use dry cleaning detergent directly and do not wash, rinse, or spin laundry contaminated by dry cleaning detergent.

- This may result in spontaneous combustion or ignition due to the heat from the oxidation of the oil.

Do not use water from water cooling/heating devices.

- This may result in problems with the Laundry Combo.

Do not use natural hand-washing soap for the Laundry Combo.

- If it hardens and accumulates inside the Laundry Combo, it may result in problems with the appliance, discoloration, rust, or bad odors.

Place socks and brassieres in a washing net and wash them with the other laundry.

Do not wash large laundry items such as bedding in the washing net.

- Failure to do so may result in injury due to abnormal vibrations.

Do not use hardened detergent.

- If it accumulates inside the Laundry Combo, it may result in a water leak.

SAVE THESE INSTRUCTIONS



Make sure that the pockets of all the clothing items are empty.

- Hard, sharp objects such as coins, safety pins, nails, screws, or stones can cause extensive damage to the appliance.

Do not wash or dry clothing with large buckles, buttons, or other heavy metal objects.

Sort the laundry by color on the basis of its colorfastness and select the recommended cycle, water temperature and additional functions.

- This may result in discoloration or fabric damage.

Take care that children's fingers are not caught in the door when closing it.

- Failure to do so may result in injury.

To prevent odors and mold, leave the door open after completing a cycle to allow the drum to dry.

To prevent limescale build-up, leave the detergent drawer open after a wash cycle and dry inside it.

Do not dry laundry containing forming rubber (latex) or similar rubber textures.

- If forming rubber is heated, it may start a fire.

If necessary, use the laundry net for small and lightweight laundry such as fabric tie belts, apron strings, and underwire bras which can break during a cycle.

Dryer sheets are compatible with this model, and are recommended for better drying performance.

Dryer sheets are also beneficial in reducing the static electricity generated during a drying cycle. Static electricity could lead to damaging laundry items and potentially the appliance.

Do not use the Laundry Combo near dangerous powders such as coal dust, wheat flour, etc.

- This may result in electric shock, fire or an explosion.

Do not touch the rear side of the appliance during or immediately after drying is complete.

- The appliance remains hot and may cause burns.

SAVE THESE INSTRUCTIONS



Safety information

Critical cleaning warnings

WARNING

Do not clean the appliance by spraying water directly onto it.

Do not use a strong acidic cleaning agent.

Do not use benzene, thinner or alcohol to clean the appliance.

- This may result in discoloration, deformation, damage, electric shock or fire.

Before cleaning or performing maintenance, unplug the appliance from the wall socket.

- Failure to do so may result in electric shock or fire.

Clean the filter case before and after using the Laundry Combo.

Clean the inside of the product on a regular basis by asking an authorized service engineer.

Care for preventing freezing

WARNING

Install the Laundry Combo in an area where the temperature does not drop below a water-freezing temperature.

If draining directly using a long drain hose, water remaining inside the hose can freeze in winter. Make sure there is no water left inside the hose after use.

If the drain hose has frozen, wrap the hose with a towel soaked in warm water for approximately ten minutes to thaw it.

SAVE THESE INSTRUCTIONS

Regulatory notice

FCC Notice

CAUTION

Any changes or modifications not expressly approved by the party responsible for compliance could void the user's authority to operate the equipment.

This device complies with Part 15 of FCC Rules. Operation is subject to the following two conditions:

1. This device may not cause harmful interference, and
2. This device must accept any interference received including interference that cause undesired operation.

For products sold in the US and Canadian markets, only channels 1–11 are available. You cannot select any other channels.

FCC STATEMENT:

This equipment has been tested and found to comply within the limits for a Class B digital device, pursuant to part 15 of the FCC Rules. These limits are designed to provide reasonable protection against harmful interference in a residential installation.

This equipment generates, uses, and can radiate radio frequency energy and, if not installed and used in accordance with the instructions, may cause harmful interference to radio communications. However, there is no guarantee that interference will not occur in a particular installation. If this equipment does cause harmful interference to radio or television reception, which can be determined by turning the equipment off and on, the user is encouraged to try to correct the interference by one or more of the following measures:

- Reorienting or relocating the receiving antenna
- Increasing the separation between the equipment and receiver
- Connecting the equipment to an outlet that is on a different circuit than the radio or TV.
- Consulting the dealer or an experienced radio/TV technician for help.

FCC RADIATION EXPOSURE STATEMENT:

This equipment complies with FCC radiation exposure limits set forth for an uncontrolled environment. This equipment should be installed and operated so there is at least 8 inches (20 cm) between the radiator and your body. This device and its antenna(s) must not be colocated or operated in conjunction with any other antenna or transmitter.

SAVE THESE INSTRUCTIONS

Regulatory notice

FCC Compliance Statement (applicable models only)

Model	WD53DBA900HZ
Variant model	WD53DBA9**H* 1st * and 2nd * : Number 0 through 9 indicates a specific feature. 3rd * : Letter A through Z indicates the color of appliance.
Responsible Party - U.S. Contact Information	Samsung Electronics America, Inc. 85 Challenger Road Ridgefield Park, NJ 07660 Phone : 1-800-SAMSUNG (726-7864)

This device complies with Part 15 of the FCC Rules. Operation is subject to the following two conditions: (1) This device may not cause harmful interference, and (2) This device must accept any interference received, including interference that may cause undesired operation.

SAVE THESE INSTRUCTIONS



IC Notice

The term "IC" before the radio certification number only signifies that Industry Canada technical specifications were met. Operation is subject to the following two conditions:

1. This device may not cause interference, and
2. This device must accept any interference, including interference that may cause undesired operation of the device.

This Class B digital apparatus complies with Canadian ICES-003.

Cet appareil numérique de la classe B est conforme à la norme NMB-003 du Canada.

For products sold in the US and Canadian markets, only channels 1–11 are available. You cannot select any other channels.

IC RADIATION EXPOSURE STATEMENT:

This equipment complies with IC RSS-102 radiation exposure limits set forth for an uncontrolled environment. This equipment should be installed and operated so there is at least 8 inches (20 cm) between the radiator and your body. This device and its antenna(s) must not be colocated or operated in conjunction with any other antenna or transmitter.



SAVE THESE INSTRUCTIONS



Regulatory notice

Open Source Announcement

The software included in this product contains open source software. You may obtain the complete corresponding source code for a period of three years after the last shipment of this product by contacting our support team via <http://opensource.samsung.com> (Please use the "Inquiry" menu.)

It is also possible to obtain the complete corresponding source code in a physical medium such as a CD-ROM; a minimal charge will be required.

The following URL http://opensource.samsung.com/opensource/SMART_AT_051/seq/0 leads to the open source license information as related to this product. This offer is valid to anyone in receipt of this information.



SAVE THESE INSTRUCTIONS

Installation

Follow these instructions carefully to ensure proper installation of the Laundry Combo and to prevent accidents when doing laundry.

⚠ WARNING

Certain internal parts are intentionally not grounded and may present a risk of electric shock only during servicing. Service personnel – Do not contact the following parts while the appliance is energized: Control board, heat sink, motor, inlet valve and pump.

Unpacking your Laundry Combo

Unpack your Laundry Combo and inspect it for shipping damage. Make sure you have received all the items shown on the next page. If your Laundry Combo was damaged during shipping, or you do not have all of the items, call 1-800-SAMSUNG (1-800-726-7864). To prevent personal injury or strain, wear protective gloves whenever lifting or carrying the unit.

WARNING — Packing materials can be dangerous to children; Keep all packing material (plastic bags, polystyrene, etc.) well out of children's reach.

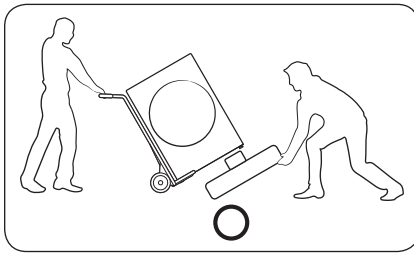

⚠ CAUTION

You must have at least 2 people unpack the Laundry Combo. To remove the cushion bottom of the packing materials, do not tip the Laundry Combo over on its front side.

When you lay the Laundry Combo down to remove the carton base, protect the side of the Laundry Combo and lay it down carefully. Never lay your Laundry Combo on its back or front.

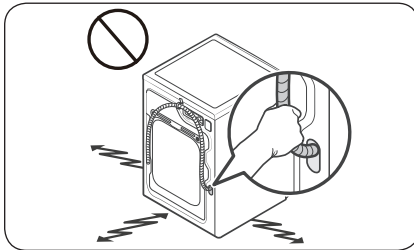

⚠ CAUTION

Do not grab or pull the drain hose to drag and move the product.

Installation

What's included

Make sure all the parts are included in the product package. If you have a problem with the Laundry Combo or the parts, contact a local Samsung customer center or retailer.

NOTE

The appearance of the actual product may differ from the image shown.

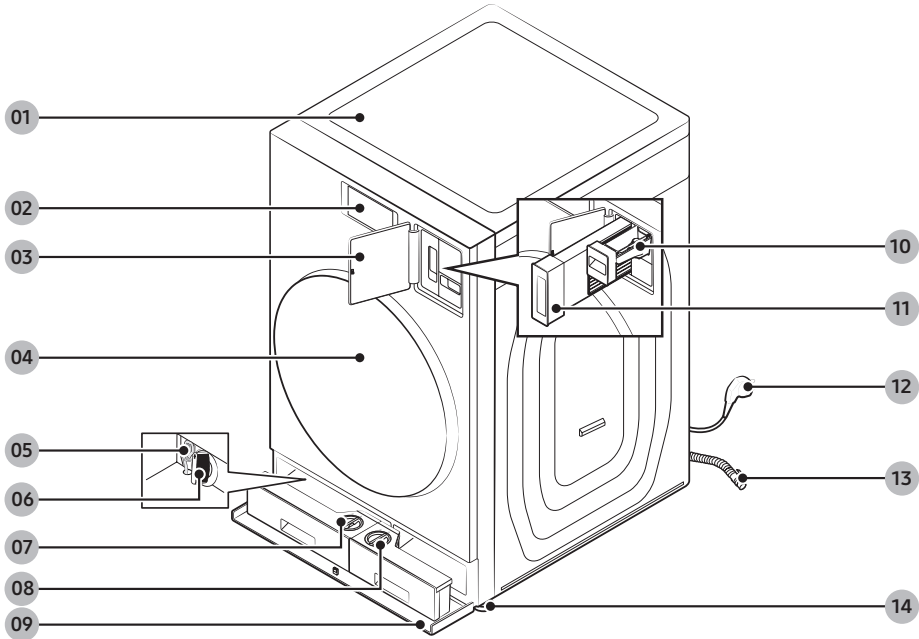

01 Worktop

02 LCD panel

03 Lint filter cover

04 Door

05 Emergency drain tube

06 Drain filter

07 Auto dispenser

08 Flex auto dispenser

09 Compartment cover

10 Manual bleach dispenser

11 Lint filter

12 Power plug

13 Drain hose

14 Levelling feet

Parts supplied



Wrench



Bolt caps

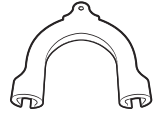

Hose guide

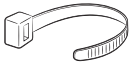

Cable tie



Anti-slip pads



Aqua Pebble

Parts sold separately

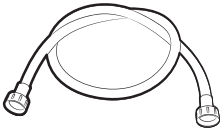

Water hoses



Appliance Brush*

Tools needed for installation



Phillips screwdriver



Level



Adjustable pliers

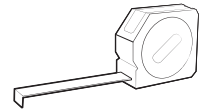

Measuring tape

NOTE

- Bolt caps: The number (3 to 6) of bolt caps provided depends on the model.
- The appearance of the Laundry Combo and provided accessories may differ with the model.
- To purchase an accessory or lost part, contact a local Samsung service center or retailer.
- * Appliance brush: Purchase a flexible cleaning brush designed to bend for cleaning the heat exchanger. (Minimum length: 680 mm)
 - Water hoses and appliance brushes are not sold in Samsung service center or retailers.

Installation

CAUTION

- Do not reuse old water hoses, which may leak or burst, causing flooding and/or property damage.
- Make sure rubber washers are inserted in each coupling of both water hoses.

Installation requirements

Electrical supply and grounding

- AC 120 V / 60 Hz / 15 AMP fuse or circuit breaker is required.
- Use an individual branch circuit. Connect only the Laundry Combo to the circuit.

To ensure proper grounding, the Laundry Combo comes with a power cord featuring a three-prong grounding plug for use in a properly installed and grounded outlet.

Check with a qualified electrician or service person if you are not sure about the grounding.

Do not modify the provided plug. If it does not fit the outlet, call a qualified electrician to install a proper outlet.

WARNING

- Do NOT use an extension cord.
- Use only the power cord that comes with the Laundry Combo.
- Do NOT connect the ground wire to plastic plumbing, gas lines, or hot water pipes.
- Improperly connected grounding conductors may cause electric shock.
- To prevent unnecessary risk of fire, electrical shock, or personal injury, all wiring and grounding must be done in accordance with local codes, or in the absence of local codes, in accordance with the National Electrical Code, ANSI/NFPA No. 70-Latest Revision (for the U.S.) or the Canadian Electrical Code CSA C22.1 – Latest Revisions and local codes and ordinances. It is your responsibility to provide adequate electrical service for your Laundry Combo.

Water supply

The proper water pressure for this Laundry Combo is between 20-116 psi (137-800 kPa). Water pressure less than 20 psi (137 kPa) may cause the water valve not to close completely. Or, it may take longer to fill the drum, causing the Laundry Combo to turn off. Water taps must be within 4 ft. (122 cm) from the rear of the Laundry Combo so that the inlet hoses reach the Laundry Combo.

To reduce the risk of leaks:

- Make sure water taps are easily accessible.
- Turn off the taps when the Laundry Combo is not in use.
- Check for any leaks at the water inlet hose fittings on a regular basis.

CAUTION

Before using the Laundry Combo for the first time, check all connections at the water valve and taps for any leaks.

Drain

Samsung recommends a standpipe 18 in. (460 mm) high. The drain hose must be connected through the hose clip to the standpipe, and the standpipe must fully cover the drain hose.

Flooring

For best performance, the Laundry Combo must be installed on a solid floor. Wood floors may need to be reinforced to minimize vibration and/or unbalanced loads. Carpeting and soft tile surfaces do not provide good resistance to vibrations and may cause the Laundry Combo to move slightly during the spin cycle.

⚠ CAUTION

Do NOT install the Laundry Combo on a platform or a poorly supported structure.

Water temperature

Do not install the Laundry Combo in areas where water may freeze as the Laundry Combo always retains some water in its water valves, pumps, and/or hoses. Frozen water can cause damage to belts, the pump, and other components of the Laundry Combo.

Dimensions

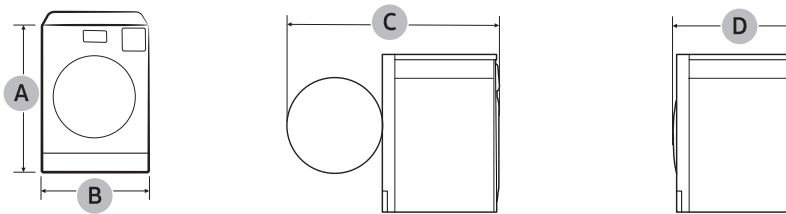

A. Overall height	43.7 in. (1110 mm)
B. Width	27 in. (686 mm)
C. Depth with door open	56.3 in. (1430 mm)
D. Depth	34.4 in. (875 mm)

Installation

Clearance requirement

Alcove or closet installations

Minimum clearance for stable operation

Sides	Top	Rear	Front
1 in. (25 mm)	1 in. (25 mm)	2 in. (50 mm)	1 in. (25 mm)

If the Laundry Combo is installed in the same location with other washer or dryer, the front of the alcove or closet must have two unobstructed air openings for a combined minimum total area of 72 in.² (465 cm²).

Custom cabinet and side-by-side installation

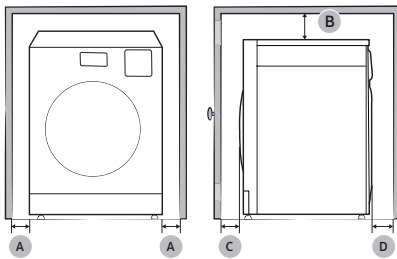

A	1 in. (25 mm)
B	1 in. (25 mm)
C	1 in. (25 mm)
D	2 in. (50 mm)

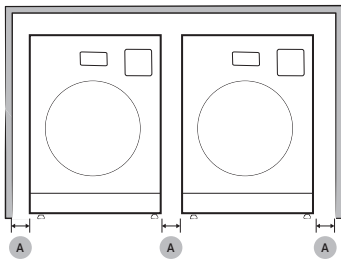

CAUTION

Please be aware of the following when installing and using the product.

- After plugging the power plug, make sure the power cord does not get pressed or pinched by the product while you push it into the final installation position.
 - This could cause fire or electric shock.
- The product must be installed in a place where it can be easily plugged. Otherwise, an electrical leakage may occur and lead to electric shock or fire.
- Plug the power cord into a grounded 3-prong outlet.
 - Never cut or remove the third (grounding) prong from the power cord under any circumstances.

Step-by-step installation

STEP 1 Select a location

Location requirements:

- A solid, level surface without carpeting or flooring that may obstruct ventilation
- No direct sunlight
- Adequate room for ventilation and wiring
- Ambient temperature always higher than the freezing point (32 °F / 0 °C)
- Away from heat sources

STEP 2 Remove the shipping bolts

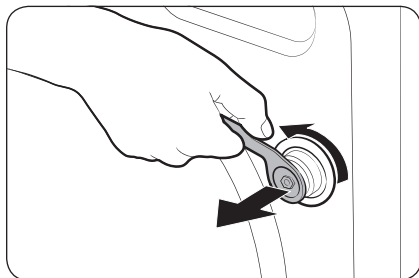

Unpack the product package and remove all shipping bolts.

1. Loosen all shipping bolts on the rear of the machine using the wrench.

 **NOTE**

Use the enclosed end of the supplied wrench to remove the shipping bolts.

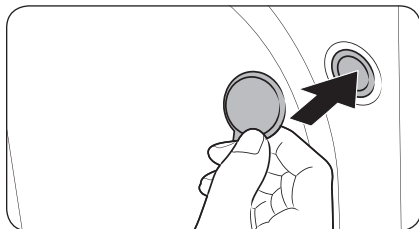

2. Fill the holes with the supplied plastic bolt caps. Keep the shipping bolts for future use.

 **WARNING**

- The shipping bolts secure the tub during product transportation and reduce the chance of suspension damage. Remove the shipping bolts before using the product and only reinsert them if you need to move the product.
- Packaging materials can be dangerous to children. Dispose all packaging material (plastic bags, polystyrene, etc.) out of children's reach.

Installation

STEP 3 Adjust the leveling feet

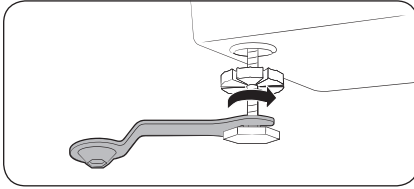

1. Gently slide the Laundry Combo into position. Excessive force may damage the leveling feet.
2. Using a wrench, turn the leveling feet clockwise or counterclockwise to adjust the height until the Laundry Combo is level.

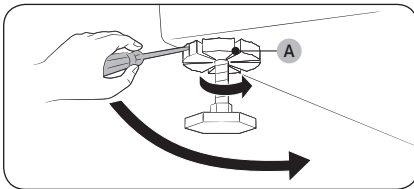

3. Using a flathead screwdriver, tighten the **locking nuts (A)**.

NOTE

Use the open-end of the supplied wrench to adjust the leveling feet.

STEP 4 Connect the water hose

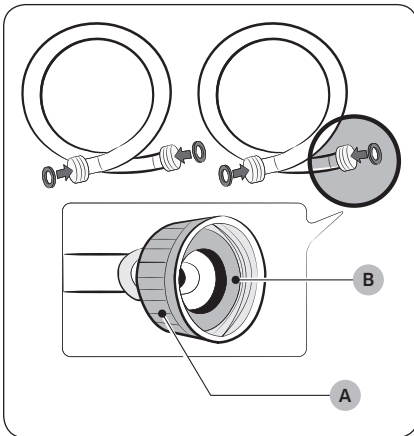

CAUTION

- Make sure to use new water hoses and that **rubber gaskets (B)** are inside the **couplings (A)** at both ends of the hoses. Water hoses without the gaskets may leak.
- Allow 5 in. (127 mm) of space between the back of the Laundry Combo and the wall to prevent water hoses from being kinked. Kinked hoses may cause water leaks.
- If there is a water leak, stop using the Laundry Combo and contact a local Samsung service center. A water leak may cause electric shock.
- Do not stretch the water hoses by force. If a hose is too short, replace the hose with a longer hose.

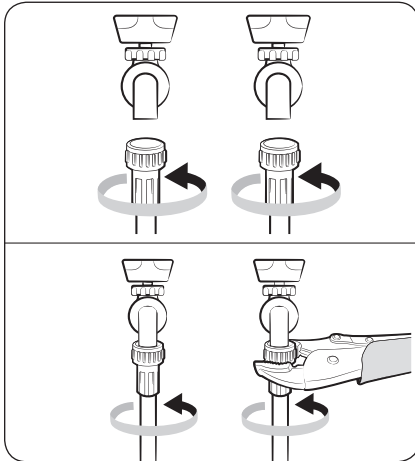

1. Attach the water hoses to the hot and cold water taps, and then hand tighten the water hose fittings until they are tight. Then, use pliers to tighten the fittings by an additional two-thirds of a turn. To avoid damaging the fittings, do not overtighten them.
2. Pull the water hoses to check if they are firmly connected.

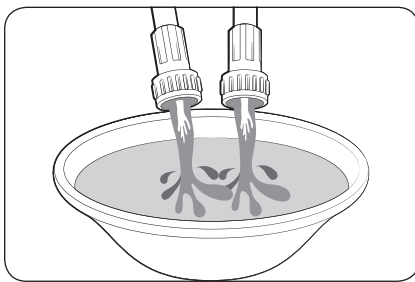

3. Put the other ends of the hoses into a bucket, and then open the water taps for 10 - 15 seconds to remove impurities. When done, close the taps.

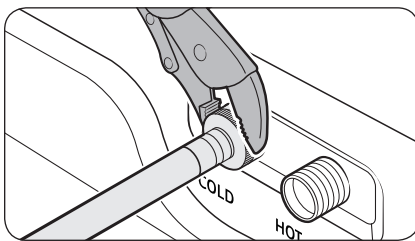

4. Attach the water hoses to the hot and cold water inlets on the back of the Laundry Combo, and then hand tighten the water hose fittings until they are tight. Then, use pliers to tighten the fittings by an additional two-thirds of a turn.

NOTE

If you do not want to use the hot water supply hose, attach the water intake cap to the hot water supply intake. When you do a wash, tap **Temp.** and select **Tap Cold**.

Installation

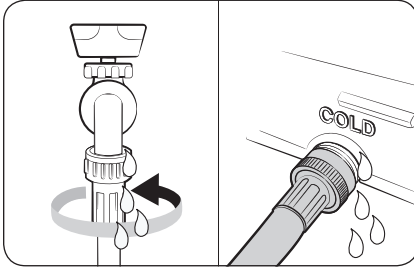

5. Open the water taps, and check for leaks.

STEP 5 Connect the drain hose

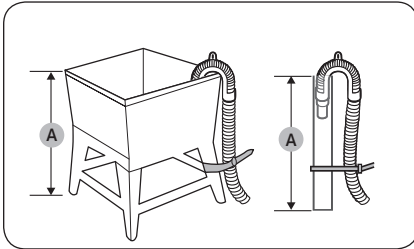

To a Laundry Tub or Drain Pipe

1. Check the **height (A)** of your drain system and make sure the minimum and maximum heights shown below are met.

Minimum	18 in. (46 cm)
Maximum	96 in. (245 cm)

NOTE

- Make sure to measure the height from the floor where the Laundry Combo is placed.
- Draining efficiency may be reduced if the drain system is at the maximum height.
- To prevent the Laundry Combo from siphoning water, do not use a drain system below the minimum height.

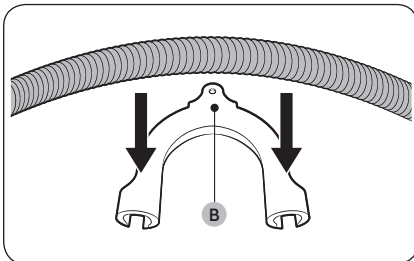

2. Attach the drain hose to the **plastic hose guide (B)**.

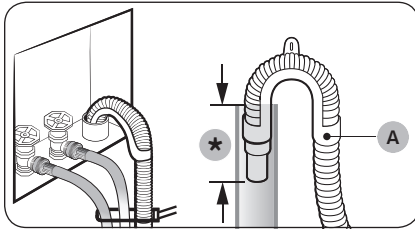

(*): Min. 6 in. (152 mm), Max. 8 in. (203 mm)

3. Route the drain hose to the drain system.

⚠ CAUTION

- If using a standpipe, make sure the standpipe and drain hose connection is not airtight.
- If using a standpipe, make sure the drain hose is inserted at least 6 in. (152 mm) but no more than 8 in. (203 mm) into the standpipe.

4. Secure the drain hose with cable ties.

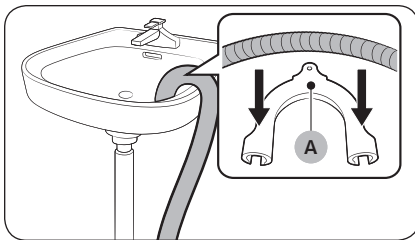

Over the edge of a wash basin

The drain hose must be placed no lower than 24 in. (60 cm) and no higher than 35 in. (90 cm) from the floor. To keep the spout of the drain hose bent, use the supplied **plastic hose guide (A)**. Secure the guide to the wall using a hook to ensure stable drainage.

STEP 6 Power on

Plug the power cord into an AC 120 V / 60 Hz / 15 AMP approved electrical outlet protected by a fuse or circuit breaker. Then, tap  to turn on the Laundry Combo.

Before you start

Initial setup



- When you turn on the Laundry Combo for the first time, the screen shows the initial setup process. Follow the on-screen instructions to complete it.
- Once you select a language, the language selection screen will not reappear. However, you must complete a wash cycle once to stop the tutorial screen from reappearing.
 - You can change the language from the Settings menu. On the Home screen, tap **Settings > General > Language** to change the language.
- The initial setup includes language selection and a brief tutorial.
- Tap **OK** to skip to the next screen.

NOTE

If the initial setup screen does not appear during the first use of the product, it does not indicate a problem with the product. You can adjust the desired settings by selecting **Settings > General** from the Home screen, or reset the product to try running the initial setup process by selecting **Settings > General > Reset > Reset all settings**.

Run Calibration (recommended)

Calibration ensures accurate weight detection by the Laundry Combo. Make sure the drum is empty before running calibration.

1. Tap  to turn the power on.
2. Tap  > **Washer > Calibration**.
3. Tap **Start Calibration** to start the calibration.

Laundry guidelines

STEP 1 Sort

Sort the laundry according to these criteria:

- Care Label: Sort the laundry into cottons, mixed fibers, synthetics, silks, wools, and rayon.
- Color: Separate whites from colors.
- Size: Mixing different sized items together in the drum improves the washing performance.
- Sensitivity: Wash delicate items separately. For pure, new woolen items, curtains, and silk items, check the labels on the items.

 **NOTE**

Make sure to check the care label on all clothing, and sort clothing accordingly before starting the wash.

STEP 2 Empty pockets

Empty all the pockets of your laundry items

- Metal objects such as coins, pins, and buckles on clothing may damage other laundry items as well as the drum.

Turn clothing with buttons and embroideries inside out

- If pants or jacket zippers are open while washing, the drum may be damaged. Zippers should be closed and fixed with a string.
- Clothing with long strings may become entangled with other clothes. Make sure to tie the strings before starting the wash.

STEP 3 Use a laundry net

- Brassieres (water washable) must be placed in a laundry net. Metal parts of the brassieres may break through and tear other laundry items.
- Small, light clothing such as socks, gloves, stockings, and handkerchiefs may become caught around the door. Place them inside a fine laundry net.
- Do not wash the laundry net by itself without other laundry. This may cause abnormal vibrations that could move the Laundry Combo and result in injury.

Before you start

STEP 4 Determine the load capacity

Do not overload the Laundry Combo. Overloading may cause the Laundry Combo to wash improperly.

NOTE

When washing bedding or bedding covers, the wash time may be lengthened or the spin efficiency may be reduced.

For bedding or bedding covers, the recommended maximum spin level is Low or Medium, and the load capacity is 7 lb (3.0 kg) or less.

CAUTION

If the laundry is unbalanced and the "**Unbalanced laundry detected**" information code is displayed, redistribute the load. Unbalanced laundry may reduce spinning performance.

STEP 5 Add the correct detergent type

The type of detergent you use - general purpose, specifically for woolens, etc. - depends on the type of fabric (cotton, synthetic, delicate items, wool), color, wash temperature, and degree of soiling. Regardless of the specific type of detergent you use, always use "low suds" HE laundry detergent which is designed for automatic washers.

NOTE

- Follow the detergent manufacturer's recommendations based on the weight of the laundry, the degree of soiling, and the hardness of the water in your local area. If you are not sure about the water hardness, contact your local water authority.
- Do not use detergent that tends to harden or solidify. This detergent may remain after the rinse cycle, blocking the drain outlet.

CAUTION

When washing wool using the Wool cycle, use only a neutral liquid detergent. Powdered detergent used with the Wool cycle can remain on the laundry and discolor it.

Use HE detergent only



For the best cleaning results, use a high efficiency detergent such as Tide HE, Wisk HE, Cheer HE or Gain HE*. High efficiency detergents contain suds suppressors that reduce or eliminate suds. When fewer suds are produced, the load tumbles more efficiently and cleaning is maximized. (* Brand names are trademarks of their respective manufacturers.)

WARNING

For best results, use HE detergents only. Do not use non-HE detergent, organic detergent, natural detergent or HE detergents with natural ingredients (such as vinegar, baking soda).

Detergent drawer guidelines

NOTE

Auto dispensers make laundry easier by dispensing the preset amount of washing agents without you having to pour it in every time, and it could be more economical because the exact amount will be dispensed each time of use, allowing less waste of washing agents.

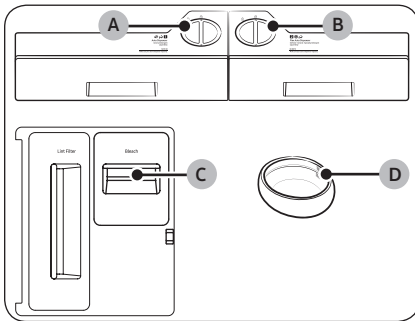

A. Auto dispenser

- You can use the general detergent in this compartment.
- Use liquid detergent only. Do not put powdered detergent or softener.

B. Flex auto dispenser

- You can set this dispenser to dispense detergent (**General detergent** or **Specialty detergent**) or softener.
- Use only neutral detergent in this dispenser if you have set the **Detergent type** to **Specialty detergent**.
- Do not put powdered detergent.

C. Manual bleach compartment

- Add liquid chlorine bleach. Do not exceed the max line.

D. Aqua Pebble

- To use the Aqua Pebble, set the **Amount** option for **Auto dispenser** and **Flex auto dispenser** to **Off**.
- Do not use the Aqua Pebble for bleach or fabric softener.

CAUTION

- Do not operate the Laundry Combo without the dispensers in the detergent drawer.
 - A water leak may cause electric shock or injury.
- Do not use the following types of detergent in the drawer.
 - Tablet, capsule, ball, or net types.
- Do not use gel-type or viscous detergent/softener in the detergent drawer as they may not flow well.
 - Read the detergent/softener manufacturer's instructions before using them in the Laundry Combo.
- Do not carry around the dispenser removed from the detergent drawer. Put the dispenser back in place.
 - Otherwise, the dispenser may shake and cause the content to spill out.
- Empty the dispensers in the detergent drawer before moving the Laundry Hub to prevent any content from spilling out on the floor.
- Do not use chlorine bleach, which may damage the laundry.

Before you start

- Use caution when inserting the Aqua Pebble as it is supposed to be balanced on top of the laundry at the beginning of the wash. Tipping the Aqua Pebble before the start of a wash may cause detergent residue to remain on the laundry at the end of the wash, causing discoloration of the laundry or reduced washing performance.
- Before each wash, clean the Aqua Pebble before adding fresh detergent.
- Do not insert the Aqua Pebble into a folded item or between different laundry items.
- Do not use liquid or powdered chlorine bleach.
- Do not put or store cleaning agents such as detergent, bleach, or fabric softener on your Laundry Combo. Wipe up any spills immediately to prevent damage to the Laundry Combo, especially the finish and the LCD panel.

NOTE

- If the message "**Needs refill**" appears on the display, refill the corresponding dispenser.
- The detergent/softener is not automatically dispensed in the **Wool**, **Delicates**, and **Activewear** cycles if the **Detergent type** for **Auto dispenser** and **Flex auto dispenser** are set to **General detergent**. You must use the Aqua Pebble to put the detergent directly into the drum.
 - However, if the **Detergent type** for **Flex auto dispenser** is set to **Specialty detergent**, the detergent will be dispensed automatically.
- Do not exceed the max line when filling detergent and softener.
- It may be hard to open the detergent drawer with just your fingertips. Grab the detergent drawer handle firmly with your hand and pull to open it.
- Push the detergent drawer all the way to the end to close it.
- If you feel the softener scent is weak, set the softener input amount to a higher level.

To use bleach

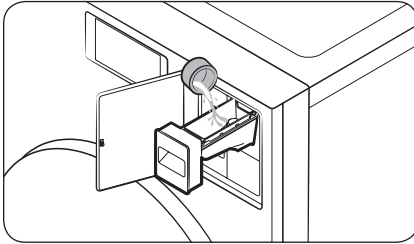

Add only liquid chlorine bleach to the **Manual bleach dispenser**. Do not exceed the **max line**.

⚠ CAUTION

- Do not add the liquid bleach without the liquid detergent guide in the Manual bleach dispenser.
- Do not add undiluted liquid chlorine bleach directly to the load or to the drum. It is a powerful chemical and can cause fabric damage, such as weakening of the fibers or color loss if not used properly.

To use oxygen boosters or color-safe bleach

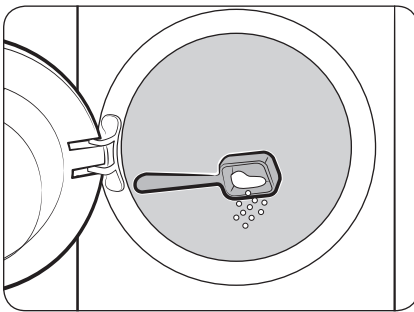

Oxygen boosters or color-safe bleach can increase washing performance. Make sure to add the oxygen booster or color-safe bleach after putting the laundry into the drum.

📖 NOTE

To use both powdered detergent and powdered oxygen booster or powdered color-safe bleach, it is more effective to put them together into the drum before loading the laundry.

To use Aqua Pebble

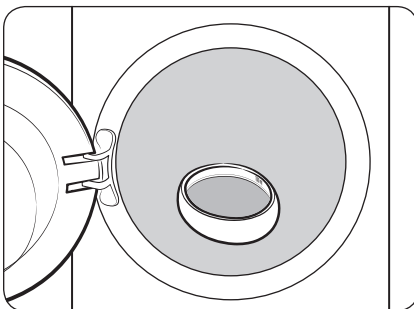

Pour the recommended amount of liquid or powdered detergent (specialty detergent) into the Aqua Pebble, and then put the Aqua Pebble directly into the drum. There are two guidelines inside the Aqua Pebble to indicate 50 ml (1.69 fl oz) and 100 ml (3.38 fl oz). Do not exceed the 100 ml line.

Before you start

To apply washing agents to the Auto dispensers

NOTE

If the message "Needs refill" appears on the display, refill the corresponding dispenser.

- The detection time may vary depending on the type of the detergent/softener.

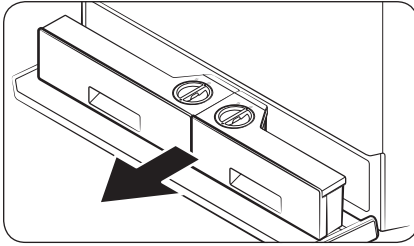

1. Press the Compartment cover to open it.
2. Pull out the Auto dispensers

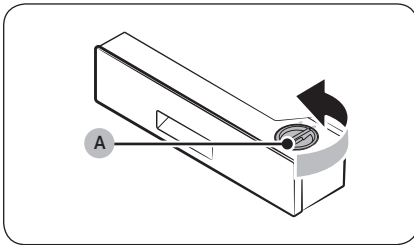

3. Turn the **Auto dispenser cap (A)** counterclockwise to open.

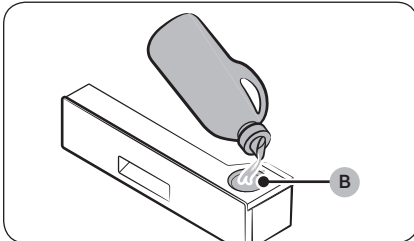

4. Apply an appropriate amount of detergent to the **Auto dispenser (B)**.
 - After you finish, put the cap back and turn it clockwise to close.

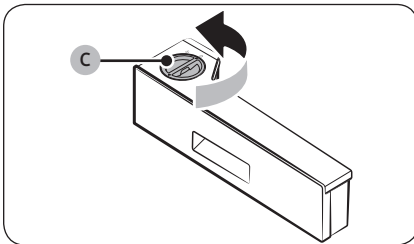

5. Turn the **Flex auto dispenser cap (C)** counterclockwise to open.

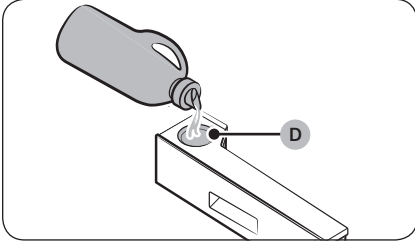

6. Apply an appropriate amount of detergent (General detergent or Specialty detergent) or softener to the **Flex auto dispenser (D)**.
 - After you finish, put the cap back and turn it clockwise to close.

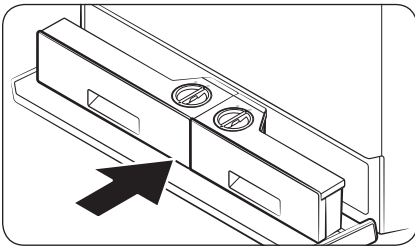

7. Push the Auto dispensers back into their positions.
8. Close the Compartment cover.

Before you start

Dispenser care

You can check the detergent type used in each dispenser.

NOTE

On the Dispenser care screen, the current status of detergent and fabric softener is displayed and will alert you if any of the dispensers are running low. Follow the on-screen instructions to refill the detergent or fabric softener.

1. On the Home screen, tap **Dispenser care** to move to the Dispenser care screen.
2. Check the amount of detergent in each dispenser and fill the dispenser if the amount is low.
3. Tap  to move to the Home screen.



Operations

⚠ WARNING

To reduce the risk of fire, electric shock, or injury to persons, read the **Safety information** before operating this Laundry Combo.

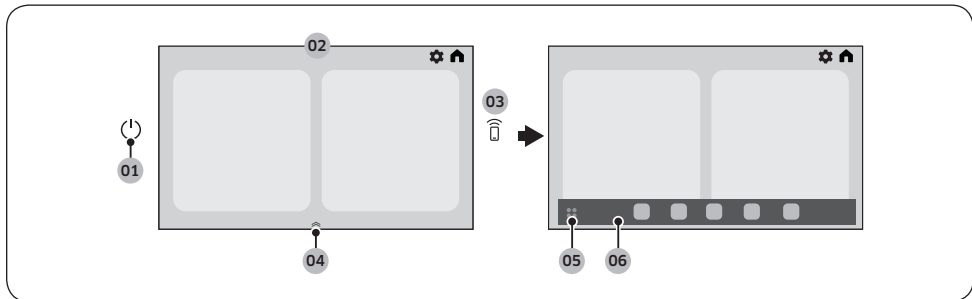





LCD panel







01 Power 	Tap to turn the Laundry Combo on or off.
02 Display	The display shows current cycle information and estimated time remaining, or an information message when a problem occurs.
03 Smart Control 	Tap to activate or deactivate the Smart Control function. Touch and hold to enter pairing mode to connect to the SmartThings app. <ul style="list-style-type: none"> When the Smart Control function is activated, you can control your Laundry Combo remotely using the SmartThings app on your smartphone or tablet (Android or iOS). For more information on Smart Control, see page 57.
04 App dock handler	Drag the App dock handler upward to open the App dock. <ul style="list-style-type: none"> The App dock handler only appears on the Home screen.
05 App tray button	Tap to view all available apps. <ul style="list-style-type: none"> App drawer: Tap App tray to open App drawer. You can open the App drawer to quickly open the SmartTings, Timer, Bixby, Weather, Ring, Internet, or Settings app.
06 App dock	App dock displays the icons to allow easier access to the frequently used apps. <ul style="list-style-type: none"> Maximum five icons are displayed in the App dock and they are editable.

Operations

Display icon descriptions

	Home	Tap to go to the Home screen.
	Settings	Tap to enter the Settings menu. <ul style="list-style-type: none"> For more information on Settings, see page 51.
	Door Lock	<ul style="list-style-type: none"> This icon indicates the door is locked and cannot be opened. The door locks automatically during a cycle and this icon turns on. You can open the door when this icon disappears.
	Smart Control	<ul style="list-style-type: none"> This icon indicates that the Smart Control is on.
 	Washer (Wash Options)	This icon appears during a wash-only cycle or a washing process. You can tap this icon to change the cycle settings. Tap the desired button to change the default wash cycle settings. <ul style="list-style-type: none"> Temp.: Tap to change the water temperature for the selected cycle. Spin: Tap to change the spin speed for the selected cycle. <ul style="list-style-type: none"> Rinse Hold & No Spin: The final rinse process is suspended so that the laundry remains in the water. To unload the laundry, run a drain or spin process. Drain & No Spin: The drum does not spin after the final drain process. Soil: Tap to change the soil level for the current cycle. Detergent: You can select the amount of the detergent to be dispensed during each wash cycle. Softener: You can select the amount of the softener to be dispensed during each wash cycle. Extra Rinse: Adds an additional rinse at the end of the cycle to remove laundry additives more thoroughly. <ul style="list-style-type: none"> Tap to turn on or off this function. Bubble Soak: This function helps remove a wide variety of stubborn stains. With Bubble Soak selected, laundry is thoroughly soaked in water bubbles for effective washing. <ul style="list-style-type: none"> Tap to turn on or off this function.

	Dryer (Dry Options)	<p>This icon appears during a dry-only cycle or a drying process. You can tap this icon to change the cycle settings.</p> <p>Tap the desired button to change the default dry cycle settings.</p> <ul style="list-style-type: none"> • Dryness: Tap to change the dry level. You can select from 4 different levels, but the available level depends on the selected cycle. • Dry Time: Tap to change the cycle time. <ul style="list-style-type: none"> - Some cycles do not support a time setting. - You can set the drying time between 20 minutes and 240 minutes. However, available drying time depends on the selected cycle. • Dry Prep: After the washing process is complete and before the drying process begins, the Laundry Combo pauses and alerts the user to remove items unsuitable for drying. <ul style="list-style-type: none"> - If you do not tap the pop-up message within the waiting period, the drying process will start automatically after waiting for 10 minutes. - Dry Prep is only available for the cycles that include both washing and drying process. • Wrinkle Prevent: Reduces wrinkles by rotating the drum intermittently after completing the dry cycle. Wrinkle Prevent provides approximately 180 minutes. The load is dry and can be removed at any time during the Wrinkle Prevent cycle. <ul style="list-style-type: none"> - Tap to turn on or off this function.
	Washer and Dryer	This set of icons appears to show that you can set or have already set the wash and dry cycle settings.
	Auto open door	This icon indicates that the Auto open door function is on.
	Start	You can start the operation.
	Pause	You can pause the operation. <ul style="list-style-type: none"> • During the operation, tap the button to pause.

Operations

Operating a cycle

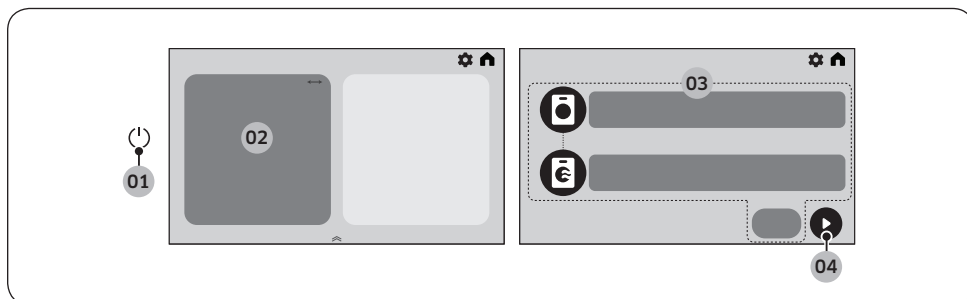

1. Tap to turn the power on.
2. Select the desired cycle.
 - For more information on **Cycle overview**, see page **43**.
3. Change the default cycle options.
 - For the washing process, tap **Temp.**, **Spin**, **Soil**, **Detergent**, **Softener**, **Extra Rinse**, or **Bubble Soak** to change the default cycle settings.
 - For the drying process, tap **Dryness**, **Dry Time**, **Dry Prep**, or **Wrinkle Prevent** to change the default cycle settings.
 - You cannot set the Dry Time for the Time Dry and Air Fluff cycle.
 - You can select a wash-only cycle or dry-only cycle by tapping the or .
 - You can set the Delay End function.
 - Not all cycles have additional functions available.
4. Tap to start the operation.
 - Once you set the cycle you want, the screen displays brief cycle descriptions and cycle duration. You can also check the cycle progress, remaining cycle time, and information codes.

NOTE

- To change the cycle, tap **View All Cycles**, and then select the desired cycle.
- After the dry cycle ends, the clothes may feel slightly damp or cool to the touch. This is because the combo is designed to dry clothes at low heat in a sealed drum. However, you don't need to worry as the clothes will feel completely dry once you take them out of the drum and shake them.

Cycle overview

Cycle descriptions

You can add or delete cycles to personalize the cycle list in the My cycles option. See page for more information.

NOTE

- Energy savings will vary depending on loads and cycles. Energy consumption could increase if the LCD screen is set to stay on all year long.
- If you have finished the wash cycle with a lower Spin setting, the laundry might not be fully dried after the dry cycle. In this case, run the Time Dry cycle additionally.
- To ensure even drying results, you may need to reposition the items in the drum.
- Use the Towels cycle if you need to dry only the towels.

Wash+Dry cycles

Cycle	Description
Normal	<ul style="list-style-type: none">• For cottons, bed linens, table linens, underwear, towels, or shirts. The washing time and the rinse count are automatically adjusted according to the load.• Default energy cycle for drying: Normal<ul style="list-style-type: none">- To access the Normal cycle on the LCD models, turn on the power, and select Cycle > Normal.
AI Opti Wash & Dry	<ul style="list-style-type: none">• The Laundry Combo detects the type, weight, and soil level of your laundry, and then selects the wash cycle settings accordingly. For example, the Laundry Combo will add more detergent*, washing time, and rinse count if your laundry is heavily soiled, and it will select appropriate settings to handle delicate items.<ul style="list-style-type: none">- *: We recommend enabling the Auto Dispense function if you use the AI Opti Wash & Dry cycle. Enable the Auto Dispense function if you want the Laundry Combo to adjust the detergent amount automatically according to the soil level of your laundry.- Based on internal testing using the AI Opti Wash & Dry cycle on an IEC 8 lb load. A turbidity sensor operates for all weight while fabric sensing operates for 8lb and under. Actual results may vary depending on individual use.
Super Speed	<ul style="list-style-type: none">• The shortened time may differ depending on the load/options.• For best performance, recommended load is 10 lb (4.5 kg) or lower.
Heavy Duty	<ul style="list-style-type: none">• For sturdy, colorfast fabrics and heavily soiled items.
Small Load	<ul style="list-style-type: none">• For lightly soiled items that you want to finish washing quickly.• For best performance, recommended load is 4 lb (2.0 kg) or lower.

Operations

Cycle	Description
Tide POD Cold	<ul style="list-style-type: none"> The Tide POD Cold cycle provides deep cleaning as the detergent dissolves effectively even in cold water. Appropriate for the household laundry loads when used with Tide Power PODs.
Delicates	<ul style="list-style-type: none"> For sheer fabrics, bras, lingerie (silk), and other handwash-only fabrics. Using specialty detergent in the Aqua Pebble or Flex auto dispenser is recommended.
Steam Whites	<ul style="list-style-type: none"> For white items. You can wash with or without bleach.
Steam Sanitize	<ul style="list-style-type: none"> For colorfast fabrics and heavily soiled laundry, this cycle heats the supplied water over 60 °C (140 °F) to clean deeply. If you stop running the cycle while the Laundry Combo is heating the water, the door remains locked for your safety.
Steam Normal	<ul style="list-style-type: none"> For washing everyday garments with steam.
Towels	<ul style="list-style-type: none"> For bath towels, washcloths, and mats.
Bedding	<ul style="list-style-type: none"> For bulky items such as comforters, blankets, and sheets. For best results, wash only 1 type of bedding. For bulky items, use liquid detergent and do not roll the items in the drum because they might get stuck in the drum.
Activewear	<ul style="list-style-type: none"> For exercise wear such as sports jerseys, training pants, shirts/tops and other performance clothing. This cycle provides effective soil removal with controlled drum rotation for special fabric care. Using specialty detergent in the Aqua Pebble or Flex auto dispenser is recommended.
Wool	<ul style="list-style-type: none"> Specific for machine-washable wool for loads less than 4 lb (2.0 kg). The Wool cycle features fine pulsating and soaking to protect the wool fibres from shrinkage/distortion. Using specialty detergent in the Aqua Pebble or Flex auto dispenser is recommended.
Colors	<ul style="list-style-type: none"> This cycle washes items in low-temperature water to prevent discoloration.
Perm Press	<ul style="list-style-type: none"> For wash-and-wear, synthetic fabrics, and lightly to normally soiled items.
Eco Cold	<ul style="list-style-type: none"> For normally and lightly soiled items. This cycle uses only cold water to save energy. Cold water also helps prevent fabric damage.
Less Microfiber	<ul style="list-style-type: none"> Use this cycle to reduce the amount of microfibers generated during washing synthetic clothes.

Cycle	Description
Spin Only	<ul style="list-style-type: none"> To perform the spin process only.
Rinse+Spin	<ul style="list-style-type: none"> Features an additional rinse process after fabric softener is applied to the laundry.

Dry cycles

Cycle	Description
Time Dry	<ul style="list-style-type: none"> You can set the cycle time from 20 minutes to 250 minutes.
Air Fluff	<ul style="list-style-type: none"> Tumbles the load in room temperature air.

Product Care cycles

Cycle	Description
Product Care	Self Clean+ (Wash cycle) <ul style="list-style-type: none"> Cleans the drum by removing dirt and build-up from the drum. Perform once every 30 washes. Make sure the drum is empty.
	Self Dry (Dry cycle) You can sterilize the drum to maintain its cleanliness. <ul style="list-style-type: none"> An alert message to perform the Self Dry cycle appears after every 40 uses. Use this cycle regularly to dry inside the drum and prevent odor.

Operations

Cycle chart

Use this chart to set the best cycle and options for your laundry.

Wash Cycle chart

● : factory setting, ○ : can be selected

Cycle	Functions				
	Temp.				
	Extra Hot	Hot	Warm	Cold	Tap Cold
Normal	○	○	●	○	○
AI Opti Wash & Dry		○	●	○	○
Super Speed		○	●		
Heavy Duty	○	●	○	○	○
Small Load		○	●	○	○
Tide POD Cold				○	●
Delicates			○	○	●
Steam Whites		●			
Steam Sanitize	●				
Steam Normal		●			
Towels		○	●	○	○
Bedding			●	○	○
Activewear			●	○	○
Wool			●	○	○
Colors				●	
Perm Press			●	○	○
Eco Cold				○	●
Less Microfiber				○	●
Spin Only					
Rinse+Spin					
Self Clean+	●				

Cycle	Functions										
	Spin										
	Wash Only						Wash & Dry				
	Extra High	High	Medium	Low	Extra Low	No Spin	No Drain	Extra Hot	High	Medium	Low
Normal	○	●	○	○	○	○	○	●			
AI Opti Wash & Dry	○	●	○	○	○	○	○	●			
Super Speed	○	●	○	○	○	○	○	●			
Heavy Duty	●	○	○	○	○	○	○	●			
Small Load	●	○	○	○	○	○	○	●			
Tide POD Cold	○	●	○	○	○	○	○	●			
Delicates			●	○	○	○	○			●	
Steam Whites	○	●	○	○	○	○	○	●			
Steam Sanitize	○	●	○	○	○	○	○	●			
Steam Normal	○	●	○	○	○	○	○	●			
Towels	○	●	○	○	○	○	○	●			
Bedding			○	●	○	○	○	●			
Activewear			○	●	○	○	○			●	
Wool				●	○	○	○				●
Colors	○	●	○	○	○	○	○	●			
Perm Press		○	○	●	○	○	○	●			
Eco Cold	○	●	○	○	○	○	○	●			
Less Microfiber			○	●	○	○	○	●			
Spin Only	○	●	○	○	○	○		●			
Rinse+Spin	○	●	○	○	○	○	○	●			
Self Clean+	●								●		

Operations

Cycle	Functions						
	Soil level					Bubble Soak	Extra Rinse
	Extra Heavy	Heavy	Normal	Light	Extra Light		
Normal	○	○	●	○	○	○	○
AI Opti Wash & Dry			●			○	○
Super Speed	○	○	●	○	○		○
Heavy Duty	●	○	○	○	○	○	○
Small Load	○	○	○	○	●		○
Tide POD Cold	○	○	●	○	○	○	○
Delicates	○	○	●	○	○		○
Steam Whites	○	○	●	○	○	○	○
Steam Sanitize	○	○	●	○	○	○	○
Steam Normal	○	○	●	○	○	○	○
Towels	○	○	●	○	○	○	○
Bedding	○	○	●	○	○	○	○
Activewear	○	○	●	○	○	○	○
Wool			●				
Colors	○	○	●	○	○	○	○
Perm Press	○	○	●	○	○	○	○
Eco Cold	○	○	●	○	○	○	○
Less Microfiber	○	○	●	○	○	○	
Spin Only							
Rinse+Spin							○
Self Clean+			●				

Dry Cycle chart

NOTE

For best results, follow the load size recommendations for each dry cycle.

- Large load: Fill the drum to about $\frac{3}{4}$ full. Do not add items over this level as they need to tumble freely.
- ◐ Medium load: Fill the drum to about $\frac{1}{2}$ full.
- Small load: Fill the drum with 3-5 items, not more than $\frac{1}{4}$ full.

Cycle	Recommended items	Load size	Dry level
Normal	Cotton, mixed loads of cotton and synthetic fabrics	●	Normal
AI Opti Wash & Dry	Cotton, mixed loads of cotton and synthetic fabrics	●	Normal
SuperSpeed	Synthetic fabrics	◐	Normal
Heavy Duty	Heavy fabrics such as jeans, corduroys, heavy work clothes	◐	Normal
Small Load	Small loads	○	Normal
Tide POD Cold	Cotton, mixed loads of cotton and synthetic fabrics	●	Normal
Delicates	Underwear, lingerie	○	Less
Steam Whites	Cotton, mixed loads of cotton and synthetic fabrics	●	More
Steam Sanitize	Bedding, curtains, children's clothing	●	More
Steam Normal	Cotton, mixed loads of cotton and synthetic fabrics	●	More
Towels	Bath towels and similar items	●	Normal
Bedding	Blankets, sheets, comforters, pillows	●	Normal
Activewear	Exercise wear, sports jerseys	◐	Less
Wool	For machine washable and tumble dryable wool only	○	Damp
Colors	Cotton, mixed loads of cotton and synthetic fabrics	●	Normal
Perm Press	Wrinkle-free cotton, synthetic fabrics	◐	Less
Eco Cold	-	●	Normal
Less Microfiber	The drying process is off as a default setting.	-	-
Time Dry	Any load	●	-
Air Fluff	All types of fabric	○	-
Self Dry	-	-	-

Operations

● : factory setting, ○ : can be selected



Cycle	Functions						
	Dryness				Dry Time	Dry Prep	Wrinkle Prevent
	More	Normal	Less	Damp			
Normal	○	●	○	○		○	○
AI Opti Wash & Dry	○	●	○	○		○	○
Super Speed	○	●	○	○		○	○
Heavy Duty	○	●				○	○
Small Load	○	●	○	○		○	○
Tide POD Cold	○	●	○	○		○	○
Delicates		○	●	○		○	○
Steam Whites	○	●	○	○		○	○
Steam Sanitize	●					○	○
Steam Normal	○	●	○	○		○	○
Towels	○	●				○	○
Bedding	○	●				○	○
Activewear		○	●	○		○	○
Wool				●		○	
Colors	○	●	○	○		○	○
Perm Press		○	●	○		○	○
Eco Cold	○	●	○	○		○	○
Less Microfiber	○	●	○	○		○	○
Time Dry					○	○	○
Air Fluff					○	○	○
Self Dry					○		

Settings

Using Settings

1. Tap .
2. Tap **General** or **Washer**.
3. Scroll through the screen to select the desired menu.
4. Change the settings or start the function.

NOTE



- To return to the Home screen, tap  on the top left corner, or  on the top right corner of the screen.
- If the selected function is not supported, the "**Currently not supported**" message is displayed, and the **OK** button is not activated.
- When you select an additional function, a brief help message appears for the first ten times of use.

Settings menu description

General

Options	Descriptions
Samsung account	You can log in to your Samsung account or create a new Samsung account.
Connections	<p>You can turn the Wi-Fi on or off. You can also start the Smart Control function.</p> <ul style="list-style-type: none">• Wi-Fi: Tap to turn on or off the Wi-Fi.<ul style="list-style-type: none">- The Laundry Combo's Wi-Fi is off as a factory default setting. However, the Laundry Combo's Wi-Fi turns on automatically when you turn on the Laundry Combo for the first time. Then, the final Wi-Fi setting is maintained regardless of the Laundry Combo power status.- Once you turn on the Laundry Combo's Wi-Fi and connect to a network, the Laundry Combo remains connected to the network even when you turn off the power.- The Wi-Fi indicates that the Laundry Combo is connected to the router through the Wi-Fi connection.• Easy Connection: You can easily install the SmartThings app using the displayed QR code on the screen.<ul style="list-style-type: none">- You can connect to the SmartThings app and control your Laundry Combo remotely.

Operations



Options	Descriptions
Lock	<p>You can lock the control of the Laundry Combo to prevent children or infants from accidentally starting or setting the Laundry Combo.</p> <ul style="list-style-type: none"> • When Lock is enabled, the touch screen and the door become locked for safety. • You can enable/disable Lock in any selected cycle. • Press and hold the Unlock button for 3 seconds to unlock. <p> NOTE</p> <ul style="list-style-type: none"> • If you want to put additional items into the Laundry Combo while Lock is enabled, you must disable the Lock function first. • You cannot open the door after a wash cycle when the Lock is on. Disable the function first, and then open the door and take out the laundry. <ul style="list-style-type: none"> - Turn on the power, tap  > General > Lock and set the function to Off. Then, you will be able to open the door.
Sounds	<p>You can set the Sound mode, Sound theme, Volume, and Voice style.</p> <ul style="list-style-type: none"> • Sound mode: You can set the desired Sound mode from Voice, Tone, and Mute. <ul style="list-style-type: none"> - If you set the Sound mode to Mute, the alert sound will not be turned off for safety purposes. • Sound theme: You can select the desired Sound theme. Tap a theme once to preview the sound. • Volume: You can adjust the volume for system and media sounds. <ul style="list-style-type: none"> - Sound mode will automatically change to Voice if you adjust the volume while the Sound mode is set to Mute. • Voice style: You can select the desired Voice style. Tap a style once to preview the sound.
Home device notifications	<p>You can turn on or off the notifications for your home devices registered on the SmartThings app.</p>
Display	<p>You can set the Brightness and Font size.</p>
Display and style	<p>You can set the Screen theme.</p>

Options	Descriptions
Bixby	<p>You can set the Voice wake-up and Sound feedback options.</p> <p> NOTE</p> <ul style="list-style-type: none"> The microphone for voice recognition is built into the Laundry Combo's worktop. <ul style="list-style-type: none"> The best way to use the voice recognition function is to stand within 3 feet (1 meter) of the Laundry Combo, reduce any background noise, and speak loudly and clearly at a steady pace toward the built-in microphone. The voice recognition function may not work if you stand more than 3 feet (1 meter) away or if you speak too softly.
Microphone	You can enable or disable the use of the microphone.
Language	You can change the system language.
Date and time	You can set the time and date automatically or manually and set the desired time format.
Liquid units	You can select the liquid units.
Accessibility	<p>You can set the TalkBack and Visibility enhancements settings.</p> <ul style="list-style-type: none"> TalkBack: Enable this feature to receive voice feedback from your Laundry Combo. Visibility enhancements: You can change the High contrast and Text size settings to enhance the visibility.
Software update	You can download and install the latest version of the software. Download begins automatically when the Laundry Combo is connected to Wi-Fi.
Support	<p>You can check the user guide or start the remote support service.</p> <ul style="list-style-type: none"> Get remote support for all your needs related to your appliance.
Reset	<p>You can reset network settings or reset all settings.</p> <ul style="list-style-type: none"> Reset network settings: Turn on the power, tap Settings - General - Reset - Reset network settings - Reset in that order. <ul style="list-style-type: none"> This will reset the Wi-Fi and SmartThings connection settings. Reset all settings: Turn on the power, tap Settings - General - Reset - Reset all settings - Reset in that order. <ul style="list-style-type: none"> This will reset all the settings, including network settings and personal data. Your Laundry Combo resets to the factory setting. Restart: Restart the device.
About device	You can check the information of the Laundry Combo such as Status and Legal information.

Operations

Washer

Options	Descriptions
Drum light	This turns on the light inside the drum so you can check the status of the items inside.
Auto dispensers	<p>You can select the dispenser mode and set the detergent type, concentration, and amount setting. The Laundry Combo automatically dispenses an adequate amount of detergent for the selected cycle.</p> <ul style="list-style-type: none"> • Dispenser mode: You can select the Dispenser mode. The default setting is General detergent and Softener. <ul style="list-style-type: none"> - You can select General detergent and Softener, General detergent and Specialty detergent, or General detergent and General detergent. • Detergent type <ul style="list-style-type: none"> - Auto dispenser: You can only select General detergent. - Flex auto dispenser: You can set this dispenser to dispense detergent (General detergent, Specialty detergent) or softener. • Concentration: You can change the concentration level. <ul style="list-style-type: none"> - 1x > 2x > 3x - The default setting is 1x. • Amount: You can select the amount of the detergent to be dispensed during each wash cycle. <ul style="list-style-type: none"> - Low > Medium > High - The default setting is Medium. <p> NOTE</p> <ul style="list-style-type: none"> • You can enable and disable automatic detergent dispensing and set the detergent amount to be dispensed for each cycle. You must put detergent manually if you disable the automatic detergent dispensing. • For the cycles that require the use of special detergent, only the available options are displayed.

Options	Descriptions
<p>Pump clean</p>	<p>You can use this function to clean detergent or softener residue buildup in the pump.</p> <p>Use this function after you empty and clean the dispenser.</p> <ul style="list-style-type: none"> You can select from Auto dispenser, Flex auto dispenser, or Auto dispenser/Flex auto dispenser. <ul style="list-style-type: none"> Pour water up to the MAX line in the dispenser, and then tap Start cleaning. <p> NOTE</p> <p>During the pump cleaning process, the drum rotates to drain water. When the pump cleaning process is complete, the water inside the dispenser(s) will drain automatically.</p>
<p>Auto open door</p>	<p>You can set the Laundry Combo door to open automatically after the cycle is finished.</p> <ul style="list-style-type: none"> The default setting is Open immediately. However, if you perform only the washing process, the Open 5 mins later setting applies. You can select from Open 5 mins later, or Open immediately. <p> NOTE</p> <ul style="list-style-type: none"> Available options for the Auto open door function are active only when the function is on. The options are inactive when the function is off. The Auto open door function does not work when Lock is enabled. The door will not open at the end of the cycle if you have enabled the Stay Connect function in the SmartThings app.
<p>AI pattern</p>	<p>This function saves frequently used cycles and settings. When you turn the function on, the Laundry Combo remembers the cycles you use most and their settings (Wash cycles: Temp., Spin, and Soil / Dry cycles: Dryness and Dry Time) and displays them in frequency order.</p> <ul style="list-style-type: none"> The default setting is On. Set it to Off if you do not want to use this function. When you turn off the function, all the saved data resets.
<p>My cycles</p>	<p>Add or remove cycles to create a personal cycle list.</p> <ul style="list-style-type: none"> You can only edit a cycle to create a personal cycle when the Laundry Combo is not operating. <p> NOTE</p> <ul style="list-style-type: none"> The Normal and Product Care cycle cannot be removed from the list of cycles. You can also edit My cycles in the SmartThings app.

Operations

Options	Descriptions
Calibration	<p>You can run calibration again for accurate weight detection.</p> <ul style="list-style-type: none">• Calibration does not start if the door is not closed properly.• The drum rotates clockwise and counterclockwise for about 3 minutes.
Self diagnosis	<p>You can use this function to check for abnormal signs on your Laundry Combo.</p> <ul style="list-style-type: none">• If the Laundry Combo detects an error, an information code and solution is displayed on the LCD panel.

Delay End

You can set the Laundry Combo to finish your wash automatically at a later time, choosing a delay of between 5 hours to 24 hours.



1. Select a cycle and change the cycle settings as necessary.
2. Tap **Delay End** at the bottom of the Cycle screen.
3. Set the desired end time, and then tap **OK**.
 - Status shows in the display and the Laundry Combo tumbles the drum to sense the weight of the load (if load sensing is preset for the selected cycle). When load sensing is complete, the display shows the remaining time until the end of the wash cycle.
 - The time at which the operation ends may vary depending on the amount and condition of the laundry items.
 - To cancel Delay End, tap **Stop** to restart the Laundry Combo.

Special features

Smart Control

You can connect to the SmartThings app and control your Laundry Combo remotely.

Connecting your Laundry Combo

1. Download and open the SmartThings app on your smartphone or tablet (Android & iOS).
2. Tap  to turn on the Laundry Combo.
3. Tap and hold .
 - a. The Laundry Combo enters AP mode and connects to your smartphone or tablet.
 - b. Tap  to authenticate your Laundry Combo.
 - c. Once the authentication process is complete, your Laundry Combo is successfully connected to the app.
 - You can use various features available in the SmartThings app.

NOTE

- If your Laundry Combo fails to connect with the SmartThings app, try again.
- Check your router if you experience any Internet connection problem after connecting your Laundry Combo with the SmartThings app.
- If the Wi-Fi is off, tap and hold  > **Connections**, and then turn the Wi-Fi on.
- Turning the Laundry Combo's Wi-Fi on allows you connect to the Laundry Combo through the SmartThings app on your smartphone or tablet, regardless of the power status of the Laundry Combo. However, the Laundry Combo appears offline on the SmartThings app if the Laundry Combo's Wi-Fi is off.
- Close the door before starting the Smart Control function.
- If you use your Laundry Combo for a while without connecting it to the SmartThings app, a pop-up message about Smart Control will show for 3 seconds on 20th, 40th, and 60th use.
- If the Laundry Combo's Wi-Fi is not connected to an AP (access point), the Wi-Fi will turn off when you turn of the power.

Stay Connect

Set up the Stay Connect function in your SmartThings app to keep Smart Control turned on at the end of a cycle. Your Laundry Combo stays connected to the app so you can send additional instructions, whether you are at home or away.

1. If you turn on the Stay Connect function on the SmartThings app, the Laundry Combo will stay in standby power saving mode after completing a cycle.
 - The Stay Connect function will remain active for up to 24 hours if the door remains closed.
2. When the Stay Connect function is active, the Smart Control, Door Lock, and Wi-Fi icons are illuminated on the LCD display.
3. You can conveniently control your Laundry Combo, adding rinse, spin cycles using the SmartThings app.

Operations

NOTE

- The Laundry Combo switches to standby power saving mode when operation is paused even if the machine is not connected to the SmartThings app.
- In some circumstances, only the Door Lock icon may be illuminated.

SmartThings

Wi-Fi connection

On your smartphone or tablet, go to **Settings** and turn on the wireless connection and select an AP (Access Point).

- This appliance supports the Wi-Fi 2.4 GHz protocols.

Download

On an app market (Google Play Store, Apple App Store, Samsung Galaxy Apps), find the SmartThings app by searching for "SmartThings". Download and install the app on your device.

NOTE

The app is subject to change without notice for improved performance.

Log in

You must first log into SmartThings with your Samsung account. To create a new Samsung account, follow the instructions on the app. You don't need a separate app to create your account.

NOTE

If you have a Samsung account, use the account to log in. A registered Samsung smartphone or tablet user automatically logs in.



To register your appliance to SmartThings

1. Make sure your smartphone or tablet is connected to a wireless network. If not, go to **Settings** and turn on the wireless connection and select an AP (Access Point).
2. Open **SmartThings** on your smartphone or tablet.
3. If a message of "A new device is found.", select **Add**.
4. If no message appears, select **+** and select your appliance in a list of devices available. If your appliance is not listed, select **Device Type > Specific Device Model**, and then add your appliance manually.
5. Register your appliance to the SmartThings app as follows.
 - a. Add your appliance to SmartThings. Make sure your appliance is connected to SmartThings.
 - b. When registration is complete, your appliance appears on your smartphone or tablet.

If you're moving out, we recommend you completely wipe the appliance and do a network reset on it before you leave it behind.

If you're moving in, the easiest way to take control and remove the previous user's access is to add it to SmartThings yourself. But if you don't plan on using SmartThings, a network reset should be performed to protect your privacy. In rental properties, there's a regular change of ownership. To ensure resident privacy, Wi-Fi and/or other connectivity settings should be reset at each change of resident. Please refer to factory reset instructions in this manual.



Maintenance

Keep the Laundry Combo clean to prevent deteriorated performance and to preserve its life cycle.

WARNING

- Certain internal parts are intentionally not grounded and may present a risk of electric shock only during servicing. Service personnel – Do not contact the following parts while the appliance is energized: Control board, heat sink, motor, inlet valve and pump.
- Sharp Edges - To reduce the risk of injury, use care when cleaning the condenser or evaporator coil fins.

Product Care

The Product Care screen offers maintenance tips to keep your Laundry Combo clean and prolong the product life cycle.

You can check the remaining number of cycles until the next Self Clean+ and Self Dry duration, and start the Self Clean+ or Self Dry cycle.

NOTE

If the Product Care cycle needs to be performed, a guide message will appear on the Home screen. Follow the on-screen instructions to run the Self Clean+ or Self Dry cycle.

1. On the Home screen tap **Product Care** to move to the Product Care screen.
2. Tap **Clean now** or **Start cleaning** under the desired option to start the care cycle.
 - All the options for the Product Care cycle are set automatically.
 - If both the drum and the heat exchanger require cleaning, all the necessary options for the Product Care cycle are set automatically.
3. Tap  to move to the Home screen.

Self Clean+

Certain usage and environmental conditions may result in some residue build-up or odor in the drum. To prevent this build-up or odor and keep the drum fresh and clean, perform the Self Clean+ cycle at least once a month or every 40 cycles. Perform the recommended procedure below when using the Self Clean+ cycle.

1. Tap .
2. On the cycle screen, select **Product Care > Self Clean+**.
3. Tap **Clean now**.

CAUTION

If there is chlorine bleach left in the drum for an extended period of time, rust can occur.

NOTE

- The water temperature for Self Clean+ is defaulted to Extra Hot. This temperature cannot be changed.
- In the case where residue is present in the drum, add liquid chlorine bleach to the MAX level line in the Manual bleach compartment before starting the Self Clean+ cycle. Do not add the liquid chlorine bleach to the other compartments (This is only the case for Self Clean+ cycle).
- Do not exceed the max line. Do not use or mix any other detergent or chemicals during the Self Clean+ cycle. If necessary, run a Rinse+Spin cycle after the Self Clean+ cycle has completed to help remove any remaining residue.

Self Clean+ reminder

- After every 40 cycles, the Laundry Combo displays the "**Time to run Self Clean+ ▶ Press Clean now to start the Product care cycle.**" message for an hour to alert you to run the **Self Clean+** cycle.
- It is recommended to run the cycle regularly for hygienic purposes.
- You will see the **Self Clean+** alert message when the Laundry Combo completes a cycle. If you open the door, the message disappears, and the display shows the **Self Clean+** cycle setting screen automatically. At this time, the LCD panel displays the recommended drying cycle.
- The reminder will appear on the LCD panel for 5 additional consecutive cycles before turning off. The next reminder will not appear until another 40 cycles have been completed.

Maintenance

Self Dry

1. Tap .
2. On the cycle screen, select **Product Care > Self Dry**.
3. Tap **Clean now**.
 - When you start the Self Dry cycle, the calibration process is included in the cycle to enable more precise weight detection.
 - If you leave the door open after the Self Dry cycle is completed, it helps maintain hygiene inside the Laundry Combo.
 - After every 30 uses, an alert message to perform the Self Dry cycle appears. Use this cycle regularly to dry inside the drum and prevent odor.

 **CAUTION**

Make sure to empty the drum before using this cycle.

Emergency drain

In case of a power failure, drain the water inside the drum before taking out the laundry.

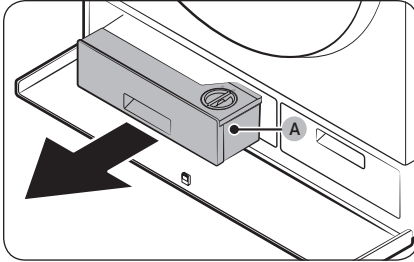

1. Power off and unplug the Laundry Combo from the electrical outlet.
2. Press the Compartment cover to open it.
3. Pull out the **Auto dispenser (A)**.

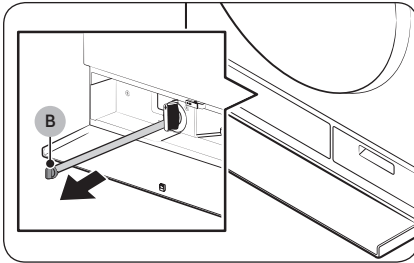

4. Put an empty, spacious container around the cover, and stretch the emergency drain tube to the container while holding the **tube cap (B)**.

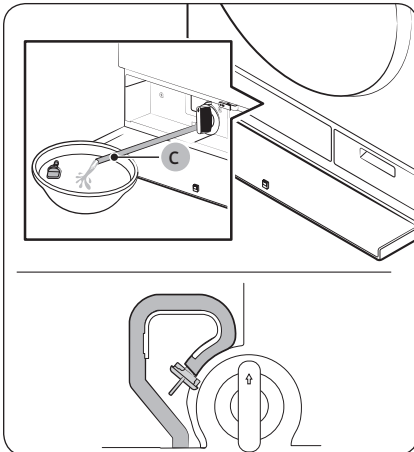

5. Open the tube cap and let water in the **emergency drain tube (C)** flow into the container.
6. When done, close the tube cap, and reinsert the tube. Then, close the filter cover.

Maintenance

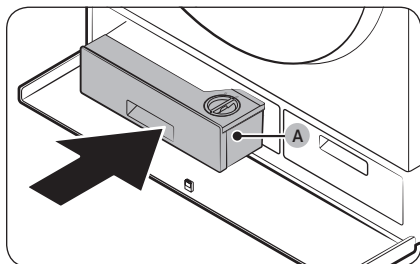

7. Insert the **Auto dispenser (A)** back into the place.
8. Close the Compartment cover.

NOTE

Use a spacious container because the water in the drum may be more than expected.

Cleaning

Surface of the Laundry Combo

Use a soft cloth with a nonabrasive household detergent. Do not spray water onto the Laundry Combo.

Mesh filter

Clean the mesh filter of the water hose once or twice a year.

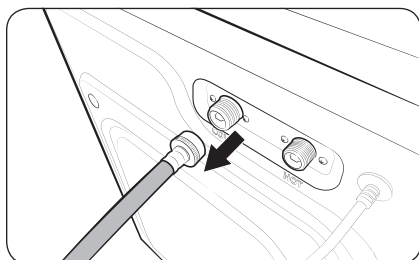

1. Turn off the Laundry Combo, and unplug the power cord.
2. Close the water tap.
3. Loosen and disconnect the water hose from the back of the Laundry Combo. Cover the end of each hose with a cloth or towel to prevent water from gushing out.

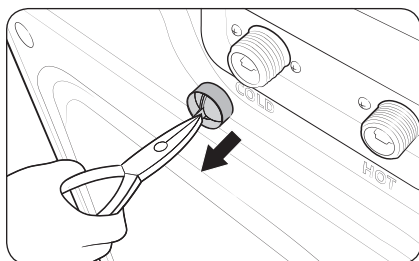

4. Use pliers to pull out the mesh filter from the inlet valve.
5. Submerge the mesh filter deeply in water so that the threaded connector is also submerged.
6. Dry the mesh filter completely in the shade.
7. Reinsert the mesh filter into the inlet valve, and reconnect the water hose to the inlet valve.
8. Open the water tap.

NOTE

- If the mesh filter is clogged, an information code of "4C" appears on the screen.
- Clean the mesh filter of the water hose more frequently if water is provided by an aged water system or well.

Maintenance

Drain filter

It is advisable to clean the drain filter every 2 months to prevent its clogging.

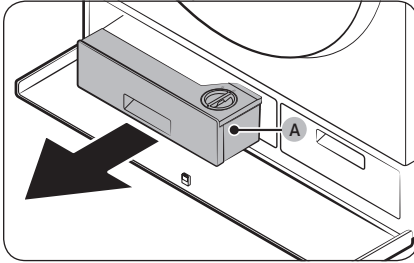

1. Turn off the Laundry Combo, and unplug the power cord.
2. Drain the remaining water inside the drum. (For more information, see the **Emergency drain** section on page 63.)
3. Press the Compartment cover to open it.
4. Pull out the **Auto dispenser (A)**.

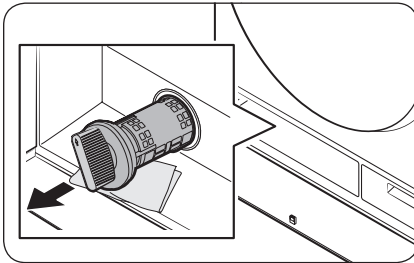

5. Turn the drain filter knob to the left, and drain off the remaining water.

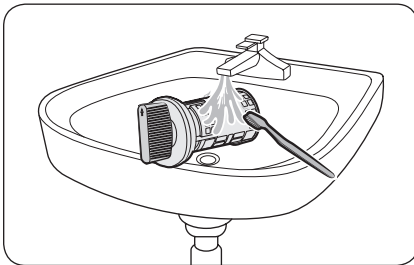

6. Clean the drain filter using a soft brush. While the drain filter is removed, make sure the impeller inside the drain pump is free of debris.

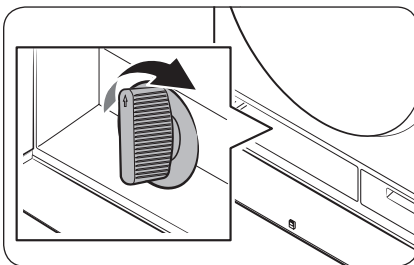

7. Reinsert the drain filter, and turn the filter knob to the right.

NOTE

Some drain filters feature a safety knob that is designed to prevent accidents by children. To open the safety knob of the drain filter, push in and turn it to the left. The spring mechanism of the safety knob helps open the filter.

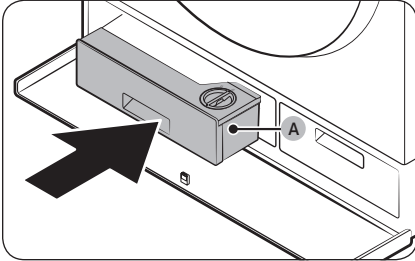

8. Insert the **Auto dispenser (A)** back into the place.
9. Close the Compartment cover.

 **NOTE**

If the drain filter is clogged, an information code of "5C" appears on the screen.

 **CAUTION**

- Make sure the filter knob is closed properly after cleaning the filter. Otherwise, this may cause a leak.
- Make sure the filter is inserted properly after cleaning it. Otherwise, this may cause an operational failure or a leak.

Maintenance

Auto dispensers

To prevent the detergent residue buildup in the automatic dispensers, clean the dispensers and their components once or twice a month, and whenever you refill or change the detergent or softener.

⚠ CAUTION

- Make sure to turn off the Laundry Combo and unplug the power cord before cleaning.
- If you are not going to use the Laundry Combo for a long time, empty the dispensers and clean them thoroughly.

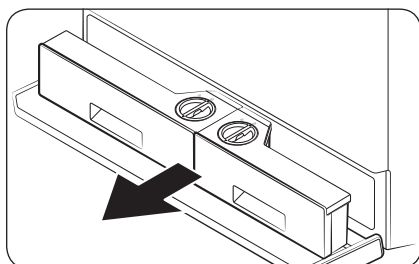

1. Press the Compartment cover to open it.
2. Pull out the Auto dispensers.

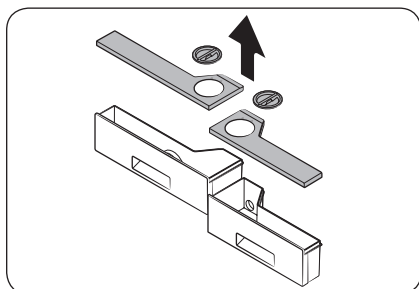

3. Remove the lids of both dispensers using the pull tabs at the back of each lid.

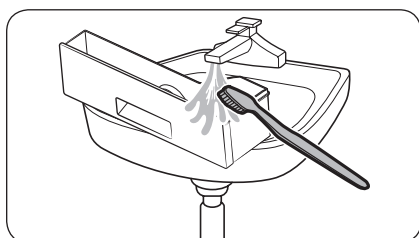

4. Clean the dispensers and all the other components under warm running water with a soft brush.
 - Wipe all components with a dry towel or cloth after cleaning

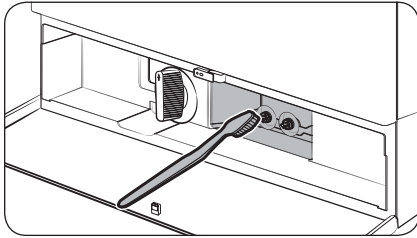

5. Clean the dispenser recess using a soft brush to remove detergent residues and limescale on the dispenser recess.

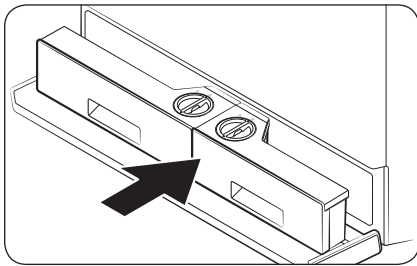

6. Push the Auto dispensers back into their positions.

⚠ CAUTION

- Make sure the dispenser recess is completely dry before inserting Auto dispensers.
- Tightly attach the tops of both dispensers before inserting them back.
- If the Compartment cover is not tightly closed, detergent may leak. Make sure the auto dispensers are fully pushed in.

7. Close the Compartment cover.

⚠ CAUTION

Do not spray water into the dispenser recess. It may cause electronic shock or fire.

Door diaphragm

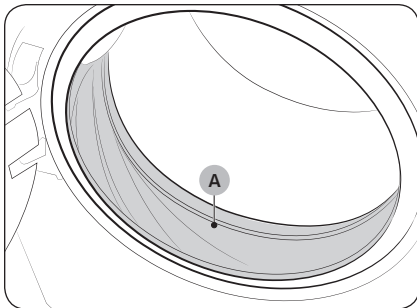

1. Open the door, and then empty the drum.
2. Combine 3/4 cups of liquid chlorine bleach and 1 gallon of warm tap water.
3. Wearing rubber gloves, use a soft, clean cloth dipped in the water and bleach solution to clean the diaphragm.
4. Let stand for 5 minutes, and then wipe up and dry well.

⚠ CAUTION

Use bleach carefully and be sure to follow the bleach manufacturer's use and care instructions.

Maintenance

Heat exchanger

A dirty heat exchanger will hinder the product's performance and should be cleaned regularly. An alert message appears every 180 uses to inform you to clean the heat exchanger. Clean the heat exchanger when you see the alert message.

NOTE

- Water droplets can form around the heat exchanger due to condensation caused by a temperature difference. This is normal and is not a sign of a leak.
- If you are not planning on using the Laundry Combo for a long period, open the Lint filter cover and ventilate.

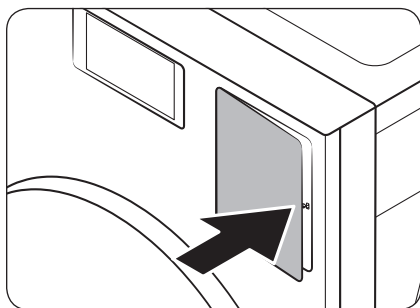

1. Press the right side of the Lint filter cover to open it.

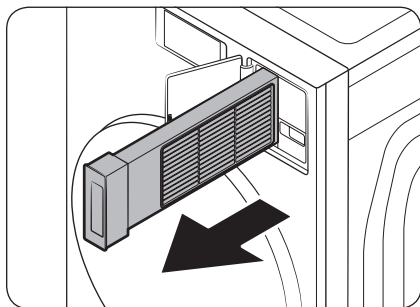

2. Pull out the lint filter.

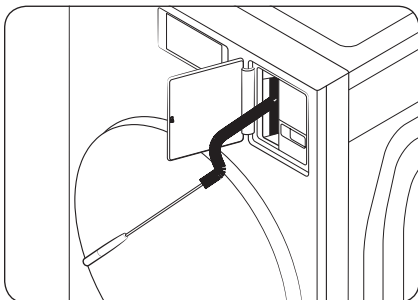

3. Clean the dust on the heat exchanger using the brush.
 - After cleaning with the brush, wipe off the remaining dust using a smooth, damp cloth.

⚠ CAUTION

- To avoid physical injury and burns, do not touch or clean the heat exchanger with bare hands.
- When cleaning the heat exchanger, be careful not to damage the fins.

📖 NOTE

If the heat exchanger is difficult to clean because it is completely dry, spray some water onto it and use a brush to clean it.

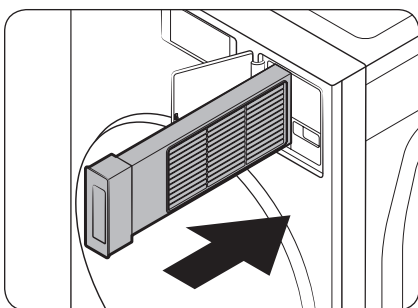

4. Insert the lint filter back into the place, and then close the Lint filter cover.

Maintenance

Lint filter

You must clean the lint filter every time after using the dry cycle. Not cleaning the lint filter could degrade the drying performance and affect the drying time.

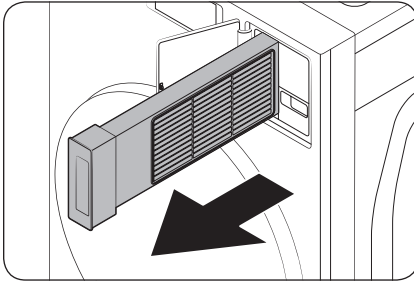

1. Open the Lint filter cover.
2. Pull out the lint filter.
 - Do not remove the rubber seal on the lint filter.

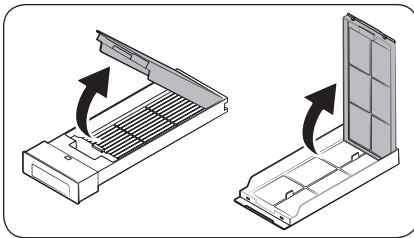

3. Open the outer filter, and then remove the inner filter.

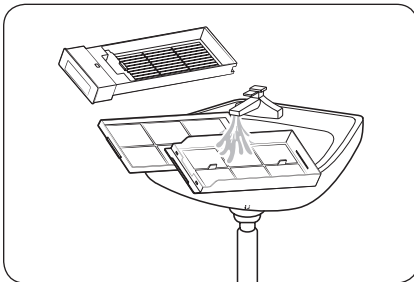

4. Remove lint on both inner and outer filters. Then, wash the filters in running water and completely dry the filters in a shade.

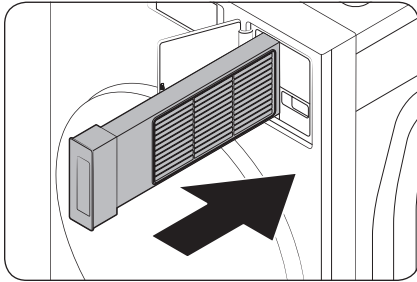

5. Put the inner filter into the outer filter in the correct direction.
6. Insert the assembled lint filter back into the place.

⚠ CAUTION

- Clean the lint filter after each load. Otherwise, the drying performance may decrease.
- If the filter surface is wet, allow it to completely dry before use.
 - Inserting the filter while it is wet may lead to the development of mold, unpleasant odors, or resulting in less efficient drying.
- When cleaning or removing the lint filter, do not shake or tap on the filter. Doing so can damage the filter.
- Opening the outer and inner filters carelessly and with excessive force can damage the filters.

📖 NOTE

Water droplets can form around the heat exchanger because of condensation caused by a temperature difference. This is normal and is not a sign of a leak.

Recovery from freezing

The Laundry Combo may freeze when the temperature in its location drops below 32 °F (0 °C).

1. Turn off the Laundry Combo, and then unplug the power cord.
2. Pour warm water over the water tap to loosen the water hose.
3. Disconnect the water hose, and then soak it in warm water.
4. Pour warm water into the drum and leave it for about 10 minutes.
5. Reconnect the water hose to the water tap.



📖 NOTE

If the Laundry Combo still doesn't operate normally, repeat the steps above.

Maintenance

Care for an extended period of non-use

Avoid leaving the Laundry Combo unused for an extended time. However, if you intend to leave the Laundry Combo unused for a long period of time, follow the directions below:

1. Tap .
2. On the cycle screen, select **Rinse+Spin**.
3. Empty the drum, and then tap and hold .
4. When the cycle is complete, close the water taps and disconnect the water hoses.
5. Turn off the Laundry Combo, and then unplug the power cord.
6. Open the door to let air circulate through the drum.

Cleaning the exterior

1. Turn off the water taps after finishing the day's washing.
This will shut off the water supply to your Laundry Combo and prevent the unlikely possibility of damage from escaping water. Leave the door open to allow the inside of your Laundry Combo to dry out.
2. Use a soft cloth to wipe up all detergent, bleach, or other spills as they occur. Clean the following as recommended below:
 - LCD panel – Clean with a soft, damp cloth. Do not use abrasive powders or cleaning pads. Do not spray cleaners directly on the panel.
 - Cabinet – Clean with soap and water.

CAUTION

Make sure to turn off the Laundry Combo and unplug the power cord before cleaning.

Cleaning the interior

Clean the interior of your Laundry Combo periodically to remove any dirt, soil, odor, mold, mildew, or bacterial residue that may remain in your Laundry Combo as a result of washing clothes.

CAUTION

Failure to follow these instructions may result in unpleasant conditions, including odors and/or permanent stains on your Laundry Combo or laundry.

NOTE

Hard water deposits may be removed, if needed. Use a cleaner labeled "Washer safe".

Troubleshooting

If a problem persists, contact a service center. The number of the service center is on the label attached to the product.

Checkpoints

If you encounter a problem with the Laundry Combo, first check the table below and try these suggestions.

Problem	Action
Does not start.	<ul style="list-style-type: none">• Make sure the Laundry Combo is plugged in.• Make sure the door is properly closed.• Make sure the water taps are open.• Tap  to start the Laundry Combo.• Make sure Lock is not activated.• Before the Laundry Combo starts to fill, it will make a series of clicking noises to check the door lock and will do quick drain.• Check the fuse or reset the circuit breaker.• Check if power is supplied properly.• Low voltage detected.<ul style="list-style-type: none">– Check if the power cord is plugged in.• Make sure laundry is not caught in the door.• Clean the filter.
Water supply is insufficient, or no water is supplied.	<ul style="list-style-type: none">• Fully open the water tap.• Make sure the door is properly closed.• Make sure the water supply hose is not frozen.• Make sure the water supply hose is not kinked or clogged.• Make sure there is sufficient water pressure.• Make sure that the cold water tap and the hot water tap are properly connected.• Clean the mesh filter as it may be clogged.
After a cycle, detergent remains in the detergent drawer.	<ul style="list-style-type: none">• Make sure the Laundry Combo is running with sufficient water pressure.• Make sure the detergent is added to the center of the detergent drawer.• Make sure the rinse cap is inserted properly.• If using granular detergent, make sure the detergent selector is in the upper position.• Remove the rinse cap and clean the detergent drawer.

Troubleshooting

Problem	Action
<p>Excessive vibrations or makes noise.</p>	<ul style="list-style-type: none"> • Make sure the Laundry Combo is installed on a level, solid floor that is not slippery. If the floor is not level, use the leveling feet to adjust the height of the Laundry Combo. • Make sure the shipping bolts are removed. • Make sure the Laundry Combo is not in contact with any other object. • Make sure the laundry load is balanced. • The motor can cause noise during normal operation. • Overalls or clothes with metallic decorations can cause noise while being washed. This is normal. • Metal objects such as coins can cause noise. After washing, remove these objects from the drum or filter case. • Redistribute the load. If only one item of clothing needs washing, such as a bathrobe or pair of jeans, the final spin result might be unsatisfactory, and an "Unbalanced laundry detected" check message will be shown in the display. • Remove any items stuck inside the lint filter.
<p>Does not drain and/or spin.</p>	<ul style="list-style-type: none"> • Make sure the drain hose is not kinked between the unit and drain system. If you encounter a drain problem, call for service. • Make sure the drain filter is not clogged. • Close the door and tap and hold ▷ . For your safety, the Laundry Combo will not tumble or spin unless the door is closed. • Make sure the drain hose is not frozen or clogged. • Make sure the drain hose is connected to a drain system that is not clogged. • If the Laundry Combo is not supplied with sufficient power, the Laundry Combo will temporarily not drain or spin. As soon as the Laundry Combo regains sufficient power, it will operate normally. • Make sure the drain hose is positioned correctly, depending on the connection type. • Clean the drain filter as it may be clogged.

Problem	Action
The door does not open.	<ul style="list-style-type: none"> • Tap ▷ to stop the Laundry Combo. • It may take a few moments for the door lock mechanism to disengage. • The door will not open until 3 minutes after the Laundry Combo has stopped or the power has been off. • Make sure all the water in the drum is drained. • The door may not open if water remains in the drum. Drain the drum and open the door manually. • Make sure the door lock light is off. The door lock light turns off after the Laundry Combo has drained. • Power Off and restart the unit.
Excessive suds.	<ul style="list-style-type: none"> • Make sure you use the recommended types of detergent as appropriate. • Use high efficiency (HE) detergent to prevent oversudsing. • Reduce the detergent amount for soft water, small loads, or lightly soiled loads. • Non-HE detergent is not recommended.
Cannot add additional detergent.	<ul style="list-style-type: none"> • Make sure the remaining amount of detergent and fabric softener is not over the limit.
Stops.	<ul style="list-style-type: none"> • Plug the power cord into a live electrical outlet. • Check the fuse or reset the circuit breaker. • Close the door, and tap and hold ▷ to start the Laundry Combo. For your safety, the Laundry Combo will not tumble or spin unless the door is closed. • Before the Laundry Combo starts to fill, it will make a series of clicking noises to check the door lock and will do quick drain. • There may be a pause or soak period in the cycle. Wait briefly, and the Laundry Combo may start. • Make sure the mesh filter of the water supply hose at the water taps is not clogged. Periodically clean the mesh filter. • If the Laundry Combo is not supplied with sufficient power, the Laundry Combo will temporarily not drain or spin. As soon as the Laundry Combo regains sufficient power, it will operate normally.

Troubleshooting

Problem	Action
Fills with the wrong water temperature.	<ul style="list-style-type: none"> • Fully open both taps. • Make sure the temperature selection is correct. • Make sure the hoses are connected to the correct taps. Flush water lines. • Make sure the water heater is set to supply a minimum of 49 °C hot water at the tap. Also, check the water heater capacity and recovery rate. • Disconnect the hoses and clean the mesh filter. The mesh filter may be clogged. • While the Laundry Combo fills, the water temperature may change as the automatic temperature control feature checks incoming water temperature. This is normal. • While the Laundry Combo fills, you may notice just hot and/or just cold water going through the dispenser when cold or warm temperatures are selected. This is a normal function of the automatic temperature control feature as the Laundry Combo determines the water temperature.
Load is wet at the end of a cycle.	<ul style="list-style-type: none"> • Use the High or Extra High spin speed. • Use high efficiency (HE) detergent to reduce oversudsing. • Load is too small. Small loads (one or two items) may become unbalanced and not spin completely. • Make sure the drain hose is not kinked or clogged.
Leaks water.	<ul style="list-style-type: none"> • Make sure the door is properly closed. • Make sure all hose connections are tight. • Make sure the end of the drain hose is correctly inserted and secured to the drain system. • Avoid overloading. • Use high efficiency (HE) detergent to prevent oversudsing. • Check the drain hose. <ul style="list-style-type: none"> - Make sure the end of the drain hose is not placed on the floor. - Make sure the drain hose is not clogged.
Items still wrinkled after Wrinkle Prevent (Wrinkle Away/Wrinkle Release)	<ul style="list-style-type: none"> • Small loads of 1 to 4 items work best. • Load fewer items. Load similar-type items. • Take out the items immediately after drying is complete.

Problem	Action
The clothes have lint on them.	<ul style="list-style-type: none"> • Always make sure the lint filter is clean before putting items into the Laundry Combo. When drying items that generate a large amount of lint, you may need to clean the lint filter in the middle of a cycle. • Some fabrics (such as white towels) causes more lint and should be dried separately from fabrics that lint attaches easily (such as black linen pants). • Check the inside of the pockets to make sure they are empty before drying.
Items are not dried.	<p>Check all of the above. Additionally:</p> <ul style="list-style-type: none"> • Do not overload the Laundry Combo. If the Laundry Combo is overloaded, it could take longer for items to dry. • Dry heavy fabrics separately from light fabrics. • The item(s) are too small and may not get enough spinning inside the drum. • Clean the filter. • Clean the heat exchanger. • If a drain hose is connected, make sure the water is draining properly.
Items are not dried evenly.	<ul style="list-style-type: none"> • Seams, pockets, and other parts of clothing are harder to dry than others. This is normal. • Sort heavy and light items separately.
Has odors.	<ul style="list-style-type: none"> • Excessive suds collect in recesses and can cause foul odors. • Run cleansing cycles to sanitise periodically. • Clean the door seal (diaphragm). • Do not attempt to dry wet items after leaving them in the Laundry Combo for a long time. • The Laundry Combo circulates ambient air inside and outside during the drying process to cool the system. Using the drying in a poorly ventilated area may, depending on the operating environment, raise the ambient humidity level and cause a damp, soggy smell to develop. Ensure proper ventilation when using the drying. • Dry the interior of the Laundry Combo after a cycle has finished.
A message appears on the display to alert that dispenser is open.	<ul style="list-style-type: none"> • Check if the detergent drawer is closed properly. <ul style="list-style-type: none"> - Open the detergent drawer and close it again. Make sure it's closed properly.

Troubleshooting

Problem	Action
The "Needs refill" message does not disappear after refilling the detergent/softener.	<ul style="list-style-type: none"> After refilling the Auto dispenser and Flex auto dispenser, close the detergent drawer, and then tap and hold ▷ . Then, the Laundry Combo will start to detect the detergent/softener, and the message will disappear. Depending on the type of detergent/softener, the message may not disappear immediately.
Detergent/softener is not dispensed.	<ul style="list-style-type: none"> Check if the Amount option for Auto dispenser or Flex auto dispenser is set to Off. The automatic dispensers do not dispense the detergent if the option is set to Off. Tap Settings, select Auto dispenser or Flex auto dispenser, and then change the Amount option. The automatic dispensers are disabled in the Delicates, Activewear, or Wool cycles. To dispense detergent in those cycles, tap Settings, select Auto dispenser or Flex auto dispenser, and then change the Amount option.
Excessive or insufficient amount of detergent/softener is dispensed.	<ul style="list-style-type: none"> Check the Amount option for Auto dispenser or Flex auto dispenser. Tap Settings, select Auto dispenser or Flex auto dispenser, and then change the Amount option.
Screen retention occurs while using the LCD screen.	<ul style="list-style-type: none"> When the temperature around the Laundry Combo is low, screen retention may occur while using the LCD. It will function normally when the temperature rises.

If a problem persists, contact a service center. The number of the service center is on the label attached to the product.

Information codes

If there is any problem, check the information message on the LCD screen and follow the on-screen instructions.

Problem	Code	Action
Check drainage	5C	<ul style="list-style-type: none"> The Laundry Combo isn't draining properly. Clean the drain filter, then tap Start to restart the Laundry Combo. Or, turn it off and on again after 2-3 minutes, then try again. <p> NOTE If you perform the Condenser Cleaning function without connecting the water supply hose, you may see the 5C code on the LCD display. In this case, please check the drainage and water supply status.</p>
Check water supply	4C	<ul style="list-style-type: none"> Water isn't being supplied properly. Check the faucets, then tap Start to restart the Laundry Combo. Or, turn it on and off again after 2-3 minutes, then try again.
Please connect the hot/cold water hose connection correctly	4C2	<ul style="list-style-type: none"> The water is too hot. Some fabrics need to be protected. Check if the water supply hoses are properly connected, then tap Start to restart the Laundry Combo. Or, turn it off and on again after 2-3 minutes and try again.
Incorrect button state	BC2	<ul style="list-style-type: none"> A button on the Laundry Combo is still pressed in. Turn off the Laundry Combo, then turn it on again after 2-3 minutes and try again.
Open the door and evenly distribute the load	UB	<ul style="list-style-type: none"> The spin dry isn't performing properly. There isn't enough laundry or the load is unbalanced. Add more laundry or redistribute the items, then tap Start to restart the Laundry Combo. Or, turn it off and on again after 2-3 minutes, then try again.
Waterproof items detected	UB1	<ul style="list-style-type: none"> Your laundry contains waterproof items. Remove those items, then tap Start to restart the Laundry Combo. Or, turn it off and on again after 2-3 minutes, then try again.
Door is open	DC	<ul style="list-style-type: none"> The door is open. Close it and try again.
Close the washer door and try again	DC6	<ul style="list-style-type: none"> Auto open door isn't working properly. If you turn off the power, the door will open. To use Auto open door, turn off Lock and Smart control in SmartThings.

Troubleshooting

Problem	Code	Action
The door switch lock/ unlock is not working properly.	DC1	<ul style="list-style-type: none">• Turn off the Laundry Combo, then turn it on again after 2-3 minutes and try again.
		<ul style="list-style-type: none">• The door switch isn't working properly.• Check for foreign substances around the door, then push the door closed and try again.
Check filter is inserted correctly	NC	<ul style="list-style-type: none">• Check if the filter is inserted correctly, then tap Start to restart the Laundry Combo. Or, turn it off and on again after 2-3 minutes, then try again.





If any information code keeps appearing on the screen, contact a local Samsung service center.

Specifications



Fabric care chart

The following symbols provide garment care direction. The clothing care labels include symbols for drying, bleaching, drying and ironing, or dry cleaning when necessary. The use of symbols ensures consistency among garment manufacturers of domestic and imported items. Follow care label directions to optimize garment life and reduce laundering problems.

Wash cycle

	Normal
	Permanent press/Wrinkle resistant/ Wrinkle control
	Gentle/Delicates
	Hand wash



Water temperature

	Hot
	Warm
	Cold



NOTE

The temperature range for Hot is 135 °F (57 °C) or below, 95 °F (35 °C) or below for Warm, and 68 °F (20 °C) or below for Cold. Wash water temperature must be a minimum of 60 °F (16 °C) for detergent activation and effective cleaning.



Bleach

	Any bleach (when needed)
	Only non-chlorine (color-safe) bleach (when needed)
	Tumble dry





Normal

	Permanent press/Wrinkle resistant/ Wrinkle control
	Gentle/Delicates



Special instructions

	Line dry/Hang to dry
	Drip dry
	Dry flat

Heat setting







	High
	Medium
	Low
	Any heat
	No heat / Air

Iron dry or steam temperatures





	High
	Medium
	Low

Specifications

Warning symbols for laundering

	Do not wash
	Do not wring
	Do not bleach
	Do not tumble dry
	No steam (added to iron)
	Do not iron

Dry-clean

	Dry-clean
	Do not dry-clean
	Line dry/Hang to dry
	Drip dry
	Dry flat

Protecting the environment

- This appliance is manufactured from recyclable materials. If you decide to dispose of it, please observe local waste disposal regulations. Cut off the power cord so that the appliance cannot be connected to a power source. Remove the lid so that animals and small children cannot get trapped inside the appliance.
- Do not exceed the detergent quantities recommended in the detergent manufacturers' instructions.
- Use stain removal products and bleaches before the wash cycle only when necessary.
- Save water and electricity by only washing full loads (the exact amount depends upon the program used).

Declaration of conformity

This appliance complies with UL2157.

Specification sheet

Type		Front loading washer	
		WD53DBA9**H*	
Water pressure (psi (kPa))		20-116 (137-800)	
NET weight (lb (kg))		317 (144.0)	
Spin revolution		1150 rpm	
Heating rating		900 W	
Power consumption	Washing	120 V	200 W
	Washing and heating		1400 W
	Spin		550 W
	Drain		80 W

NOTE

You can fill the tub with dry, unfolded clothes, but DO NOT OVERLOAD the tub.

LIMITED WARRANTY (U.S.A.)

SAMSUNG WASHER

LIMITED WARRANTY TO ORIGINAL CONSUMER PURCHASER WITH PROOF OF PURCHASE AND/OR PROOF OF DELIVERY

This SAMSUNG brand product, as supplied and distributed by SAMSUNG ELECTRONICS AMERICA, INC. (SAMSUNG) and delivered new, in the original carton to the original consumer purchaser, is warranted by SAMSUNG against manufacturing defects in materials or workmanship for the following limited warranty periods, starting on the date of delivery to the original consumer purchaser:

Parts and labor: One (1) year

Stainless tub part (Part Only) : Three (3) years

Washing DIT (Digital Inverter Motor) motor part (Part Only):

- Twenty (20) years

This limited warranty is valid only on products purchased and used in the United States that have been installed, operated, and maintained according to the instructions attached to or furnished with the product. To receive warranty service, the purchaser must contact SAMSUNG at the address or phone number provided below for problem determination and service procedures. Warranty service can only be performed by a SAMSUNG authorized service center. The original dated bill of sale and/or proof of delivery must be presented upon request to SAMSUNG or SAMSUNG's authorized service center to receive warranty service.

SAMSUNG will provide in-home service within the contiguous United States during the warranty period at no charge, subject to availability of SAMSUNG authorized servicers within the customer's geographic area. If in-home service is not available, SAMSUNG may elect, at its option, to provide transportation of the product to and from an authorized service center. If the product is located in an area where service by a SAMSUNG authorized servicer is not available, you may be responsible for a trip charge or required to bring the product to a SAMSUNG authorized service center for service.

To receive in-home service, product must be unobstructed and accessible to the service agent.

During the applicable warranty period, a product will be repaired, replaced, or the purchase price refunded, at the sole option of SAMSUNG. SAMSUNG may use new or reconditioned parts in repairing a product, or replace the product with a new or reconditioned product. Replacement parts and products are warranted for the remaining portion of the original product's warranty or ninety (90) days, whichever is longer. All replaced parts and products are the property of SAMSUNG and you must return them to SAMSUNG.

This limited warranty covers manufacturing defects in materials or workmanship encountered in normal household, noncommercial use of this product and shall not cover the following: damage that occurs in shipment, delivery, installation, and uses for which this product was not intended; damage caused by unauthorized modification or alteration of the product; product where the original factory serial numbers have been removed, defaced, changed in any way, or cannot be readily determined; cosmetic damage including scratches, dents, chips, and other damage to the product's finishes; damage caused by abuse, misuse, pest infestations, accident, fire, floods, or other acts of nature or God; damage caused by use of equipment, utilities, services, parts, supplies, accessories, applications, installations, repairs, external wiring or connectors not supplied or authorized by SAMSUNG; damage caused by incorrect electrical line current, voltage, fluctuations and surges; damage caused by failure to operate and maintain the product according to instructions; in-home instruction on how to use your product; and service to correct installation not in accordance with electrical or plumbing codes or correction of household electrical or plumbing (i.e., house wiring, fuses, or water inlet hoses). The cost of repair or replacement under these excluded circumstances shall be the customer's responsibility.

Visits by an authorized servicer to explain product functions, maintenance or installation are not covered by this limited warranty. Please contact SAMSUNG at the number below for assistance with any of these issues.

EXCLUSION OF IMPLIED WARRANTIES

IMPLIED WARRANTIES, INCLUDING THE IMPLIED WARRANTIES OF MERCHANTABILITY OR FITNESS FOR A PARTICULAR PURPOSE, ARE LIMITED TO ONE YEAR OR THE SHORTEST PERIOD ALLOWED BY LAW.

Some states do not allow limitations on how long an implied warranty lasts, so the above limitations or exclusions may not apply to you. This warranty gives you specific rights, and you may also have other rights, which vary from state to state.

LIMITED WARRANTY (U.S.A.)

LIMITATION OF REMEDIES

YOUR SOLE AND EXCLUSIVE REMEDY IS PRODUCT REPAIR, PRODUCT REPLACEMENT, OR REFUND OF THE PURCHASE PRICE AT SAMSUNG'S OPTION, AS PROVIDED IN THIS LIMITED WARRANTY. SAMSUNG SHALL NOT BE LIABLE FOR SPECIAL, INCIDENTAL OR CONSEQUENTIAL DAMAGES, INCLUDING BUT NOT LIMITED TO TIME AWAY FROM WORK, HOTELS AND/OR RESTAURANT MEALS, REMODELING EXPENSES, LOSS OF REVENUE OR PROFITS, FAILURE TO REALIZE SAVINGS OR OTHER BENEFITS REGARDLESS OF THE LEGAL THEORY ON WHICH THE CLAIM IS BASED, AND EVEN IF SAMSUNG HAS BEEN ADVISED OF THE POSSIBILITY OF SUCH DAMAGES. Some states do not allow exclusion or limitation of incidental or consequential damages, so the above limitations or exclusions may not apply to you. This warranty gives you specific rights, and you may also have other rights, which vary from state to state.

SAMSUNG does not warrant uninterrupted or error-free operation of the product. No warranty or guarantee given by any other person, firm, or corporation with respect to this product shall be binding on SAMSUNG.

To obtain warranty service, please contact SAMSUNG at:

Samsung Electronics America, Inc.

85 Challenger Road

Ridgefield Park, NJ 07660

1-800-SAMSUNG (726-7864)

www.samsung.com/us/support

Warranty (CANADA)

SAMSUNG WASHER

LIMITED WARRANTY TO ORIGINAL PURCHASER

This SAMSUNG brand product, as supplied and distributed by SAMSUNG ELECTRONICS CANADA, INC. (SAMSUNG) and delivered new, in the original carton to the original consumer purchaser, is warranted by SAMSUNG against manufacturing defects in materials and workmanship for a limited warranty period of:

Parts and labor : One (1) year

Washing DIT (Digital Inverter Motor) motor part (Part Only):

- Twenty (20) years

This limited warranty begins on the original date of purchase, and is valid only on products purchased and used in the Canada. To receive warranty service, the purchaser must contact SAMSUNG for problem determination and service procedures. Warranty service can only be performed by a SAMSUNG authorized service center. The original dated bill of sale must be presented upon request as proof of purchase to SAMSUNG or SAMSUNG's authorized service center. SAMSUNG will provide in-home service during the warranty period at no charge, subject to availability within the Canada. In-home service is not available in all areas.

To receive in-home service, product must be unobstructed and accessible to the service agent. If service is not available, SAMSUNG may elect to provide transportation of the product to and from an authorized service center.

SAMSUNG will repair, replace, or refund this product at our option and at no charge as stipulated herein, with new or reconditioned parts or products if found to be defective during the limited warranty period specified above. All replaced parts and products become the property of SAMSUNG and must be returned to SAMSUNG. Replacement parts and products assume the remaining original warranty, or ninety (90) days, whichever is longer. This limited warranty covers manufacturing defects in materials and workmanship encountered in normal, noncommercial use of this product and shall not apply to the following: damage that occurs in shipment; delivery and installation; applications and uses for which this product was not intended; altered product or serial numbers; cosmetic damage or exterior finish; accidents, abuse, neglect, fire, water, lightning, or other acts of nature or God; use of products, equipment, systems, utilities, services, parts, supplies, accessories, applications, installations, repairs, external wiring or connectors not supplied or authorized by SAMSUNG that damage this product or result in service problems; incorrect electrical line voltage, fluctuations and surges; customer adjustments and failure to follow operating instructions, maintenance and environmental instructions that are covered and prescribed in the instruction book; product removal and reinstallation; problems caused by pest infestations. This limited warranty does not cover problems resulting from incorrect electric current, voltage or supply, light bulbs, house fuses, house wiring, cost of a service call for instructions, or fixing installation errors. SAMSUNG does not warranty uninterrupted or error-free operation of the product.

EXCEPT AS SET FORTH HEREIN, THERE ARE NO WARRANTIES ON THIS PRODUCT EITHER EXPRESS OR IMPLIED, AND SAMSUNG DISCLAIMS ALL WARRANTIES INCLUDING, BUT NOT LIMITED TO, ANY IMPLIED WARRANTIES OF MERCHANTABILITY, INFRINGEMENT OR FITNESS FOR A PARTICULAR PURPOSE.

Warranty (CANADA)

NO WARRANTY OR GUARANTEE GIVEN BY ANY PERSON, FIRM, OR CORPORATION WITH RESPECT TO THIS PRODUCT SHALL BE BINDING ON SAMSUNG. SAMSUNG SHALL NOT BE LIABLE FOR LOSS OF REVENUE OR PROFITS, FAILURE TO REALIZE SAVINGS OR OTHER BENEFITS, OR ANY OTHER SPECIAL, INCIDENTAL OR CONSEQUENTIAL DAMAGES CAUSED BY THE USE, MISUSE, OR INABILITY TO USE THIS PRODUCT, REGARDLESS OF THE LEGAL THEORY ON WHICH THE CLAIM IS BASED, AND EVEN IF SAMSUNG HAS BEEN ADVISED OF THE POSSIBILITY OF SUCH DAMAGES.

NOR SHALL RECOVERY OF ANY KIND AGAINST SAMSUNG BE GREATER IN AMOUNT THAN THE PURCHASE PRICE OF THE PRODUCT SOLD BY SAMSUNG AND CAUSING THE ALLEGED DAMAGE. WITHOUT LIMITING THE FOREGOING, PURCHASER ASSUMES ALL RISK AND LIABILITY FOR LOSS, DAMAGE, OR INJURY TO PURCHASER AND PURCHASER'S PROPERTY AND TO OTHERS AND THEIR PROPERTY ARISING OUT OF THE USE, MISUSE, OR INABILITY TO USE THIS PRODUCT. THIS LIMITED WARRANTY SHALL NOT EXTEND TO ANYONE OTHER THAN THE ORIGINAL PURCHASER OF THIS PRODUCT, IS NONTRANSFERABLE AND STATES YOUR EXCLUSIVE REMEDY.

Some provinces do not allow limitations on how long an implied warranty lasts, or the exclusion or limitation of incidental or consequential damages, so the above limitations or exclusions may not apply to you.

This warranty gives you specific rights, and you may also have other rights, which vary from province to province.

To obtain warranty service, please contact SAMSUNG at:

Samsung Electronics Canada Inc.

2050 Derry Road West,

Mississauga, Ontario L5N 0B9 Canada

1-800-SAMSUNG (726-7864)

www.samsung.com/ca/support (English)

www.samsung.com/ca_fr/support (French)

FAX : 1-866-436-4617

Visits by a Service Engineer to explain functions, maintenance, or installation are not covered by warranty.

Please contact your Samsung call agent for help with any of these issues.

Memo



For Washer Only



For Dryer Only

This product qualifies for ENERGY STAR in the factory default "**Normal**" setting.

If you change the factory default setting or enable other features, power consumption could increase and exceed the limits qualified for ENERGY STAR.



Scan the QR code* or visit
www.samsung.com/spsn
to view our helpful
How-to Videos and Live Shows

*Requires reader to be installed on your smartphone

Scan this with your smartphone

QUESTIONS OR COMMENTS?

COUNTRY	CALL	OR VISIT US ONLINE AT
U.S.A	1-800-SAMSUNG (726-7864)	www.samsung.com/us/support
CANADA	1-800-SAMSUNG(726-7864)	www.samsung.com/ca/support (English) www.samsung.com/ca_fr/support (French)